

PROJECT : _____
 SALE : _____

Lampitude

Product



Dimension

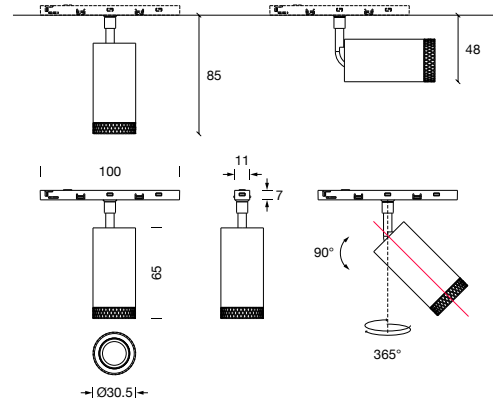

Specification

SERIES	: MINI-TRACK
ITEM CODE	: MINI-TRACK-30-5.3W-18/31D-3000K-BK
DESCRIPTION	: MINI TRACK LIGHT
SIZE	: Ø30.5 X H85 (MM)
INSTALLATION	: TRACK MOUNTED
DRILL SIZE	: -
WEIGHT	: 0.08 KG
MATERIAL	: ALUMINUM , PC
COLOR	: BLACK
REFLECTOR	: -
DIFFUSER	: -
IP RATING	: 20
LIGHT SOURCES	: LED COB
SOCKET	: -
WATTS	: 5.3W
INPUT VOLTAGE	: DC 48V
CCT	: 3000K
CRI	: >90
BEAM ANGLE	: 18-31°
LUMEN POWER	: 155-333 LM
LIFETIME	: 35,000 Hrs
CONTROL GEAR	: -
ACCESSORIES	: -
REMARKS	: TRACK NOT INCLUDED

Head office 299/1 (Ekamai) Klongton-Nua, Wattana, Bangkok Thailand 10110

Tel (02) 392 6371-5 FAX (02) 392 1839 Email info@lamptitude.net www.lamptitude.com

PROJECT : _____
SALE : _____

Lampitude

Accessories

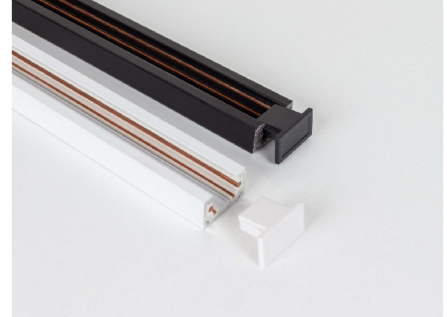
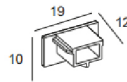
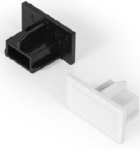

DESCRIPTION END CAP
ITEM CODE MINI-TRACK-END-CP-BK (สีดำ) / MINI-TRACK-END-CAP-WH (สีขาว)
REMARK 2 PCS/ SET (NEED THIS PART)

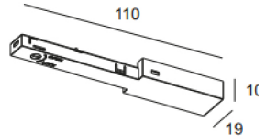

DESCRIPTION ELECTRICAL FEEDER PART
ITEM CODE MINI-TRACK-FEEDER-BK (สีดำ) / MINI-TRACK-FEEDER-WH (สีขาว)
REMARK WITH 45 CM. CABLE (NEED THIS PART)

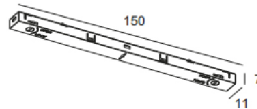

DESCRIPTION LINEAR TRACK CONNECTOR
ITEM CODE MINI-TRACK-I-LINEAR-BK (สีดำ) / MINI-TRACK-I-LINEAR-WH (สีขาว)
REMARK NEED FOR STRAIGHT CONNECT

Head office 299/1 (Ekamai) Klongton-Nua, Wattana, Bangkok Thailand 10110

Tel (02) 392 6371-5 FAX (02) 392 1839 Email info@lamplitude.net www.lamplitude.com

PROJECT : _____
 SALE : _____

Accessories

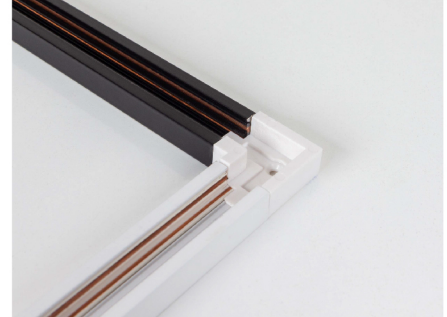
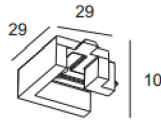
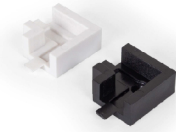

DESCRIPTION L CONNECTOR FIXING PART
ITEM CODE MINI-TRACK-L-CONNECTOR-BK (สีดำ) / MINI-TRACK-L-CONNECTOR-WH (สีขาว)
REMARK USE WITH MINI-TRACK-L-LINEAR

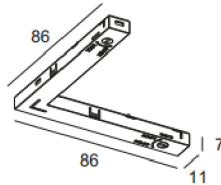

DESCRIPTION L CONNECTOR
ITEM CODE MINI-TRACK-L-LINEAR-BK (สีดำ) / MINI-TRACK-L-LINEAR-WH (สีขาว)
REMARK USE WITH MINI-TRACK-L-CONNECTOR

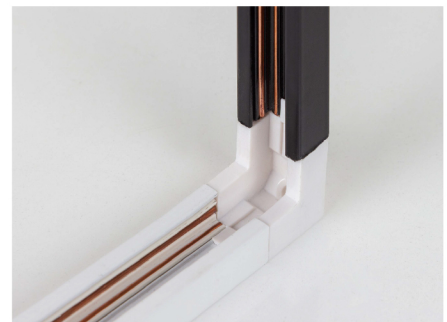
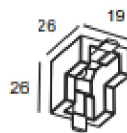
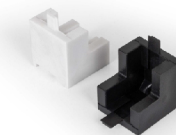

DESCRIPTION VERTICAL CORNER CONNECTOR FIXING PART
ITEM CODE MINI-TRACK-V-CONNECTOR-BK (สีดำ) / MINI-TRACK-V-CONNECTOR-WH (สีขาว)
REMARK USE WITH MINI-TRACK-V-LINEAR

PROJECT : _____
 SALE : _____



Accessories

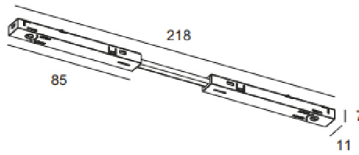

DESCRIPTION L CONNECTOR FIXING PART
ITEM CODE MINI-TRACK-L-CONNECTOR-BK (สีดำ) / MINI-TRACK-L-CONNECTOR-WH (สีขาว)
REMARK USE WITH MINI-TRACK-L-LINEAR

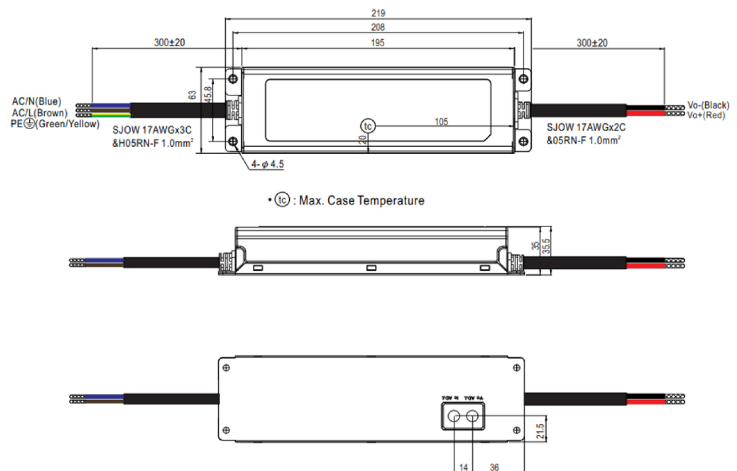

DESCRIPTION	POWER SUPPLY	HARMONIC (THD)	<20%
ITEM CODE	CGPS-ELG-150W-48A-MW	INPUT VOLTAGE	AC 100-305V , 47-63 Hz
WEIGHT	0.95 KG	OUTPUT VOLTAGE	DC 48V
MATERIAL	METAL	OUTPUT CURRENT	3.13A
IP RATING	IP65	AMBIENT TEMPERATURE	40°C to 55°C
RATED POWER	MAX 150W	LIFE TIME	35,000 - 50,000 Hrs
POWER FACTOR (PF)	0.9		

Head office 299/1 (Ekamai) Klongton-Nua, Wattana, Bangkok Thailand 10110

Tel (02) 392 6371-5 FAX (02) 392 1839 Email info@lamptitude.net www.lamptitude.com