

PROJECT : \_\_\_\_\_  
SALE : \_\_\_\_\_

# Lampitude

## Product



## Dimension

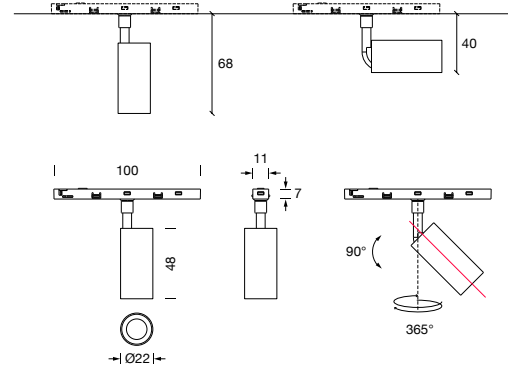

## Specification

**SERIES** : MINI-TRACK  
**ITEM CODE** : MINI-TRACK-22-1.3W-18D-3000K-BK  
**DESCRIPTION** : MINI TRACK LIGHT  
**SIZE** : Ø22 X H68 (MM)

**INSTALLATION** : TRACK MOUNTED  
**DRILL SIZE** : -  
**WEIGHT** : 0.04 KG  
**MATERIAL** : ALUMINUM , PC  
**COLOR** : BLACK  
**REFLECTOR** : -  
**DIFFUSER** : -  
**IP RATING** : 20

**LIGHT SOURCES** : LED SMD  
**SOCKET** : -  
**WATTS** : 1.3W  
**INPUT VOLTAGE** : DC 48V  
**CCT** : 3000K  
**CRI** : >90  
**BEAM ANGLE** : 18°  
**LUMEN POWER** : 80 LM  
**LIFETIME** : 35,000 Hrs

**CONTROL GEAR** : -  
**ACCESSORIES** : -  
**REMARKS** : TRACK NOT INCLUDED

Head office 299/1 (Ekamai) Klongton-Nua, Wattana, Bangkok Thailand 10110

Tel (02) 392 6371-5 FAX (02) 392 1839 Email info@lamptitude.net www.lamptitude.com

PROJECT : \_\_\_\_\_  
 SALE : \_\_\_\_\_

## Accessories

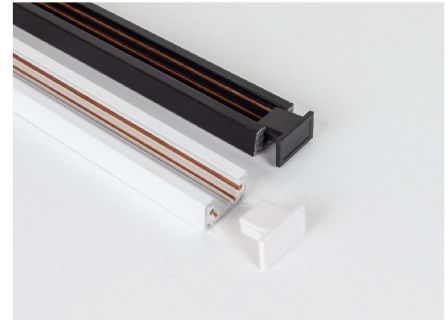
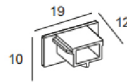
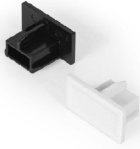

**DESCRIPTION** END CAP  
**ITEM CODE** MINI-TRACK-END-CP-BK (สีดำ) / MINI-TRACK-END-CAP-WH (สีขาว)  
**REMARK** 2 PCS/ SET (NEED THIS PART)

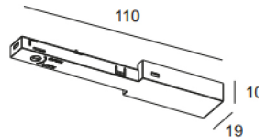

**DESCRIPTION** ELECTRICAL FEEDER PART  
**ITEM CODE** MINI-TRACK-FEEDER-BK (สีดำ) / MINI-TRACK-FEEDER-WH (สีขาว)  
**REMARK** WITH 45 CM. CABLE (NEED THIS PART)

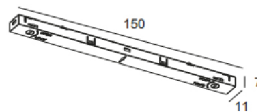

**DESCRIPTION** LINEAR TRACK CONNECTOR  
**ITEM CODE** MINI-TRACK-I-LINEAR-BK (สีดำ) / MINI-TRACK-I-LINEAR-WH (สีขาว)  
**REMARK** NEED FOR STRAIGHT CONNECT

PROJECT : \_\_\_\_\_

SALE : \_\_\_\_\_

# Lampitude

## Accessories

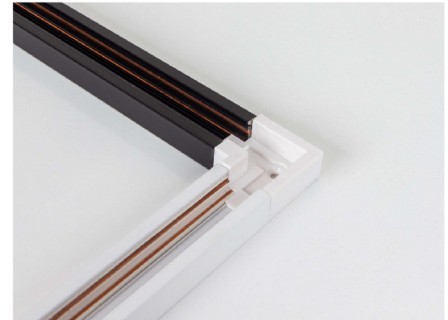
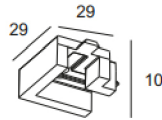
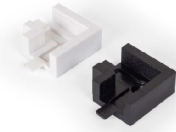

**DESCRIPTION** L CONNECTOR FIXING PART  
**ITEM CODE** MINI-TRACK-L-CONNECTOR-BK (สีดำ) / MINI-TRACK-L-CONNECTOR-WH (สีขาว)  
**REMARK** USE WITH MINI-TRACK-L-LINEAR

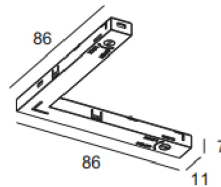
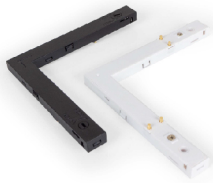

**DESCRIPTION** L CONNECTOR  
**ITEM CODE** MINI-TRACK-L-LINEAR-BK (สีดำ) / MINI-TRACK-L-LINEAR-WH (สีขาว)  
**REMARK** USE WITH MINI-TRACK-L-CONNECTOR

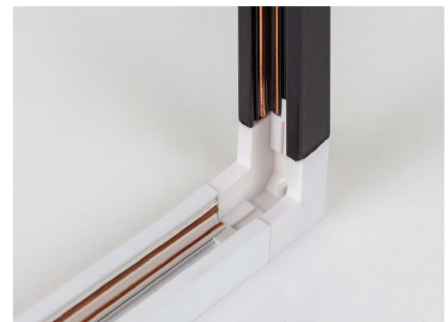
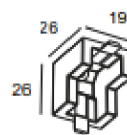
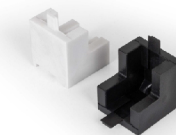

**DESCRIPTION** VERTICAL CORNER CONNECTOR FIXING PART  
**ITEM CODE** MINI-TRACK-V-CONNECTOR-BK (สีดำ) / MINI-TRACK-V-CONNECTOR-WH (สีขาว)  
**REMARK** USE WITH MINI-TRACK-V-LINEAR

Head office 299/1 (Ekamai) Klongton-Nua, Wattana, Bangkok Thailand 10110

Tel (02) 392 6371-5 FAX (02) 392 1839 Email info@lamptitude.net www.lamptitude.com

PROJECT : \_\_\_\_\_  
 SALE : \_\_\_\_\_

## Accessories

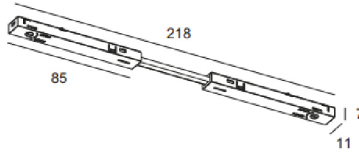

**DESCRIPTION** L CONNECTOR FIXING PART  
**ITEM CODE** MINI-TRACK-L-CONNECTOR-BK (สีดำ) / MINI-TRACK-L-CONNECTOR-WH (สีขาว)  
**REMARK** USE WITH MINI-TRACK-L-LINEAR

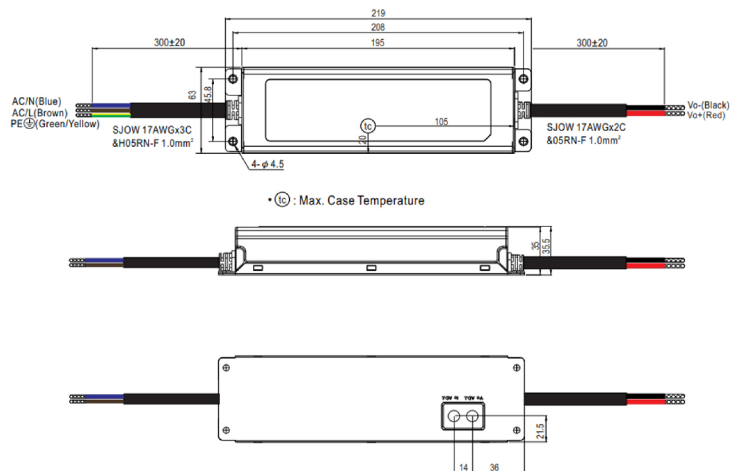

**DESCRIPTION** POWER SUPPLY  
**ITEM CODE** CGPS-ELG-150W-48A-MW  
**WEIGHT** 0.95 KG  
**MATERIAL** METAL  
**IP RATING** IP65  
**RATED POWER** MAX 150W  
**POWER FACTOR (PF)** 0.9

**HARMONIC (THD)** <20%  
**INPUT VOLTAGE** AC 100-305V , 47-63 Hz  
**OUTPUT VOLTAGE** DC 48V  
**OUTPUT CURRENT** 3.13A  
**AMBIENT TEMPERATURE** 40°C to 55°C  
**LIFE TIME** 35,000 - 50,000 Hrs