

PROJECT : _____
SALE : _____

Lampitude

Product

Dimension

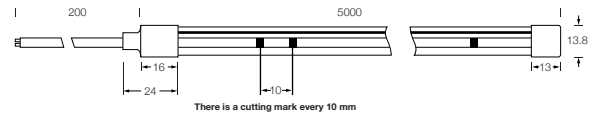

Specification

SERIES	: LTE-NEONFLEX
ITEM CODE	: LTE-NEONFLEX-940-9W-CW
DESCRIPTION	: FLEXIBLE STRIP LIGHT
SIZE	: W6 X H12 X L5000 (MM)
INSTALLATION	: SURFACE MOUNTED WALL
CUTTING MARK	: 10 (MM)
WEIGHT	: 0.5 KG
MATERIAL	: SILICONE RUBBER
COLOR	: WHITE
REFLECTOR	: -
DIFFUSER	: -
IP RATING	: 67
LIGHT SOURCES	: LED
WATTS	: 9W / METER
INPUT VOLTAGE	: 24V DC
INPUT CURRENT	: 375 mA
CCT	: 4000K
CRI	: 90
BEAM ANGLE	: 110°
LUMEN POWER	: 140LM / M
AMBIENT TEMP	: -20°C TO +40°C
LIFETIME	: 36,000 Hrs
CONTROL GEAR	: LED POWER SUPPLY NOT INCLUDED
ACCESSORIES	: NOT INCLUDED
REMARKS	: DIMMABLE (DEPENDS NOT INCLUDED)

Head office 299/1 (Ekamai) Klongton-Nua, Wattana, Bangkok Thailand 10110

Tel (02) 392 6371-5 FAX (02) 392 1839 Email info@lamptitude.net www.lamptitude.com

PROJECT : _____

SALE : _____

Lamptitude

Accessories



DESCRIPTION FRONT CAP
ITEM CODE SPAC-NEONFLEX-I-FRONT CAP



DESCRIPTION FRONT CAP (L-SHAPE)
ITEM CODE SPAC-NEONFLEX-L-FRONT CAP



DESCRIPTION END CAP
ITEM CODE SPAC-NEONFLEX-END CAP



DESCRIPTION ALUMINIUM CLIP
ITEM CODE SPAC-NEONFLEX-CLIPLOCK



DESCRIPTION CONNECTOR
ITEM CODE SPAC-NEONFLEX-CONNECTOR



DESCRIPTION SILICONE GLUE
ITEM CODE SPAC-NEONFLEX-GUMFILLER

Head office 299/1 (Ekamai) Klongton-Nua, Wattana, Bangkok Thailand 10110

Tel (02) 392 6371-5 FAX (02) 392 1839 Email info@lamptitude.net www.lamptitude.com

PROJECT : _____

SALE : _____

Accessories

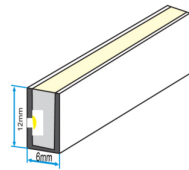

Section Drawing

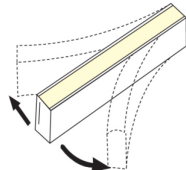

Bending Direction

Correct



Min: ϕ 30 mm

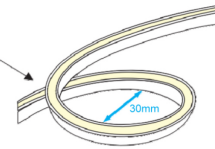

Incorrect

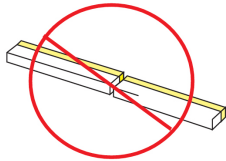

cutting profile should be flat

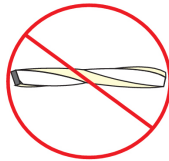

no twisting

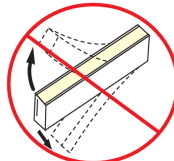

no bending up and
down the light surface

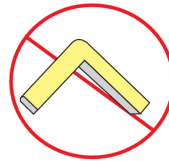

no 90° bending



no bending repeatedly

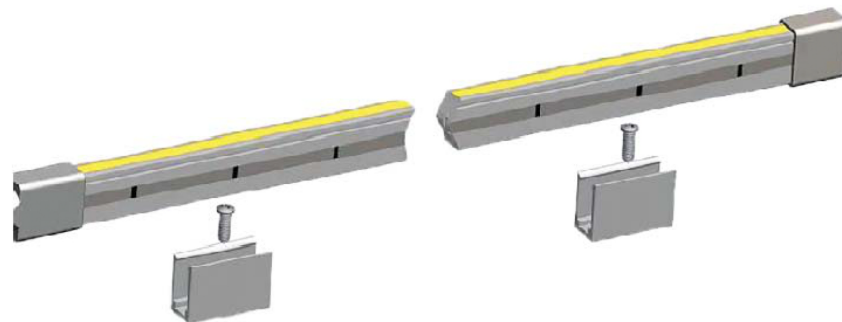

- 1、 to fix the clips onto the mounting surface, 3 pcs per meter recommended;
- 2、 to fix the neon strip into the clips

PROJECT : _____
SALE : _____

Accessories

WIRING DIAGRAM

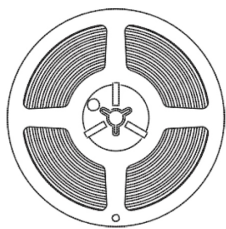
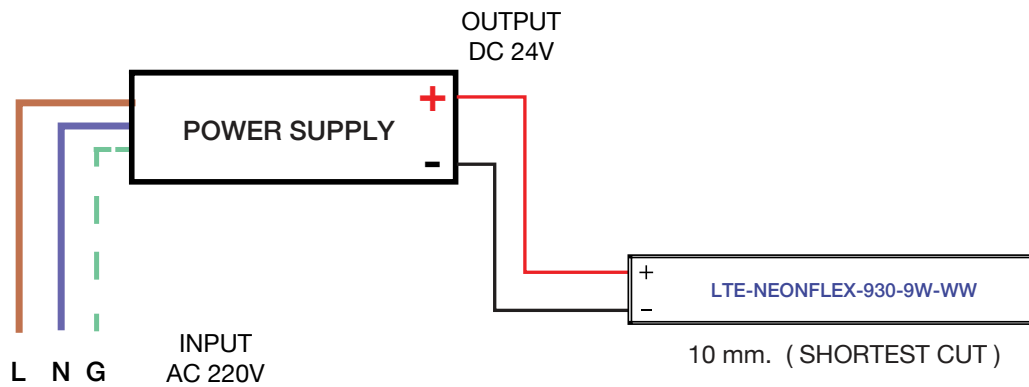

12 inch *12 mm
Standard Length: 5 meters /roll

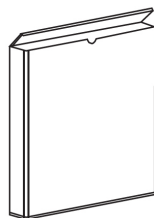
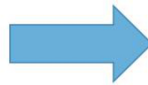

309*308*38 mm
2 rolls per box

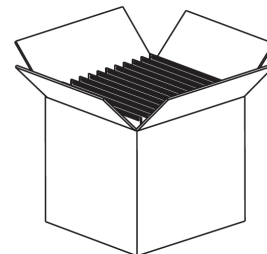

405*320*328 mm
10 boxes per carton
Gross weight: 18 kgs