

**APOLLO**<sup>®</sup>  
S P R A Y

# **E7000 Spray Gun Instruction Manual**



This manual contains important warnings and instructions.

Please read these instructions carefully and keep for your reference.

©2023 Apollo Sprayers International, Inc.

## Table of Contents

1. Safety.....	2
2. E5011 HVLP Spray Guns.....	3
3. How Your E5011 Spray Gun Works .....	3
4. E5011 Spray Gun Cup .....	3-4
5. Operating Your E5011 Spray Gun.....	5
5.1. Knowing Your Coating.....	5-6
5.2. Spray Gun Technique.....	6-7
5.3. Air Pressure and Viscosity .....	7-8
6. Cleaning Your E5011 Spray Gun.....	8-9
7. Record of Spray Gun Use.....	10
8. Record of Spray Gun Maintenance.....	10
9. Troubleshooting.....	10-11
10. Spray Gun Diagram.....	12
11. Warranty.....	13

# 1. WARNING

**\*DO NOT USE EQUIPMENT BEFORE READING THIS SECTION\***

**In order to assure safe operation of your spray system, please read the following instructions carefully.**

- Always follow solution manufacturer's safety instructions and warnings.
- Always spray in a well-ventilated area.
- We recommend that you use an approved face mask
- Always store indoors, never allow unit to freeze.
- Always use original manufacturers replacement parts
- Never spray flammable materials
- Never alter or modify any part of this equipment; doing so can cause equipment malfunction and/or bodily injury.
- Never attempt to clean any part of the turbine motor while it is plugged in.
- CAUTION: TO REDUCE THE RISK OF ELECTRIC SHOCK, DO NOT EXPOSE TO WATER.
- Never leave spray equipment unattended. Keep away from children or any person not familiar with spray equipment.

CONGRATULATIONS! You have just purchased the finest HVLP Spray system available. You are about to enjoy the great benefits of **TrueHVLP™** spraying, flawless applications and a very short learning curve. Our designs are the result of many years' experience in manufacturing **TrueHVLP™** Turbine spray systems, and **TrueHVLP™** spray guns.

Whether you are new to spraying, you have sprayed before, or are just new to HVLP spraying; there are some basic spraying guidelines that will help you to achieve the best results and optimum success from your new equipment. Reading this information carefully and following these simple steps will ensure that you get the best performance and results from your new spray system.

## **INSTRUCTIONS**

Check the contents of your box. The following are included:

1. Spray Gun
2. Parts Kit with wrench (spanner)
3. Instruction Manual

### **HOW YOU'RE ECO SERIES TRUEHVLP™ SPRAY SYSTEM WORKS**

Your **Apollo ECO Series TrueHVLP™ Spray System** has three components: the turbine unit, an air hose and the spray gun. The Turbine unit, when connected to the correct electrical power supply and with the on/off switch in the "on" position provides a continuous source of clean, warm, dry, low-pressure turbo air. The air hose connects the Turbine unit to the spray gun. Air flows through the hose to the nozzle of the specially designed **Apollo ECO** spray gun. Atomization of the material/coating is achieved when the high CFM of airflow mixes with the stream of fluid passing through the specialty designed tip/nozzle. This low-pressure atomization principle achieves minimum misting (overspray) to the spray environment and maximum solution transfer efficiency to the substrate because of less "Bounce Back". The Turbine has one air hose outlet on the side of the unit and is designed to run one spray gun.

## Bounce Back Comparisons

### Conventional Spray Systems

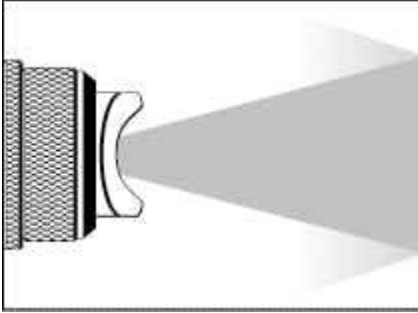

#### Conventional spray systems:

- 12-20 PSI @ 8 CFM
- 30-50% transfer efficiency
- Excessive, costly Solution waste
- Unhealthy for operator and harmful to the environment

### Apollo ECO TrueHVLPTM Spray System

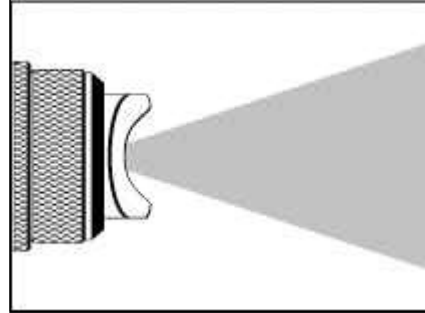

#### TrueHVLPTM Spray System

- 7.0 PSI @ 85 CFM
- Up to 90% transfer efficiency
- Substantial Solution savings
- Cleaner and safer for both operator and environment

**E7000** spray gun offers you many options. You can turn the air cap (#1-2) to two positions. One will produce a horizontal pattern for spraying across, another will produce a vertical pattern for spraying up and down.

### PREPARING TO USE YOUR ECO SPRAY SYSTEM

Connect the air hose to the Turbine, pull back the spring-loaded quick disconnect coupler and insert the male connector on the air hose into the turbine connector. Release the ring. Your air hose will be locked into place. To disconnect, pull back on the connector to release the air hose. **CAUTION:** If you have just finished spraying, the metal coupler at the turbine end may be hot.

Plug the electric cord into a correctly grounded electrical outlet. Be sure the electric current is the correct voltage. If you need to use an extension cord, be sure it is at least 12-gauge wire and has a correctly grounded outlet. (240v units for use outside of the United States are often only supplied with an electric cord. A correct plug must be installed prior to use. Make sure the ground wire is properly connected).

Select a safe, well-ventilated area where you will spray your client. Locate your Turbine unit away from the area where you will be directly spraying.

### FAMILIARIZING YOURSELF WITH YOUR APOLLO E7000 SPRAY GUN

Familiarize yourself with the controls on the spray gun. There are three principal controls: The rotating air cap (#1-2); the Material Adjustment Screw (#21); and the Fan Pattern Adjustment Knob (#11). Loosen the Air Cap Ring (#1-1) slightly to turn the rotating air cap to each position, Horizontal and Vertical. The horizontal position will give you a vertical fan pattern. The vertical position will give you a horizontal fan pattern.

The Fan Pattern Adjustment Knob (#11) will allow you to achieve the round pattern. To obtain the round pattern turn the knob so that it is in the horizontal position. When the knob is in the horizontal position the spray gun will only give you a round pattern. This is useful for spraying small, narrow areas or touching up a small area. When the knob is in the vertical position you will only get a fan pattern.

**NOTE:** It is sometimes necessary to lubricate the end of the air adjusting knob with some lithium grease. Do not use too much or it may contaminate your air supply. Remove the screw on the top of the spray head and pull the air adjusting knob out. At the very end of the shaft put some lubricant on the outer surface. This will help it slide smoothly when twisted back and forth inside the spray head.

Next, turn the Material Adjustment Screw (#21) anti- or counter-clockwise to open or release more fluid, clockwise to reduce or close material flow. **NOTE:** If you are using the round fan pattern it is usually necessary to reduce the amount of fluid.

## PREPARING TO SPRAY

You should now be ready to spray your project. Good quality results with your **Apollo ECO TrueHVLP™ Spray System** combination of careful preparation of your substrate, a proper spraying environment, a basic knowledge of the material/coating you will be using and how these materials work with your **Apollo ECO Series Turbine**.

## Using Your Apollo ECO Spray Gun

Your **Apollo ECO** Spray Gun is certified. This means your spray gun uses no more than 10 PSI. All passages and air ports are much larger than a conventional spray gun. If one of these air passages becomes blocked, or build up of material starts to occur, your spray pattern will become distorted, therefore, always keep your spray gun clean. The E7000 comes fitted with a 1.3mm nozzle (#3) and needle (#19). These sizes will effectively spray most wood coatings. Using these sizes of tip/nozzle and needle you can achieve a 1/4" line up to a 10" fan pattern, simply by rotating the air cap (#1) to the desired fan type, opening the material adjustment screw (#21) counter-clockwise and moving the spray gun closer or further away from your work piece. A little practice will enable you to master this technique in no time flat!

### PRACTICE:

**VERY IMPORTANT!!** Remove the cup from your spray gun by moving the lever on the top of the cup lid over to one side. Fill it approximately half way with some water. Reattach the cup to the body of the spray gun and lock down the lever to create a good seal. Attach the spray gun to the air hose and the other end of the air hose to the turbine. Turn the turbine unit on. The E7000 spray gun is a non-bleeder spray gun, which means you will not have any air flowing through the spray gun until you pull the trigger. The first stage of your pull will release the air. The second stage of your pull will release the fluid. Position the air cap (#1) in the horizontal or vertical position, turn the material adjustment screw (#21) clockwise until closed. Make a mark on the material flow screw at 12:00 (Noon), and then adjust the material flow screw to 8:00; this will give you a good starting point. Point the spray gun away from yourself (and anyone else) and pull the trigger all the way back. You should see a "V" shaped mist (or triangle) called a fan pattern. Now, with the trigger depressed, if you turn the material flow screw, clockwise (closing), making very small adjustments at a time, you will notice that the fan pattern is beginning to get smaller. Now, reverse this and notice the pattern will get larger. Take a large piece of cardboard and direct the pattern at the surface, hold the spray gun approximately 6"-8" from the surface. Pull the trigger, observe the outline and size of the pattern. Now, turn the material flow screw clockwise (closing). Move the spray gun an inch or two closer to the surface. Pull the trigger. Notice the pattern has become smaller. You can continue reducing the material flow and move the spray gun even closer to the surface and the pattern will continue to get smaller and smaller. Next, turn the Fan Pattern Adjustment Knob (#11) to the horizontal position. Play with varying the material flow and the distance of the spray gun from the work surface. Notice the change in pattern size.

**Caution:** Even when the turbine unit is off, pressure will remain in the spray cup. If you pull the trigger back, a stream of fluid will flow. To prevent accidents, turn material adjustment screw (#21) clockwise until it is completely closed. The trigger is now locked in the closed position. You can also simply aim the gun at a towel and pull the trigger to release any pressure in the cup.

**Note:** It is not necessary to empty and clean your spray gun when you pause between applications. Be sure, however, to clean your spray gun thoroughly at the end of your work session. It is a bad idea to leave materials in your spray gun overnight.

## PROPER SPRAY TECHNIQUE

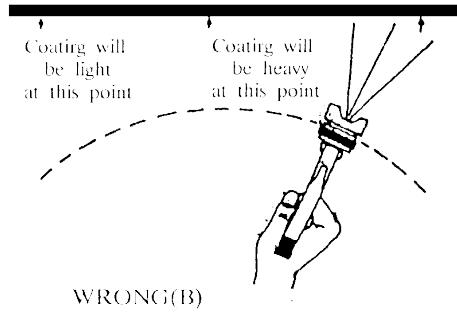
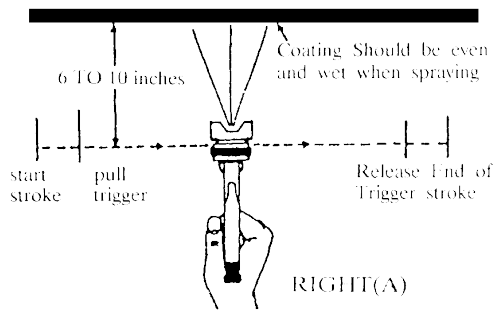

## SPRAY GUN MAINTENANCE AND CLEANING

You do not need to clean your spray gun every time you stop spraying. Either set the spray gun down carefully so as not to tip it over, or hang it by the hook provided on the spray gun. You should, however, clean your spray gun at the end of a work session or at the end of the day. It is not a good idea to leave material in the spray gun overnight. Also, pay careful attention in keeping the threads on the main gun body clean. Dried material on the threads can cause the parts to bind.

1. When you have finished spraying, pour the remainder of your material out of the spray gun cup. Pour in a small amount cleaning fluid. Use a cleaner that is compatible with the coating you just sprayed. (Water if product is water-soluble). Shake the spray gun gently. Wait about 30 seconds and spray out the cleaner in the cup. To protect the environment, you can spray the cleaner into a container or into a large rag that you have wadded into a large ball.
2. If necessary, remove the fluid nozzle (#3). Use the wrench provided to remove the fluid tip. Rinse with appropriate cleaner.
3. To remove the fluid needle assembly, turn the material adjustment screw (#21) all the way counter (anti) clockwise until it comes out of the spray gun. Carefully remove the needle return spring (#20). Pull the needle assembly back towards you and out of the spray gun. Wipe or rinse clean.
4. Wipe all exposed areas clean.
5. Although they might not need attention every time you spray, you should be aware of two additional important parts on your spray gun. One is the cup gasket (#11) and the gland seal (#26). The cup gasket insures that the cup is properly sealed to the spray gun body, the cup is properly pressurized and no fluid leaks from the spray gun cup. Replace if necessary. The gland seal is adjusted by tightening (or loosening) the gland nut (#27). Be sure that the gland nut is not too tight so that it does not allow free movement of the needle assembly. Be sure that this nut is not too loose as to permit fluid to leak around the needle. Normally, this is preset at the factory and should need no adjustment. Replace gland seal when it becomes impossible to prevent leaking.
6. Remove the fan pattern assembly shaft (#7A) by loosening the fan pattern retaining screw (#6). Add gun lubricant to the 3 areas designated by the arrows in the picture below. Once done, reinstall the shaft making sure to align the hole next to the knob with the hole for the fan pattern retaining screw. Reinsert the fan pattern retaining screw, but DO NOT tighten all the way. Only tighten until it is flush with the top of the gun body.

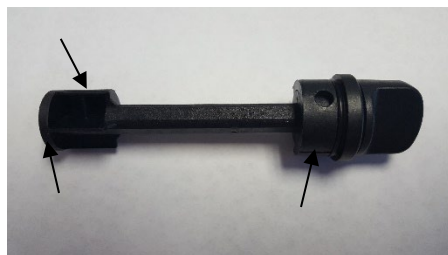

7. Store your spray gun for the next use.

Spray Gun Recommended Maintenance: Check: Cup gasket, gland seal, air cap holes, nozzle/needle assembly every 50 hours or when necessary. Clean or replace parts as needed.

## **TROUBLESHOOTING**

**1. Material cup full, turbine air is supplied to the spray gun. Trigger is pulled and no solution comes out - Reason: Cup not pressurizing.**

Check:

- A) Air Feed Tube/one way air valve
- B) Air Feed Connector
- C) Cup top gasket is not damaged.

**2. If you think that you are getting too much “overspray”.**

Try: Moving the spray gun closer to the work or closing down the fluid flow. Remember your spray system is designed to be used no more than 8”-10” away from your substrate. Make sure you are no further than that away when spraying and you should minimize your overspray.

Please feel free to call the factory if you have any additional question concerning cleaning or operation of your spray system. The factory’s toll free number is 1-888-900-HVLP (4857).



# E7000 Series HVLP Spray Gun

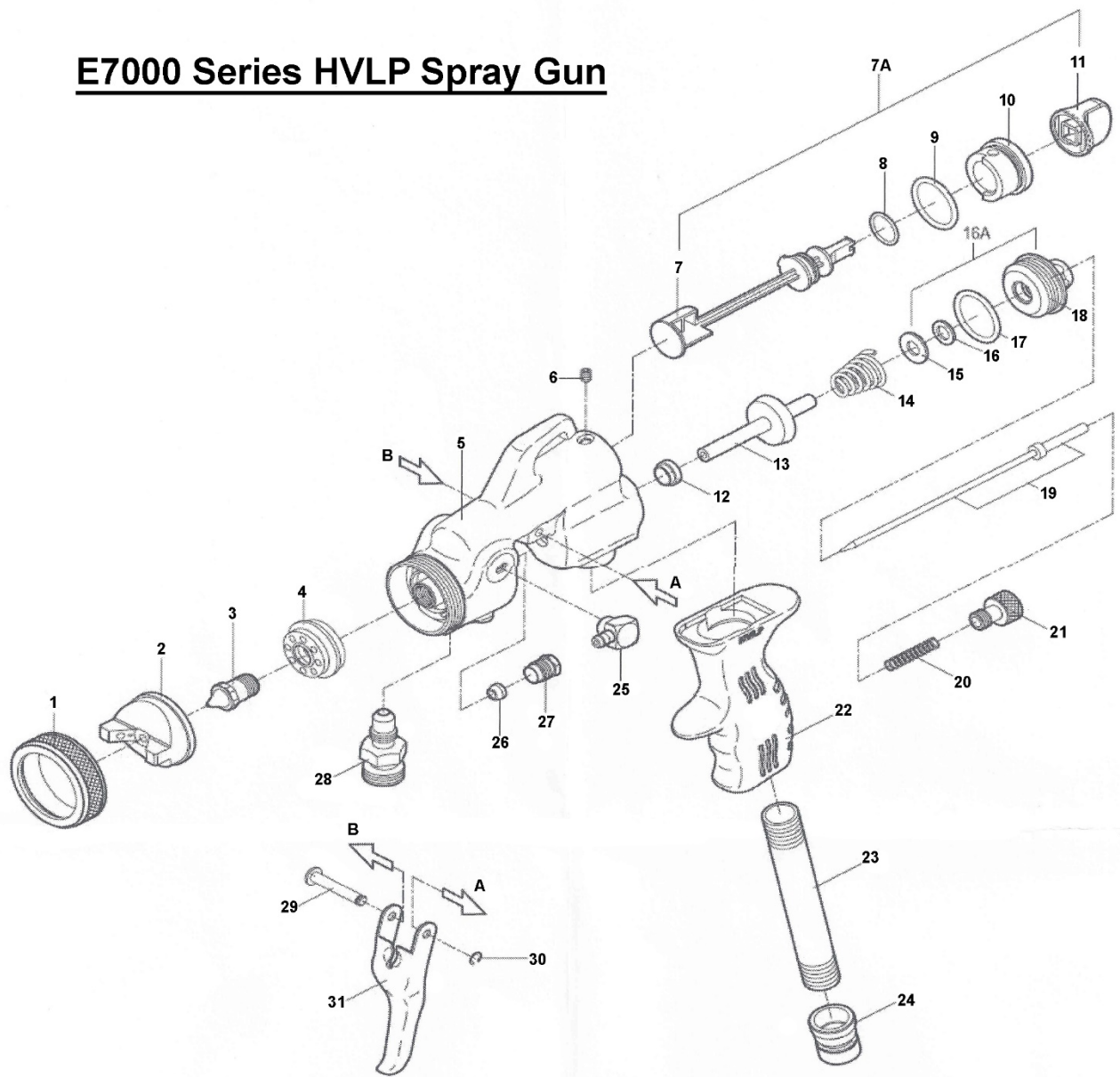

No.	Item #	Description	Qty.
1	E7001	Air Cap Ring	1
2	E7002	Air Cap	1
3	E7003	Fluid Nozzle	1
4	E7004	Air Distributor	1
5	E7005	Spray Gun Body	1
6	E7006	Fan Pattern retaining screw	1
7	E7007	Fan Pattern Adjustment Shaft	1
7A	E7007A	Fan Pattern Assembly Shaft complete with O-rings and knob	1
8	E7008	Fan Pattern Shaft O-ring (Small)	1
9	E7009	Fan Pattern Shaft O-ring (Large)	1
10	E7010	Fan Pattern Seat	1
11	E7011	Fan Pattern Adjustment Knob	1
12	E7012	Air Valve Bushing	1
13	E7013	Air Valve	1
14	E7014	Air Valve Return Spring	1
15	E7015	Air Valve Spring Seating Gasket	1

No.	Item #	Description	Qty.
16	E7016	Flow Screw Bushing Gasket	1
17	E7017	Flow Screw Bushing O-ring	1
18	E7018	Flow Screw Bushing	1
19	E7019	Needle Assembly	1
20	E7020	Needle Return Spring	1
21	E7021	Material Adjustment Screw	1
22	E7022	Handle	1
23	E7023	Handle Tube	1
24	E7024	Handle Coupler	1
25	E7025	Air Feed Connector (angle)	1
26	E7026	Gland Seal	1
27	E7027	Gland Seal Nut	1
28	E7028	Fluid Inlet Connector	1
29	E7029	Trigger Pivot	1
30	E7030	Trigger Pivot Clip	1
31	E7031	Trigger	1

# ***Apollo Sprayers International, Inc.***

## ***TWO Year Warranty***

The machine and equipment are WARRANTED by APOLLO SPRAYERS INTERNATIONAL, INC. for a total period of TWO YEARS from the ORIGINAL date of purchase by the ORIGINAL PURCHASER. Proof of purchase to be included and all SHIPPING CHARGES to be pre-paid.

**APOLLO SPRAYERS INTERNATIONAL, INC.** upon examination of the machine/equipment will **replace or repair** at their discretion any defects in material or workmanship.

Labor will be CHARGED at the current hourly rate, or specified Job Rate.

This WARRANTY does NOT include: miss-use, damage, neglect, alterations, disassembled equipment or modifications, lack of maintenance, cleaning, water damage to electrical parts and INCORRECT VOLTAGE CONNECTION. This WARRANTY is in lieu of all other express warranties, any WARRANTY implied by law, including but not limited to implied warranties of merchantability or fitness, is excluded to the maximum extent permitted by law and, if not excludable, it is limited to the duration of the express Warranty. No representative or person is authorized to extend this Warranty or to create for **APOLLO SPRAYERS INTERNATIONAL, INC.** any other liability in connection with the sale of any **APOLLO SPRAYERS product. APOLLO SPRAYERS INTERNATIONAL, INC.** shall not be liable for any consequential, incidental, or special damages of any kind directly or indirectly resulting from breach of any express or implied Warranty. Some States do allow the exclusion of limitation of incidental or consequential damages or limitations on the length of any Warranty so that the above limitations and exclusions may not apply to you; however, to the maximum extent permitted under applicable law, the only rights and remedies shall be to obtain a replacement for any defective product. This Warranty gives you specific legal rights and you may also have other rights which vary from State to State.

For warranty repairs inside the United States please call 888-900-4857 or outside the United States call, 760-727- 8300. All repairs must be accompanied by an RMA number from the factory. Please call first before sending any equipment back to the factory for repair. Any equipment returned without a proper RMA number will be refused.

**Apollo Sprayers International, Inc.**  
**1030 Joshua Way, Vista, CA 92081**  
**Customer Service: (760) 727-6226**  
**Fax: (760) 727-9325**  
**Toll Free Sales: (888) 900-HVLP (4857)**  
[www.hvlp.com](http://www.hvlp.com)

 **WARNING:** This product can expose you to chemicals including Chromium, which is known to the State of California to cause cancer and birth defects or other reproductive harm. For more information go to [www.P65Warnings.ca.gov](http://www.P65Warnings.ca.gov).