

Apollo Sprayers **HVLP**

Instruction Manual
7700 Series



Apollo Sprayers International, Inc.
1030 Joshua Way
Vista, CA 92081
760-727-8300
www.hvlp.com

1. Safety	3
2. Introduction	4
2.1 About Your New Spray Gun	4
2.2 The 7700 Atomizer® & Turbine Systems	4
2.3 O.S. – Overspray Control/Texturing Feature	5
2.4 The 7700 Atomizer® As A Bleeder Type Spray Gun	5
3. Setup	6
3.1 Installing Air Relief Mechanism (Turbine Systems Only)	6
3.2 Installing And Using The O.S. (Overspray) Control	7
3.3 Cup Assemblies And Turbine Air	7
3.4 Installing A One Quart Cup Assembly (For Use With Turbine Air)	9
3.4.1 Installing A One Quart Cup Assembly (Turbine Air)	10
3.5 Assembly Of Your Pressure Pot System	12
3.6 The 7700 Atomizer® & Compressed Air	13
3.7 Preparation Of 7700 Atomizer® For Production Spraying	19
3.8 Installing Cup Air Regulator And Gauge (Compressor Only)	20
3.9 Using Your 7700 Atomizer® With An Optional Handle Air Regulator	20
4. Operation	21
4.1 Spray Patterns	21
4.2 Spray Gun Technique	22
4.3 Using The 7700 Atomizer® With A Turbine System	23
4.4 Using The 7700 Atomizer® With Compressed Air	23
4.5 Selecting Nozzles, Needles And Air Caps	24
4.6 Understanding Your Viscosity Meter	25
4.7 Know Your Coating Properties	25
4.8 Apollo HVLP Turbine Properties	26
4.9 Cleaning Your 7700 Atomizer® Spray Gun	26
5. Record Of Spray Gun Use	31
6. Record Of Spray Gun Maintenance	31
7. Troubleshooting	32
8. Diagram & Parts List	33
9. Warranty	38

1. Safety

Read all instructions and safety precautions before operation.

▲ DANGER

Indicates a hazardous situation, which, if not avoided, will result in death or serious injury.

▲ WARNING

Indicates a hazardous situation, which, if not avoided, could result in death or serious injury.

▲ CAUTION

Indicates a hazardous situation, which, if not avoided, could result in minor or moderate injury.

NOTICE

Indicates a situation that could result in damage to the equipment or other property.

▲ WARNING

- Risk of fire or explosion! Solvent and paint fumes can explode or ignite, causing severe injury and property damage.
- Paints and solvents containing HALOGENATED HYDROCARBONS can react explosively with aluminum. Always check the product's label before using these materials in the unit.
- Hazardous vapors: Paint, solvents, insecticides and other materials may be harmful if inhaled, causing severe nausea, fainting or poisoning.
- Make sure the room is well ventilated. Avoid all ignition sources, such as static electricity, sparks, open flames, hot objects, sparks from connecting and disconnecting power cords, and working light switches.
- Follow the material and solvent manufacturers' safety precautions and warnings. Do not use liquids with flash points less than 100° F (38° C).
- Static electricity can be produced by HVLP spraying. Make sure any electrically conductive object being sprayed is grounded to prevent static sparking. The sprayer is grounded through the electrical cord to prevent static sparking.
- Use a respirator or mask whenever there is a chance that vapors may be inhaled. Read all instructions with the mask to ensure that the mask will provide the necessary protection against the inhalation of harmful vapors.



NOTICE

Tipping the spray gun causes the spray gun to clog. Dried spray material also clogs the pressure delivery tube and fittings. The spray gun does not function when clogging occurs.

2. Introduction

You are about to experience a unique, superb performing TrueHVLP™ spray gun. The Apollo 7700 Atomizer® offers the most modern and advanced HVLP technology available today. Special features are our new Xpansive™ Fan Control, and MicroTech™ Atomization Technology. Please take a few minutes to read about these features so that you can experience the ease and benefits of TrueHVLP™ spray finishing. The Apollo 7700 Atomizer® spray gun comes pre-tested and packaged in a custom spray gun case for proper storage and protection.

You should have the following items in the case:

- A 7700 Atomizer® spray gun with 1.0mm nozzle and needle paired with a “B” Air Cap (Gold) installed.
- Wrench (Spanner)
- Cleaning Brush
- Air Feed Connector
- Non-return valve
- 1 x 1 quart (1 liter) cup top gasket OR 1 x 250cc/600cc/1000cc (dependent on the cup size) cup top gasket OR 1 x 8 ounce cup top gasket
- Sample bottle – spray gun lube
- Instruction manual



2.1 About Your New Spray Gun

The Apollo 7700 Atomizer HVLP spray gun is a multi-use, multi-purpose HVLP spray gun. The 7700 Atomizer will operate on most professional HVLP turbine systems or as a TrueHVLP™ spray gun on any air compressor (3hp – 20 gal [75 liter] tank or larger). The 7700 Atomizer is designed to operate as a production spray gun from a fluid feed system, a bottom mounted cup gun or as a top mounted cup gun.

2.2 The 7700 Atomizer® & Turbine Systems

The 7700 Atomizer is a standard turbine spray gun – non-bleed type. When the turbine is turned on, NO air will flow through the spray gun. When the trigger is partially pulled, air will flow through the air cap. When the trigger is fully pulled, paint will flow through the nozzle (tip) to meet the air flow, atomize and project to your work surface. ***It is most important that your turbine system be equipped with a proper internal air relief valve to handle the back pressure when the trigger is released and the turbine is running.***

All Apollo models manufactured after 2007 which includes; 725, 825, 835, 835VR, 1025, 1035, 1040VR, 1050, 1050VR, Power-3, Power-4, Power-5, Precision-5 and Precision-6 are equipped with an internal air relief valve. All other Apollo models manufactured prior to 2007 and not previously listed will require an external relief valve that must be attached to the air outlet on the turbine before using the 7700 Atomizer spray gun. Failure to install part number A7538A when using the 7700 Atomizer spray gun with older turbine systems can cause premature failure of the turbine motor due to excessive back pressure and will void your warranty.

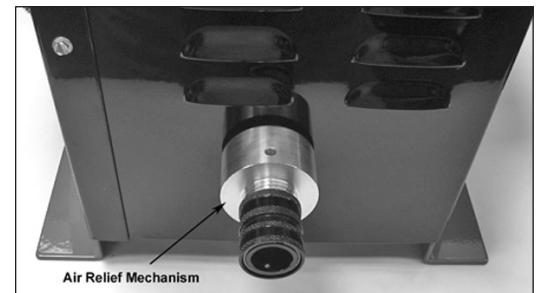

If you are using the Apollo 7700 Atomizer spray gun with a turbine system other than one manufactured by APOLLO, it is advised to inquire with the turbine manufacturer to determine if your unit is configured to accept a non-bleed spray gun. If you are not sure, or if you cannot get accurate information it is strongly advised that you install Apollo part number A7538A prior to using the 7700 Atomizer spray gun.

2.3 O.S. – Overspray Control/Texturing Feature

The O.S. control will permit the safe reduction of air flow and air pressure from the turbine, when necessary. The O.S. control should be used if an extremely thin coating or low viscosity product is being sprayed and you desire to reduce atomizing pressure to achieve maximum efficiency and the least amount of overspray for your turbine unit. The O.S. control can also be used to create a textured or splatter effect with selected coatings.

NOTE: O.S. Control is not needed when using an 835VR, 1050VR, Power-VS or Precision 5 variable speed turbine system.

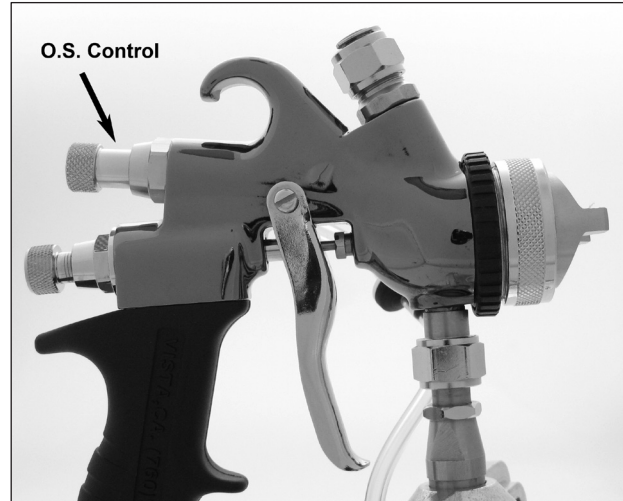

2.4 The 7700 Atomizer® As A Bleeder Type Spray Gun

With the appropriate optional adapter, the 7700 Atomizer can be operated as a bleeder type spray gun. You will need to add an upper port air hose coupler (#13C, page 33) to the port above the material adjusting screw (#20, page 33). Make sure you also blank the bottom of the handle with part (#29, page 33). This arrangement will bypass the non-bleeder valve assembly and allow you to operate your 7700T spray gun as a "bleeder" style gun.

Sometimes it's not convenient to have the hose connected to the bottom of the handle. This option also allows you to hold the hose in a different position, by connecting your air hose to the top of the spray head and running the hose over your shoulder. This is especially nice when spraying, hoods on cars, tables, or inside bathtubs.

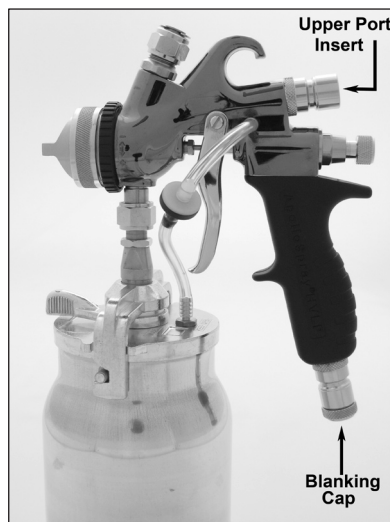

3. Setup

3.1 Installing Air Relief Mechanism (Turbine Systems Only)

As previously noted, Apollo Models 725, 825, 835, 835VR, 1025, 1035, 1040VR, 1050, 1050VR, Power Series and Precision Series have an air relief mechanism internally installed and **DO NOT** require an external air relief mechanism. All other Apollo Models require the installation of Apollo Part #A7538A to the turbine air outlet prior to operating The Atomizer 7700 spray gun.

The air relief mechanism Part #A7538A must also be installed on ANY MAKE turbine system that does not have an air relief mechanism installed. If using with a system other than Apollo, please check with the manufacturer to determine if a non-bleed spray gun can be safely operated on your system. If not, install Part #A7538A before operating the 7700 Atomizer spray gun.



A7538

To install Part #A7538A Air Relief Mechanism, first locate and remove the Air Hose Quick Connect.

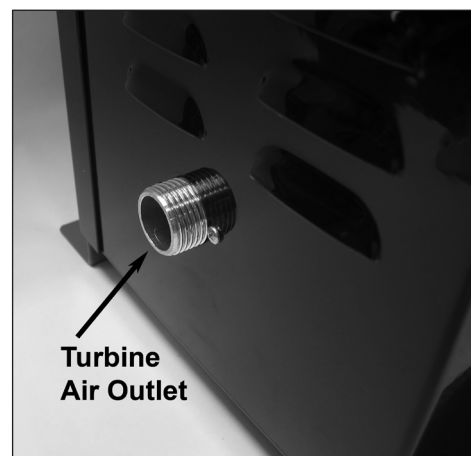

Second, screw the air relief mechanism onto the turbine air outlet. Third, screw the Air Hose Quick Connect onto the Air Relief Mechanism. Make sure to install the Air Relief Mechanism with the bleed hole pointing upwards. Failure to do so, will blow dust and dirt around on the floor while you are spraying.

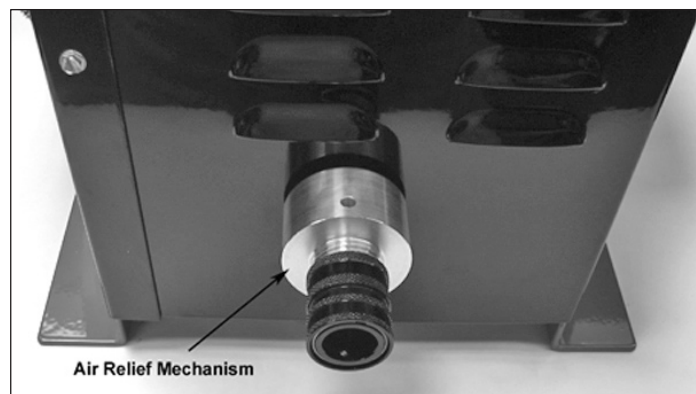
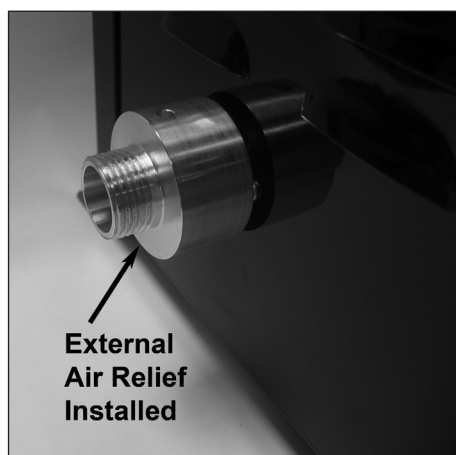

3.2 Using The O.S. (Overspray) Control

Keep the O.S. control in the full open position when not in use. Rotate the O.S. Control air flow screw counterclockwise (anti-clockwise) until it stops, this is its full open position.

To operate, turn the air flow control screw clockwise at least 2/3 of the way in. Test spray to see if the reduced flow of air reduces overspray/pressure to your desire. If not, continue to rotate the air flow control screw until the desired results are achieved. Be sure that you still have enough pressure to atomize your coating to provide a good quality finish. If not, increase the air flow by turning the screw counterclockwise until you feel you have the most efficient results.

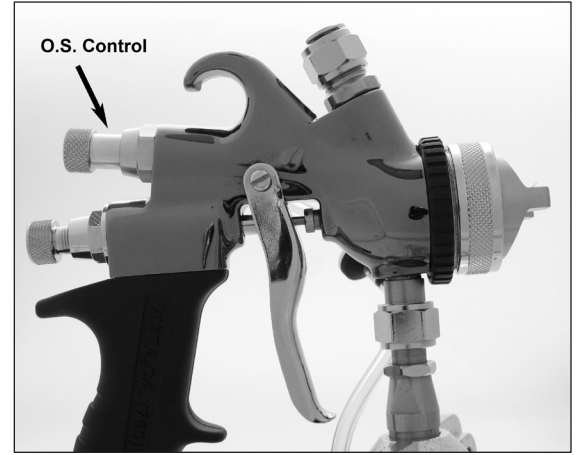

To create a textured or splattered paint effect, turn the air control screw all the way closed (clockwise). Do not thin your paint, or if you have to, thin it very slightly to permit it to flow. Hold the spray gun further back from the work piece than you normally would for regular finish spraying, at least 8" or more. You should now have a splatter effect. Adjust paint viscosity accordingly to produce desired particle size.

In order to properly protect your turbine, you cannot completely shut off the air flow with the OS Control.

If you still feel that you are experiencing overspray, please refer to your instruction manual or to our website FAQ pages for additional information.

3.3 Cup Assemblies and Turbine Air

A variety of cup assemblies are available for the 7700 Atomizer.

You can install a standard 1 quart (1 liter) cup assembly to the 7700 Atomizer spray gun.



An 8oz. (250cc) mini-cup assembly can be installed on the 7700 Atomizer spray gun when smaller quantities of material are to be sprayed or when a smaller cup assembly is desired.



A 3oz (88cc) super-mini cup assembly can be installed on the 7700 for even smaller quantities of material or for compliance with local regulations.



A top mounted gravity cup can also be used. Apollo offers a 250cc, 600cc and 1000cc top mounted cup.



250cc Cup



600cc Cup



1000cc Cup

The 7700 Atomizer can also be used as a production spray gun in conjunction with any size pressure pot. Apollo offers a 2 quart (2 liter), a 2.5 gallon (10 liter), and 10 gallon (37 liter) pressure pot (not shown).

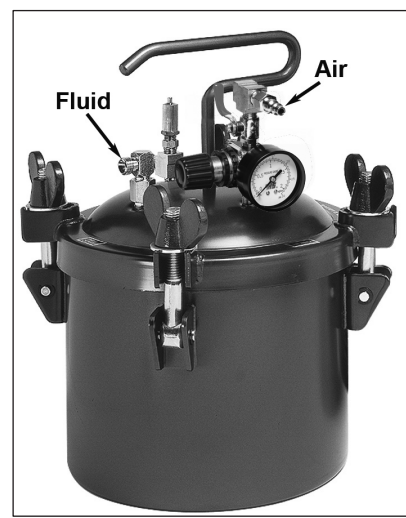
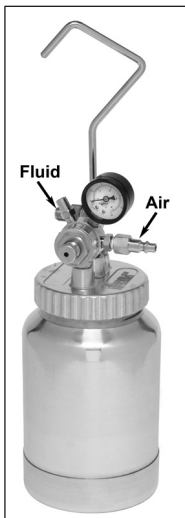

3.4 Installing A One Quart Cup Assembly (For Use With Turbine Air)

To install a standard 1 quart (1 liter) cup assembly to the 7700 Atomizer turbine spray gun follow these simple instructions:

1. Be sure there is a material blanking cap (#12, page 33) installed in the upper port material connection.



2. Screw the cups center bolt to the material connector, finger tight.



3. Locate the brass air feed nipple on the cup top and rotate the cup lid so that the brass nipple is in the 7 o'clock position and the cup lever is in the front of the gun.

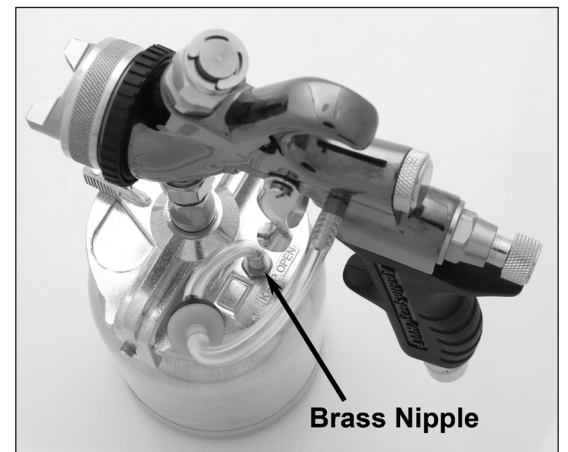

4. While holding the cup assembly firmly, tighten the cups center bolt with the wrench (spanner) supplied.



5. Remove the stainless steel screw located on the side of the spray gun and replace it with the air feed connector (#23, page 33) located in the plastic bag inside your spray gun box.



6. Join the air hose to the spray gun from the cup. Connect one end of the air hose to the air feed connector (#23, page 33), and the other end to the brass nipple in the top of the cup lid. Be sure that the black half of the valve is facing toward the cup.



3.4.1 Installing A Mini Cup Assembly

An 8oz. (250cc) or 3oz. (88cc) cup assembly can also be installed on the material connector when smaller quantities of material are to be sprayed or when a smaller cup assembly is desired.



To install the 8oz. (250cc) or 3oz. (88cc) cup assembly, first install the material adapter, A4150. Locate the material connector and screw the material adapter on. Follow the installation instructions for the 1 quart (1 liter) cup assembly.

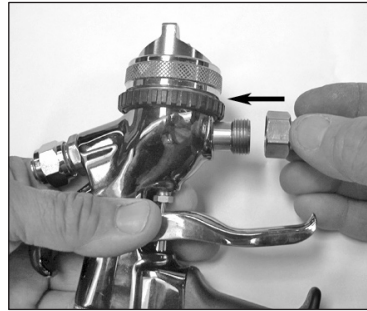
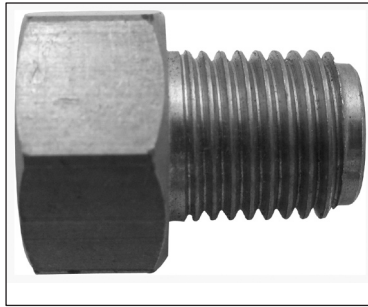

3.4.2 Installing A Gravity Fed Cup Assembly (Turbine Air Only).

1. Locate the cap (#12, page 33) that blanks the unused material connection and make sure that it is installed onto the bottom material connection.
2. Screw the top feed cup to the top material connection and tighten with the wrench (spanner). You are now ready to spray.

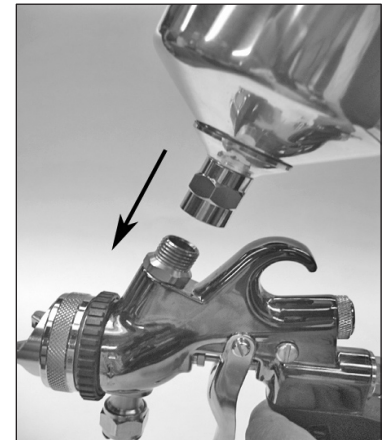
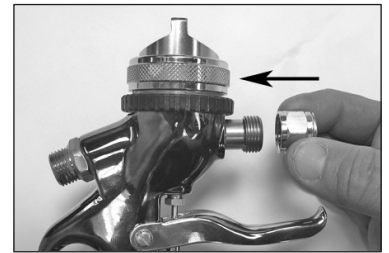

3. Sometimes when spraying heavy materials cup pressure is required. If cup pressure is required, remove the stainless steel screw located in the side of the spray gun and replace it with the air feed connector (#23, page 33). This is where your air hose joins the spray gun from the cup.



4. Connect one end of the air hose to the air feed connector (#23, page 33) and the other end to the brass nipple in the top of the cup lid. Be sure that the black half of the valve is facing toward the cup.

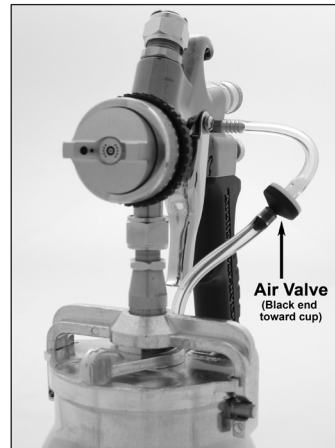
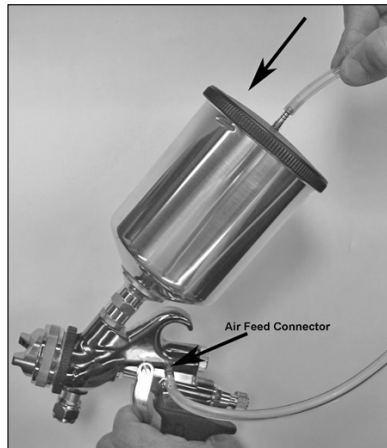

3.5 Assembly Of Your Pressure Pot System

There are many advantages to using pressure pots with a turbine system. Apollo Sprayers have made this very easy with our fluid feed systems, 4500 and 4550. By removing the paint cup from the spray gun you immediately reduce the overall weight of the spray gun by approximately 50%. You also get a smaller tool to hold in your hand thereby allowing you to more easily access the back of cabinets or other tight spaces where a standard cup gun would not fit. By using a pressure pot you are able to spray larger quantities of material without stopping to refill a smaller cup. This can save a lot of time on a long job where you are spraying the same material all the time.

Using a pressure pot with any size turbine system is very easy. All you need is any size pressure pot, a fluid hose and a small air compressor. When using a remote cup or pressure pot, it is necessary to introduce compressed air in order to pressurize the remote pot and move the fluid from the pot to the spray gun tip/nozzle. In general 5PSI (0.345 Bar) of air pressure is adequate to push most average viscosity fluids to the spray gun nozzle. Higher pressure would only be necessary for heavier viscosity fluids or if you are spraying up a ladder where the fluid has to travel more than 6 feet in elevation. To set up your 7700 Atomizer for use with a pressure pot, follow these instructions:

1. Connect the black fluid hose to the fluid outlet on the top of the pressure pot. Refer to your pressure pot instructions for the specific location of the fluid outlet.
2. Seal the threads with Teflon tape and tighten with a wrench (spanner) to assure no fluid leaks once you pressurize the pot.
3. Connect the air line from your compressor to the air inlet on the pressure pot. This should be a male quick connect adjacent to the regulator and gauge. If your quick connect is the same style as the one on the pot you can pull back the ring on the female end and insert into the male end, releasing the ring to fasten them together.
4. Connect the other end of the black fluid line to the material connector on the spray gun.

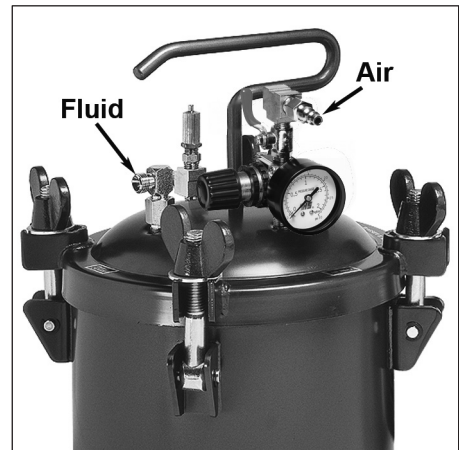
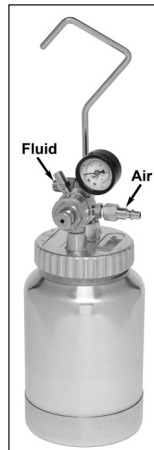
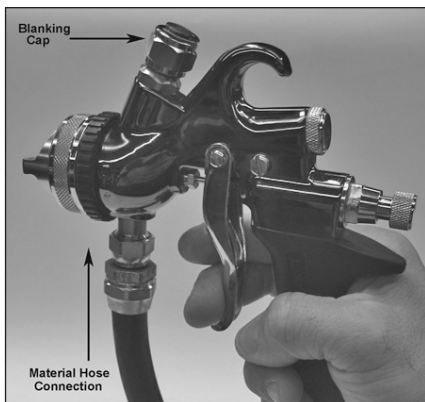

NOTE: Make sure that the top material connector has been capped with the material blanking cap (#12, page 33).

NOTICE

Do not attempt to remove material connectors in either the upper or bottom ports. This may cause your spray gun to leak internally.

5. Connect your turbine air hose as normal.

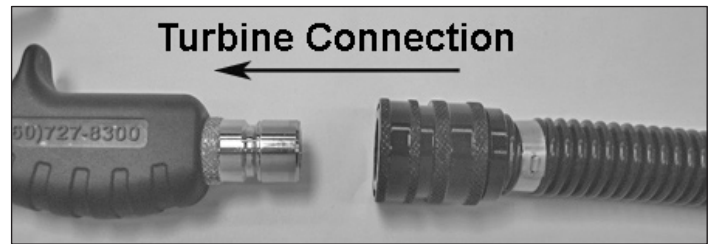

3.6 The 7700 AtomiZer® & Compressed Air

The 7700 AtomiZer spray gun can easily become a TrueHVLP™ compressed air spray gun (conversion gun) by unscrewing the male Turbine quick connect coupler (#28, page 33) and replacing it with the compressed air handle coupler or screwing a standard male compressed air fitting directly into the turbine handle coupler.



3.6.1 Installing A Cup Assembly (Compressed Air)

To install a standard 1 quart (1 liter) cup assembly to the spray gun follow these simple instructions:

1. Locate the cap (#12, page 33) that blanks the material connector not being used and make sure that it is installed on the top material connection.

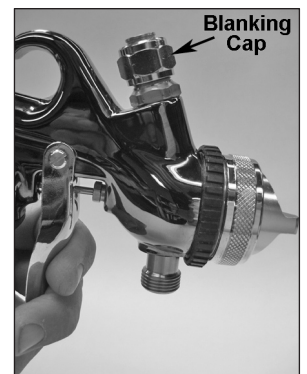

2. Screw the cups center bolt to the material connector, finger tight.



3. Locate the brass air feed nipple on the cup top and rotate the cup lid so that the brass nipple is in the 7 o'clock position.

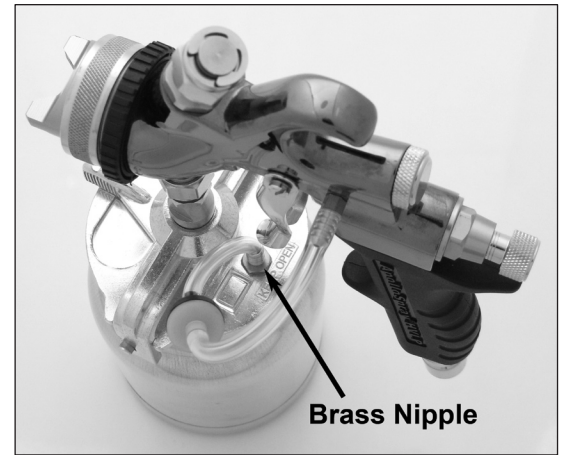

4. While holding the cup assembly firmly, tighten the cups center bolt with the wrench (spanner) supplied.



5. Remove the stainless steel screw located in the side of the spray gun and replace it with the air feed connector (#23, page 33).

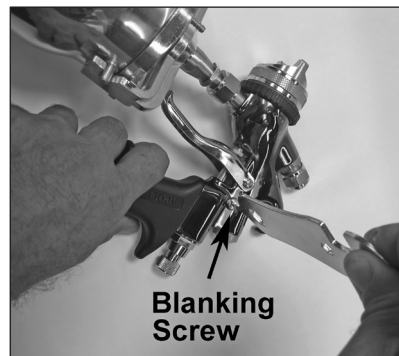

- Join the air hose to the spray gun from the cup. Connect one end of the air hose to the air feed connector (#23, page 33), and the other end to the brass nipple in the top of the cup lid. Be sure that the black half of the valve is facing toward the cup.



3.6.2 Installing A Mini Cup Assembly (Compressed Air)

An 8oz. (250cc) or 3oz. (88cc) cup assembly can also be installed on the material connector when smaller quantities of material are to be sprayed or when a smaller cup assembly is desired.



- To install the 8oz. (250cc) or 3oz. (88cc) cup assembly first install the material adapter, A4150. Locate the material connector and screw the material adapter on, make sure you seal the threads with Teflon tape or other thread sealer. Follow the installation instructions for the 1 quart (1 liter) cup assembly.

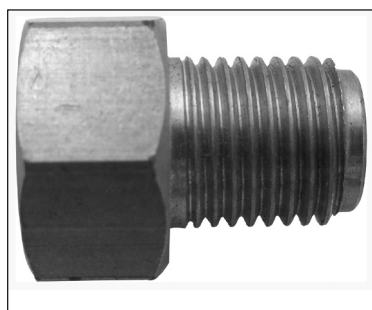

3.6.3 Installing a Gravity Fed Cup Assembly (Compressed Air Only)

1. Locate the cap (#12, page 33) that blanks the unused material connection and make sure that it is installed onto the bottom material connection.

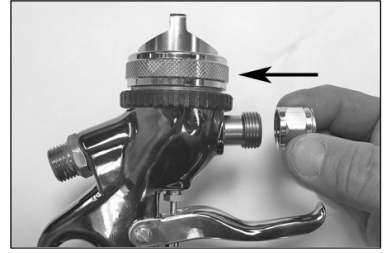

2. Screw the top feed cup to the top material connection. You are now ready to spray.

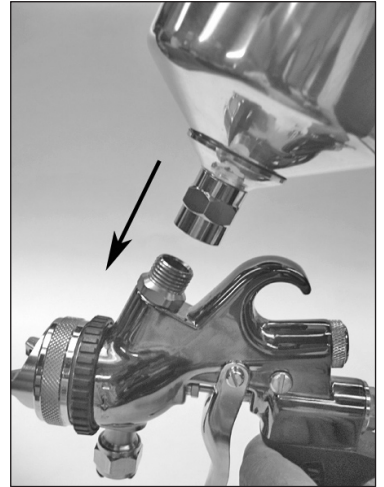

3. Sometimes when spraying heavy materials cup pressure is required. Attach the cup air pressure regulator to the bottom of the spray gun handle.



4. Connect one end of the air hose to the cup air pressure regulator.
5. Connect the other end of the air hose to the brass nipple in the top of the cup lid. Be sure that the black half of the valve is facing toward the cup.



3.6.4 Using Your 7700 AtomiZer With A Pressure Pot

Using a pressure pot with your 7700 AtomiZer spray gun is very easy. All you need is any size pressure pot, a fluid hose, a 3/8" diameter air hose and any air compressor 3hp with a 20 gal (75 liter) air tank or larger. We recommend a pressure pot with two regulators. One to regulate air pressure to the spray gun and a second to regulate air pressure to the pressure pot.

The basic 7700C AtomiZer spray gun is ready to set up for production use with your pressure pot.

If you are converting your 7700 AtomiZer from a cup gun to production, follow these steps first. If not, skip to step one of Section 3.7 for preparation:

1. Disconnect the air feed tube from the side of the spray gun.
2. Remove the air feed connector (#23, page 33) and reinstall the blanking screw.



3. If you were using a gravity cup, move the blanking cap from the bottom connector to the top.

NOTE: Make sure that the top material connector has been capped with the material blanking cap (#12, page 33).



NOTICE:

Do not attempt to remove material connectors in either the upper or bottom ports. This may cause your spray gun to leak internally.

3.7 Preparation Of 7700 AtomiZer For Production Spraying

1. Apply a thread sealer or Teflon tape around the threads of the fluid connector (#29, page 33) on the spray gun.
2. Connect fluid hose to the fluid connector on the spray gun. Tighten firmly with a wrench (spanner).
3. Connect 3/8" air hose to handle coupler of the 7700 AtomiZer spray gun using a quick connect coupler.
4. Connect the fluid hose to the fluid outlet on the top of the pressure pot. Refer to your pressure pot instructions for the specific location of the fluid outlet. Seal the threads with thread sealer or Teflon tape and tighten with a wrench (spanner) to assure no fluid leaks once you pressurize the pot.

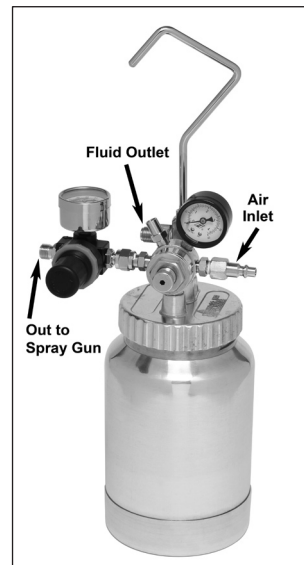

2.5 gallon (10 litre) deluxe pressure pot. 2 quart (2 litre) pressure pot.

5. Connect the 3/8" air line to the regulator air outlet on the pressure pot.
6. Connect the air line from your compressor to the air inlet on the pressure pot. This should be a male quick connect adjacent to the regulator and gauge. If your quick connect is the same style as the one on the pot you can pull back the ring on the female end and insert into the male end, releasing the ring to fasten them together.

It is necessary to test the air pressure in the pressure pot to make sure that it is appropriate for the viscosity of material being sprayed and the situation in which it is being sprayed. You don't want the material coming out too quickly so that you get runs and sags, but you also don't want it to come out too slowly so that you are spraying very slowly. To test the air pressure in the pressure pot follow these simple instructions:

1. **DO NOT** turn on the regulator to the spray gun.
2. Make sure your air hose and material hose are connected appropriately to the pressure pot.
3. Turn on your air compressor and wait until you have about 5PSI (0.345 Bar) in the pressure pot. Then, pull the trigger on the spray gun until a stream of fluid flows from the tip/nozzle. NOTE: This may take a few minutes depending on the length of your fluid hose.
4. Adjust the pressure on the pot regulator until the fluid drops off or bends at approximately 2-1/2 " (6.35cm).
5. Your pot air pressure should be correct at this point, however, if the stream bends too short then increase the air pressure. If the stream bends too far, then reduce the air pressure. If you need additional help, please feel free to call our technicians at 1-888-900-4857.

CAUTION

Depressurize pressure pot using safety valve when equipment will be idle for a while. This will prevent excess fluid from remaining in fluid hose, and prevent a possible accident if the trigger is pulled causing material to stream from the spray gun.

Always ensure that the remote pot is tightly sealed, and all gaskets are in good shape, to prevent air and fluid leaks. Be sure to flush and clean the fluid hose at the end of a work session. For smaller jobs, insert a one gallon can inside a 2.5 gallon (10 litre) pressure pot. This will help to keep the inside of the pot cleaner and reduce the time necessary for cleaning up when you are finished.

3.8 Installing Cup Air Regulator And Gauge (Compressor Only)

(Optional item)—Recommended when using gravity cup with pressure. When using The 7700 AtomiZer® with compressed air and a pressurized gravity cup, it is necessary to regulate the pressure to the cup to ensure proper delivery of material to the spray nozzle (approximately 3psi – 5psi). Failure to install the air regulator can result in leakage around the cup seal, and/or poor finish quality. No regulator is necessary when using The 7700 AtomiZer® as a production spray gun from a pressure pot system or other styles of cup assemblies.

1. Install the compressed air handle coupler onto the bottom of the handle.



2. Thread the regulator onto the handle coupler so that the gauge is located to the right of the spray gun.

3. Once your gravity cup of choice is installed connect the air feed tube from the brass nipple on the regulator to the brass nipple on the cup lid.

4. Be sure that the black half of the valve is facing toward the cup.



3.9 Using Your 7700 AtomiZer® With An Optional Handle Air Regulator.

Your 7700 AtomiZer® spray gun can be used with a regulator attached at the bottom of the handle. This will allow you to adjust your air pressure from the spray gun, rather than your wall regulator or compressor.

To install the handle air regulator follow these instructions:

1. Locate the compressed air handle coupler.

2. Attach regulator as shown in picture.

3. Attach quick connect coupler to regulator.

4. Attach air hose to quick connect coupler and adjust air pressure as needed.

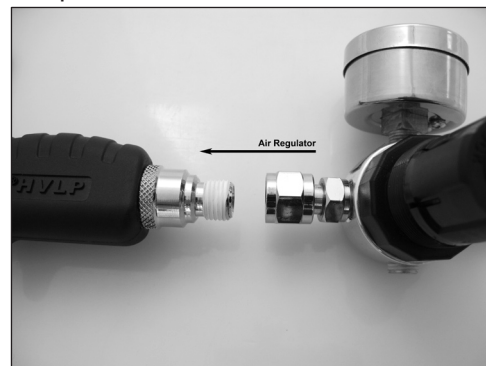

4. Operation

The Apollo 7700 Atomizer has a unique and simple fan pattern control. Locate the Fan Adjustment Ring. Turn the spray gun on its side and notice the fan size indicator stamped into the spray head casting, just to the right of the fan adjustment ring. You will notice that there is a “-” sign at the top and a “+” sign at the bottom with two arrows indicating the direction of rotation. Rotating the ring UPWARD will begin to reduce the size of the fan pattern until the pattern is round. Rotating the ring DOWNWARD will provide a full, open, wide pattern. (Relative to the distance the spray gun is held from the work surface). To adjust the direction of the fan pattern, loosen the air cap ring, (#1, page 33) rotate the air cap ears (#3, page 33) to either a vertical or horizontal position as noted in the diagram. This will provide your vertical or horizontal fan pattern.

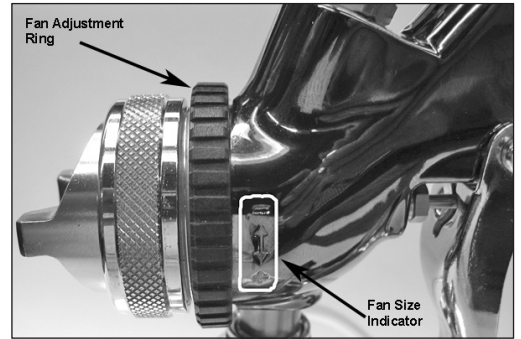

4.1 Spray Patterns

Fig. 1 Use this position when spraying across from side to side.

Fig. 2 Use this position when spraying from top to bottom.

Fig. 3 Use this position for spotting small objects, corners and sharp angles.

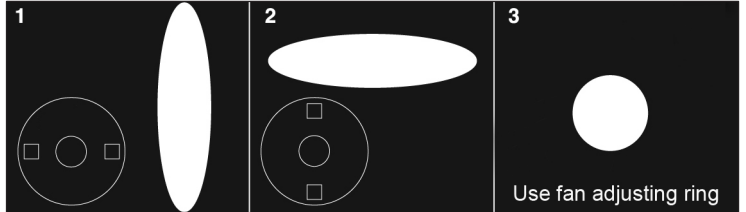

Install the appropriate fluid nozzle, needle assembly and color coded air cap (A, B, C or D) for the viscosity of the fluid being sprayed. See chart for recommendations (Section 4.5). Your spray gun is supplied with a 1.0mm Fluid Nozzle and Needle Assembly paired with a “B” (Gold) air cap. Prepare coating. (Thinning if necessary). Filter and pour into spray gun. See chart.

Viscosity Chart Guideline		
Coating	Thin/Reduce	Viscosity in Seconds
Lacquers	25% - 50%	15-22 seconds
Sanding Sealer	20% - 30%	15-22 seconds
Enamels	20% - 40%	16-22 seconds
Stains	use from can	15 seconds
Acrylic Enamel	50% - 60%	15-17 seconds
Catalyzed Polyurethane	10% - 30%	15-18 seconds
Varnishes	20% - 30%	16-22 seconds
Waterbase Coatings	00% - 10%	24-34 seconds

Viscosity chart should be used as a guide to thinning various coatings. Actual reduction will depend upon model turbine used, flow out properties of the coating and the final visual results of the sprayed work piece. Seconds quoted are measured in a Zahn #2 Viscosity Cup.

Zahn Cup sec (#2)	Zahn Cup sec (#4)	Ford cup sec (#3)	Ford cup sec (#4)	Poise P	Centi-poise cP	Krebs KU	Saybolt SSU
16			5	0.1	10		60
17			8		15		80
18		12	10	0.2	20		100
19		15	12		25		130
20		19	15	0.3	30		150
22		25	17	0.4	40		210
24		29	19	0.5	50	30	250
27		33	21	0.6	60	33	320
30		36	23	0.7	70	35	370
34		41	26	0.8	80	37	430
37		45	29	0.9	90	38	480
41	10	50	31	1	100	40	530
49	11	58	36	1.2	120	43	580
53	13	66	41	1.4	140	46	690
56	14	67	45	1.6	160	48	790
74	16		51	1.8	180	50	900

Connect the appropriate air hose to the spray gun. Begin turning the material flow screw (#20, page 33) anti or counter clockwise 1 – 2 full turns. Look at the size of the fluid pattern and flow volume. Adjust before applying material to your substrate. If you have too much fluid flow turn the material flow screw clockwise. If you do not have enough fluid flow, adjust the material flow screw anti/counter clockwise. Hold spray gun 4” – 8” (10cm-20cm) from your work surface depending on the size of your substrate. Closer is generally preferred for highest efficiency and the least amount of overspray. Follow the proper spray technique as outlined in the spray technique diagram. You can increase or decrease the fluid flow as desired as well as the distance from your work surface as necessary. Adjust the Fan Pattern Control Ring as desired.

4.2 Spray Gun Technique

Like any skill, practice makes perfect. Never try to rush the spray finishing process. Learn the characteristics of the coating you will be spraying. Build up layers of material (3–4 applications or more if necessary). Sand between coats and allow proper drying time between applications. It is important to remember to always keep the distance of the spray gun the same when moving across your work (or up and down). (Called a “pass”). Do not rotate or turn your wrist from side to side. Move the spray gun across your work from end to end.

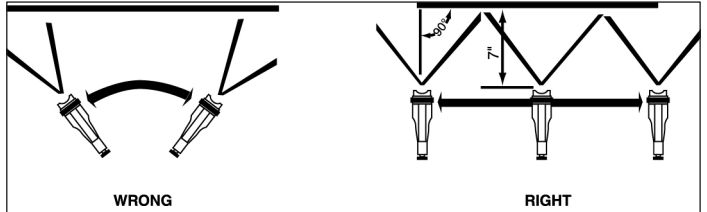

Be sure to maintain the same speed of movement. This will ensure an even application of coating. Always release the trigger at the end of a “pass”. Continue spraying in the opposite direction overlapping your previous coat by 1/3rd to 1/2. When finished you should have an even wet coat on your work. If you have dry spots you have overlapped too wide. If you have heavy or wet spots, or runs you have overlapped too much. When spraying a large or preassembled piece, start at the top and work down. Try to spray the hard to reach and underneath surfaces first. Common sense and some forethought will prevent errors.

Remember, that a light wet film will generally produce better results than a heavy wet coat. When spraying a vertical surface it is advisable to spray a thin/light “tack” coat first, followed by a normal light wet coat. This technique will help prevent “runs” and “sags”. When using your APOLLO spray gun you control five variables:

1. Fluid Flow
2. Distance of the spray gun from your substrate (4”-8” avg., closer if necessary).
3. Pattern Direction (Vertical, Horizontal & Round fan)
4. Speed of application
5. Fan Pattern Size (adjust fan control ring)

Items 1, 2 & 4 directly relate to each other.

4.3 Using The 7700 Atomizer® With A Turbine System

After set up of spray gun is complete:

1. Connect the air hose to the male air quick connect located at the bottom of the spray gun handle.
2. Connect the other end of the air hose to your Turbine.
3. Turn on your turbine. Make sure air is always coming out of the air relief mechanism. (If external).
4. You are ready to spray and apply coating to your work, follow general spraying instructions.

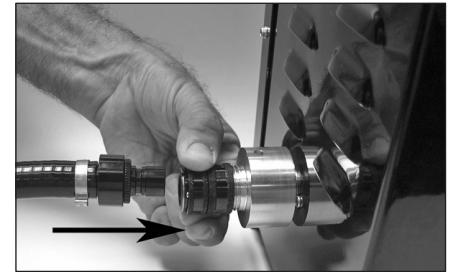
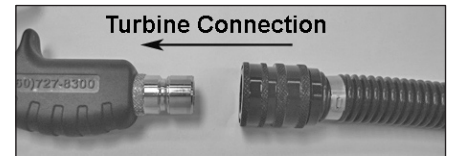

4.4 Using The 7700 Atomizer® With Compressed Air

Be sure air lines are clean, moisture and oil free. Drain any in-line filters. Be sure the compressor you are using will maintain continuous air (flow pressure) to continuously supply the spray gun. Generally a 3hp air compressor with a 20 gallon (75 liter) tank will maintain continuous air at 13PSI - 19PSI (0.9 Bar - 1.31 Bar). A larger compressor might be necessary if spraying high viscosity materials at higher PSI. Set the regulator to the spray gun as follows: 6 PSI - 12 PSI (0.414 Bar - 0.83 Bar) for thin, low viscosity fluids. 13PSI - 23PSI (0.9 Bar - 1.59 Bar) for medium to high viscosity fluids.

Without Air Regulator

7700C Pressure Settings - Std. Air Cap	
Inlet	Air Cap
22PSI	10PSI
20PSI	9PSI
19PSI	8PSI
17PSI	7PSI
15PSI	6PSI
13PSI	5PSI
10PSI	4PSI
8PSI	3PSI
5PSI	2PSI

Chart shown with Standard Air Cap, Turbine coupler and high flow fittings.

Without Air Regulator

7700C Pressure Settings - HS Air Cap	
Inlet	Air Cap
22PSI	10PSI
20PSI	9PSI
19PSI	8PSI
17PSI	7PSI
15PSI	6PSI
13PSI	5PSI
11PSI	4PSI
9PSI	3PSI
6PSI	2PSI

Chart shown with High Solids Air Cap, Turbine coupler and high flow fittings.

With Air Regulator

7700C Pressure Settings - Std. Air Cap	
Inlet	Air Cap
23PSI	10PSI
21PSI	9PSI
18PSI	8PSI
16PSI	7PSI
14PSI	6PSI
12PSI	5PSI
9PSI	4PSI
7PSI	3PSI
4PSI	2PSI

Chart shown with Standard Air Cap, Turbine coupler with 1/4" x 1/4" adapter and regulator - no high flow fittings.

With Air Regulator

7700C Pressure Settings - HS Air Cap	
Inlet	Air Cap
23PSI	10PSI
21PSI	9PSI
18.5PSI	8PSI
16.5PSI	7PSI
14PSI	6PSI
12PSI	5PSI
9.5PSI	4PSI
7PSI	3PSI
5PSI	2PSI

Chart shown with High Solids Air Cap, Turbine coupler with 1/4" x 1/4" adapter and regulator - no high flow fittings.

* All tests performed with Material Screw open 2 full turns, full trigger pull and 3/8" x 20' air hose with high flow fittings from wall regulator forward. High flow fittings only reduce the sealed pressure needed to achieve 10PSI at the air cap, but does not reduce the amount of inlet flow pressure needed to achieve 10PSI Air Cap pressure. Pressure's quoted are flow pressures, sealed pressure's will vary depending on the size of your air compressor and any restrictions in the air lines.

Use these settings as a guideline. Always use the lowest pressure that produces the best atomization and visual results. This will provide the highest efficiency and lowest overspray. You are ready to spray. Follow the general spraying directions for the best operation of your spray gun. For further assistance please visit our website at www.hvlp.com or call our customer service associates at 888-900-4857 (HVLP).

4.5 Selecting Nozzles, Needles And Air Caps

The selection chart below is a general guideline of a recommended nozzle, needle and air cap size to use with various coatings and viscosities for the Apollo 7500 Atomizer spray guns. Different coatings as well as different brands often have properties that will work better with an alternative size nozzle and needle or alternative air cap. Most often our standard recommendation will work perfectly. Other times you might want to experiment with a different combination. (Nozzle and needle sizes always need to be paired).

In general, a smaller nozzle size would be used for a thin or low viscosity product. This helps control the flow of fluid and ensure that all of the fluid is properly atomized. As viscosity increases, or higher fluid flow is desired, a larger nozzle/needle pair is suggested as well as a matching air cap.

Apollo offers two different air cap sets. Our standard air caps for fine atomization and distribution of coating (Available in sizes A, B, C and D) and our HS (High Solids) air caps designed to increase nozzle pressure for hard to atomize and higher solids products.

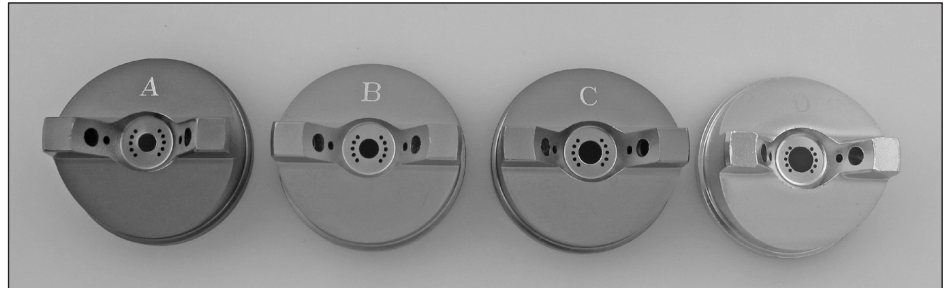

Standard Air Caps

The HS series is available in sizes B, C and D. For further assistance please visit our website at www.hvlp.com or call our customer service associates at 888-900-4857 (HVLP).



High Solids Air Caps

NOTE: Every time you change nozzle sizes you will need to reseal the air distributor gasket, item #5. To do so, pull it out of the front of the air distributor and reinstall it so that it is flush with the front of the air distributor.

FLUID NOZZLES, NEEDLE ASSEMBLIES, AIR CAPS & VISCOSITY			
TIP/NEEDLE SIZE	APPLICATION	VISCOSITY ZAHN #2	AIR CAP
0.8MM(.031)	Inks, Dyes, Stains, extremely thin viscosity fluids, Water based finishes	16 seconds	A
1.0MM (.039)	All purpose, thin lacquers, thin enamels, Water based finishes, Automotive, Marine, Airplane finish	16-18 seconds	B or B-HS
1.3MM (0.051)	Same as 1.0mm above except slightly higher viscosity	17-20 seconds	B or B-HS
1.5MM (.059)	Catalyzed lacquers, Conversion Varnish, Primers, Automotive, Marine, Airplane finishes, Varnish, High Viscosity Industrial Coatings, Urethanes, Enamels.	18-24 seconds	B or B-HS
1.8MM (0.07)	Same as 1.5mm above except slightly higher viscosity	20-22 seconds	C or C-HS
2.0MM (.079)	Thinned latex paint, Multi-spec, Heavy Primers, Butyrate, nitrate dope, High Viscosity Industrial Coatings	24-35 seconds	C or C-HS
2.5MM (.098)	Thinned latex paint, Multi-spec, Solvent adhesives, Wax based strippers	35+ seconds	D or D-HS

7700 Nozzles and Needle Identification

When pairing the 7700 needles and nozzles together it is important to look at the markings on both the needle and the nozzle. The nozzle has the actual size laser marked onto the side of the nozzle itself. The needle has a stock number laser marked onto the shaft. The first 3 numbers of the stock number do not mean anything. The last 3-4 numbers are the size of the needle.

Below, we have put together a chart showing what the various nozzle sizes we offer for the 7700 series spray gun and the corresponding needle identification numbers which they are paired with. If you have any questions please give customer service a call at 1-888-900-4857.

Nozzle Size	Needle Identification
0.8mm	20108
1.0mm	20110
1.3mm	2011315
1.5mm	2011315
1.8mm	2011820
2.0mm	2011820
2.5mm	20125

Please note: The 1.3mm and 1.5mm nozzles use the same size needle. The 1.8mm and 2.0mm nozzles use the same size needle also. All other size nozzles are paired with only one needle size.

4.6 Understanding Your Viscosity Meter

Using the APOLLOSPRAY® viscosity meter is an accurate way of measuring the thickness/viscosity of a coating in order to ensure a fine finish. The viscosity meter will accurately measure many different varieties of materials including, but not limited to: Lacquers, Sealers, Enamels, Stains, Oils and Waterbornes.

TO USE:

Take a stopwatch, the APOLLOSPRAY® viscosity meter and the coating/material/paint to be measured.

1. Dip the Viscosity meter into the coating.
2. Start the stopwatch as soon as you pull the cup out of the coating.
3. The coating will run out of the hole in the bottom of the cup in a steady stream.
4. As soon as you see the FIRST break in the stream, stop the watch. The time shown is equivalent to #2 Zahn seconds.
5. Clean the cup and store.

If the time you get is more than the recommended or desired time, then you need to thin your material. Use the appropriate thinner to the correct proportion for your mixture. Retest, following steps 1-4. Continue to thin until the desired viscosity is reached or until you reach the maximum thinning recommended by the manufacturer of the coating you are trying to spray. For further assistance please visit our website at www.hvlp.com or call our customer service associates at 888-900-4857 (HVLP).



4.7 Know Your Coating Properties

Coatings are a blend of resins and additives to create a product that will provide a protective and beautifying surface to your work piece. Different resins have different properties. It is important to use the correct coating to achieve a desired result. Manufacturers of coatings can control the resin solids content, production viscosity, sheen, color, flow-out enhancement and other properties as well. Some products offer ways to adjust the coating properties such as speeding up or slowing down the drying time, adding catalysts to strengthen the molecular bond or adding flattening agents to lower the sheen. Manufacturers will often give some guidelines on how to thin their product for spray application. There are many different types of spray equipment in use. Coatings manufacturers cannot address all of them. It is important for the finisher to understand the spray equipment and to use common sense to arrive at the correct fluid viscosity to produce the best possible results with the selected coating and the equipment being used.

4.7.1 Your Choice Of Coatings And Viscosity

Extremely thin, watery or light bodied fluids such as inks, aniline dyes and oil stains can generally be used straight from the can. Most water based finishing products are also formulated to be used straight from the can without thinning with a 3 stage or larger turbine. Most other coating products will need to be thinned anywhere from 10% to 50% depending on the available air pressure of the turbine model and the properties of the coating selected.

4.8 Apollo HVLP Turbine Properties

Each Apollo Turbine Unit offers the finisher a maximum operating pressure. This pressure is determined by the size and output of the unit you have selected. The maximum available pressure will have a direct bearing upon the viscosity of the fluid that you choose to spray. Atomizing pressure and fluid viscosity directly relate to the efficiency of the equipment operation and the quality of the results that you will achieve. Apollo Models 835VR and 1050VR offer the additional option to reduce and set atomizing pressure with the variable speed control installed on these units including an accurate pressure display module.

Model	Turbine Size	Sealed Max Pressure
700, 725	2 Stage	4.5 PSI, 0.31 BAR
800, 825, ECO-MINI	3 Stage	5.5 PSI, 0.38 BAR
835, 835VR, ECO-3, POWER-3	3 Stage	7.0 PSI, 0.48 BAR
900	3 Stage	6.0 PSI, 0.41 BAR
1000, 1025	4 Stage	8.0 PSI, 0.55 BAR
1035, POWER-4	4 Stage	9.0 PSI, 0.62 BAR
1050, 1050VR, POWER-5, PRECISION-5	5 Stage	9.5 PSI, 0.70 BAR
1100	Multi Stage	3.5 PSI—10 PSI, 0.24 BAR- 0.69 BAR
1200	Multi Stage	3.5 PSI—10 PSI, 0.24 BAR- 0.69 BAR
PRECISION-6	Multi Stage	14.5 PSI, 1.0 BAR

4.9 Cleaning Your 7700 AtomiZer® Spray Gun

After you have finished spraying, follow these simple steps to clean your Apollo spray gun:

4.9.1 Partial Cleaning

Cleaning your 7700 AtomiZer spray gun does not have to be a difficult task. Often, when spraying a variety of clear coatings, a thorough rinsing and wiping of basic parts is all that may be necessary. The basic steps below are for simple and easy cleaning of your Apollo 7700 AtomiZer spray gun.

1. Empty any unused material (paint) from the cup and wash out any residue with an appropriate cleaner compatible with the coating, or water if using water-based material. Partially fill the cup with cleaner and spray through the gun to flush out the material passages.
2. Remove the Air Cap (#3) and clean. Ensure that all the air holes in the air cap are clean.
3. Using a brush and solvent, remove any paint deposits on the outer surface of the tip/nozzle (#4). (Apollo FS1900 cleaning brush kit recommended).
4. Unscrew and remove the Material Adjustment Screw (#20).
5. Remove the needle spring (#21).
6. Pull the trigger and then pull the needle (#22) out through the back of the spray gun.
7. Remove the fluid nozzle (#4) with the wrench (spanner) provided.
8. Clean both fluid nozzle and needle assembly using cleaner or water and a brush.
9. Reassemble following the instructions in the next section for thorough cleaning. Make sure to oil the needle spring (#21), the Air Valve Stem (#15) and the Gland Nut (#24) to prevent the needle from sticking.
10. To adjust the Gland nut (#24) tighten until the needle sticks, then back off the nut about 1/8 turn. Do not over tighten the gland nut or the needle will stick. Do not under tighten or the Gland Seal will leak.
11. Check the Cup Top Gasket and replace if damaged. Always seat the cup top gasket flat in the cup groove. Failure to do this will allow the cup to drip and impair the spray pattern due to loss of cup pressure.

NOTE: When reassembling your spray gun, do not tighten down the Air Cap Ring (#1). This will ensure that if there is any material residue on the threads it will not dry and seal itself to the Air Distributor (#7).

4.9.2 Thorough Cleaning

Follow steps above for partial cleaning.

To further disassemble the spray gun now that you have already removed the air cap ring (#1), air cap (#3), fluid nozzle (#4) and needle (#22), locate the air cap seal (#5). To remove the air cap seal, lay the spray gun on its side.

1. Locate the small groove on the air cap seal. You can rotate the groove to a comfortable position for removal. (3 o'clock or 9 o'clock).

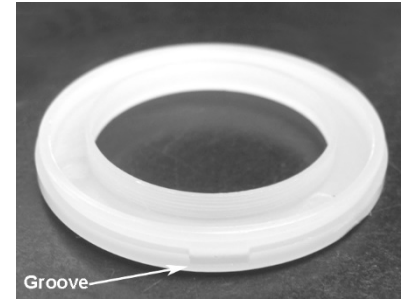

2. Place the flat tip of the wrench (spanner) in the air cap seal groove. Push in and pry up until the air cap seal pops out. (Clean if necessary).



3. Remove the air distributor (#7) and clean if necessary.

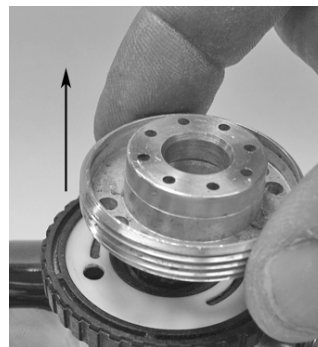

3. Remove the fan adjustment ring (#9) and air distributor plate (#8). The air distributor plate is attached to the ring. These two pieces separate. Clean them both if necessary.



Note: Make sure you reassemble the two pieces correctly or you will only get a round fan pattern.

4. Remove the fan adjustment seal (#10). Clean if necessary.



4.9.3 Re-Assemble The Spray Gun

1. Insert the fan adjustment seal (#10).



2. Insert the fan adjustment ring and air distributor plate. (#8 and #9). If you have separated these two pieces it is critical that the white air distributor plate is correctly re-inserted into the fan adjustment ring. Note that the open slots on the air distributor plate must be visible through the holes of the fan adjustment ring at the 12 o'clock and 6 o'clock positions.

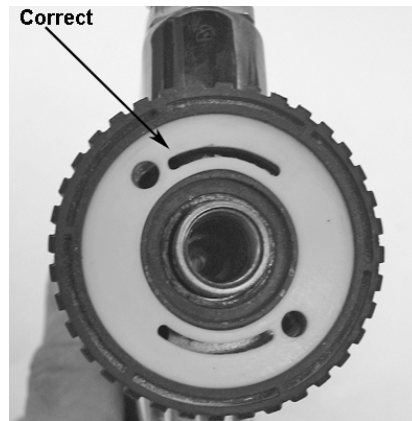

3. Using the back end of the needle, move the distributor plate so that the round hole is at the 5 o'clock position. DO NOT put the distributor plate and fan adjustment ring together as show in the picture marked "incorrect". You will only be able to achieve a round spray pattern.

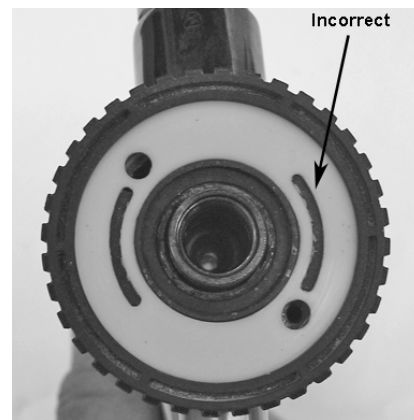

- Place the Air Distributor onto the body of the spray gun aligning the pin with the hole in the spray gun body at the 5 o'clock position.



- Screw the fluid nozzle (#4) back onto the spray gun, finger tight. Rotate the fan adjustment ring to be sure it rotates freely and easily. Tighten the nozzle slightly more with the wrench (spanner). Rotate fan adjustment ring again. Do not over tighten the fluid nozzle as it will stop the fan adjustment ring from rotating. If too tight, back off slightly. Be sure that the fluid nozzle is not too loose or leaking will occur.



- Insert the air cap seal (#5). To insert, observe both sides of the seal. One side should have three small circles. This side goes toward the spray gun. Snap the air cap seal onto the air distributor (#7).



- Push the needle (#22) back into the spray gun.



8. Insert the Needle spring into the Material Adjustment Screw (#20).

9. Install the Material Adjustment Screw with Needle Spring (#21).



10. Install air cap and air cap ring. Spray gun is now re-assembled and ready to use.



Periodically, use Apollo lubricant to lubricate the air valve bushing as shown.



11. Remove the Material Blanking Cap (#12) from either the gravity or bottom feed port of the spray gun and clean out any material.

NOTE: When reassembling your spray gun, do not tighten down the Air Cap Ring (#1). This will ensure that if there is any material residue on the threads it will not dry and seal itself to the Air Distributor (#7).

▲ CAUTION

Pressure will remain in the spray cup when unit is off. If you pull the trigger back, a stream of fluid will flow. To prevent accidents, turn material flow screw clockwise until it is completely closed. The trigger is now locked in the closed position.

To relieve the cup pressure prior to opening the cup use the twist connector located between the check valve and the cup lid. Undo the connector and the air pressure will exhaust through the tube. If you don't relieve the air pressure prior to opening the lid on the cup, paint can fly out and down the side of the cup.

5. Record Of Spray Gun Use

Record Of Spray Gun Use		
Model	Serial #	Date Purchased
Date	Hours Of Use	Total Hours

Turbine Recommended Maintenance: Clean and/or change pre-filters and/or cartridge filters every 50 hours or when necessary. See Accessories Page for appropriate filter replacement for your model.

6. Record Of Spray Gun Maintenance

Date	Hours Of Use	Total Hours

7. Troubleshooting

1. Your paint cup is full of material, the HVLP air is supplied to the spray gun, trigger is pulled and no paint comes out—
Reason: Cup not pressurizing.
 - A. Check Non-return valve installed correctly. (Black half facing toward cup)
 - B. Check Non-return valve. Clean or replace as necessary.
 - C. Check Air feed connector has a blockage. Check and clean as necessary.
 - D. Check to make sure the cup is clamped tight.
 - E. Check the cup top gasket to make sure that the gasket is not damaged or worn and that the cup is sealing correctly on it. Replace if necessary.
 - F. Gravity cup: check air pressure feed line is properly connected and not crimped.
 - G. Gravity cup: check the cup top gasket to make sure that the gasket is not damaged or worn and that the cup is sealing correctly on it. Replace if necessary.
2. If you think that you are getting too much “overspray” Try:
 - A. Moving the spray gun closer to the work (Turbine or compressor).
 - B. Reduce the fluid flow (Turbine or compressor)
 - C. Considering using a smaller nozzle and needle assembly (Turbine or compressor)
 - D. Reduce air pressure (Compressor or Precision series turbines)
3. If the sprayed surface is not flat and level after drying (orange peel effect) Try:
 - A. Increasing air pressure (Compressor or Turbine Models 835VR, 1050VR, 1100 & 1200, POWER-5, PRECISION-5, PRECISION-6)
 - B. Thin the coating more. (Turbine or compressor)
4. If the finish looks like “dry mist” or if you think the speed of the application is too slow. Try:
 - A. Increasing the fluid flow
 - B. Moving the spray gun slower
 - C. Moving the spray gun closer to the work piece
 - D. Thin the coating more.
5. Fan Pattern Control Ring is hard to rotate or will not turn. Try:
 - A. Loosening the fluid nozzle slightly. (Caution – Do not loosen to much or leakage will occur)
6. When rotating Fan Pattern Control Ring you only get a round spray pattern.
Try: Locate part (#8) Air Distributor Plate which is attached to part (#7) Air Distributor. The position of the air distributor plate is critical to the operation of the Fan Pattern Control Ring. (See page 29 for correct and incorrect position). Adjust if necessary.
7. When using a gravity cup fluid delivery is slow or fan pattern size too small.
Best performance with the gravity cup requires cup pressure.
Be sure that the air feed tube is attached from the Air Feed Connector (#23) to the nipple at the top of the cup.

If you have any additional questions please refer to our website located at www.hvlp.com or call our technical service line at 888-900-4857.

6. Diagram & Parts List

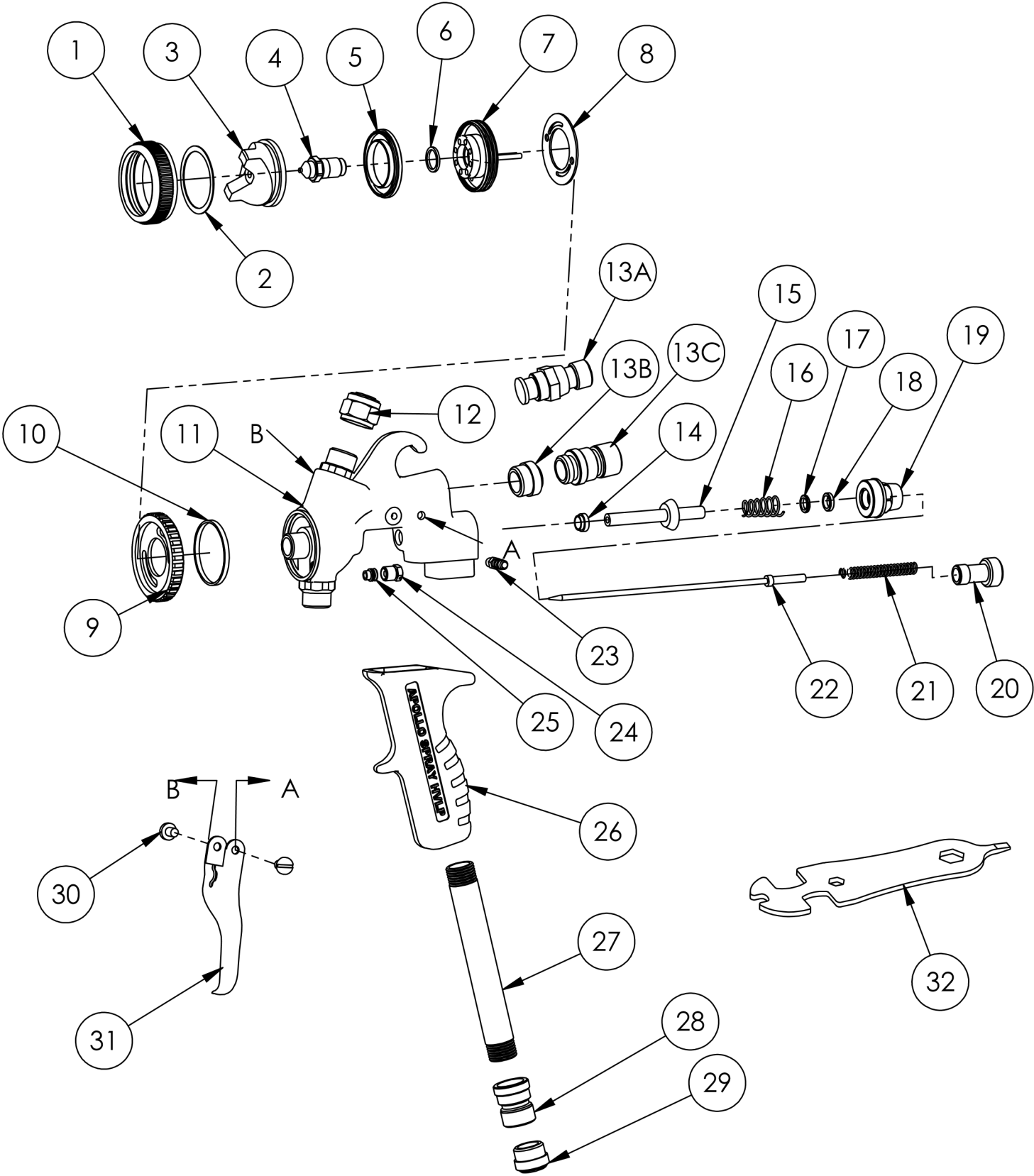

7700T Parts List			
ITEM #	QTY	PART #	DESCRIPTION
1	1	A7501-NS	AIR CAP RING
2	1	A7501-GK	AIR CAP RING GASKET
3	1	A7502-05-HS	AIR CAP - SIZE 0.5MM "CC-HS"
3	1	A7502-08	AIR CAP - SIZE 0.8MM "A"
3	1	A7502-10	AIR CAP - SIZE 1.0MM, 1.3MM, 1.5MM "B"
3	1	A7502-10-HS	AIR CAP - SIZE 1.0MM, 1.3MM, 1.5MM "B-HS"
3	1	A7502-18	AIR CAP - SIZE 1.8MM, 2.0MM "C"
3	1	A7502-18-HS	AIR CAP - SIZE 1.8MM, 2.0MM "C-HS"
3	1	A7502-25	AIR CAP - SIZE 2.5MM "D"
3	1	A7502-25-HS	AIR CAP - SIZE 2.5MM "D-HS"
4	1	A7503-05	FLUID NOZZLE - SIZE 0.5MM
4	1	A7503-08	FLUID NOZZLE - SIZE 0.8MM
4	1	A7503-10	FLUID NOZZLE - SIZE 1.0MM
4	1	A7503-13	FLUID NOZZLE - SIZE 1.3MM
4	1	A7503-15	FLUID NOZZLE - SIZE 1.5MM
4	1	A7503-18	FLUID NOZZLE - SIZE 1.8MM
4	1	A7503-20	FLUID NOZZLE - SIZE 2.0MM
4	1	A7503-25	FLUID NOZZLE - SIZE 2.5MM
5	1	A7504	AIR CAP SEAL
6	1	A7556	AIR DISTRIBUTOR GASKET
7	1	A7506-NS	AIR DISTRIBUTOR
8	1	A7507	AIR DISTRIBUTOR PLATE
9	1	A7508	FAN ADJUSTMENT RING
10	1	A7509	FAN ADJUSTMENT SEAL
11	1	A7510	SPRAY GUN BODY
12	1	A7533	MATERIAL BLANKING CAP
13A	1	A7546	OS CONTROL (OPTIONAL)
13B	1	A7513-HX	AIR BLANKING CAP (UPPER PORT)
13C	1	A7543	UPPER PORT HOSE COUPLER (OPTIONAL)
14	1	A7514	AIR VALVE BUSHING
15	1	A7515	AIR VALVE STEM
16	1	A7516	AIR VALVE RETURN SPRING
17	1	A7518	AIR VALVE RETAINING NUT GASKET
18	1	A7517	AIR VALVE SEATING GASKET
19	1	A7519	AIR VALVE RETAINING NUT
20	1	A7522	MATERIAL ADJUSTMENT SCREW
21	1	A7521	NEEDLE SPRING
22	1	A7520-05	NEEDLE ASSEMBLY - SIZE 0.5MM
22	1	A7520-08	NEEDLE ASSEMBLY - SIZE 0.8MM
22	1	A7520-10	NEEDLE ASSEMBLY - SIZE 1.0MM
22	1	A7520-1315	NEEDLE ASSEMBLY - SIZE 1.3MM
22	1	A7520-1315	NEEDLE ASSEMBLY - SIZE 1.5MM
22	1	A7520-1820	NEEDLE ASSEMBLY - SIZE 1.8MM
22	1	A7520-1820	NEEDLE ASSEMBLY - SIZE 2.0MM
22	1	A7520-25	NEEDLE ASSEMBLY - SIZE 2.5MM
23	1	A5211N	AIR FEED CONNECTOR
24	1	A7528	GLAND SEAL NUT
25	1	A7527	GLAND SEAL
26	1	A7524	HANDLE
27	1	A5226	HANDLE TUBE
28	1	A7526-HX	MALE QUICK CONNECT (TURBINE AIR)
29	1	A7544	AIR BLANKING CAP, HANDLE (OPTIONAL)
30	2	A7531	TRIGGER SCREW
31	1	A7532	TRIGGER
32	1	A7534	WRENCH

Model A5251

1 Quart Cup Assembly Parts List

Diagram #	Part #	Description
1	A5274	Center bolt/pick-up tube
2	A5276	Air Relief - Cap, Base & Gasket
2	A5276	Air Relief - Cap, Base & Gasket
3	A5271	Yoke
4	A5278	Lever
5	A5270	Cup top casting
6	A5280	Cup top gasket (White poly)
7	A4254	Material Filter
8	A5272	Cup top lock nut
9	A5324	Air Stem
10	A5299	Air Feed Tube
11	A5265	Non-return valve
12	A5275	Quick release cup

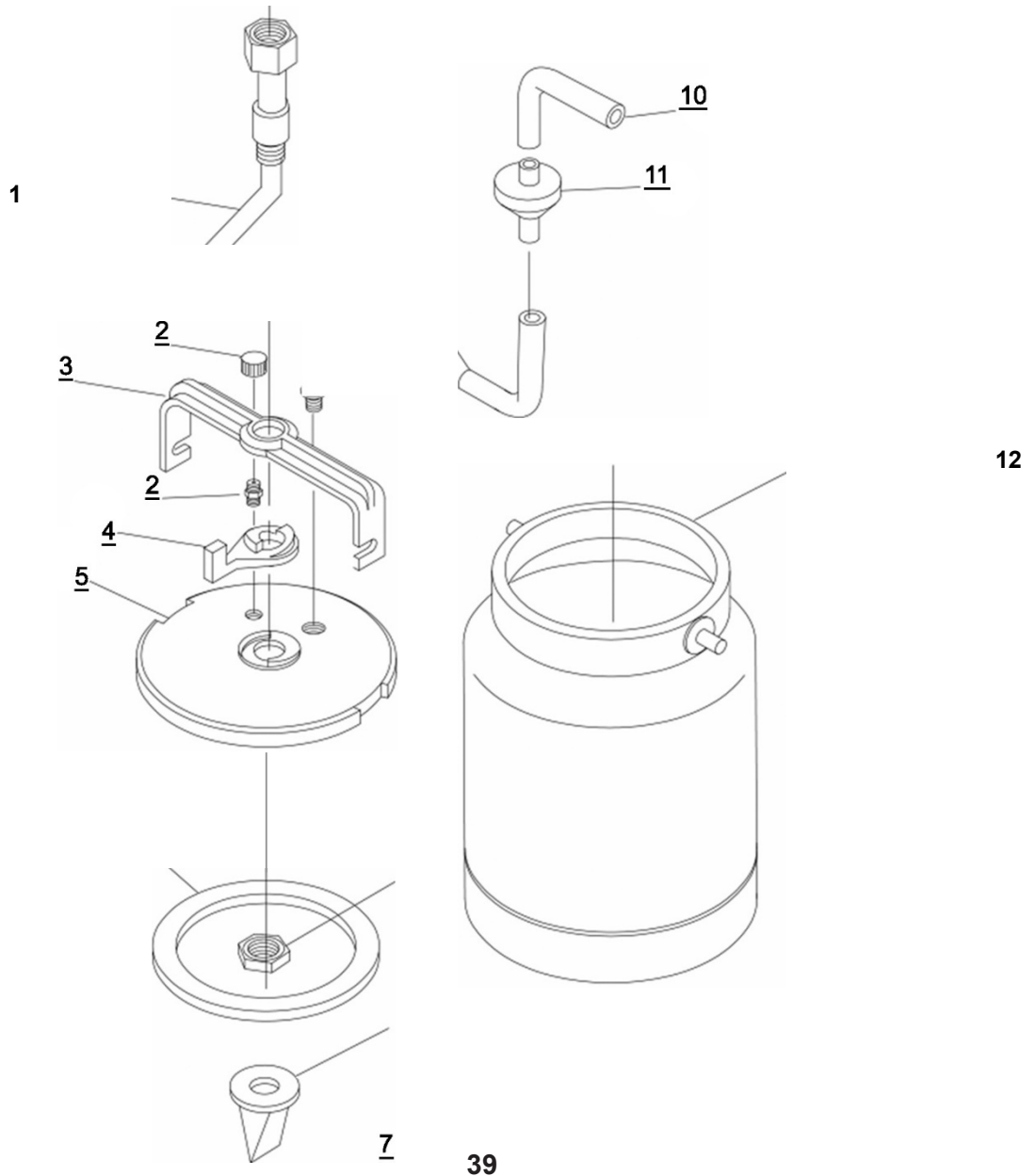

Gravity Cup Diagram & Parts List

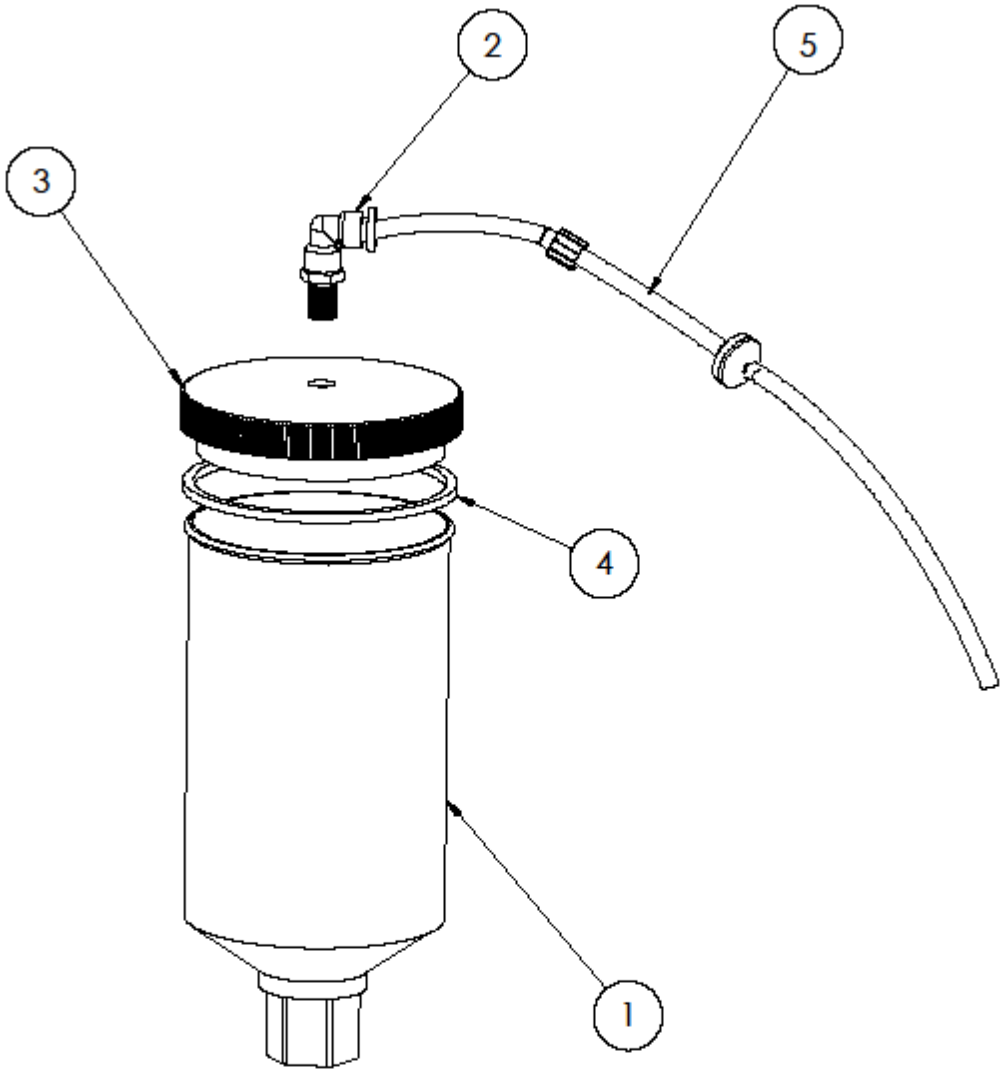

Gravity Cup Parts List

Diagram #	Part #	Description
1	A7555	90cc Non-teflon Cup w/lid
1	A5033	250cc Non-teflon Cup
1	A5034	600cc Non-teflon Cup
1	A7536	1000cc Non-teflon Cup
2	A5034-ELBOW	Swivel Connector for Gravity Cup Lid
3	A7555	90cc Non-teflon Cup w/lid
3	A5033-LID	Aluminum Cup Lid for 250cc Cup
3	A5034-LID	Aluminum Cup Lid for 600cc or 1000cc Cup
4	A7557	Gasket for 90cc Gravity Cup
4	A5037	Gasket for 250cc Gravity Cup
4	A5036	Gasket for 600cc or 1000cc Gravity Cup
5	A5232-G12	Air Feed Tube & Non-return Valve for Gravity Cup for 90cc, 250cc or 600cc
5	A5232-G16	Air Feed Tube & Non-return Valve for Gravity Cup for 1000cc

9. Warranty

Two Year Warranty

The Apollo 7700 AtomiZer® is WARRANTED by APOLLO SPRAYERS INTERNATIONAL, INC. for a total period of TWO YEARS from the ORIGINAL date of purchase by the ORIGINAL PURCHASER. Proof of purchase to be included and all SHIPPING CHARGES to be pre-paid.

APOLLO SPRAYERS INTERNATIONAL INC., upon examination of the machine/equipment will replace or repair at their discretion any defects in material or workmanship.

This WARRANTY does NOT include: misuse, damage, neglect, alterations, disassembled equipment or modifications, lack of maintenance, cleaning, water damage to electrical parts, INCORRECT VOLTAGE CONNECTION.

This Warranty is in lieu of all other express warranties, any WARRANTY implied by law, including but not limited to, implied Warranties of merchantability or fitness, is excluded to the maximum extent permitted by law and, if not excludable, is limited to the duration of the express Warranty.

No representative or person is authorized to extend this Warranty or to create for APOLLO SPRAYERS INTERNATIONAL, INC. any other liability in connection with the sale of any APOLLO SPRAYERS product. APOLLO SPRAYERS INTERNATIONAL, INC. shall not be liable for any consequential, incidental or special damages of any kind directly or indirectly resulting from breach of any express or implied warranty.

Some states do allow the exclusion or limitation of incidental or consequential damages or limitations on the length of any Warranty so that the above limitations and exclusions may not apply to you: however, to the maximum extent permitted under applicable law, the only rights and remedies shall be to obtain a replacement for any defective product.

This Warranty gives you specific legal rights and you may also have other rights which vary from State to State.

Apollo Sprayers International, Inc.
1030 Joshua Way, Vista, CA 92081
Customer Service: (760) 727-6226
Fax: (760) 727-9325
Toll Free Sales: (888) 900-HVLP (4857)
www.hvlp.com

 **WARNING:** This product can expose you to chemicals including Chromium, which is known to the State of California to cause cancer and birth defects or other reproductive harm. For more information go to www.P65Warnings.ca.gov.