



For more information or replacement brushes visit us at taoclean.com



Call or text: +1-714-363-3599



Email: support@taoclean.com

Please Note:

This equipment has been tested and found to comply with the limits for a Class B digital device, pursuant to part 15 of the FCC Rules. These limits are designed to provide reasonable protection against harmful interference in a residential installation.

This equipment generates, uses and can radiate radio frequency energy and, if not installed and used in accordance with the instructions, may cause harmful interference to radio communications. However, there is no guarantee that interference will not occur in a particular installation. If this equipment does cause harmful interference to radio or television reception, which can be determined by turning the equipment off and on, the user is encouraged to try to correct the interference by one or more of the following measures:

- Reorient or relocate the receiving antenna.
- Increase the separation between the equipment and receiver.
- Connect the equipment into an outlet on a circuit different from that to which the receiver is connected.
- Consult the dealer or an experienced radio/TV technician for help.

Changes or modifications to this unit not expressly approved by the party responsible for compliance could void the user's authority to operate the equipment.

umma

GO

with
germshield

USER MANUAL

BA-0150



IMPORTANT

READ THIS USER MANUAL CAREFULLY
BEFORE YOU USE THE DEVICE. ALSO,
PLEASE SAVE IT FOR YOUR
FUTURE REFERENCE.



CONTACT

For assistance
call or text: +1-714-363-3599

T A C clean © 2022

All rights reserved. No part of this book may be reproduced, stored in a retrieval system, or transmitted in any form or by any means, electronic, mechanical, or otherwise, without written permission of the copyright owners.

This device complies with Part 15 of the FCC Rules. The operation of this device is subject to the following two conditions: (1) this device may not cause harmful interference, and (2) this device must accept any interference received, including interference that may cause undesired operation.

umma

GO

with
germshield

WELCOME TO A NEW ERA OF CLEANLINES

Congratulations on your new Umma Toothbrush. You've made a smart investment in your teeth and we're so happy and grateful you chose our system to care for them.

We have worked night and day to design our latest toothbrush and we want you to love it. To get you up and running as fast as possible and ensure the best from your Umma Toothbrush & UV sanitizer, please take a moment to read these instructions.

What follows are steps to help you understand how to charge your system, operate and keep it maintained to ensure the best performance for superior results, and some technical information, just in case you love engineering as much as we do.

⚠️ ATTENTION ⚠️

WHEN USING ELECTRICAL DEVICES, BASIC SAFETY PRECAUTIONS SHOULD ALWAYS BE FOLLOWED

USB POWER ADAPTER NOT INCLUDED. USE WITH A POWER ADAPTER RATED AT 5V - 1A OR ABOVE

CHILDREN SHALL NOT PLAY WITH THE DEVICE.

CHILDREN SHALL NOT CLEAN OR CARRY OUT USER MAINTENANCE WITHOUT ADULT SUPERVISION. THANK YOU.

THIS APPLIANCE CAN BE USED BY CHILDREN FROM 8 YEARS OF AGE SO LONG THEY ARE SUPERVISED OR HAVE BEEN GIVEN INSTRUCTIONS CONCERNING THE USE AND OPERATION OF THE DEVICE IN A SAFE MANNER. THE CHILD MUST UNDERSTAND MISUSE OF THE DEVICE COULD BE DANGEROUS, HARMFUL AND HAZARDOUS TO THE CHILD'S HEALTH AND SAFETY.

⚠️ DANGER ⚠️

THIS APPLIANCE CONTAINS A UV EMITTER. DO NOT STARE AT THE LIGHT SOURCE.

UV LIGHT CAN BE HARMFUL TO THE HUMAN EYE AND SKIN.

NEVER FORCE THE USB CABLE INTO AN OUTLET.

IF THE USB CABLE DOES NOT EASILY FIT INTO THE OUTLET AND/OR MICRO USB TO THE HANDLE, DISCONTINUE USE AND CONTACT TAO CLEAN FOR SERVICE. THANK YOU.

CONTACT THE TAO CLEAN CUSTOMER CARE FOR ASSISTANCE, PLEASE TEXT OR CALL +1 (714) 363-3599 OR EMAIL: SUPPORT@TAOCLEAN.COM

⚠️ DANGER ⚠️

DO NOT PLUG THE HANDLE INTO AN OUTLET WITH A VOLTAGE OR FREQUENCY OTHER THAN SPECIFIED ON THE CHARGER. PLEASE BE AWARE VOLTAGE CONVERTERS DO NOT GUARANTEE VOLTAGE COMPATIBILITY. SO BE VIGILANT AND MOST OF ALL BE SAFE.

⚠️ WARNING ⚡

IF THE DEVICE IS DAMAGED IN ANY WAY (BRUSH HEAD, TOOTHBRUSH HANDLE, CHARGER AND/OR SANITIZER), STOP USING IT.

IN CASE OF ANY MECHANICAL FAILURE WITHIN THE WARRANTY PERIOD, PLEASE RETURN YOUR TAO CLEAN SYSTEM FOR SERVICE. DO NOT ATTEMPT TO DISMANTLE. DISMANTLING THE DEVICE WILL VOID THE WARRANTY.

THIS DEVICE CONTAINS NO SERVICEABLE PARTS. IF THE APPLIANCE IS DAMAGED, CONTACT THE TAO CLEAN CUSTOMER CARE FOR ASSISTANCE, PLEASE TEXT OR CALL +1 (714) 363-3599 OR EMAIL: SUPPORT@TAOCLEAN.COM

THIS DEVICE HAS BEEN DESIGNED ONLY FOR CLEANING THE TEETH. DO NOT USE IT FOR ANY OTHER PURPOSE. STOP USING THE APPLIANCE AND CONTACT YOUR DENTIST IF YOU EXPERIENCE ANY DISCOMFORT OR PAIN.

**UMMA WAS DESIGNED FOR PERSONAL USE
- WE DO NOT RECOMMEND THAT YOU SHARE THE BRUSH HEADS.**

DO NOT PUT THE BRUSH HEAD, THE HANDLE, THE CHARGER, AND/OR THE SANITIZER IN THE DISHWASHER.

FEATURES

CLEANING MODE

germshield

Germ Shield technology delivers our standard level of sanitization. In addition, we designed the UV sanitizer to protect and enclose the toothbrush from environmental pollutants, coupled with the UV-C lamp to sanitize the toothbrush.

The UV-C light bulb helps kill germs on the brush head, keeping your toothbrush clean; drop the handle in the cleaning station and let it do its thing.

The light will glow blue as the cleaning cycle begins and slow pulse. After 4 minutes, the light will switch off.

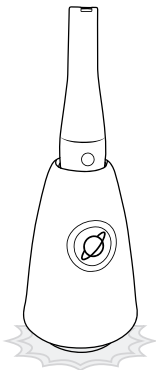

ATTENTION

TO ENSURE YOUR UV SANITIZER PERFORMS ITS TASKS PERFECTLY, PLEASE MAKE SURE YOUR SANITIZER IS PLACED ON A CLEAN, FLAT HORIZONTAL SURFACE.

PREPARING FOR USE

POWERING YOUR BASE

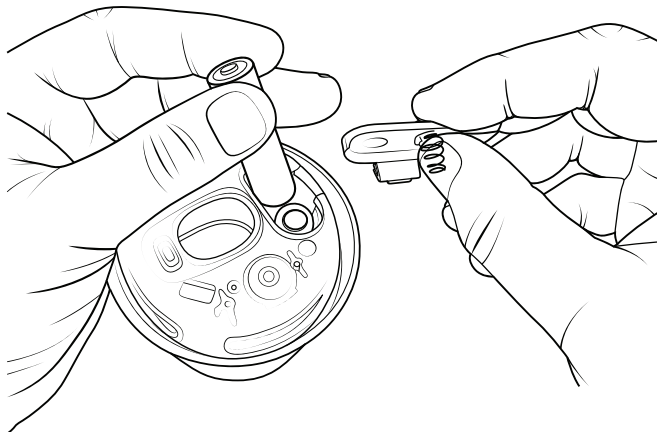

To power your base, use the AA batteries provided. Next, invert and find the removable door. Open and add the batteries, taking care of the orientation. Replace the door, and the device is ready to use.

ATTENTION

PLEASE ENSURE THE CORRECT BATTERY ORIENTATION TO ACTIVATE THE BASE.

PREPARING FOR USE

CHARGING YOUR HANDLE

To charge your handle use the USB cable provided. Find the Micro-USB port under the cover at the end of the handle. Flip open the door and use the small end to charge.

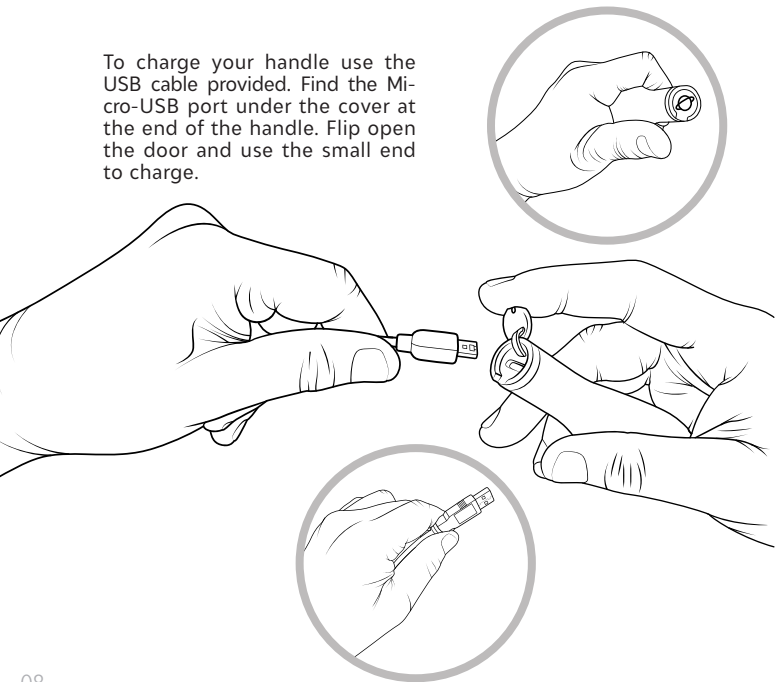

PREPARING FOR USE

BRUSH ASSEMBLY

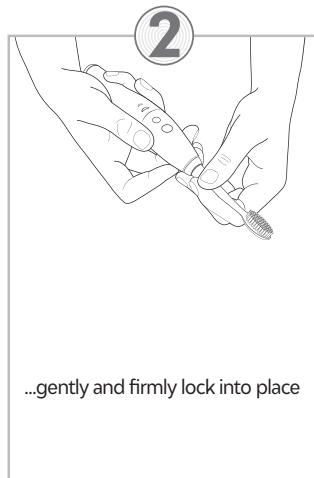
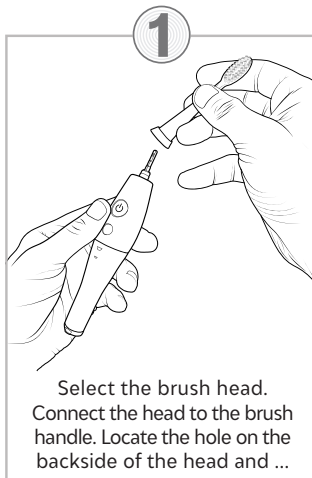

ATTENTION

**USE ONLY OFFICIAL TAO CLEAN
REPLACEMENT BRUSH HEADS.**

Replace brush heads every three months or sooner to achieve the best results. Fakes won't get the job done.

DIRECTIONS FOR USE

CONTROL PANEL

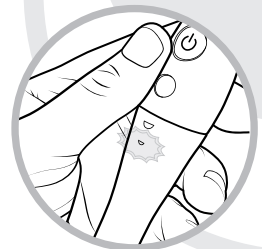
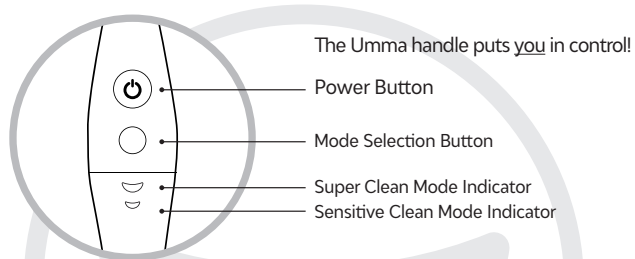

Press once for Sensitive Clean Mode and the small smiley will light up. Nice!



Press again to switch back to Super Clean Mode and the large smiley will light up. Easy!

ATTENTION

LOW BATTERY WARNING

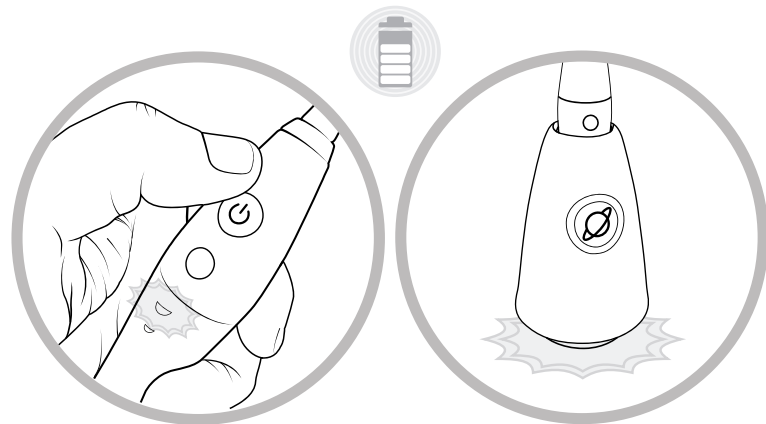

Umma has a low-battery indicator in both the base and the handle.

If it's flashing red on the handle, it can still be used in low-power mode but will need charging as soon as possible. Likewise, please replace the batteries when the base light starts flashing red.

USING THE DEVICE

BRUSHING MOTION

- Wet the bristles of your brush head and apply a small amount of your favorite toothpaste.
- Gently place the bristles against the teeth at a slight angle towards the gum line.
- Press the power button and lightly engage the brush with your teeth.
- Trust your brush: It will do all the brushing for you, so you do not need to apply the same pressure as a manual toothbrush. Sonic technology is superior in cleansing as compared to a manual toothbrush. Your Umma delivers thousands of brush strokes to safely dislodge debris, hygienically clean and efficiently polish your teeth without applying significant pressure. The brush is happy to clean, so do not press hard or scrub.



Hold the bristles in place against your teeth for a few seconds before sweeping on to the next tooth. Allow the brush to work the gums as well as the teeth.

- Your Umma Toothbrush delivers the dentist-recommended brushing time of two minutes. After the two minutes of brushing, the device stops automatically.
- At every 30-second interval, the brush will alert you to change brushing areas with a brief pause.

USING THE DEVICE

BRUSHING TECHNIQUE

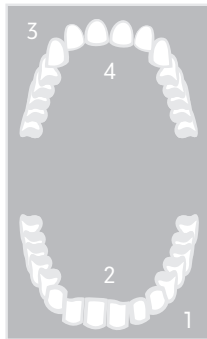

Optimal brushing technique

Separate your mouth into quadrants and begin brushing your outside bottom teeth.

(1) After the first pause, move to your inside bottom teeth.

(2) After the next pause, continue brushing the outside top teeth.

(3) The last pause signifies the home stretch along the inside top teeth.

The Umma bristles have been selected for their effectiveness when used appropriately. Avoid excessive pressure when brushing to ensure the longest life of the brush, but also the greatest effectiveness.

If you've got braces, keep smiling. Your Umma is effective on all types of braces and dental restorations (fillings, crowns, implants, and veneers).

After you've finished, feel free to conduct additional cleaning if you need to remove stains or like the feeling. Just go easy and don't press.

We also recommend that you don't use any abrasive toothpaste that may hurt the tooth enamel.

USING THE DEVICE

INTERCHANGEABLE HEADS

Our line of Daily Brush Heads is available in three different grades: sensitive, soft (included) and firm for a stiffer feel.

TAO Clean also offers specialty heads, such as orthodontic care and whitening.

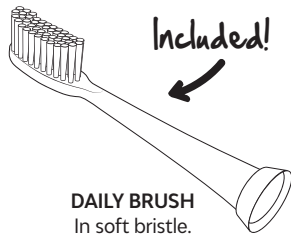

ORTHODONTIC HEAD

Our unique Umma Orthodontic Head has two specialized areas designed to get your teeth and dental furniture spotlessly clean.

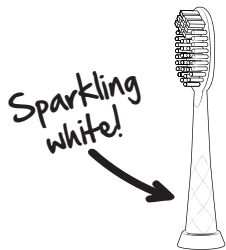

WHITENING TOOTHBRUSH

Our Umma Whitening Head uses proprietary bristles clinically proven to remove stains and whiten your smile.

MAINTENANCE

BRUSH CLEANING

Please follow these easy to do maintenance routines to ensure your Umma Toothbrush is always in the very best condition.

Keeping to these routines will also ensure your system is always operating at its best.

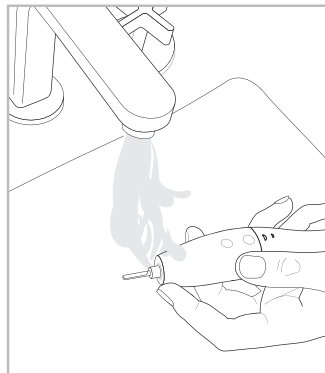

Essential Cleanliness Maintenance Routines Keep the Umma Clean

Always rinse the brush head and bristles after each use.

We recommend that you remove the brush head at least once a week and rinse the shaft area with warm water.

Be careful not to damage the seal on the shaft with sharp objects when you clean.

BASE CLEANING

Essential Cleanliness Maintenance Routines For The Station

We considered this when we designed the smooth curved interior shape of the UV sanitizer core. We do recommend cleaning once a week to ensure tip-top condition. Use a soft cloth. Wrap the fabric around your finger like so (see diagram no. 1). Unplug the station. Carefully run your finger around the bottom (see no. 2) and do the same around the top-docking hole (see no. 3).

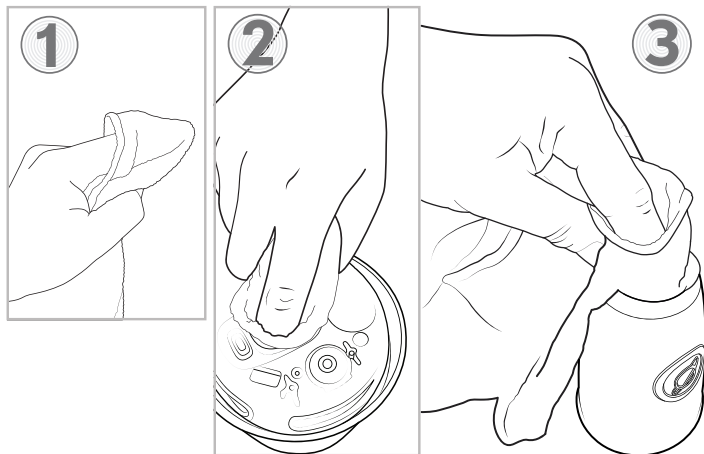

WARRANTY

Two year warranty

Your Umma is warranted against defects in workmanship and materials for two years for the original purchaser from the date of purchase. It does not cover damage or wear resulting from accidents, misuse, abuse, commercial use, or unauthorized adjustment and/or repair.

Please note: It does not cover wear of the brush heads.

There are no expressed warranties except as listed above. This warranty gives you specific legal rights, and you may have other rights which vary from state to state. Should your Umma Toothbrush require service (or replacement at our option) while under warranty, do not return to the retailer. Instead, please contact our customer service. Our friendly staff are trained to help you. If your Umma needs to be returned, we will arrange a return label.

For assistance: Text or call: +1 (714) 363-3599
Email: support@taoclean.com

Time to update your maintenance routine?

Come take a look on our website for new ideas to improve old routines - taoclean.com

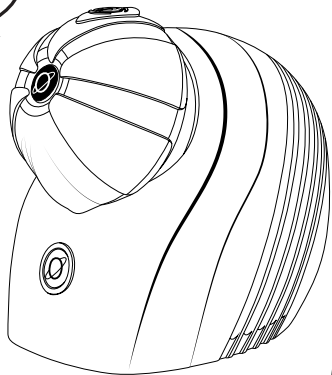

TIME FOR A NEW BRUSH HEAD?

Umma loves to keep you sparkling clean, and you deserve the best!
We recommend replacing your head every 3 months (or less).

Happy brush, happy life.

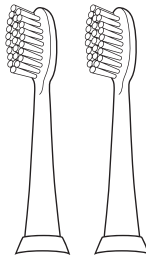

Replacement heads
www.taoclean.com

Accept no substitutes

