



# Headrests Order Form

P: (888) 317-9451  
F: (888) 216-8796  
E: sales@heartmobility.com

Company Name: \_\_\_\_\_  
Account #: \_\_\_\_\_  
Contact Name: \_\_\_\_\_  
Phone: \_\_\_\_\_  
Fax: \_\_\_\_\_  
Email: \_\_\_\_\_



**Mark if same as bill to.**

**Ship To:**  
Address: \_\_\_\_\_  
City: \_\_\_\_\_  
State: \_\_\_\_\_ ZIP Code: \_\_\_\_\_

**Bill To:**  
Address: \_\_\_\_\_  
City: \_\_\_\_\_  
State: \_\_\_\_\_ ZIP Code: \_\_\_\_\_

## Love Series Occipital & Sub Occipital Headrest Supports with Hardware

	Min-Max Wing Span	Height	Thickness
Small Love Cradle	7" – 12"	7"	1.5"
Medium Love Cradle	9" – 15"	9"	1.5"
Large Love Cradle	10" – 17"	11"	1.5"
Note: Love Cradles can be bent using no tools from min to max wing span			

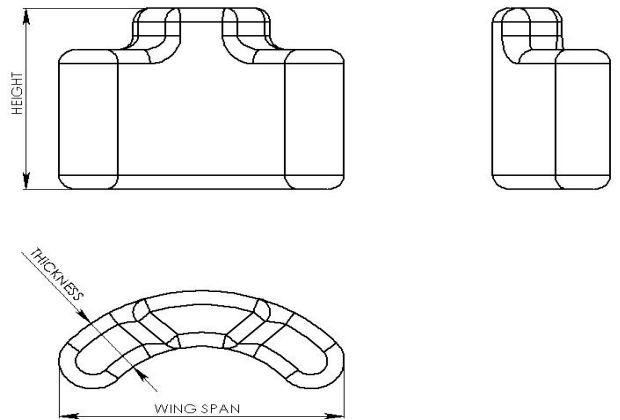

### HCPCS

- Small Love Cradle with Desire Hardware **LCSDH.....415** (E0955, E1028 & E0966)
- Medium Love Cradle with Desire Hardware **LCMDH.....465** (E0955, E1028 & E0966)
- Large Love Cradle with Desire Hardware **LCLDH.....515** (E0955, E1028 & E0966)
- Custom Love Cradle with Desire Hardware **LCCDH.....Quote** (E0955, E1028 & E0966)
- Small Love Cradle with Passion Hardware **LCSPH.....365** (E0955 & E1028)
- Medium Love Cradle with Passion Hardware **LCMPH.....415** (E0955 & E1028)
- Large Love Cradle with Passion Hardware **LCLPH.....465** (E0955 & E1028)
- Custom Love Cradle with Passion Hardware **LCCPH.....Quote** (E0955 & E1028)
- Small Love Cradle with Bold Hardware **LCSBH.....300** (E0955)
- Medium Love Cradle with Bold Hardware **LCMBH.....350** (E0955)
- Large Love Cradle with Bold Hardware **LCLBH.....400** (E0955)
- Custom Love Cradle with Bold Hardware **LCCBH.....Quote** (E0955)

HCPCS codes are not to be used as legal or billing advice. Providers are responsible for determining the appropriate codes for Medicare.



**Love Series Occipital & Sub Occipital Headrest Supports**

			<b>HCPCS</b>
Small Love Cradle	♥ <b>LCS</b> .....	<b>200</b>	(E0955)
Medium Love Cradle	♥ <b>LCM</b> .....	<b>250</b>	(E0955)
Large Love Cradle	♥ <b>LCL</b> .....	<b>300</b>	(E0955)
Custom Love Cradle	♥ <b>LCC</b> .....	<b>Quote</b>	(E0955)

**Love Series Occipital & Sub Occipital Covers**

			<b>HCPCS</b>
Small Love Cradle Cover	♥♥ <b>LCCS</b> .....	<b>80</b>	(K0108)
Medium Love Cradle Cover	♥♥ <b>LCCM</b> .....	<b>90</b>	(K0108)
Large Love Cradle Cover	♥♥ <b>LCCL</b> .....	<b>100</b>	(K0108)
Custom Love Cradle Cover	♥♥ <b>LCCC</b> .....	<b>Quote</b>	(K0108)

**Reaction Series Occipital & Sub Occipital Headrest Supports with Hardware**



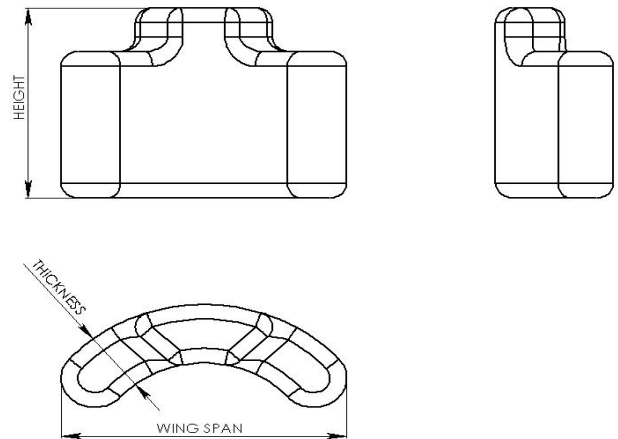



	Wing Span	Height	Thickness
<b>Small Love Cradle</b>	<b>12"</b>	<b>7"</b>	<b>1.5"</b>
<b>Medium Love Cradle</b>	<b>15"</b>	<b>9"</b>	<b>1.5"</b>
<b>Large Love Cradle</b>	<b>17"</b>	<b>11"</b>	<b>1.5"</b>
Note: Reaction cradles cannot be bent and are fixed sizes			







			<b>HCPCS</b>
Small Reaction Cradle with Desire Hardware	♥♥ <b>RCSDH</b> .....	<b>415</b>	(E0955, E1028 & E0966)
Medium Reaction Cradle with Desire Hardware	♥♥ <b>RCMDH</b> .....	<b>465</b>	(E0955, E1028 & E0966)
Large Reaction Cradle with Desire Hardware	♥♥ <b>RCLDH</b> .....	<b>515</b>	(E0955, E1028 & E0966)
Custom Reaction Cradle with Desire Hardware	♥♥ <b>RCCDH</b> .....	<b>Quote</b>	(E0955, E1028 & E0966)
Small Reaction Cradle with Passion Hardware	♥♥ <b>RCSPH</b> .....	<b>365</b>	(E0955 & E1028)
Medium Reaction Cradle with Passion Hardware	♥♥ <b>RCMPH</b> .....	<b>415</b>	(E0955 & E1028)

HCPCS codes are not to be used as legal or billing advice. Providers are responsible for determining the appropriate codes for Medicare.







Large Reaction Cradle with Passion Hardware		<b>RCLPH.....465</b>	(E0955 & E1028)
Custom Reaction Cradle with Passion Hardware		<b>RCCPH.....Quote</b>	(E0955 & E1028)
Small Reaction Cradle with Bold Hardware		<b>RCSBH.....300</b>	(E0955)
Medium Reaction Cradle with Bold Hardware		<b>RCMBH.....350</b>	(E0955)
Large Reaction Cradle with Bold Hardware		<b>RCLBH.....400</b>	(E0955)
Custom Reaction Cradle with Bold Hardware		<b>RCCBH.....Quote</b>	(E0955)





**Reaction Series Occipital & Sub Occipital Headrest Supports**

			<b>HCPCS</b>
Small Reaction Cradle		<b>RCS.....200</b>	(E0955)
Medium Reaction Cradle		<b>RCM.....250</b>	(E0955)
Large Reaction Cradle		<b>RCL.....300</b>	(E0955)
Custom Reaction Cradle		<b>RCC.....Quote</b>	(E0955)

**Reaction Series Occipital & Sub Occipital Covers**

			<b>HCPCS</b>
Small Reaction Cradle Cover		<b>RCCS.....80</b>	(K0108)
Medium Reaction Cradle Cover		<b>RCCM.....90</b>	(K0108)
Large Reaction Cradle Cover		<b>RCCL.....100</b>	(K0108)
Custom Reaction Cradle Cover		<b>RCCC.....Quote</b>	(K0108)

**Hardware Options**

			<b>HCPCS</b>
Desire Headrest Hardware		<b>DHH.....275</b>	(E0966 & E1028)
Headrest Hardware Extension		<b>HHE.....125</b>	(E0966)
Passion Headrest Hardware		<b>PHH.....225</b>	(E1028)
Bold Headrest Hardware		<b>BHH.....175</b>	(E1028)
Custom Headrest Hardware		<b>CHH.....Quote</b>	(E1028)