



Backing
Order Form

P: (888) 317-9451
F: (888) 216-8796
E: sales@heartmobility.com

Company Name: _____
Account #: _____
Contact Name: _____
Phone: _____
Fax: _____
Email: _____



Mark if same as bill to.

Bill To:
Address: _____
City: _____
State: _____ ZIP Code: _____

Ship To:
Address: _____
City: _____
State: _____ ZIP Code: _____

Back Selection Guide is Outlined below:

- Step 1: Fill out the back guide below**
- Step 2: Find the back below and fill in the exact dimensions**
- Step 3: Fill in the heart with the appropriate number**

Seat Guide

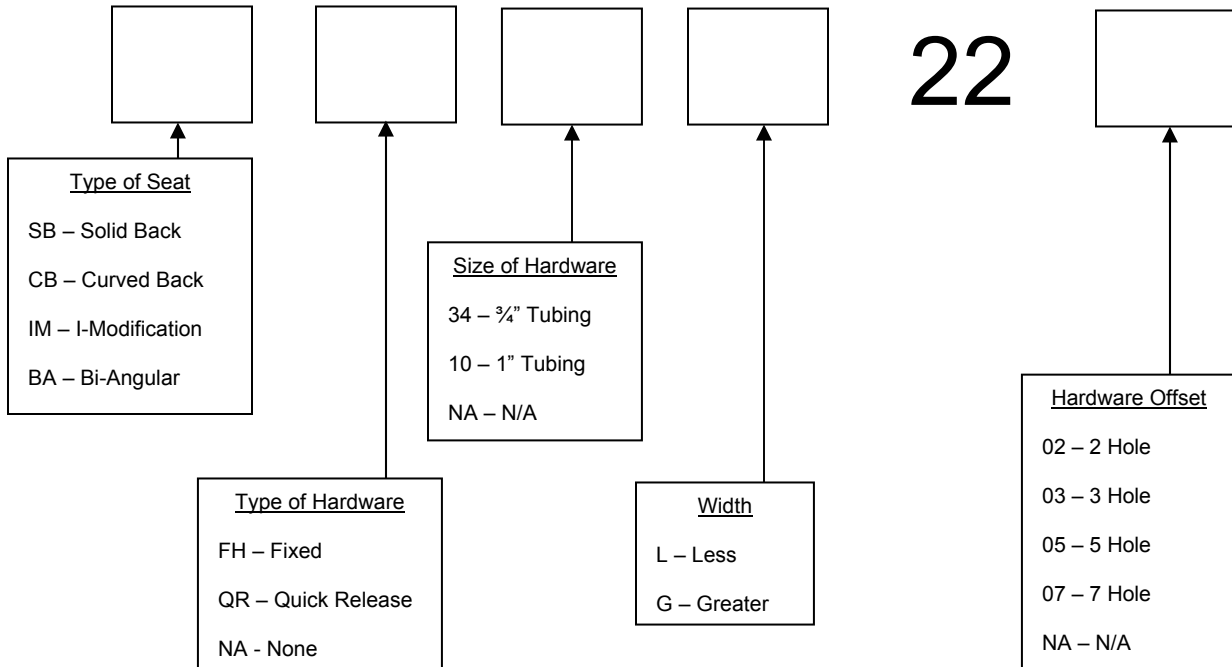

Example

Step 1:

SB FH 34 L 22 02

The above number is a SBFH34L2202 which in words means a solid back fixed hardware $\frac{3}{4}$ " in size less than 22" wide with 2 Hole mounting hardware.

Step 2:

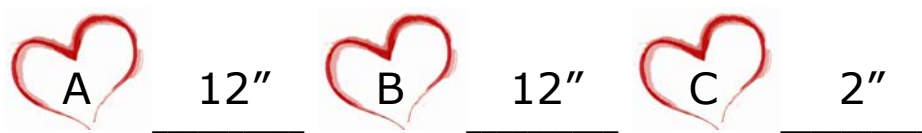
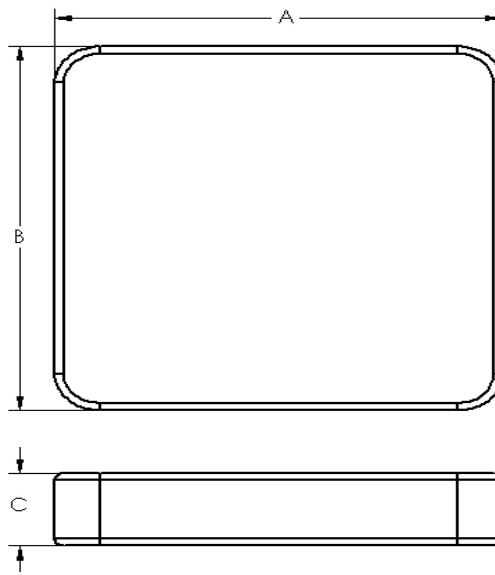

The above dimensions show a selection of 12" in width, 12" in depth and 2" thickness.

Step 3:

HCPCS

Solid Back less than 22" wide with $\frac{3}{4}$ " Fixed 2 Hole Hardware



SBFH34L2202.....450 E2613 & K0108

The last step pulls steps one and two together. Using the information from step one you select the appropriate heart and fill it in. Then you can see the corresponding price and HCPC code that goes with the seat you selected.



Backing
Order Form

P: (888) 317-9451
F: (888) 216-8796
E: sales@heartmobility.com

Solid Back

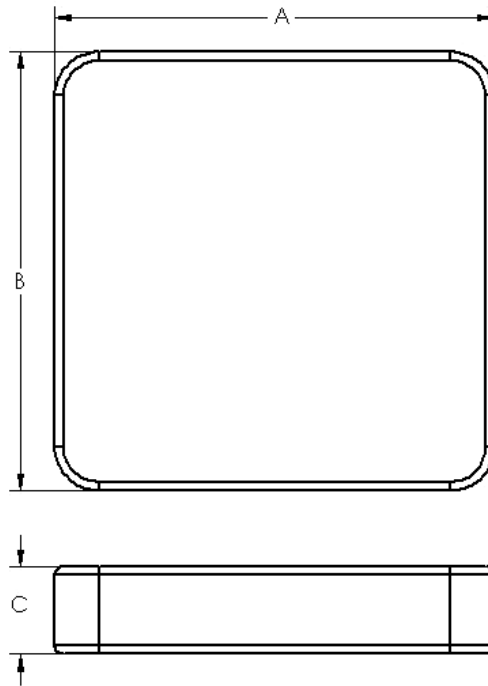



			HCPCS
Solid Back less than 22" wide	SBNANAL22NA	350	E2613
Solid Back greater than 22" wide	SBNANAG22NA	400	E2614
Solid Back less than 22" wide with 3/4" Fixed 2 Hole Hardware	SBFH34L2202	450	E2613 & K0108
Solid Back less than 22" wide with 3/4" Fixed 3 Hole Hardware	SBFH34L2203	450	E2613 & K0108
Solid Back less than 22" wide with 3/4" Fixed 5 Hole Hardware	SBFH34L2205	450	E2613 & K0108
Solid Back less than 22" wide with 3/4" Fixed 7 Hole Hardware	SBFH34L2207	450	E2613 & K0108
Solid Back greater than 22" wide with 3/4" Fixed 2 Hole Hardware	SBFH34G2202	500	E2614 & K0108
Solid Back greater than 22" wide with 3/4" Fixed 3 Hole Hardware	SBFH34G2203	500	E2614 & K0108
Solid Back greater than 22" wide with 3/4" Fixed 5 Hole Hardware	SBFH34G2205	500	E2614 & K0108
Solid Back greater than 22" wide with 3/4" Fixed 7 Hole Hardware	SBFH34G2207	500	E2614 & K0108
Solid Back less than 22" wide with 1" Fixed 2 Hole Hardware	SBFH10L2202	450	E2613 & K0108

HCPCS codes are not to be used as legal or billing advice. Providers are responsible for determining the appropriate codes for Medicare.



Backing Order Form

P: (888) 317-9451
F: (888) 216-8796
E: sales@heartmobility.com
HCPCS

Solid Back less than 22" wide with 1" Fixed 3 Hole Hardware		SBFH10L2203.....450	E2613 & K0108
Solid Back less than 22" wide with 1" Fixed 5 Hole Hardware		SBFH10L2205.....450	E2613 & K0108
Solid Back less than 22" wide with 1" Fixed 7 Hole Hardware		SBFH10L2207.....450	E2613 & K0108
Solid Back greater than 22" wide with 1" Fixed 2 Hole Hardware		SBFH10G2202.....500	E2614 & K0108
Solid Back greater than 22" wide with 1" Fixed 3 Hole Hardware		SBFH10G2203.....500	E2614 & K0108
Solid Back greater than 22" wide with 1" Fixed 5 Hole Hardware		SBFH10G2205.....500	E2614 & K0108
Solid Back greater than 22" wide with 1" Fixed 7 Hole Hardware		SBFH10G2207.....500	E2614 & K0108
Solid Back less than 22" wide with 3/4" Quick Release 2 Hole Hardware		SBQR34L2202.....550	E2613 & K0108
Solid Back less than 22" wide with 3/4" Quick Release 3 Hole Hardware		SBQR34L2203.....550	E2613 & K0108
Solid Back less than 22" wide with 3/4" Quick Release 5 Hole Hardware		SBQR34L2205.....550	E2613 & K0108
Solid Back less than 22" wide with 3/4" Quick Release 7 Hole Hardware		SBQR34L2207.....550	E2613 & K0108
Solid Back greater than 22" wide with 3/4" Quick Release 2 Hole Hardware		SBQR34G2202.....600	E2614 & K0108
Solid Back greater than 22" wide with 3/4" Quick Release 3 Hole Hardware		SBQR34G2203.....600	E2614 & K0108
Solid Back greater than 22" wide with 3/4" Quick Release 5 Hole Hardware		SBQR34G2205.....600	E2614 & K0108
Solid Back greater than 22" wide with 3/4" Quick Release 7 Hole Hardware		SBQR34G2207.....600	E2614 & K0108
Solid Back less than 22" wide with 1" Quick Release 2 Hole Hardware		SBQR10L2202.....550	E2613 & K0108
Solid Back less than 22" wide with 1" Quick Release 3 Hole Hardware		SBQR10L2203.....550	E2613 & K0108
Solid Back less than 22" wide with 1" Quick Release 5 Hole Hardware		SBQR10L2205.....550	E2613 & K0108
Solid Back less than 22" wide with 1" Quick Release 7 Hole Hardware		SBQR10L2207.....550	E2613 & K0108
Solid Back greater than 22" wide with 1" Quick Release 2 Hole Hardware		SBQR10G2202.....600	E2614 & K0108
Solid Back greater than 22" wide with 1" Quick Release 3 Hole Hardware		SBQR10G2203.....600	E2614 & K0108
Solid Back greater than 22" wide with 1" Quick Release 5 Hole Hardware		SBQR10G2205.....600	E2614 & K0108
Solid Back greater than 22" wide with 1" Quick Release 7 Hole Hardware		SBQR10G2207.....600	E2614 & K0108

HCPCS codes are not to be used as legal or billing advice. Providers are responsible for determining the appropriate codes for Medicare.



Backing
Order Form

P: (888) 317-9451
F: (888) 216-8796
E: sales@heartmobility.com

Curved Back

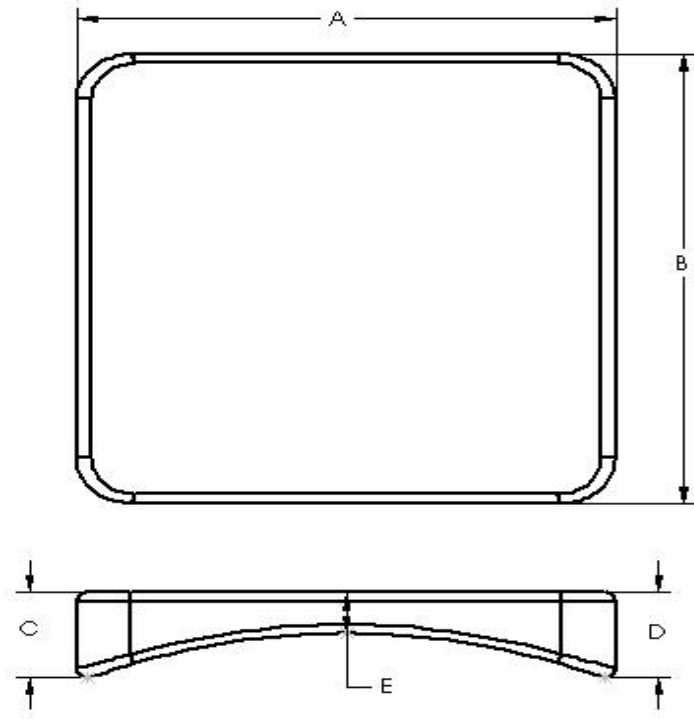

A _____ _____ _____
_____ _____ _____























			HCPCS
Curved Back less than 22" wide	CBNANAL22NA	350	E2613
Curved Back greater than 22" wide	CBNANAG22NA	400	E2614
Curved Back less than 22" wide with 3/4" Fixed 2 Hole Hardware	CBFH34L2202	450	E2613 & K0108
Curved Back less than 22" wide with 3/4" Fixed 3 Hole Hardware	CBFH34L2203	450	E2613 & K0108
Curved Back less than 22" wide with 3/4" Fixed 5 Hole Hardware	CBFH34L2205	450	E2613 & K0108
Curved Back less than 22" wide with 3/4" Fixed 7 Hole Hardware	CBFH34L2207	450	E2613 & K0108
Curved Back greater than 22" wide with 3/4" Fixed 2 Hole Hardware	CBFH34G2202	500	E2614 & K0108
Curved Back greater than 22" wide with 3/4" Fixed 3 Hole Hardware	CBFH34G2203	500	E2614 & K0108
Curved Back greater than 22" wide with 3/4" Fixed 5 Hole Hardware	CBFH34G2205	500	E2614 & K0108
Curved Back greater than 22" wide with 3/4" Fixed 7 Hole Hardware	CBFH34G2207	500	E2614 & K0108
Curved Back less than 22" wide with 1" Fixed 2 Hole Hardware	CBFH10L2202	450	E2613 & K0108

HCPCS codes are not to be used as legal or billing advice. Providers are responsible for determining the appropriate codes for Medicare.



Backing Order Form

P: (888) 317-9451
F: (888) 216-8796
E: sales@heartmobility.com
HCPCS

Curved Back less than 22" wide with 1" Fixed 3 Hole Hardware		CBFH10L2203.....450	E2613 & K0108
Curved Back less than 22" wide with 1" Fixed 5 Hole Hardware		CBFH10L2205.....450	E2613 & K0108
Curved Back less than 22" wide with 1" Fixed 7 Hole Hardware		CBFH10L2207.....450	E2613 & K0108
Curved Back greater than 22" wide with 1" Fixed 2 Hole Hardware		CBFH10G2202.....500	E2614 & K0108
Curved Back greater than 22" wide with 1" Fixed 3 Hole Hardware		CBFH10G2203.....500	E2614 & K0108
Curved Back greater than 22" wide with 1" Fixed 5 Hole Hardware		CBFH10G2205.....500	E2614 & K0108
Curved Back greater than 22" wide with 1" Fixed 7 Hole Hardware		CBFH10G2207.....500	E2614 & K0108
Curved Back less than 22" wide with 3/4" Quick Release 2 Hole Hardware		CBQR34L2202.....550	E2613 & K0108
Curved Back less than 22" wide with 3/4" Quick Release 3 Hole Hardware		CBQR34L2203.....550	E2613 & K0108
Curved Back less than 22" wide with 3/4" Quick Release 5 Hole Hardware		CBQR34L2205.....550	E2613 & K0108
Curved Back less than 22" wide with 3/4" Quick Release 7 Hole Hardware		CBQR34L2207.....550	E2613 & K0108
Curved Back greater than 22" wide with 3/4" Quick Release 2 Hole Hardware		CBQR34G2202.....600	E2614 & K0108
Curved Back greater than 22" wide with 3/4" Quick Release 3 Hole Hardware		CBQR34G2203.....600	E2614 & K0108
Curved Back greater than 22" wide with 3/4" Quick Release 5 Hole Hardware		CBQR34G2205.....600	E2614 & K0108
Curved Back greater than 22" wide with 3/4" Quick Release 7 Hole Hardware		CBQR34G2207.....600	E2614 & K0108
Curved Back less than 22" wide with 1" Quick Release 2 Hole Hardware		CBQR10L2202.....550	E2613 & K0108
Curved Back less than 22" wide with 1" Quick Release 3 Hole Hardware		CBQR10L2203.....550	E2613 & K0108
Curved Back less than 22" wide with 1" Quick Release 5 Hole Hardware		CBQR10L2205.....550	E2613 & K0108
Curved Back less than 22" wide with 1" Quick Release 7 Hole Hardware		CBQR10L2207.....550	E2613 & K0108
Curved Back greater than 22" wide with 1" Quick Release 2 Hole Hardware		CBQR10G2202.....600	E2614 & K0108
Curved Back greater than 22" wide with 1" Quick Release 3 Hole Hardware		CBQR10G2203.....600	E2614 & K0108
Curved Back greater than 22" wide with 1" Quick Release 5 Hole Hardware		CBQR10G2205.....600	E2614 & K0108
Curved Back greater than 22" wide with 1" Quick Release 7 Hole Hardware		CBQR10G2207.....600	E2614 & K0108

HCPCS codes are not to be used as legal or billing advice. Providers are responsible for determining the appropriate codes for Medicare.

I-Modification Back

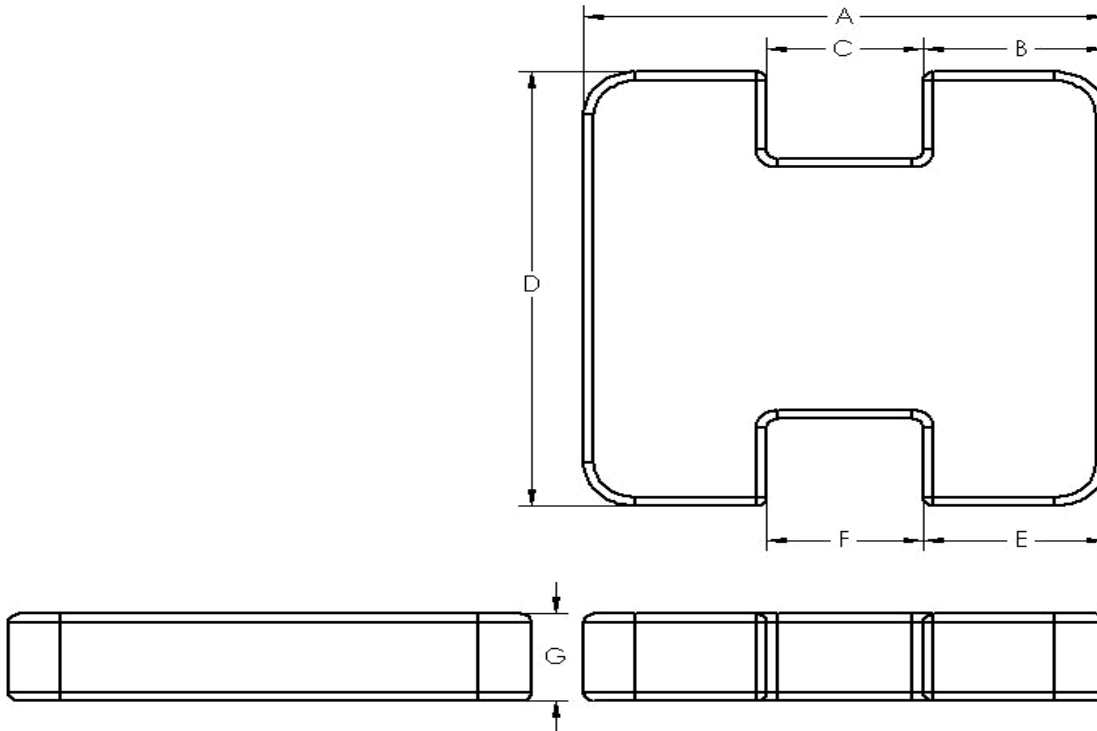

A _____ B _____ C _____ D _____
E _____ F _____ G _____















HCPCS

I-Modification Back less than 22" wide		IMNANAL22NA.....	350	E2613
I-Modification Back greater than 22" wide		IMNANAG22NA.....	400	E2614
I-Modification Back less than 22" wide with 3/4" Fixed 2 Hole Hardware		IMFH34L2202.....	450	E2613 & K0108
I-Modification Back less than 22" wide with 3/4" Fixed 3 Hole Hardware		IMFH34L2203.....	450	E2613 & K0108
I-Modification Back less than 22" wide with 3/4" Fixed 5 Hole Hardware		IMFH34L2205.....	450	E2613 & K0108
I-Modification Back less than 22" wide with 3/4" Fixed 7 Hole Hardware		IMFH34L2207.....	450	E2613 & K0108
I-Modification Back greater than 22" wide with 3/4" Fixed 2 Hole Hardware		IMFH34G2202.....	500	E2614 & K0108
I-Modification Back greater than 22" wide with 3/4" Fixed 3 Hole Hardware		IMFH34G2203.....	500	E2614 & K0108
I-Modification Back greater than 22" wide with 3/4" Fixed 5 Hole Hardware		IMFH34G2205.....	500	E2614 & K0108
I-Modification Back greater than 22" wide with 3/4" Fixed 7 Hole Hardware		IMFH34G2207.....	500	E2614 & K0108
I-Modification Back less than 22" wide with 1" Fixed 2 Hole Hardware		IMFH10L2202.....	450	E2613 & K0108



Backing Order Form

P: (888) 317-9451
F: (888) 216-8796
E: sales@heartmobility.com
HCPCS

I-Modification Back less than 22" wide with 1" Fixed 3 Hole Hardware		IMFH10L2203.....450	E2613 & K0108
I-Modification Back less than 22" wide with 1" Fixed 5 Hole Hardware		IMFH10L2205.....450	E2613 & K0108
I-Modification Back less than 22" wide with 1" Fixed 7 Hole Hardware		IMFH10L2207.....450	E2613 & K0108
I-Modification Back greater than 22" wide with 1" Fixed 2 Hole Hardware		IMFH10G2202.....500	E2614 & K0108
I-Modification Back greater than 22" wide with 1" Fixed 3 Hole Hardware		IMFH10G2203.....500	E2614 & K0108
I-Modification Back greater than 22" wide with 1" Fixed 5 Hole Hardware		IMFH10G2205.....500	E2614 & K0108
I-Modification Back greater than 22" wide with 1" Fixed 7 Hole Hardware		IMFH10G2207.....500	E2614 & K0108
I-Modification Back less than 22" wide with 3/4" Quick Release 2 Hole Hardware		IMQR34L2202.....550	E2613 & K0108
I-Modification Back less than 22" wide with 3/4" Quick Release 3 Hole Hardware		IMQR34L2203.....550	E2613 & K0108
I-Modification Back less than 22" wide with 3/4" Quick Release 5 Hole Hardware		IMQR34L2205.....550	E2613 & K0108
I-Modification Back less than 22" wide with 3/4" Quick Release 7 Hole Hardware		IMQR34L2207.....550	E2613 & K0108
I-Modification Back greater than 22" wide with 3/4" Quick Release 2 Hole Hardware		IMQR34G2202....600	E2614 & K0108
I-Modification Back greater than 22" wide with 3/4" Quick Release 3 Hole Hardware		IMQR34G2203....600	E2614 & K0108
I-Modification Back greater than 22" wide with 3/4" Quick Release 5 Hole Hardware		IMQR34G2205....600	E2614 & K0108
I-Modification Back greater than 22" wide with 3/4" Quick Release 7 Hole Hardware		IMQR34G2207....600	E2614 & K0108
I-Modification Back less than 22" wide with 1" Quick Release 2 Hole Hardware		IMQR10L2202....550	E2613 & K0108
I-Modification Back less than 22" wide with 1" Quick Release 3 Hole Hardware		IMQR10L2203....550	E2613 & K0108
I-Modification Back less than 22" wide with 1" Quick Release 5 Hole Hardware		IMQR10L2205....550	E2613 & K0108
I-Modification Back less than 22" wide with 1" Quick Release 7 Hole Hardware		IMQR10L2207....550	E2613 & K0108
I-Modification Back greater than 22" wide with 1" Quick Release 2 Hole Hardware		IMQR10G2202....600	E2614 & K0108
I-Modification Back greater than 22" wide with 1" Quick Release 3 Hole Hardware		IMQR10G2203...600	E2614 & K0108
I-Modification Back greater than 22" wide with 1" Quick Release 5 Hole Hardware		IMQR10G2205...600	E2614 & K0108
I-Modification Back greater than 22" wide with 1" Quick Release 7 Hole Hardware		IMQR10G2207...600	E2614 & K0108

HCPCS codes are not to be used as legal or billing advice. Providers are responsible for determining the appropriate codes for Medicare.

Bi-Angular Back

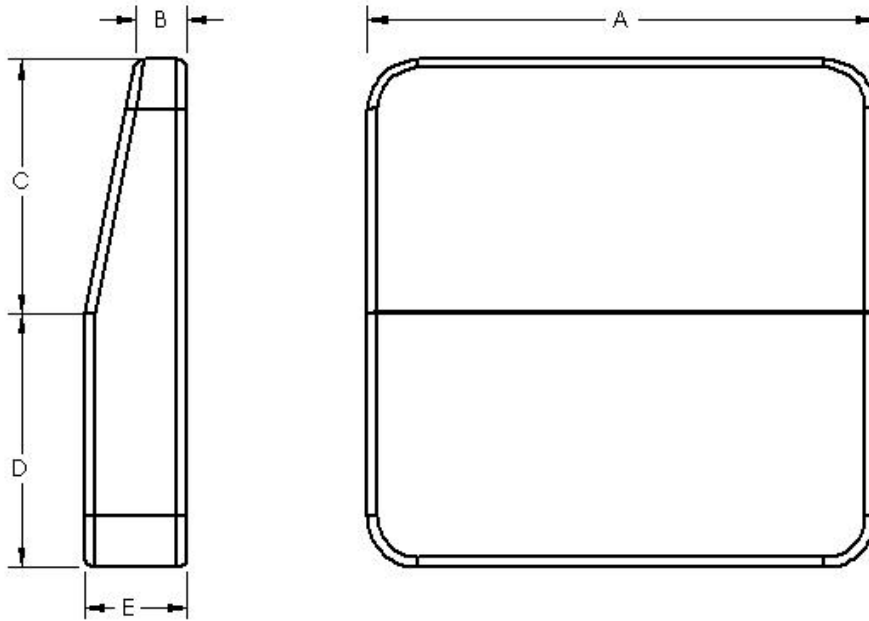

HCPCS

Bi-Angular Back less than 22" wide	BANANAL22NA	350	E2613
Bi-Angular Back greater than 22" wide	BANANAG22NA	400	E2614
Bi-Angular Back less than 22" wide with 3/4" Fixed 2 Hole Hardware	BAFH34L2202	450	E2613 & K0108
Bi-Angular Back less than 22" wide with 3/4" Fixed 3 Hole Hardware	BAFH34L2203	450	E2613 & K0108
Bi-Angular Back less than 22" wide with 3/4" Fixed 5 Hole Hardware	BAFH34L2205	450	E2613 & K0108
Bi-Angular Back less than 22" wide with 3/4" Fixed 7 Hole Hardware	BAFH34L2207	450	E2613 & K0108
Bi-Angular Back greater than 22" wide with 3/4" Fixed 2 Hole Hardware	BAFH34G2202	500	E2614 & K0108
Bi-Angular Back greater than 22" wide with 3/4" Fixed 3 Hole Hardware	BAFH34G2203	500	E2614 & K0108
Bi-Angular Back greater than 22" wide with 3/4" Fixed 5 Hole Hardware	BAFH34G2205	500	E2614 & K0108
Bi-Angular Back greater than 22" wide with 3/4" Fixed 7 Hole Hardware	BAFH34G2207	500	E2614 & K0108
Bi-Angular Back less than 22" wide with 1" Fixed 2 Hole Hardware	BAFH10L2202	450	E2613 & K0108
Bi-Angular Back less than 22" wide with 1" Fixed 3 Hole Hardware	BAFH10L2203	450	E2613 & K0108
Bi-Angular Back less than 22" wide with 1" Fixed 5 Hole Hardware	BAFH10L2205	450	E2613 & K0108

HCPCS codes are not to be used as legal or billing advice. Providers are responsible for determining the appropriate codes for Medicare.



Backing Order Form

P: (888) 317-9451
F: (888) 216-8796
E: sales@heartmobility.com
HCPCS

Bi-Angular Back less than 22" wide with 1" Fixed 7 Hole Hardware		BAFH10L2207.....450	E2613 & K0108
Bi-Angular Back greater than 22" wide with 1" Fixed 2 Hole Hardware		BAFH10G2202.....500	E2614 & K0108
Bi-Angular Back greater than 22" wide with 1" Fixed 3 Hole Hardware		BAFH10G2203.....500	E2614 & K0108
Bi-Angular Back greater than 22" wide with 1" Fixed 5 Hole Hardware		BAFH10G2205.....500	E2614 & K0108
Bi-Angular Back greater than 22" wide with 1" Fixed 7 Hole Hardware		BAFH10G2207.....500	E2614 & K0108
Bi-Angular Back less than 22" wide with 3/4" Quick Release 2 Hole Hardware		BAQR34L2202.....550	E2613 & K0108
Bi-Angular Back less than 22" wide with 3/4" Quick Release 3 Hole Hardware		BAQR34L2203.....550	E2613 & K0108
Bi-Angular Back less than 22" wide with 3/4" Quick Release 5 Hole Hardware		BAQR34L2205.....550	E2613 & K0108
Bi-Angular Back less than 22" wide with 3/4" Quick Release 7 Hole Hardware		BAQR34L2207.....550	E2613 & K0108
Bi-Angular Back greater than 22" wide with 3/4" Quick Release 2 Hole Hardware		BAQR34G2202....600	E2614 & K0108
Bi-Angular Back greater than 22" wide with 3/4" Quick Release 3 Hole Hardware		BAQR34G2203....600	E2614 & K0108
Bi-Angular Back greater than 22" wide with 3/4" Quick Release 5 Hole Hardware		BAQR34G2205....600	E2614 & K0108
Bi-Angular Back greater than 22" wide with 3/4" Quick Release 7 Hole Hardware		BAQR34G2207....600	E2614 & K0108
Bi-Angular Back less than 22" wide with 1" Quick Release 2 Hole Hardware		BAQR10L2202....550	E2613 & K0108
Bi-Angular Back less than 22" wide with 1" Quick Release 3 Hole Hardware		BAQR10L2203.....550	E2613 & K0108
Bi-Angular Back less than 22" wide with 1" Quick Release 5 Hole Hardware		BAQR10L2205.....550	E2613 & K0108
Bi-Angular Back less than 22" wide with 1" Quick Release 7 Hole Hardware		BAQR10L2207.....550	E2613 & K0108
Bi-Angular Back greater than 22" wide with 1" Quick Release 2 Hole Hardware		BAQR10G2202....600	E2614 & K0108
Bi-Angular Back greater than 22" wide with 1" Quick Release 3 Hole Hardware		BAQR10G2203...600	E2614 & K0108
Bi-Angular Back greater than 22" wide with 1" Quick Release 5 Hole Hardware		BAQR10G2205...600	E2614 & K0108
Bi-Angular Back greater than 22" wide with 1" Quick Release 7 Hole Hardware		BAQR10G2207...600	E2614 & K0108