

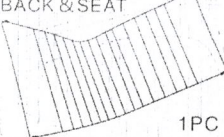

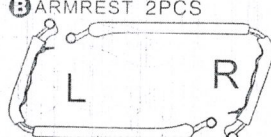

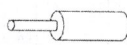



Instruction Manual 906

parts list

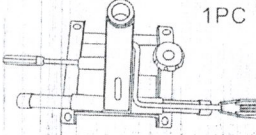
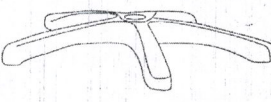
A BACK & SEAT  1PC	B ARMREST 2PCS  L R	C GASLIFT 1PC  1PC	D WHEELS 5PCS  5PCS	E WASHER  4 PCS	F SCREW  SHORT 4 PCS
G MECHANISM  1PC	H LEG  1PC	I LEG COVER 1PC  1PC	J CAP  4 PCS	K SCREW  LONG 4 PCS	L TOOL  Allen key

Installation steps

1 Pressing the wheels into the leg.

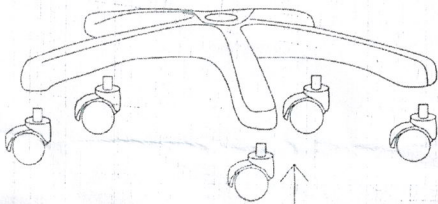

2 Put the leg cover and gaslift.

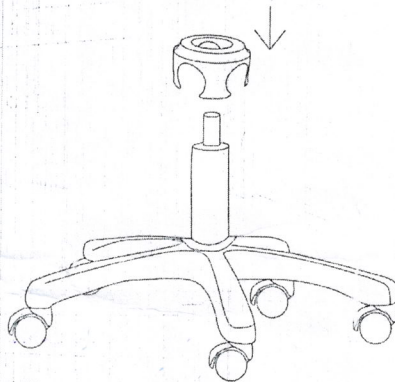

3 Use 4pcs short screw install the mechanism on the seat.

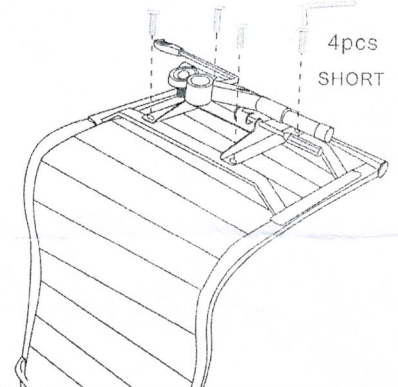

4 Use 4pcs long screw connect armrests to the back & seat.

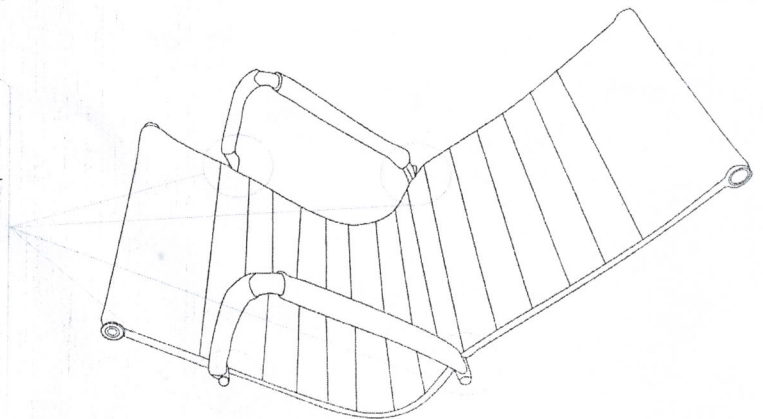
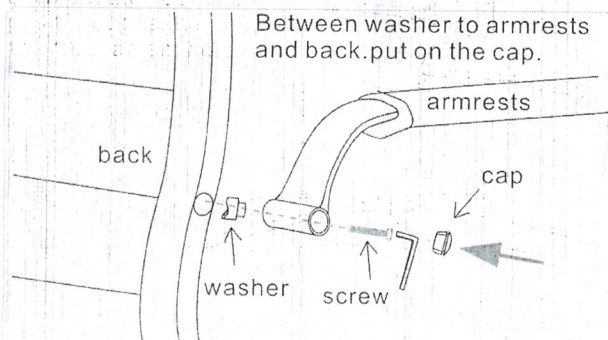

5

Connect the seat and gaslift, put gaslift into the mechanism hole.

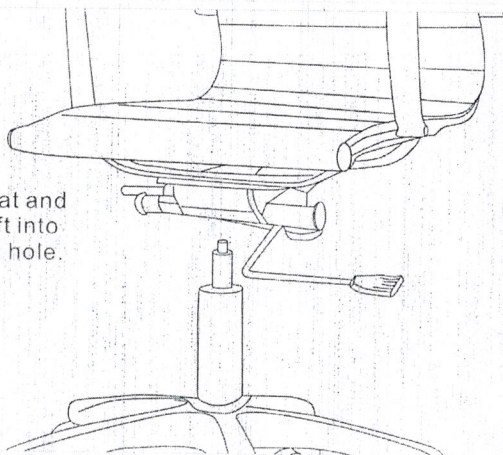

6 finish

