

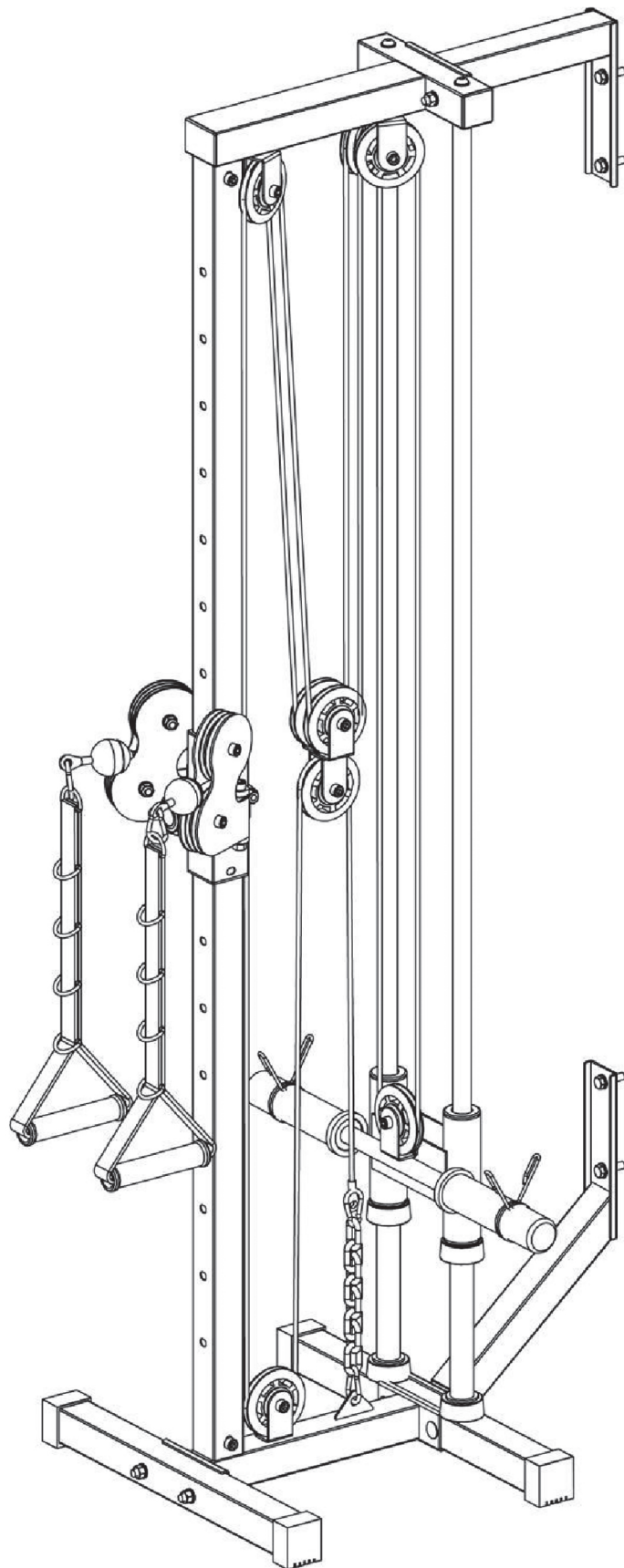









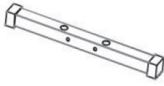
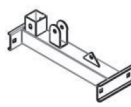





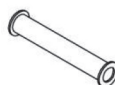

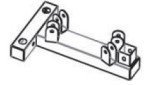





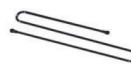





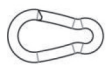

SYNERGEE

Wall Mounted Pulley Machine - Installation Manual

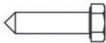

SYNERGEE

Wall Mounted Pulley Machine - Parts List

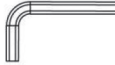
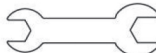
1. Rear stabilizer (1 pcs) 	2. Main stabilizer (1 pcs) 	3. Wall stabilizer (1 pcs) 	4. Front Stabilizer (1 pcs) 	5. Main frame (1 pcs) 
6. Frame Cover (1 pcs) 	7. Rubber Stopper (4 pcs) 	8. Weight Stack Support (2 pcs) 	9. Weight Stack Bar (1 pcs) 	10. Slider Bar (2 pcs) 
11. Upper Frame (1 pcs) 	12. Upper Frame Connector (1 pcs) 	13. Pulley Container (2 pcs) 	14. Pulley Bracket (1 pcs) 	15. Pulley (13 pcs) 
16. Cable A (1 pcs) (344.4") 	17. Cable B (1 pcs) (107.4") 	18. Chain (1 pcs) 	19. Sleeve (2 pcs) 	20. 2" Spring Collar (2 pcs) 
21. 1" Spring Collar (2 pcs) 	22. Handle (2 pcs) 	23. Carabiner (4 pcs) 		
24. M10x65 (6 pcs) 	25. M10x90 (2 pcs) 	26. M10x80 (1 pcs) 	27. M10x60 (2 pcs) 	28. M10x45 (11 pcs) 
29. M10x20 (5 pcs) 	30. M8x90 (4 pcs) 	31. M10x60 (4 pcs) 	32. Washers Ø11 (28 pcs) 	33. M10 Nuts (23 pcs) 
34. #6 Allen Key (1 pcs) 	35. #8 Allen Key (1 pcs) 	36. 14mm 17mm Wrench (1 pcs) 		

SYNERGEE

Wall Mounted Pulley Machine - Installation Manual

STEP 1:

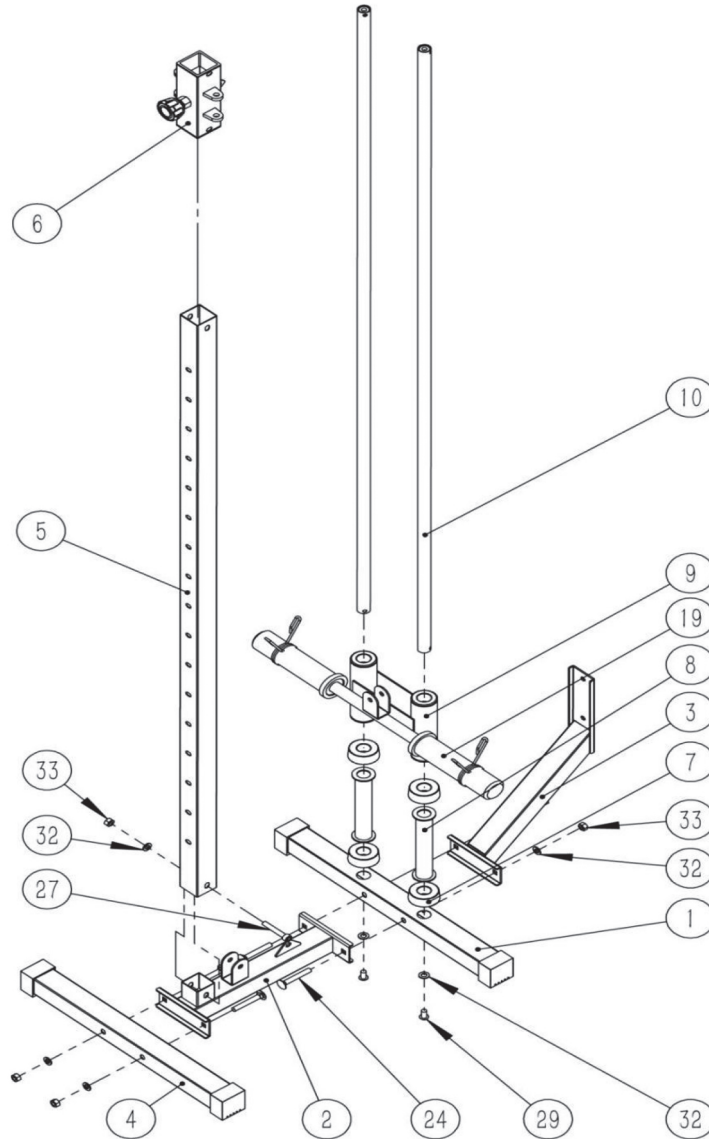

Connect the **rear stabilizer(#1)**, **main stabilizer(#2)**, **wall stabilizer(#3)** using 2 x **m10x65(#24)**, 2 x **washers Ø11(#32)**, 2 x **M10 Nuts(#33)**. Lightly tighten temporarily.

Connect the **front stabilizer(#4)** using 2 x **m10x65(#24)**, 2 x **washers Ø11(#32)**, 2 x **M10 Nuts(#33)**.

Insert the **main frame(#5)** into the **main stabilizer(#2)** using 1 x **m10x60(#27)**, 1 x **washer Ø11(#32)** and 1 x **M10 Nut(#33)**.

Slide the **frame cover(#6)** over top of the **main frame(#5)**.

Slide the 2 **slide bars(#10)** through the **main frame(#5)**. Insert through slide bars 4 x **rubber stoppers(#7)**, 2 x **weight stack supports(#8)** and 1 x **weight stack bar(#9)** as shown in picture. Secure with 2 x **m10x20(#29)** and 2 x **washers Ø11(#32)**.

Optionally you can install the 2" **sleeves(#19)** and use the 2" **spring collars(#20)**.

SYNERGEE

Wall Mounted Pulley Machine - Installation Manual

STEP 2:

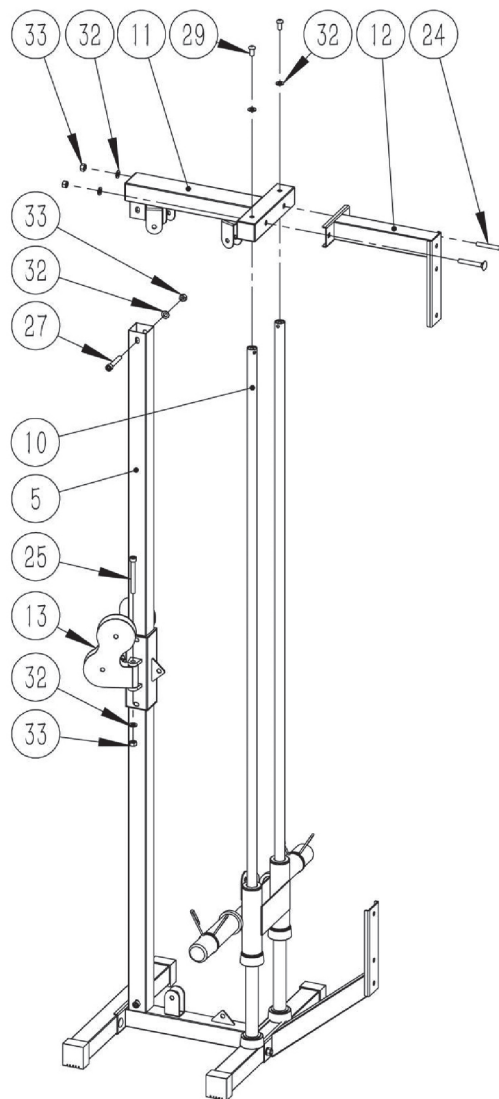

Connect the 2 **pulley containers**(#13) to the **frame cover**(#6) using 2 x **m10x90**(#25), 2 x **washers** Ø11(#32) and 2 x **M10 Nuts**(#33) as shown.

Insert the **upper frame**(#11) and attach using 1 x **m10x60**(#27), 1 x **washer** Ø11(#32) and 1 x **M10 Nut**(#33) as shown. Lightly tighten temporarily.

Attach the **upper frame**(#11) to the **slide bars**(#10) using 2 x **m10x20**(#29) and 2 x **washers** Ø11(#32). Lightly tighten temporarily.

Attach the **upper frame connector**(#12) using 2 x **m10x65**(#24), 2 x **washers** Ø11(#32) and 2 x **M10 Nuts**(#33).

Tighten all nuts from step 2.

SYNERGEE

Wall Mounted Pulley Machine - Installation Manual

STEP 3:

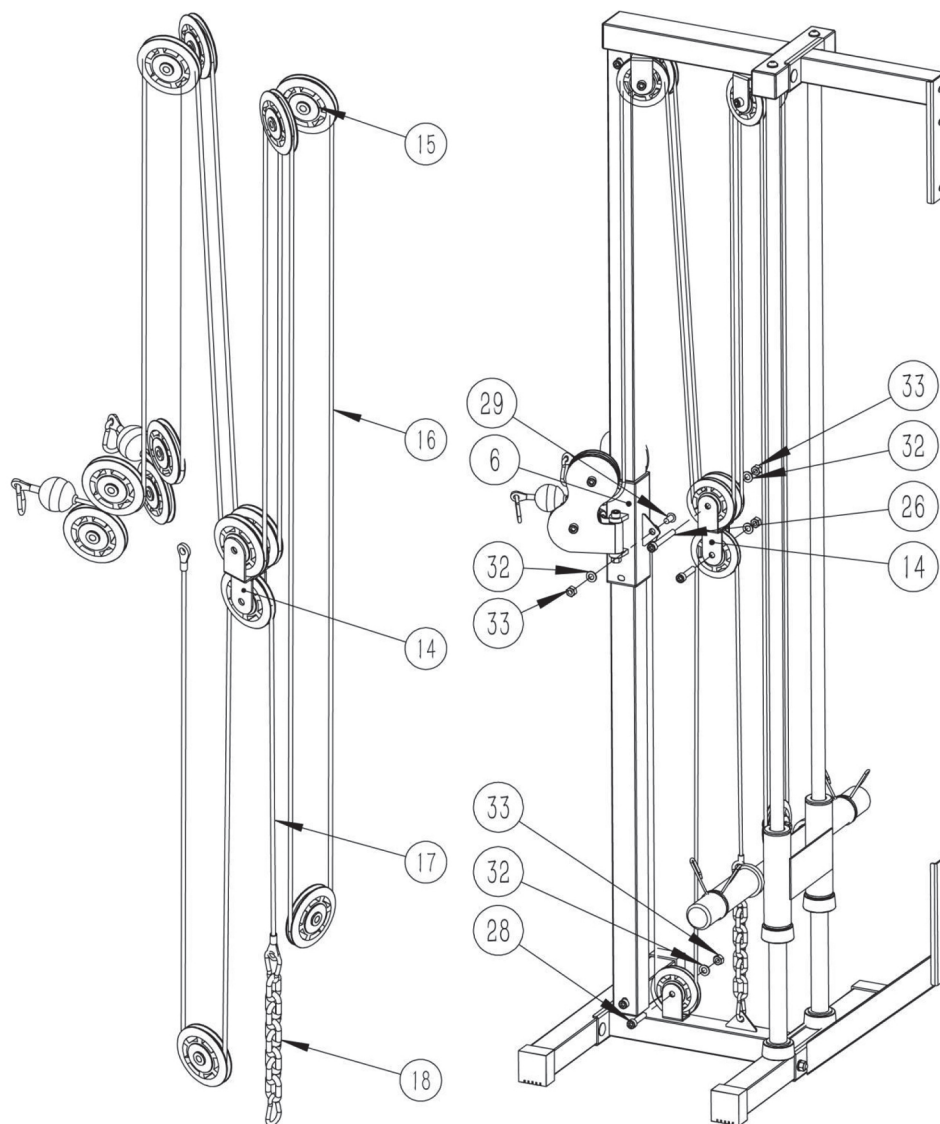

Set up the **pulleys(#15)** with **cable A(#16)** and **cable B(#17)** as shown in the image on the left.

Use image for reference: Feed **cable A(#16)** through **pulley(#15)**, attach pulley to the **pulley container(#13)** with 1 x **m10x45(#28)**, 1 x **washer Ø11(#32)**, 1 x **M10 Nut(#33)** per side.

Attach 2 **pulleys(#15)** to the top of the **pulley bracket(#14)** with 1 x **m10x80(#26)**, 1 x **washer Ø11(#32)** and 1 x **M10 Nut(#33)**.

Attach 4 x **pulleys(#15)** to the **upper frame(#11)** with 4 x **m10x45(#28)**, 4 x **washer Ø11(#32)**, 4 x **M10 Nut(#33)**.

Feed **cable B(#17)** as shown. For each **pulley(#15)** attach using 1 x **m10x45(#28)**, 1 x **washer Ø11(#32)** and 1 x **M10 Nut(#33)**.

Attach **cable B(#17)** to the **frame cover(#6)** using 1 x **m10x20(#29)**, 1 x **washer Ø11(#32)** and 1 x **M10 Nut(#33)**. Use the **chain(#18)** to attach **cable B(#17)** to the **main stabilizer(#2)**.

SYNERGEE

Wall Mounted Pulley Machine - Installation Manual

STEP 4:

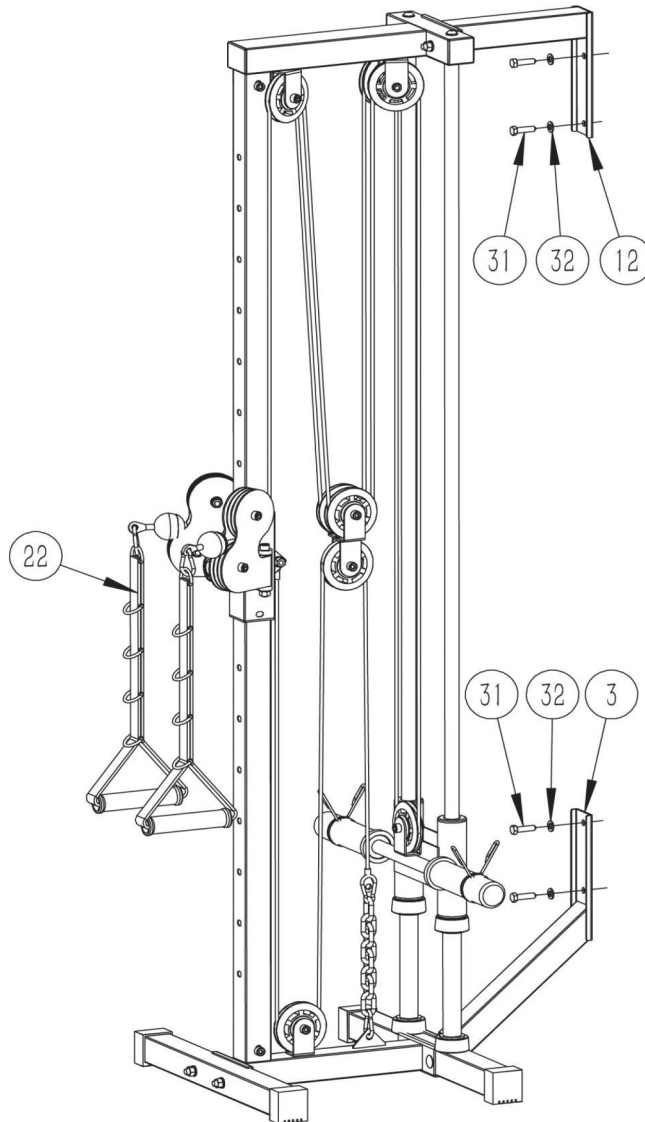

Attach the 2 **handles**(#22) to the cable with a **crabiner**(#23).

Attach the entire rack to the wall using either 4 x **m10x60**(#31) or 4 x **m8x90**(#30), 2 x **washer Ø11**(#32).

WARNING

WARNING: SERIOUS INJURY OR DEATH CAN OCCUR IF CAUTION IS NOT USED.

As with any workout equipment that involves heavy weights, there is a risk of injury when using the Synergee Wall mounted Pulley Machine. The best way to reduce the risk of serious injury is to exercise caution. Follow the instructions in this manual and familiarize yourself with all warnings on your product before using it.

Before beginning any exercise program, consult your physician. This is especially important for persons over age 35 or persons with pre-existing health issues.

Follow these precautions to ensure you use your Synergee Pulley Machine safely:

- 1.** Read all instructions in this manual and all warnings on the product before using it. It is the responsibility of the owner to ensure that all users of this product are adequately informed of all the safety precautions.
- 2.** Use this product only as described in this manual and keep this manual handy for future reference.
- 3.** Always keep children and pets away from this product. Keep hands and feet away from moving parts.
- 4.** This product is intended for consumer use only in an indoor environment. Do not use it in a commercial, rental, or institutional setting. Keep this product indoors, away from moisture and dust.
- 5.** Place the product on a level surface, with at least 3 feet of clearance around it. To protect the floor or carpet from damage, place a mat under it.
- 6.** Install the Pulley System properly and according to instructions. Properly tighten all parts and check their tightness regularly. If any worn or damaged parts are found, stop usage immediately. Refrain from use until the machine has been repaired.
- 7.** Make sure all locking mechanisms are properly secured before using the unit. Ensure adjustment pins function properly and they are fully engaged before placing any weight.
- 8.** Wear appropriate clothes while exercising. Do not wear loose clothes that can get caught and always wear athletic shoes while exercising.
- 9.** Do not install any fitness product near a pool, hot tub or other damp locations. Corrosion caused by installation in these locations can lead to premature failure of components, which is not covered under any warranty.
- 10.** Do not use this rack to exhaustion: stop exercising and step away from the rack if you feel faint, dizzy, or in pain.
- 11.** To avoid damaging parts, do not use power tools for assembly. Use hand tools and the hardware provided.

**IF ANY PIECES ARE MISSING, PLEASE CONTACT US IMMEDIATELY:
CUSTOMERCARE@IHEARTSYNERGEE.COM OR 1.855.217.7136**