

# Gerni

Why compromise

Classic 100.3  
Classic 100.3 S  
Classic 110.4  
Classic 115.3  
Classic 120.4

---



User Guide



Classic 100.3  
Classic 100.3 S  
Classic 110.4  
Classic 115.3  
Classic 120.4



# Contents

1	Introduction .....	3
2	Safety precautions and working techniques .....	3
3	Before you start using your high pressure washer .....	7
4	Operating your high pressure washer .....	8
5	After using the pressure washer .....	9
6	Maintenance .....	10
7	Troubleshooting .....	10
8	Warranty Conditions .....	11
9	Main technical Data .....	12
10	Declaration of Conformity .....	13

## 1 Introduction

### 1.1 Symbols used to mark instruction

All pictograms attached to the high pressure washer and its components are shown and explained in this manual.



Safety instructions marked with this symbol must be observed to prevent personal injury or serious damage to property.



Caution where there is a risk of damaging the machine or its individual components.



This symbol indicates tips and instructions to simplify work and to ensure a safe operation of the high pressure washer.

## 2 Safety precautions and working techniques



Before starting up your machine for the first time, this instruction manual must be read through carefully. Save the instructions for later use.

### WARNING !



- Inhalation of aerosols can be hazardous to health.
- Where applicable use a device in order to avoid or reduce aerosols production, e.g., a shield covering the nozzle.
- For protection against aerosols use a respiratory mask of class FFP 2 or higher.
- The high water pressure generated by the machine and the power connection are particular sources of danger.
- Do not let people who have not been trained in the use of a machine nor read the instruction manual operate the machine.
- Minors should never be allowed to use the machine - except for young trainees over the age of 16, when working under supervision.
- Before starting up your machine please check it carefully for any defects. If you find any, do not start up your machine, contact your Gerni distributor. The insulation of the electric cable should be faultless and without any cracks. If the electric cable is damaged, an authorized Gerni distributor should replace it.
- The operator and anyone in the immediate vicinity of the site of cleaning should take action to protect themselves from being struck by debris dislodged during operation.
- Always unplug the power plug before cleaning or maintenance and when replacing parts or converting the machine to another function.
- Observe the national safety regulations issued, for example, by the employers liability

insurance association, social security institutions, occupational safety and health authorities or other organizations.



### Accessories and spare parts

- To ensure the machine safety only use original spare parts from Gerni or approved by Gerni.
- High pressure hoses, fittings and couplings are important for the safety of the machine. Only use hoses, fittings and couplings recommended by Gerni.



### Physical, sensory or mental conditions

- The machine may only be operated by people who are in good physical health and in good mental condition.
- If you have any condition that might be aggravated by strenuous work, check with your doctor before operating the machine.
- Anyone who has consumed alcohol, medicines or drugs affecting their ability to react must not operate the machine.



### Applications

This machine has been developed for domestic use such as:

- Car, motorbike, boat, caravan, trailer, patio/drive/flagstones, woodwork, brickwork, barbecue, garden furniture, lawn mower.

Any other use is considered as improper use. Gerni accepts no liability for any damage resulting from such use. The risk for such use is borne solely by the user. Proper use also includes proper operation, servicing and repairs as specified in this instruction.

### Clothing and equipment

Always take action to protect yourself when operating the machine.

- Wear shoes with non-slip soles.
- Wear goggles, ear protection and protective clothes during operation.



### Transporting the high pressure washer

- When transporting the machine in or on a vehicle, it must be secured, e.g. with straps, so that it cannot slip or tip over.
- Gerni recommends that the machine is positioned horizontally on the backside, when transported in or on a vehicle.



### Detergents

- This machine has been designed for use with cleaning agents supplied or recommended by Gerni. The use of other cleaning agents or chemicals may adversely affect the function of the machine.



### Before starting the work Inspecting the machine

- Do not use the machine if a supply cord or important parts of the machine are damaged, e.g., safety device, high pressure hose, and spray handle and spray attachments.
- The trigger of the spray handle must move easily and automatically return to its starting position when released.
- Always keep high pressure hose and spray attachment in good condition (clean, moving easily) and correctly assembled.



### Electrical connection

## WARNING !

Minimize the risk for electrical shock:

- Voltage and frequency of the machine (see rating plate) must match the voltage of and frequency of the mains supply.
- Only connect the machine to electrical installation made by a certified electrician and comply with IEC 60364-1.
- It is recommended that the electrical supply to the machine should include a residual current device that will interrupt the supply if the leakage current to earth exceeds 30 mA for 30 ms.
- Inadequate extension cables can be dangerous. If an extension cable is used, it shall be

suitable for outdoor use, and the connection has to be kept dry and off the ground.

- Gerni recommends use of an extension cable drum when cable extension is needed which keeps the socket at least 60 mm above the ground.
- Cables on extension cable drums should always be completely unwound to prevent overheating. Extension cables must comply with the below-mentioned requirements for length and cable dimensions:

1.0 mm <sup>2</sup>	Max.	12.5 m
1.5 mm <sup>2</sup>	Max.	20.0 m
2.5 mm <sup>2</sup>	Max.	30.0 m

- If the electric cable is damaged, it must be replaced by an authorized Gerni distributor or similar qualified person in order to avoid a hazard.

### Water connection

- Connection of the machine to the drinking water mains according to national regulations.
- Operation by suction (e.g. a rainwater vessel) – see “**Connecting to a pressureless water supply**”. The machine can be connected to water mains with a max. inlet pressure of 1 MPa/10 bars and max. 40°C.
- An ordinary ½" garden hose of min. 10 m and max. 25 m will be suitable for normal operation at 3 bar inlet pressure.



### IMPORTANT !

- Only use water without any impurities.
- If there is a risk of running sands in the inlet water (i.e. from your own well), an additional filter should be mounted.



### During work

### WARNING !

- Never use the machine in an environment where there could be a danger of explosions. If any doubt arises contact the local authorities.
- It is not allowed to clean asbestos-containing surfaces with high pressure.
- Never draw in fluids containing solvents (e.g., gasoline, heating oil, paint thinner or acetone) These substances damage the materials used in the machine. Their spray is highly combustible, explosive and poisonous.
- Never direct the water jet at yourself, other persons, not even to clean clothing or footwear - **risk of injury**.
- Never direct the water jet at pets or other animals.
- Never direct the water jet at live electrical equipment or the machine itself - **danger of short-circuiting**.
- Hold the spray lance firmly with both hands. The spray lance is affected by a thrust of up to 16.4 N during operation.
- This high pressure washer machine must not be operated at temperatures below 0°C.
- Never start up a frozen machine. Frost damages are not covered by the guarantee!
- Always ensure firm and safe footing.
- Keep the machine as far away as possible from the object being cleaned.
- Always adjust the distance and thus the pressure of the nozzle to the surface, which is to be cleaned to avoid any damage to the surface being cleaned.
- The machine shall be operated in an upright position.
- Do not cover the machine or use it in a room without adequate ventilation.



### After finishing the work

### WARNING !

- Always switch off the machine and unplug the power plug from the socket after work and when leaving the machine unattended.
- Disconnect water inlet hose between machine and water supply.
- Wind up electrical cable and high pressure hose – to avoid damage of cable, plug, high pressure hose and fittings.

- Always empty pump, hose and accessories of water after use of the machine and prior to storing.



## Maintenance and repairs

### WARNING !

- Always disconnect the electrical plug from the socket prior to maintenance, cleaning and repair.
- Any repair should always be made in Gerni authorized workshop with original Gerni spare parts.
- Do not attempt any maintenance not described in the instructions.
- If the machine refuses to start, stops, pulsates, pressure fluctuates, motor busses, fuse blows or no water comes out, check the trouble shooting diagram in these instructions. In case other problems occur, please contact your local Gerni distributor.



### Recycling the high pressure washer

Make the old machine unusable immediately.

- Unplug the machine.
- Cut the electric cable.

Do not discard electrical appliances with household waste. As specified in European Directive 2002/96/EC on old electrical and electronic appliances, used electrical goods must be collected separately and recycled ecologically. Contact your local authorities or your nearest dealer for further information.

## 3 Before you start using your high pressure washer



See the pictorial quick reference guide – unpacking.  
Illustration shows the operation elements and how to prepare your machine for use.

### Operation elements

1. Start/stop switch
2. Water inlet with filter (2a)
3. High pressure connection
4. High pressure hose
5. Electric cable
6. Click&Clean spray lance
7. Spray handle with lock (7a)
8. Click&Clean Tornado nozzle (Classic 100.3, Classic 110.4, Classic 115.3)
9. Click&Clean Tornado PR nozzle (C 120.4)
10. Click&Clean Powerspeed nozzle
11. Foam sprayer
12. Nozzle cleaning tool
13. Accessory storage
14. Model tag
15. Trolley handle
16. Holder for hose/electric cable (Classic 100.3 S, Classic 110.4, Classic 115.3, Classic 120.4)
17. Hexagon key for handle and bracket mounting
18. Wheel brackets
19. Wheels
20. Wheel caps

### 3.1 Mounting of trolley handle and wheels

#### Mounting of trolley handle

Only applicable for models with trolley handle (Classic 100.3 S, Classic 110.4, Classic 115.3, Classic 120.4)

- A1** Place the trolley handle (15) on the machine.
- A2** Secure the handle by mounting the 2 screws using the enclosed hexagon key (17).

#### Mounting of wheel brackets

Only applicable for models with wheels (Classic 110.4, Classic 115.3, Classic 120.4)

- A3** Place the wheel brackets (18) on the machine.
- A4** Secure the wheel brackets by mounting the 2 screws, using the enclosed hexagon key.
- A5** Place the wheels (19) on the wheel axle – push into position – you should hear a click when the wheels are in correct position.
- A6** Secure the wheels by mounting the wheel caps (20) – you should hear a click when the wheel caps are in correct position and the wheel is secured.

### 3.2 Mounting of quick coupling

- A7** When mounting the quick coupling for the first time, check that the factory fitted filter (2a) is positioned in the water inlet pipe.
- A8** Screw the quick coupling tight on to the water inlet (2).



#### IMPORTANT!

The inlet filter must always be fitted in the water inlet pipe to filter out sand, limestone and other impurities as these will damage the pump valves. The filter is factory fitted. Failure to fit the filter will invalidate the guarantee.

## 4 Operating your high pressure washer



See the pictorial quick reference guide – operating your high pressure washer.

### 4.1 Connection of high pressure hose

- B1** Attach the high pressure hose (4) to the spray handle (7). Detach the high pressure hose by pressing the button (A).
- B2** Mount the high pressure hose on the outlet (3).

### 4.2 Mounting of spray lance and Click&Clean nozzles

- B3** Push the spray lance (6) into the spray handle, twist and release.



#### NOTE!

The spray lance has a built-in low pressure nozzle that can be used for flushing away dirt.

- B4** When attaching the nozzles (8, 9, 10), press the nozzles into the spray lance.



#### IMPORTANT!

When attaching the click & Clean nozzles, the button on the side of the spray lance should come out again. The nozzle should stay in position when pulling it.

- B5** Push the foam sprayer (11) into the spray lance.



#### NOTE!

The foam sprayer features a swivel lock, which must be positioned in the hole in the Click & Clean spray lance. Press the button to detach the Click & clean nozzles and the foam sprayer.



#### IMPORTANT!

Before starting the cleaning job, check that the machine is in an upright position and placed on an even surface. Do not place the machine in long grass!

### 4.3 Water Connection



#### IMPORTANT!

#### Connecting to pressurized water supply

The inlet water max. pressure is 1 MPa/10 bar and the max. temperature is 40°C – see rating plate. An ordinary ½" garden hose of min. 10 m and max. 25 m will be suitable.

- B6** Check that the filter is fitted in the water inlet pipe and that it is not clogged up.
- B7** Connect the water hose to the water supply by means of the quick connector. Turn on the water.

Connection to the drinking water mains according to national and local regulations.



Let the water run through the water hose before connecting it to the machine to prevent sand and dirt from penetrating the machine.

- B8** Turn off the water and connect the water hose by means of the quick coupling to the water inlet.



#### Connecting to pressure less water supply

The machine can also operate in suction mode, meaning that you can connect the machine to e.g. rainwater vessels, rivers, lakes and cisterns etc.

When connecting the machine to operate from pressure less water supplies – always use ad-





ditional filtering to secure that impurities are not sucked in. Hose length should be max. 3 meter and of minimum ½".

To meet these requirements, Gerni recommends that you use the original Gerni suction hose kit.

The Machine is designed for suction up to 50 cm above the water surface.

- Position the machine at max. 0.5 meter above water surface. Detach the high pressure hose from the outlet.
- Ensure that the inlet filter is in position and attach the suction hose kit, secure tight connection to the inlet.
- Turn on the machine, pressing the start/stop switch (1) into position "I".
- Wait until a steady jet exits the outlet.
- Switch off the machine and attach high pressure hose (4), spray handle, lance and nozzle.
- Start the machine again and activate the spray handle.

#### 4.4 Starting the high pressure washer



##### IMPORTANT!

##### Connecting to mains power supply

The voltage and frequency of the machine (see model tag (14)) must match the voltage and frequency of the power supply.

**B9** Insert the power plug into power supply socket.

**B10** Turn on the water.

**B11** Release the trigger lock (7a). Remember to unplug, turn off the high pressure washer and lock the trigger, when leaving the high pressure washer unattended

**B12** Activate the trigger of the spray handle and let the water run until all air has escaped from the water hose.

**B13** Turn on the machine, pressing the start/stop switch into position "I".

**B14** Activate the trigger of the spray handle. When releasing the trigger of the spray handle, the machine automatically stops. The machine will start again when you reactivate the trigger of the spray handle.



## 5 After using the pressure washer

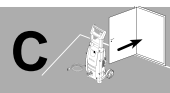

See the pictorial quick reference guide – storing the high pressure washer.



The high pressure washer should be stored in a frost free room! Should the machine by a mistake be frozen, it will be necessary to check it for damages.

### 5.1 Stopping the high pressure washer

**C1** Shut off the water supply and activate the trigger of the spray handle and let the machine run until no more water runs out of the nozzle. This will wash out water hose, high pressure hose, spray lance and nozzles.

**C2** Stop the machine, pressing the start/stop switch into position "0".

**C3** Unplug the machine from the power supply socket and wind up the electrical cable (5) and place it on the holder (16).

**C4** Rinse the spray lance, nozzles and the foam sprayer after use.

**C5** Place spray handle, lance, nozzles, foam sprayer and other accessories in the holders on the high pressure washer.

## 6 Maintenance



See the pictorial quick reference guide - maintenance.



To ensure a long and problem free working life of the high pressure washer, please take the following advices:

- Wash out water hose, high pressure hose, spray lance and accessory before mounting
- Clean the connectors of dust and sand
- Rinse the detergent bottle and the detergent nozzle
- Clean the nozzle
- Keep the water inlet filter clean and unclogged

### Cleaning of the water inlet filter

**D1** Clean the water inlet filter regularly once a month or more frequently according to use. Carefully loosen the filter with a screwdriver and clean it. Check that it is intact before remounting it.

### Cleaning of nozzle

A clogging up in the nozzle causes a pump pressure which is too high, why cleaning is required immediately.



#### IMPORTANT!

The nozzle cleaning tool (12) should only be used when the nozzle is detached and the machine is stopped!

**D2** Stop the machine and disconnect the nozzle. Clean the nozzle.

**D3** Flush the nozzle backwards with water.

### Cleaning of machine vents

**D4** The machine should be kept clean so as to let cooling air pass freely through the machine vents.

### Greasing of O-rings

**D5** To ensure an easy connection and that O-rings do not dry up the couplings should be greased regularly.

## 7 Troubleshooting

To avoid unnecessary disappointments, you should check the following before contacting the Gerni service organization.

Symptom	Cause	Recommended action
<b>Machine refuses to start</b>	Machine not plugged in Defective socket Fuse has blown Defective extension cable	Plug in machine Try another socket. Replace fuse. Switch off other machines. Try without the extension cable.
<b>Fluctuating pressure</b>	Pump sucking air Valves dirty, worn out or stuck Pump seals worn out	Check that hoses and connections are airtight. Contact your local Gerni Service centre. Clean and replace or refer to local Gerni distributor.

Symptom	Cause	Recommended action
<b>Machine stops</b>	Fuse has blown Incorrect mains voltage  Thermal sensor activated  Nozzle partially blocked	Replace fuse. Switch off other machines. Check that the mains voltage corresponds to specification on the model tag. Leave the washer for 5 minutes to cool down. Clean the nozzle (see section 6.2)
<b>Fuse blows</b>	Fuse too small	Change to an installation higher than the amp. consumption of the machine. You may try without the extension cable.
<b>Machine pulsating</b>	Air in inlet hose/pump  Inadequate supply of mains water  Nozzle partially blocked Water filter blocked Hose kinked	Allow machine to run with open trigger until regular working pressure resumes. Check that the water supply corresponds to specifications required (see model tag) NB! Avoid using long, thin hoses (min. 1/2") Clean the nozzle (see section 6.2) Clean the filter (see section 6.1) Straighten out hose.
<b>Machine often starts and stops by itself</b>	Pump/spray handle is leaking	Contact your nearest Gerni Service Centre.
<b>Machine starts, but no water comes out</b>	Pump/hoses or accessory frozen No water supply Water filter blocked Nozzle blocked	Wait for pump/hoses or accessory to thaw.  Connect inlet water. Clean the filter (see section 6.1) Clean the nozzle (see section 6.2)

In case problems other than the above occur, please phone 1300 733 171 or check our website [www.gerni.com.au](http://www.gerni.com.au) for your nearest service agent.

## 8 Warranty Conditions

Our goods come with guarantees that cannot be excluded under the Australian Consumer Law. You are entitled to a replacement or refund for a major failure and for compensation for any other reasonably foreseeable loss or damage. You are also entitled to have the goods repaired or replaced if the goods fail to be of acceptable quality and the failure does not amount to a major failure.

Gerni high-pressure washers for domestic use are warranted for 2 years from the date of purchase by:

### **AUSTRALIA:**

Nilfisk-Advance Pty Ltd  
Unit 1/13 Bessemer Street  
Blacktown NSW 2148  
Phone: 1300 556 710  
E-mail: [sales@gerni.com.au](mailto:sales@gerni.com.au)

### **NEW ZEALAND:**

Accent Tools Ltd  
232 Bush Rd  
Albany  
Auckland 0632  
Phone: 09 968 2610  
E-mail: [sales@accent-tools.co.nz](mailto:sales@accent-tools.co.nz)

Equipment defects covered by this warranty will be repaired or replaced by one of the service centres of the Gerni organisation. Find your local service agent here:

<http://www.gerni.com.au/>.

If your high pressure washer or accessories are handed in for repair, it must be followed by a description/specification of the fault, and the original purchase receipt, or a copy, must be enclosed.

Packing and postage/carriage is not covered by the warranty.

The benefits under this warranty are in addition to your national law of sale.

Guarantee repairs are made on the following conditions:

- that defects are attributable to flaws or defects in materials or workmanship. (wear and tear as well as misuse are not covered by the guarantee).
- that the directions of this instruction manual have been thoroughly observed.
- that repair has not been carried out or attempted by other than Gerni-trained service staff.
- that only original accessories have been applied.
- that the product has not been exposed to abuse such as knocks, bumps or frost.
- that only water without any impurities has been used.
- that the high pressure washer has not been used for rental nor used commercially in any other way.

Repairs not covered by the guarantee conditions will be invoiced. (i.e. malfunctions due to **Causes** mentioned in section **Trouble Shooting** of the instruction manual).

**Please phone 1300 733 171 (Australia) or 09 9682610 (NZ) for service or warranty assistance only after checking possible causes in the trouble shooting chart on page 13.**



## 9 Main technical Data

Type		Classic 100.3	Classic 110.4	Classic 115.3	Classic 120.4
<b>Electric specifications</b>					
Rated voltage	V	220-240	220-240	220-240	220-240
Rated frequency	Hz	50/60	50/60	50/60	50/60
Rated power consumption	kW	1.3	1.4	1.4	1.4
Current	A	5.7	6.1	6.1	6.1
Protection class	Class I/ Class II	Class II	Class II	Class II	Class II
Protection degree	IP xx	IPX5	IPX5	IPX5	IPX5
<b>Hydraulic specifications</b>					
Rated pressure	MPa/bar	7/70	7.5/75	8/80	8.5/85
Max. pressure	MPa/bar	10/100	11/110	11.5/115	12/120
Rated water flow	l/min/l/h	5.3/320	5.2/310	5.2/310	5.2/310
Max. water flow	l/min/l/h	7.3/440	7.3/440	7.3/440	7.3/440
Max. water inlet pressure	Mpa/bar	1/10	1/10	1/10	1/10
Max. water inlet temperature	°C	40	40	40	40
Max. water inlet temp. suction mode	°C	20	20	20	20
<b>Weight</b>					
Weight	kg	5.1 (6.1)*	5.5	6.1	6.7
<b>Hand-arm vibration according to ISO 5349-1: Standard nozzle</b>					
Hand-arm vibration according to ISO 5349-1: Standard nozzle	m/s <sup>2</sup>	< 2.5 ±1	< 2.5 ±1	< 2.5 ±1	< 2.5 ±1
<b>Sound pressure level LpA in accordance with ISO 3744</b>					
Sound pressure level LpA in accordance with ISO 3744	dB(A)	74 ±3	74 ±3	74 ±3	74 ±3
<b>Guaranteed sound power level LWA in accordance with 2000/14/EC</b>					
Guaranteed sound power level LWA in accordance with 2000/14/EC	dB(A)	90	90	90	90

We reserve the right to make alterations.

\* C 100.3 S

# 10 Declaration of Conformity

 <b>Declaration of Conformity</b>									
<b>Product:</b>	High Pressure Washer								
<b>Type:</b>	Gerni Classic 100.3 / Classic 100.3 S, Clasic 110.4, Classic 115.3 / Classic 120.4 and accessory variants of above-mentioned types								
<b>The design of the unit corresponds to the following pertinent regulations:</b>	<table border="0"> <tr> <td>EC Machine Directive</td> <td>2006/42/EC</td> </tr> <tr> <td>EC Low-voltage Directive</td> <td>2006/95/EC</td> </tr> <tr> <td>EC EMC Directive</td> <td>2004/108/EC</td> </tr> <tr> <td>RoHS Directive</td> <td>2011/65/EU</td> </tr> </table>	EC Machine Directive	2006/42/EC	EC Low-voltage Directive	2006/95/EC	EC EMC Directive	2004/108/EC	RoHS Directive	2011/65/EU
EC Machine Directive	2006/42/EC								
EC Low-voltage Directive	2006/95/EC								
EC EMC Directive	2004/108/EC								
RoHS Directive	2011/65/EU								
<b>Applied harmonised standards:</b>	EN 60335-2-79								
<b>Applied international standards and technical specifications:</b>	IEC 60335-2-79								
<b>Name and address of the person authorised to compile the technical file:</b>	<p>Anton Sørensen General Manager, Technical Operations EAPC</p> <p>Gerni-Advance A/S Sognevej 25 DK-2605 Brøndby</p>								
<b>Identity and signature of the person empowered to draw up the declaration on behalf of the manufacturer:</b>	<p></p> <p>Anton Sørensen General Manager, Technical Operations EAPC</p> <p>Gerni-Advance A/S Sognevej 25 DK-2605 Brøndby</p>								
<b>Place and date of the declaration</b>	Hadsund, April 15, 2013								

# A

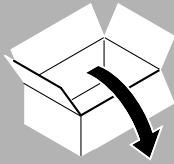

## Classic 115.3

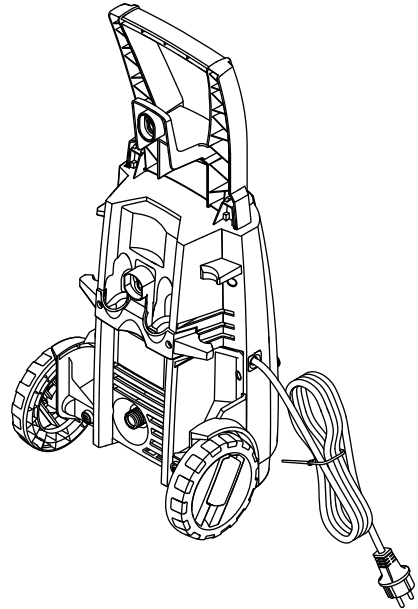
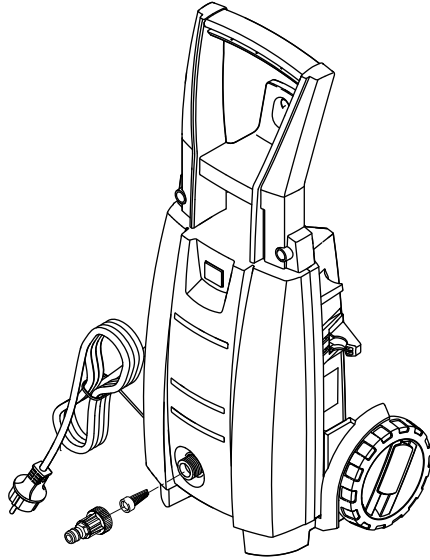

## Classic 120.4

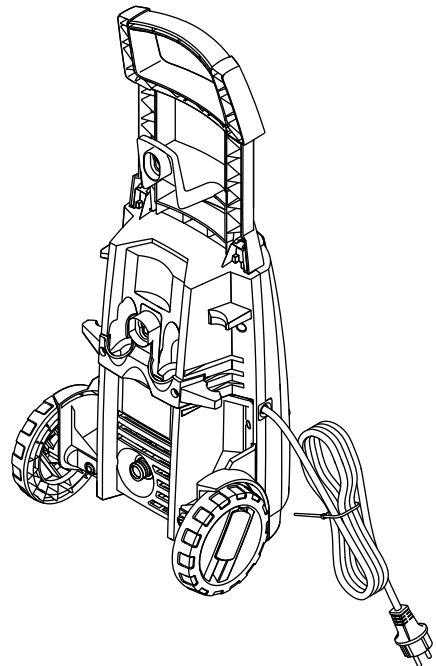
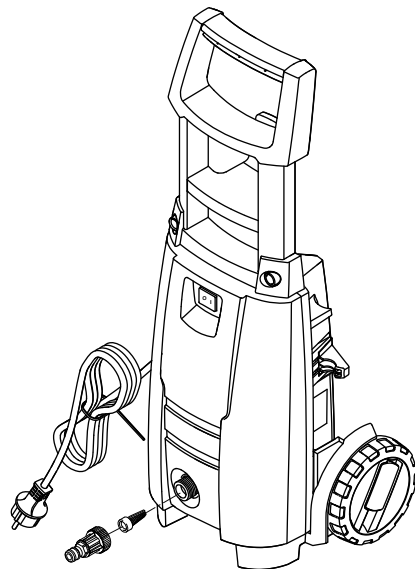

# A

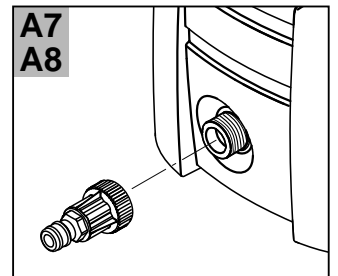
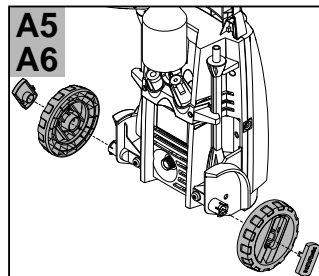
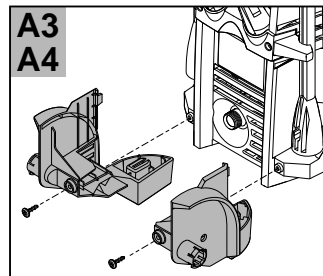
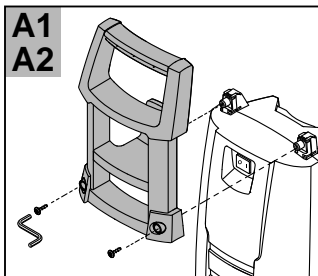
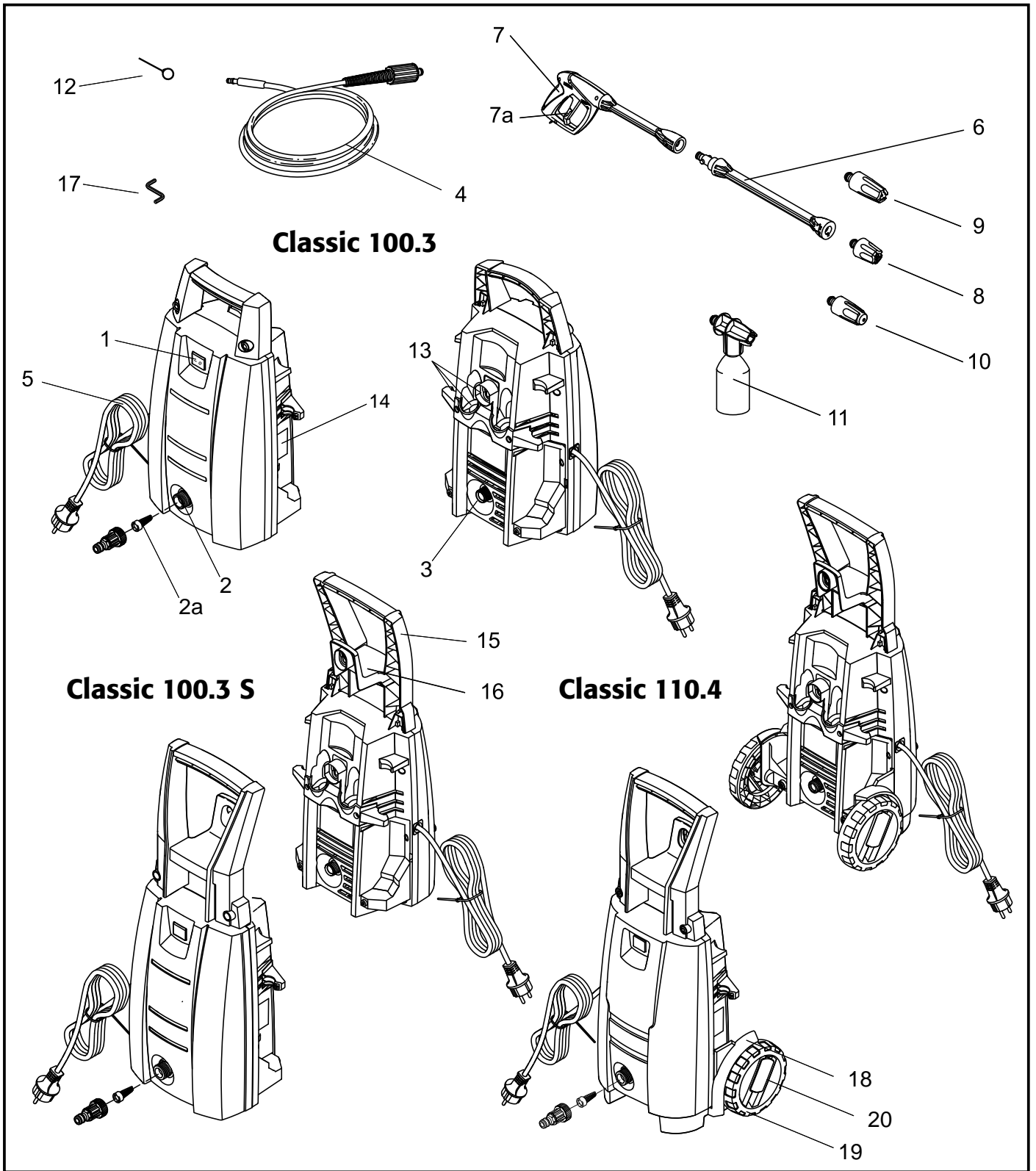
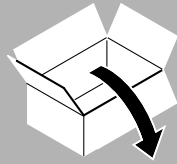

# B

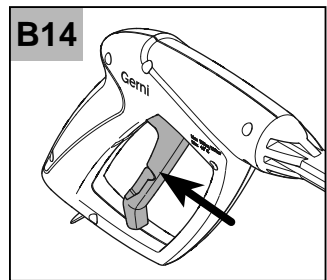
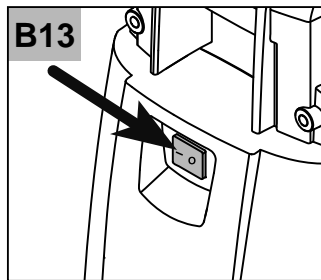
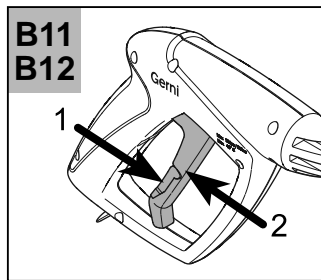
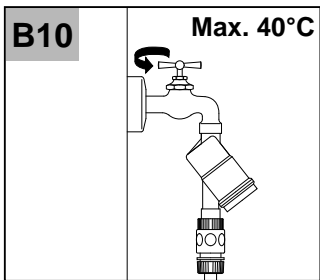
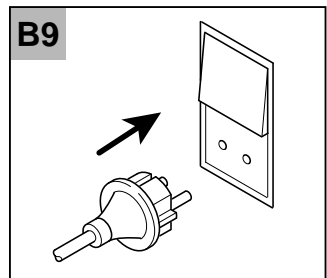
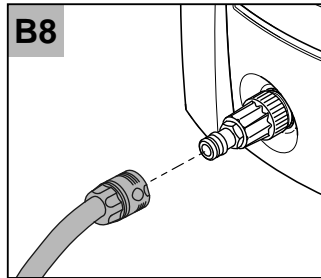
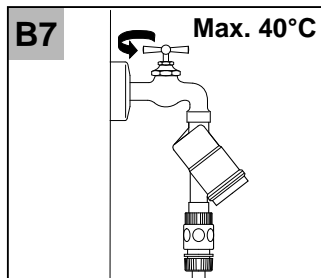
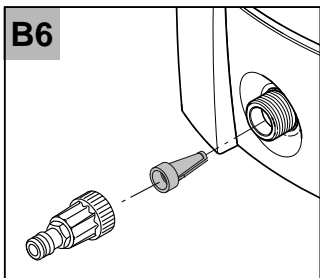
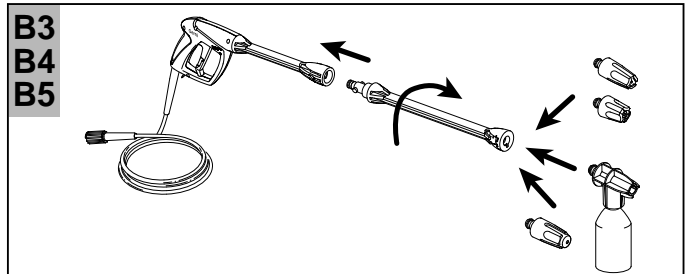
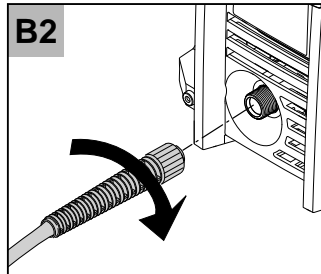
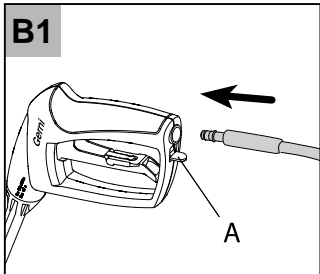

# C

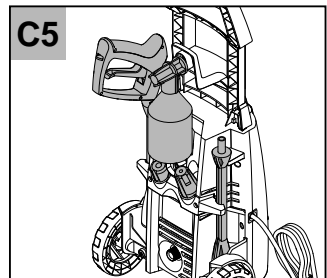
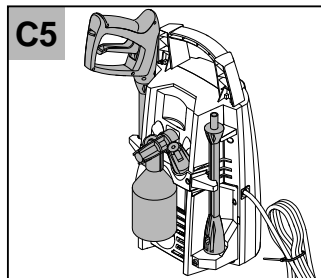
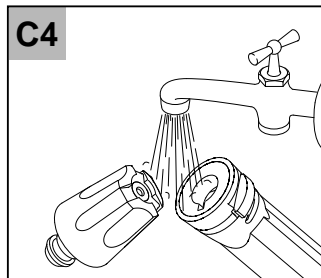
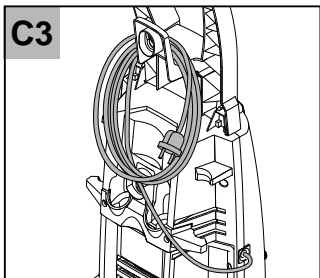
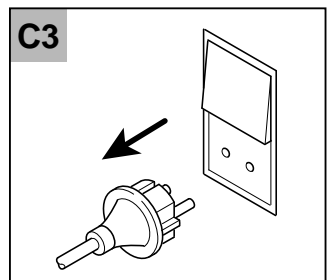
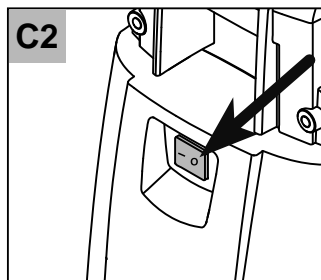
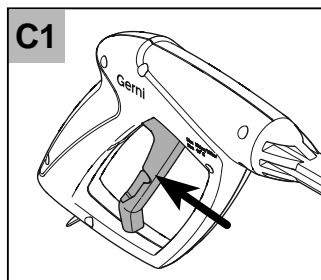
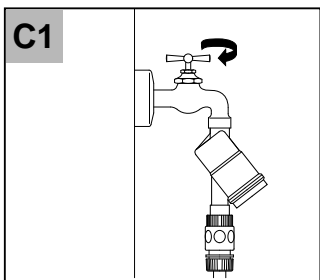
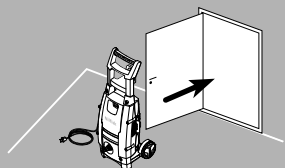



# D

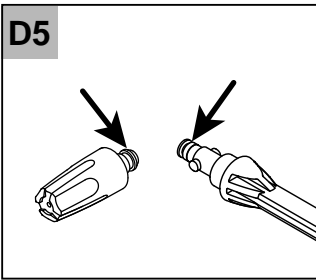
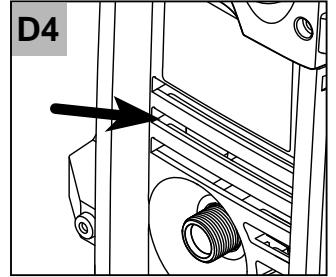
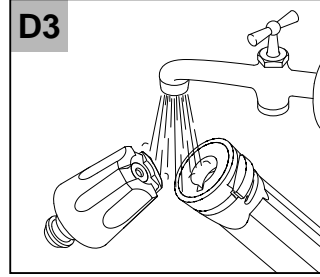
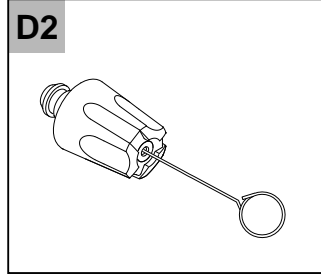
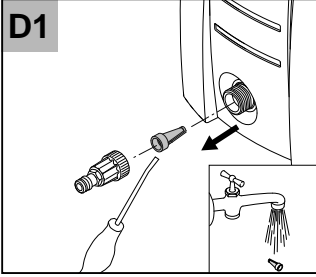

**AUSTRALIA:**

Nilfisk-Advance Pty Ltd  
Unit 1/13 Bessemer Street  
Blacktown NSW 2148

Phone: 1300 556 710  
E-mail: [sales@gerni.com.au](mailto:sales@gerni.com.au)

**NEW ZEALAND:**

Accent Tools Ltd  
232 Bush Rd  
Albany  
Auckland 0632

Phone: 09 968 2610  
E-mail: [sales@accent-tools.co.nz](mailto:sales@accent-tools.co.nz)