

此页不印刷

形式：骑马钉（20P）

尺寸：110x159mm

材质：120g双铜

工艺：单色 双面印刷，封面覆哑膜

Electric Scooter

User Manual

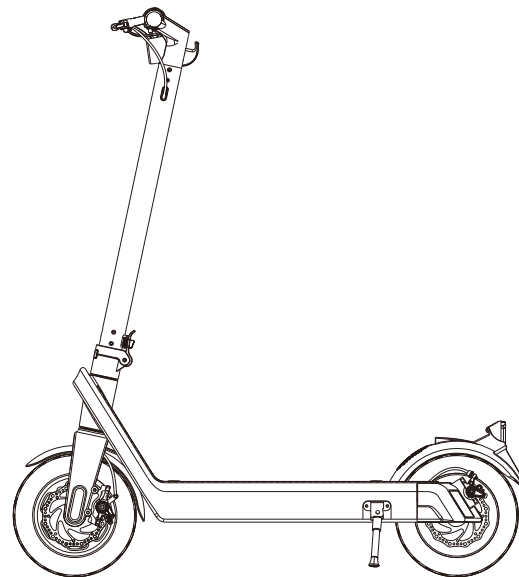

To ensure safe use, please read the instruction manual carefully.
This instruction manual contains important safety information and tips, please read it carefully. Do not use the electric scooter before you read it. Keep the instruction manual properly.

About the manual

- Thank you for choosing and purchasing our electric scooter series products!
- The manual introduces the safe operation instructions and precautions of the electric scooter. Please read them carefully before using them for the first time. If it is not used according to the manual, it may bring danger. Our company will not bear any responsibility for the personal injury or property loss caused by it!
- For the safety, please read the manual carefully before use to ensure correct and safe driving!
- If you have any questions in the use process, or can not get the information you need from the manual, please contact your dealer in time!



Please keep the manual properly for reference at any time!

Content

1. Packing list	2
2. Product Introduction	3-4
3. Product assembly.....	5-7
4. How to ride	8-9
5. Safety notes	10-13
6. Battery instructions	14-15
7. Parameter.....	16
8. Maintenance	17
9. Warranty card	18

Ver:1.0

Packing list

1.Product

Electric scooter*1

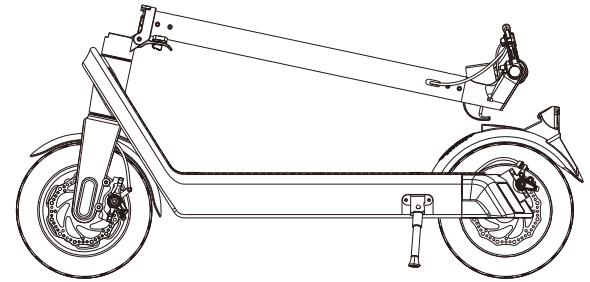

2.Accessories

Charger*1

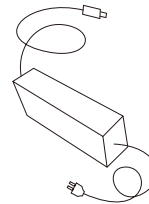

Wrench*1

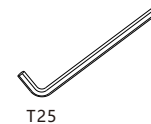

User Manual*1

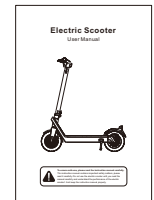

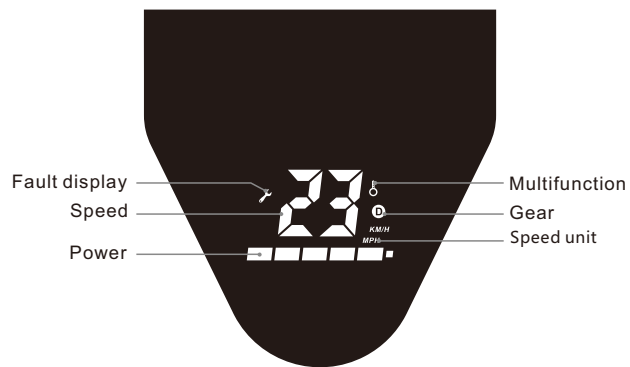
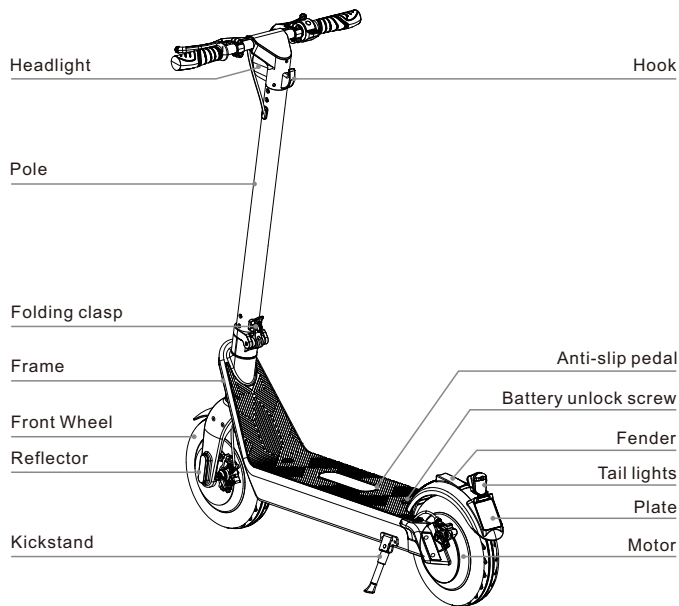
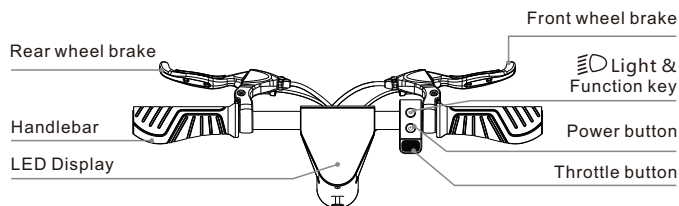

***If anything missed, please contact the dealer in time!**

Product introduction



LED display

Instructions of buttons

- 1. Power Switch:** Long press the power button to turn on/off.
 - 2. Function key:**
 - A:** Short press the function key once: Cycle to switch gears.
 - Pedestrian mode: Gear indicator  is not displayed. The pedestrian indicator flashes in breathing state.
 - Normal mode: Gear indicator  shows white.
 - Sports mode: Gear indicator  shows red.
 - B:** Short press the function key twice: turn on / off the front and rear lights. When the front lights are on, the taillights are always on.
 - 3. Accelerator:** Press throttle button to start and accelerate.
 - 4. Brake:** Hold the brake handle to brake. Lightly step on the rear fender to assist the brakes.
 - 5. Cruise mode:** after the constant speed cruise function is turned on, maintain the current vehicle speed for 6 seconds (vehicle speed $\geq 6\text{km/h}$). Enter the cruise mode automatically, and exit the cruise mode when pressing the acceleration dial again or holding the brake firmly.
- Note:** When the brake is active, pressing the throttle button to accelerate is invalid!

Product assembly

1.How to assemble

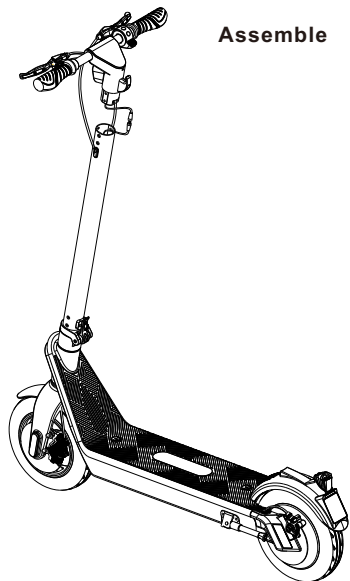

Assemble

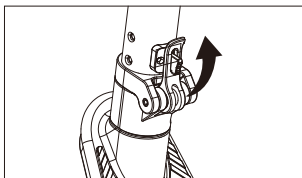

1. Unfold the pole and fasten the folding lock.

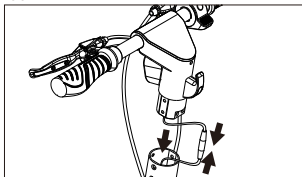

2. Align the communication line terminals of the instrument and the controller with the notch connection.

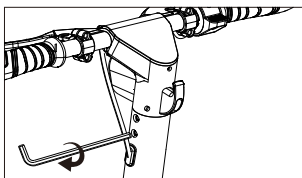

3. Align the T-bar of the scooter then insert it into the pole, use the screw provided with the scooter to install and fix it.

Disassemble

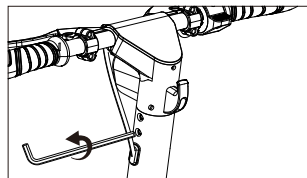

1. Loosen the screws that secure the T-bar of the scooter.

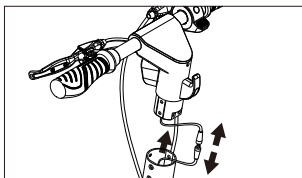

2. Pull out the head of the scooter, unplug the communication line between the display and the controller, the dismantling part of the head of the scooter is complete.

2.How to fold

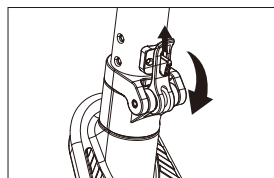
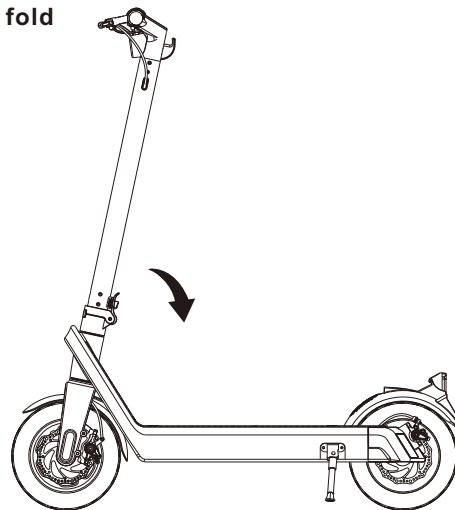

1. Lift the folding wrench.

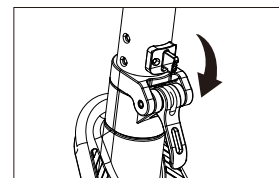

2. Open the folding wrench.

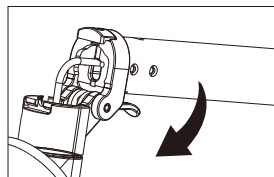

3. Fold the pole.

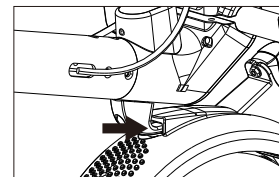

4. Gently press down the hook to the rear baffle.

3. Battery removal and installation.

Remove the battery

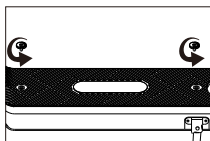
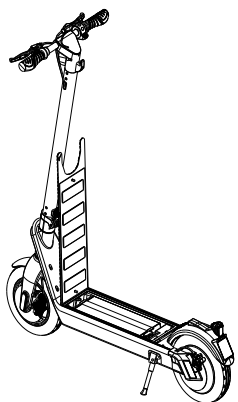

1. Unscrew the pedal cover screw counterclockwise.

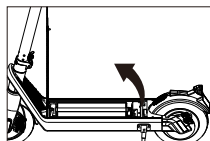

2. Lift the pedal cover from the quick-release screw on the rear wheel side.

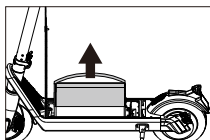

4. Lift the battery strap and take out the battery.

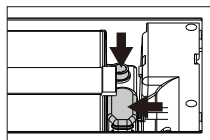

3. Unplug the charging plug and the power plug of the controller.

Install the battery

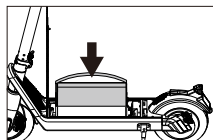

1. Put the battery vertically into the scooter.

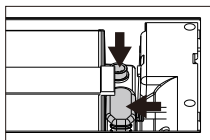

2. Connect the charging plug and the power plug of the controller to the battery.

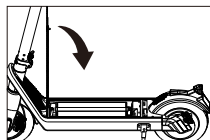

3. Cover the pedal and fasten the silicone edge of the pedal.

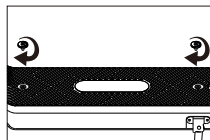
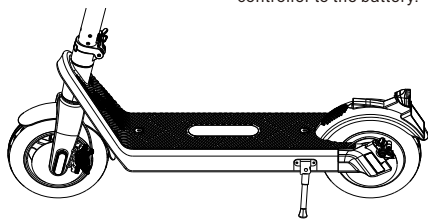

4. Install the screws and tighten it clockwise.

How to ride

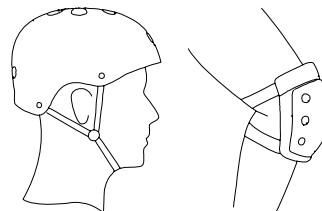

1. Wear helmets and other protective equipment before riding.

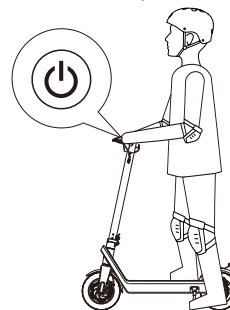

2. Long-Press the power button to turn on scooter, stand on the pedal with one foot, press the accelerator, and push the other foot back on the ground.

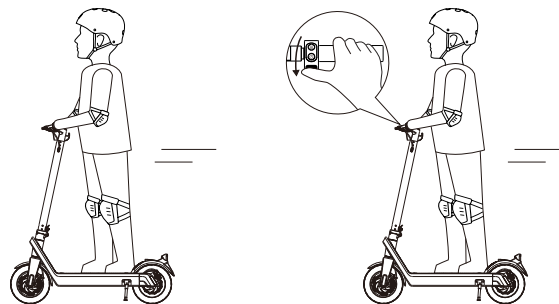

3. When the electric scooter is sliding, put the other foot on the pedal and keep both feet remain stable.

4. Continuously press the throttle to speed up. Turn the handle to adjust the direction.

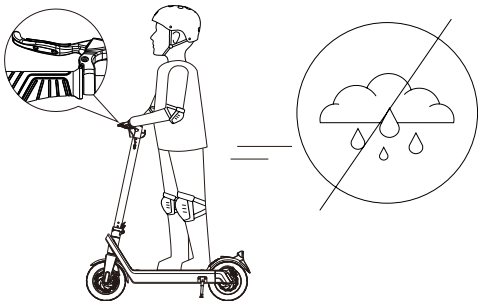

5. Hold the brake grip firmly to slow down and stop.



Note:

1. Riding in rain or snow, the braking distance will be extended. Pls pay attention to slow down.
2. The rear brake can be used for normal driving. The front and rear brakes need to be used together for emergency braking. Don't use the front brake for emergency braking at high speed. Otherwise, it can cause a rollover.

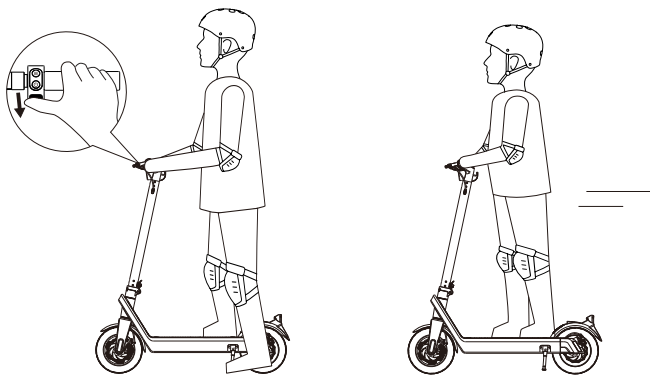

6. When the scooter stops or runs at a slow speed, you can get off.

7. Please don't ride at high speed before you are familiar with the performance of the scooter to avoid accidents.

Safety notes

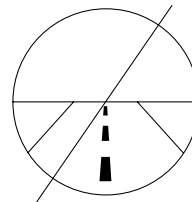

1. Please abide by traffic laws when using electric scooters. Forbidden to ride it into motor lanes.

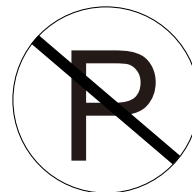

2. Don't park electric scooters in the building's lobby, evacuation corridor, or safety exit.

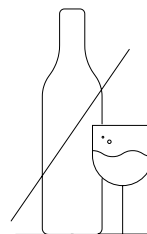

3. DO NOT ride after drinking or taking medicine.

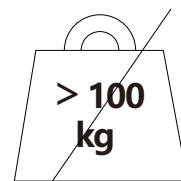

4. Forbidden to ride with overweight (maximum load: 100Kg).

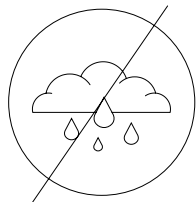

⚠ 5. Forbidden to ride on the road with heavy water, which is easy to cause danger.

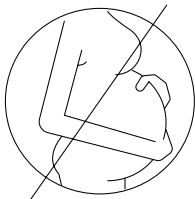

⚠ 6. Pregnant women and users younger than 14 years old are not allowed to ride.

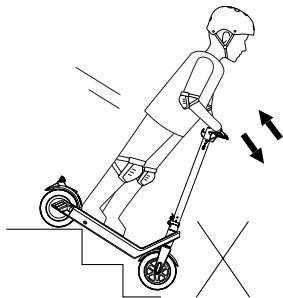

⚠ 7. Forbidden to ride electric scooters up and down steps or jumping obstacles.

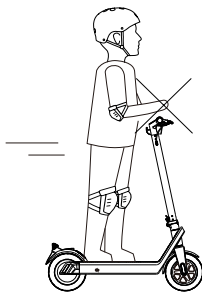

⚠ 8. Forbidden to leave the handlebar with one hand or both hands at the same time when riding.

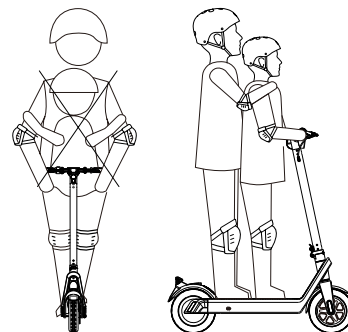

⚠ 9. Forbidden for multiple people or carrying children to ride an scooter at the same time.

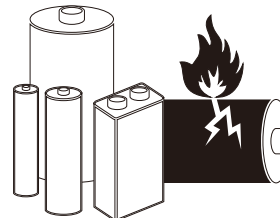

⚠ 10. Forbidden to modify the battery of an electric scooter privately. Modification of the battery is dangerous, and improper operation may cause the battery to explode or fire.

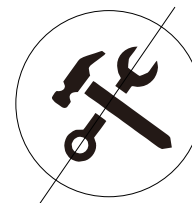

⚠ 11. Forbidden to modify electric scooters privately. Private modification may cause an unstable electronic system and cause danger when riding.

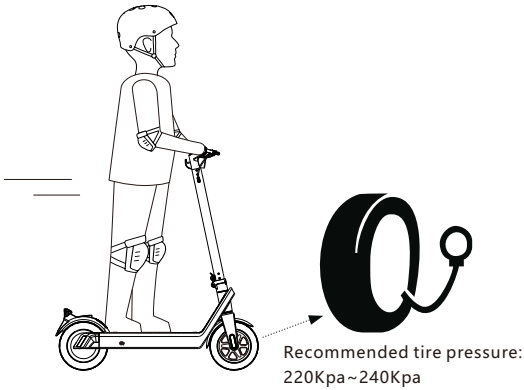

- ⚠ 12. Before riding an electric scooter, please carefully check the scooter condition make sure that there are no signs of looseness or damage on any part.

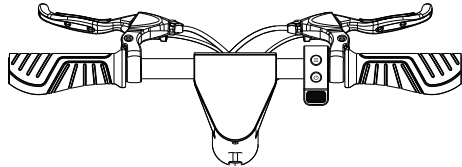

Power circuit, front and rear brakes

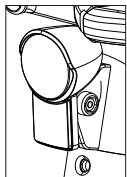

Front light

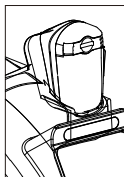

Rear light

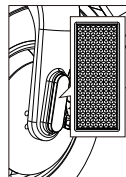

Reflector

- ⚠ 13. Before using the electric scooter, check whether the power circuit, front and rear lights, reflectors, front and rear brakes are normal, and stop using it and repair it in time if there is an abnormality.

Battery instructions

This is about how consumers charge and maintenance, also hereby listed the detailed spec of battery for your info, please refer to this manual well and follow so as to keep long lifespan, performance for the battery.

6.1 Battery parameters

Name	Parameter	Name	Parameter	Name	Parameter
Type	Li-ion battery	Battery Capacity	10.4Ah/15.6Ah 20.8Ah optional	Rated Voltage	36V
Max Charging Voltage	42V	Max Charging Current	2A	Charging time	6-9h
Temperature	-10~40°C	Charging Temperature	0~40°C	Store Time (-10~40°C)	3 months (full charge)

6.2 Warns for battery

- The battery must be charged and used within the temperature range required by the battery specification to make the electric scooter work stably and efficiently.
- Please make sure you take off the charger when you install the battery to prevent any danger from happening.
- It is never allowed to dissolve or impale the battery, also make sure NO metal stuff go contact with the battery pin electrode, otherwise it might break the battery.
- It is forbidden to disassemble or pierce the battery pack casing to avoid short circuit caused by metal objects contacting the battery contacts, otherwise it may cause battery damage or personal injury.
- It is potentially causing fire or explosion if water entering battery circuit, thus stop using the battery in case this happening and go to the after sale immediately.
- You are only allowed to charge the battery with the original adaptor packed, otherwise it will be causing any unexpected consequence.
- If finding the battery broken and smells bad or felt hot, you need to stop using and keep the battery away from other stuffs.
- It helps prolong the lifespan if storing battery after 100% fully charged
- It is not allowed to store the battery under -20°C or higher 50°C condition.
- You have to charge it to at least 80% capacity if battery not used more than 30 days. Better to charge it 100% full every 90 days to protect the battery function.
- It will help prolong the battery lifespan significantly that you charge well accordingly to the manuals after every driving instead of running it out. At room temperature, the battery can play a higher range and performance. But battery life and performance will degrade if used at temperatures below 0°C. Typically, the range may be half or less than at room temperature at -10°C.
- Do not charge and park electric scooters in residential buildings. Keep away from combustibles when charging, and the charging time should not be too long.

13. Improper disposal of used batteries may seriously pollute the environment. Please abide by local regulations when disposing of this battery.

⚠ Tips:

1. When the internal temperature of the battery exceeds 50°C, the battery is in a protected state and cannot be charged.
2. After fully charged, the electric scooter exhausts its stored power after about 90-120 days of standby. If it is not charged in time, it may cause damage to the battery due to excessive discharge. This damage is unrecoverable and it is beyond of our warranty.

6.3 Charging steps

- Open the charging port cover, Make sure the charging port is clean and dry.
- Connect the charger with the battery and the other end with power(100V-240V;50/60Hz), make sure the charging indicator is on.
- When the indicator light on the charger changes, indicating that the charging process is normal, otherwise check if the line connection is good.
- The indicator turns green when the charger is charging, it indicates that the battery has been filled to 99%, Please stop charging; long time over charge will affect the battery life.

Tip: When the battery is charged separately, the charging status can be viewed on the charging indicator on the battery. It displays red color when charging and green color after full charging.

Changing method 1:

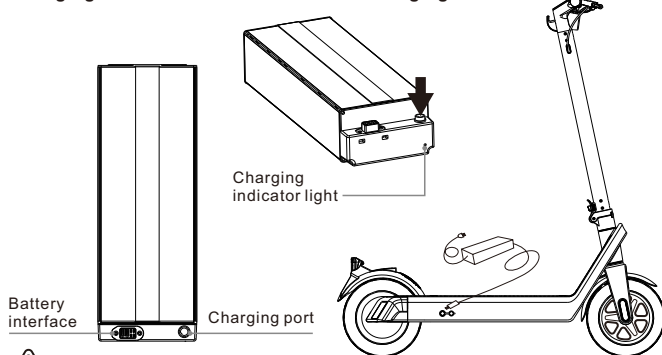

⚠ Note:

- Remove the battery to open the silicone charging port, plug the charger DC plug into the battery charging port; plug the power cord into the charger, then connect the other port to the socket (100V-240V; 50/60Hz), and confirm the charger indicator is on normally.
- Only use the original electric scooter charger for charging. Do not use any other models of power chargers to avoid danger caused by voltage mismatch.

Parameter

Product name	Electric scooter	
Main specification		
Unfolding size:	mm*mm*mm	1110*530*1230
Folding size:	mm*mm*mm	1110*530*535
Center distance of front and rear wheels	mm	825
Net Weight	kg	23
Max speed	km/h	40
Max load	kg	100
Max climbing angle	°	15
Operating temperature	°C	-10 ~ +40
Storage temperature	°C	-20 ~ +45
Waterproof level	/	IPX4
Battery specification		
Battery type	/	Li-ion battery
Battery capacity	Ah	10.4/15.6/20.8 optional
Rated voltage(DC)	V	36
Maximum charging voltage(DC)	V	42
Motor specification		
Motor type	/	Permanent magnet brushless
Rated power	W	500
Rated voltage	V	36
Charger specification		
Input voltage(AC)	V	100~240(50~60Hz)
Output Power	W	84
Output voltage	V	42
Output current	A	2

Maintenance

8.1 Maintenance considerations :

- Make sure the electric scooter charger and charging line are disconnected and ensure that the electric scooter is off.
- Wipe the shell with a soft cloth to clean the electric scooter. Please don't put more lubricating oil on bearing when you do the maintenance for it.
- Please check the brake system and tire are vulnerable parts at least once a month. When the brake performance and tire grip are reduced, please contact the dealer to replace the corresponding parts.
- Please do not replace the accessories which not provided by manufacturer without permission, to avoid the safety hazard caused by the inconsistency for accessories with the scooter.
- It is forbidden to clean electric scooters by using water cannon or soaking in liquid. This will cause permanent damage of the electronic devices in the host.
- In order to protect the user's safety, the user can not take apart the electric scooter, otherwise, the user will give up the maintenance warranty rights of the product automatically.



Tips:

- Please charge your electric scooter before storage, for preventing the battery from discharging too long time. Please ensure charge at least once every three months.
- If the storage environment temperature is lower than 0 °C, please don't charge electric scooter. Please put it in inside environment temperature (above 10 °C) and then charge, storage temperature is - 10 °C to 35 °C.
- Please keep the electric scooter in a suitable place indoor, dry and appropriate temperature. You can mask the electric scooter to prevent from the dust.

8.2 Maintenance of tires.

The tires of this product are pneumatic. When the tire height sinks 20%-30%, it needs to be inflated. The recommended inflated tire pressure is 220-240 Kpa. The tire needs to be inflated at least once in 2-3 months. Regular inspection of the inflation can reduce the puncture situation and extend the life of the tire.

Warranty card

9.1 The product has passed the inspection of the quality control department and allowed to be sold.

Please keep the warranty card and purchase invoice properly, and present the warranty card and purchase invoice when repairing.

Effective date :

Quality inspection pass seal:

9.2. Warranty Card

Username		Gender		Age	
Mailing address					
Phone				Zip	
Purchase address					
Price		Sales order number			
Description & Specification			Body number		
Dealer signature			User signature		



Please keep the warranty card and purchase invoice as after-sales proof. This card must be provided during the warranty. If this card is not provided or the card is altered privately, the company has the right to do non-warranty treatment!