



The SINGER Zigzag Attachment is only one of many attachments available at your SINGER SEWING CENTRE . . . attachments which will enable you to produce all kinds of decorative effects and finishes with a minimum of time and effort . . . attachments which can give your home sewing that smart professional look.

YOUR SINGER SEWING CENTRE stands ready to help you with instructions and advice on Home Dressmaking and Home Decorations. You'll also find a hundred and one other helpful sewing services and supplies. Our finishing services include Hemstitching, Custom Made Belts, Button and Buckle Covering, Picoting. Here too you will also find the widest selection of thread zippers, buttons and other notions.

Drop in and get acquainted at your.

98/8
SINGER SEWING CENTRE



SINGER AUTOMATIC ZIG-ZAG ATTACHMENT

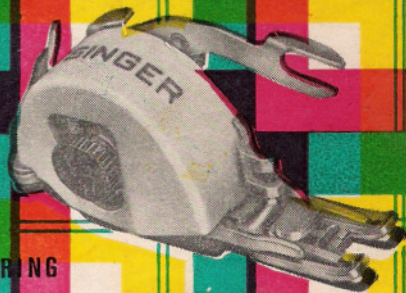

160 991
THE
SINGER
MANUFACTURING
COMPANY

* A trademark of

THE SINGER MANUFACTURING COMPANY

Printed in Switzerland

Contents

Principal Parts of the Singer Automatic	3
Zigzag Attachment	5
Before Fastening the Zigzagger to the Machine	5
Now Fasten the Attachment to the Machine	7
Directions for Zigzag Sewing	9
Regulating Stitch Length	9
Regulating Bight Control	10
Straight Stitching	12
Automatic Zigzag Stitching	14
Further Ornamental Effects	
Examples of Special Applications	
Overedging Seams	17
Attaching and Inserting Lace	20
Inserting a Patch	23
Cording	25
Applique	25
Blind Stitching	29
Cleaning and Oiling the Attachment	31

INSTRUCTIONS FOR USING

SINGER*

AUTOMATIC ZIGZAG

ATTACHMENT 160991

This new Singer* Automatic Zigzag Attachment is designed to produce regular zigzag stitches and a wide variety of ornamental stitches. It is so simple to operate that you will be able to create intricate designs and effects after studying these instructions and a little practice.

4 5 2 1

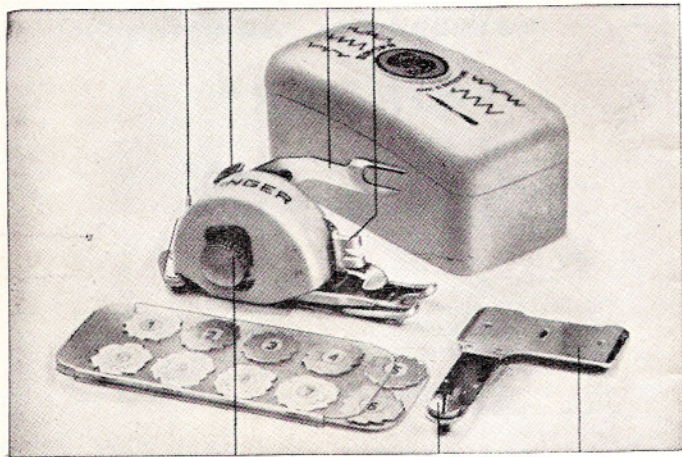

3 8 7 6

2

Cleaning and Oiling the Attachment

The Singer Automatic Zigzagger requires a minimum of care. Just as with all precision instruments, it requires an occasional oiling. For best results, apply a drop (not more than two drops) of SINGER oil to all movable parts of the zigzagger at the same time that you clean your sewing machine. The oiling points are indicated by arrows in the illustration on the opposite page. Be sure to wipe off with a piece of cloth all excess oil before starting to sew on a garment. A regular cleaning will keep the attachment operating smoothly and quietly and will increase its years of usability.

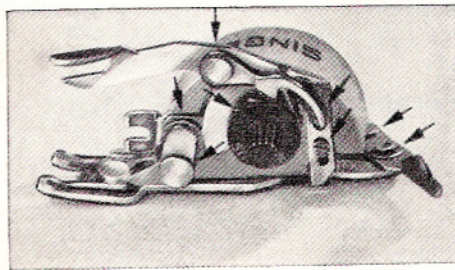

31

Settings:

Stitch length regulator screw 3 set at highest position

Bight control lever 4 set according to the material being worked

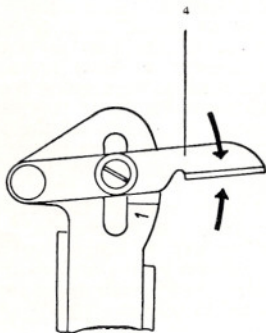
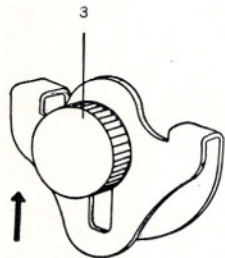

The Principal Parts of the Singer Automatic Zigzag Attachment

1. **Driving Lever** – straddles the needle clamp and actuates the zigzagger
2. **Shank** – attaches zigzagger to presser bar in place of regular presser foot
3. **Stitch Length Regulator** – controls stitch length (distance between stitches)
4. **Bight Control Lever** – regulates width of zigzag stitch
5. **Straight Stitching Lever** – changes stitching from zigzag to straight
6. **Feed Cover Plate** – must always be fastened over throat plate so that feed dog teeth are covered
7. **Cover Plate Set Screw** – fastens plate to bed of machine
8. **Cams**

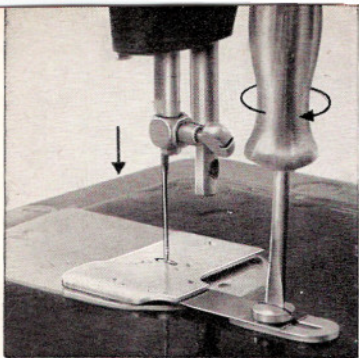

Fig. 1

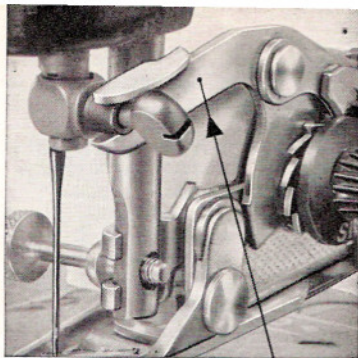

Fig. 2

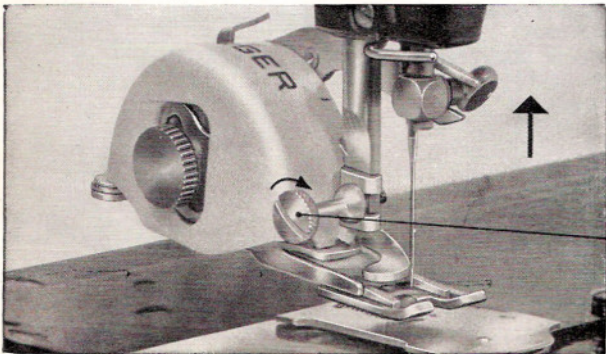

Fig. 3

B

Blind Stitching

Hand finishing of dress and skirt seams and hems is very time consuming and tedious. The zigzagger attachment is capable of performing this work very quickly and easily.

First place pattern cam No. 4 on the attachment as described on page 11 and set stitch length regulator screw 3 at its highest position.

Next prepare the material as follows:

Place the material right side down under the foot. If the material has a closely woven edge, then fold the hem as shown at **A**. If the material has a raw edge, then fold the hem as shown at **B**. For best results, iron over the hem or make some rows of stitches beforehand. Next guide the material under the foot as shown in Fig. 26 so that the upper fold passes directly under the middle of the foot. Regulate bight control lever 4 so that the needle pierces the folded edge of the material as the foot moves the material to the right.

If heavy material is used, the blind stitch will remain invisible. If lightweight fabric is used only a single stitch will be visible on the right side of the garment as shown by the arrows in Fig. 26.

Use a fine needle and a thread which matches the material in colour.

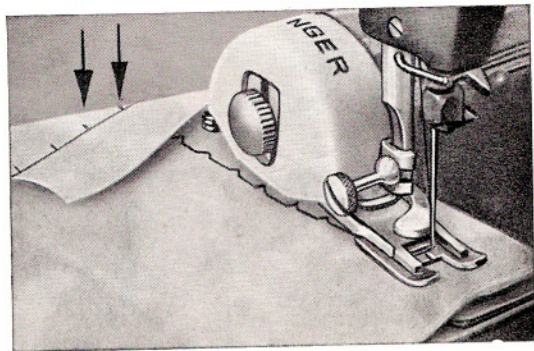
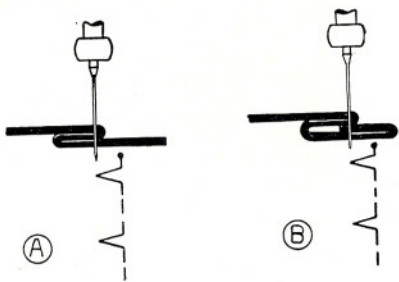
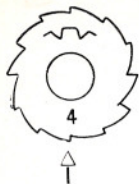

Before Fastening The Zigzagger To The Machine

- remove the presser foot and thumb screw from the machine
- lower the feed of the machine as far as possible
- fasten the feed cover plate to the bed of the machine, as shown in Fig. 1 making certain to locate it in such a way that the needle will penetrate at the exact centre of the needle hole in the plate without touching the sides of the plate.

Now Fasten The Attachment To The Machine

as is done with a regular presser foot. Be sure to raise the needle bar to its highest position. Guide zigzagger into position from rear of machine see Fig. 2 so that fork of driving lever 1 Fig. 2, straddles hub of needle clamp, and securely fasten shank to presser bar with clamping screw B, Fig. 3.

Fig. 26

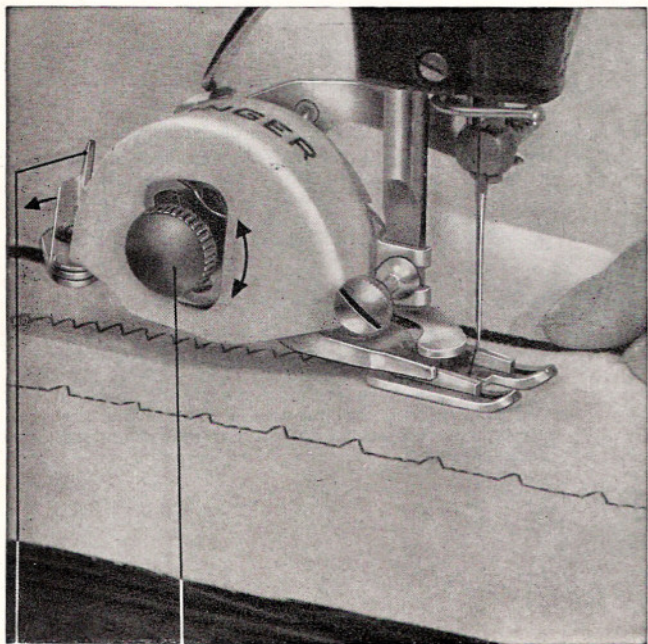

Fig. 4

shown at **b** and then trim away the excess material from the applied cloth close to the stitching as shown at **c**, Fig. 25. Finally overstitch the raw edges and the straight stitching with a close satin stitch as shown at **d**, Fig. 25. The resulting stitch will appear similar to the stitch shown at **A**, Fig. 24.

Settings :

Stitch length regulator **3** set at lowest position

Bight control lever **4** set at approximately centre position.

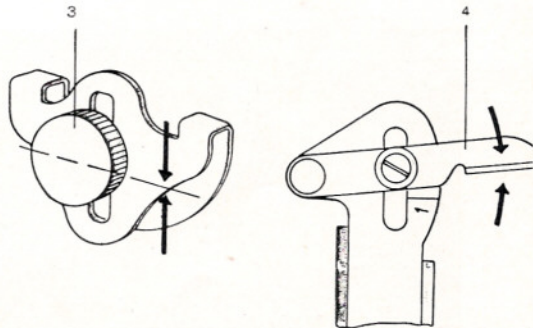

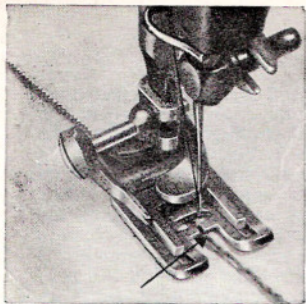

Fig. 24

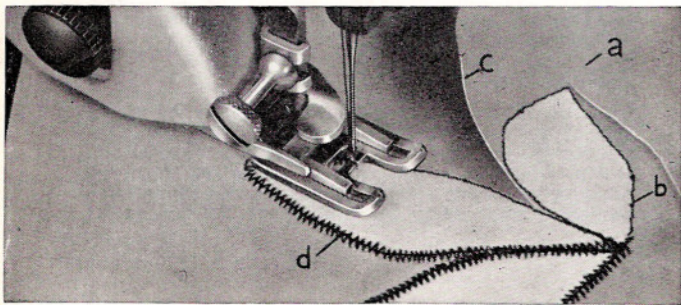
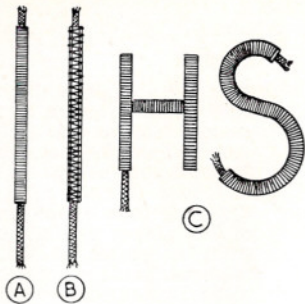

Fig. 25

Directions For Zigzag Sewing

Thread the machine as for regular stitching. Draw the **lower** thread upward and lead both the lower and upper thread toward the rear of the machine. The upper thread should pass through the slot in the foot of the attachment.

Move bight control lever **4**, Fig. 4 all the way back. Loosen stitch length regulator screw **3** by turning it to the left, move the screw up or down until it is approximately in the middle of its slot, then tighten screw by turning it to the right.

Position the material under the attachment and lower the presser bar lever.

Sew slowly at a constant rate. Guide the material lightly as shown in Fig. 4, but do not attempt to pull the material as the attachment will feed the material without assistance. Normally it is not necessary to vary the thread tensions of the machine. However, when sewing on thin materials or on materials of different thicknesses, it may be advisable to tighten the upper tension slightly and loosen the lower tension a bit. The tension is correct if the zigzag stitch is of a uniform width on both sides of the material.

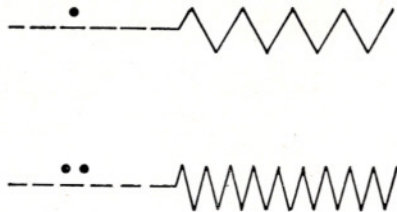
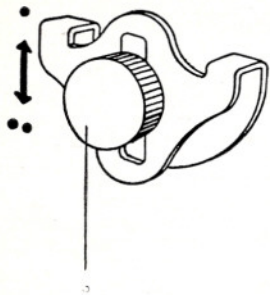

Fig. 5

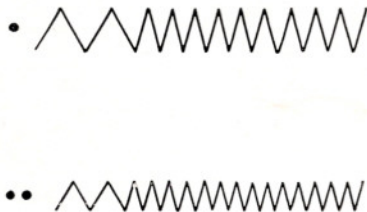
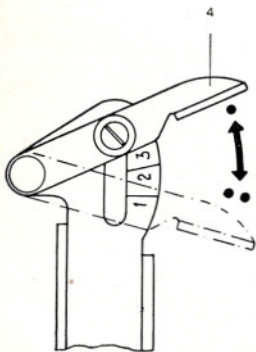

Fig. 6

Cording

First, trace or draw the desired motif on the material. Then place a length of cotton filler cord under the presser foot so that it leads through the slit in the center of the foot as shown in Fig. 24 and over stitch the cord with narrow zigzag stitches which are placed so closely that the cord is completely covered. Stitch along the lines of the tracing or drawing, placing the cord in proper position while stitching. A corded satin stitch as shown at A is formed in this manner. If coloured thread is used for the filler cord and if a contrasting colour thread is used for over stitching, the result is still more effective. Most important for this use is to lengthen the stitch so that the effect is similar to illustration B. In addition this type of cording makes possible a simple way of creating interesting monograms as shown at C.

Applique Work

Draw the mirrored outline of the design on the wrong side of the material. Place the second piece of material for the applique on top of the main material and fasten it by basting as shown at a, Fig. 25. Then, sewing on the wrong side of the main piece of material, straight stitch along the outline of the design as

Setting:

Length regulator screw 3 set slightly below centre
Bight control lever 4 set as far back as it will go

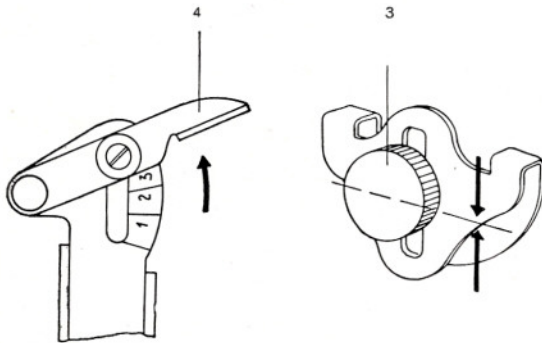

Regulating Stitch Length

The most outstanding feature of this SINGER Zigzag Attachment is its own feeding device which operates completely independent of the machine feed.

Loosen red thumb screw 3, Fig. 5 by turning it over to the left

Move screw down for a shorter stitch

Move screw up for a longer stitch

Tighten screw by turning it over to the right when desired stitch length is attained.

Regulating Bight Control

Lever 4, Fig. 6 located at the back of the attachment, is used to regulate the bight (width of zigzag stitches).

If the lever is moved toward the operator to the line marked «1», a narrow zigzag stitch is produced. If the lever is moved all the way back to the mark «3», a very wide zigzag stitch will be produced. Any number of widths between these limits can be produced by regulating the lever back or forth for the desired effect.

Straight Stitching

If it is desired to interrupt the zigzag stitching with straight stitching, this can be done by raising lever 5, Fig. 7 and holding it in the raised position as long as straight stitching is desired. For continuous straight stitching, it is possible to fix lever 5 in its highest position by pulling the bight control lever 4 as far forward as possible when lever 5 is in its highest position.

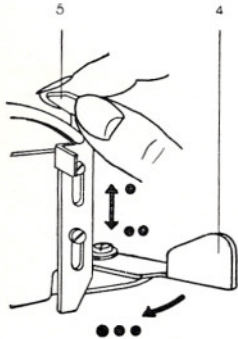

Fig. 7

Inserting a Patch

Large rents or tears are repaired easily and quickly by zigzag stitching a patch over the damaged fabric. The following method is suitable for all types of material, especially tricot and other stretchable materials. Cut a square piece of fabric somewhat larger than the damaged area and cover the tear or rent. (Be sure to match the direction of weave!) Start to overedge the patch with a wide zigzag and an average stitch length as shown in Fig. 19. The corners should be stitched over double as shown in Fig. 21. The upper thread tension should be loosened slightly. When the patch has been sewn in place, trim away the excess torn material from the underside of the garment close to the row of stitching as shown in Fig. 20.

The zigzag stitch also facilitates seaming of knitted goods as shown in Fig. 22. Fig. 23 illustrates the unusual amount of elasticity offered by the zigzag stitch.

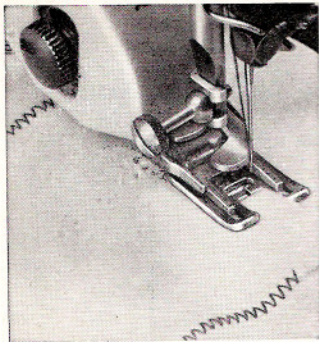

Fig. 19

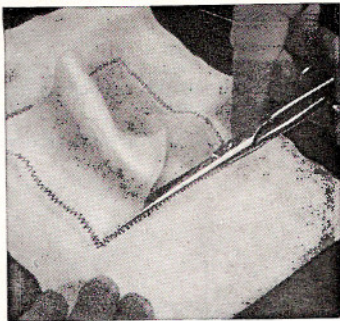

Fig. 20

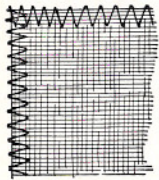

Fig. 21

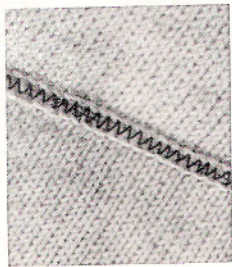

Fig. 22

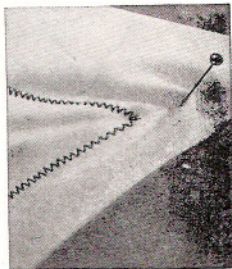

Fig. 23

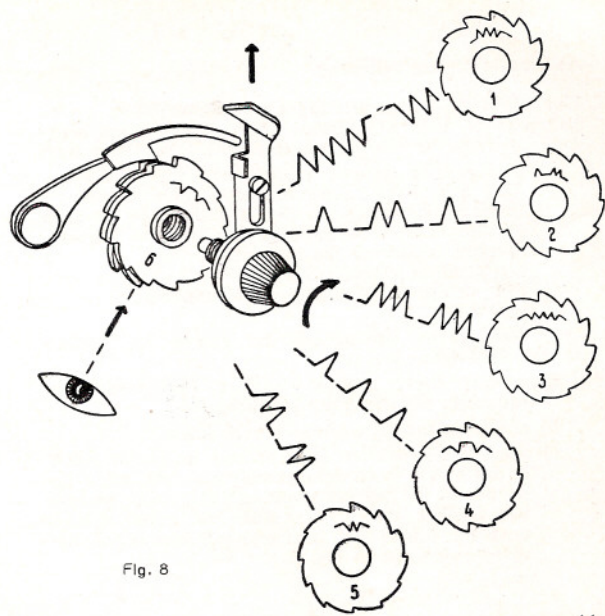

Fig. 8

Automatic Zigzag Stitching

The SINGER Automatic Zigzag Attachment is provided with 10 different pattern cams. These cams broaden the range of effects possible with the attachment.

Choose the desired sample and the corresponding cam from those shown in Figs. 8 and 10. Loosen lock screw **S**, **Fig. 9** and place the cam on the cam shaft making certain that the cam number is toward the outside.

Lift straight stitching lever **5**.

Fix pattern cam in place by tightening set screw **S**.

Each pattern or design can be varied for further interesting effects by:

- moving bight control lever **4** backwards and forwards slowly while stitching
- changing the stitch length with knob **3**
- sewing the pattern in mirrored image of itself, as follows: At predetermined intervals, raise the needle to its highest point, slightly raise presser bar so that presser foot does not make contact with the fabric and turn screw **S** one notch forward as shown in **Fig. 9**.

Setting:

Stitch length regulator screw **3** set at approximately the midpoint.

Bight control lever **4** also set at its middle position.

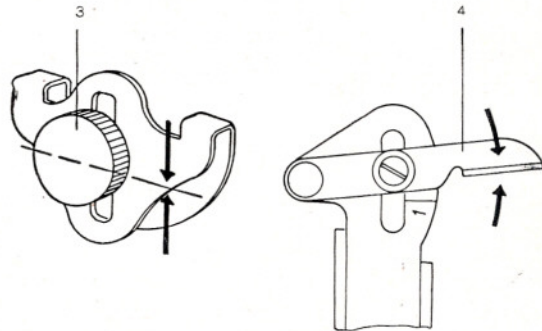

Attaching and Inserting Lace

Attaching Lace

Make a $\frac{1}{2}$ in. fold toward the bottom along the edge of the material and press the fold with an iron. Place the lace so that it slightly overlaps the folded edge of the material. Lead both the lace and material under the presser foot so that a narrow zigzag stitch with average stitch length will attach the two together, as shown in Fig. 16. Trim away excess material close to the line of stitching.

Inserting Lace

First fasten the lace to the garment by sewing straight stitches along both edges of the lace. Then cut apart the material under the lace between the two rows of straight stitches as shown in Fig. 17. Next fold under the flaps of material to the left and to the right and overstretch both edges of the lace with a narrow zigzag stitch, as shown in Fig. 18. Finish off the insertion by trimming away the excess material close to the zigzag stitching.

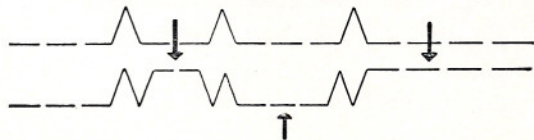
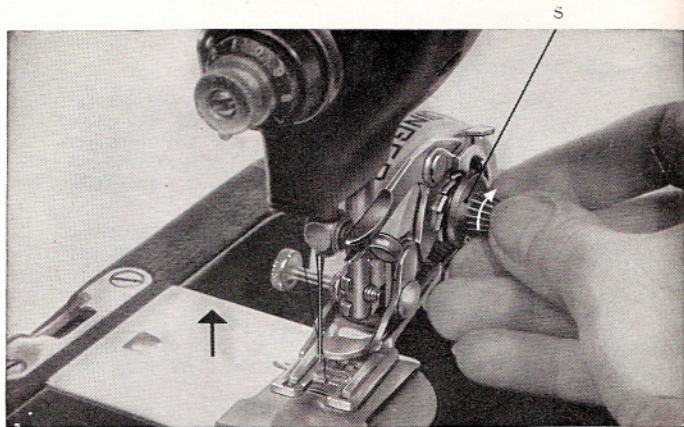

Fig. 9

Further Ornamental Effects

can be produced if the thread tensions are set for a «Spark stitch». The additional pattern cams are especially well suited for this advanced sewing technique. Fig. 10 shows the additional cams Nos. 6 to 10 with the designs made with each cam:

At the left: sewn with regular thread tensions
At the right: sewn as «spark stitch» with altered tensions

The spark stitch is accomplished by loosening the bobbin thread tension and tightening the upper thread tension. In this manner the loops from the under-thread are pulled through the material to the top surface.

The effect of the spark stitch is further enhanced by using different coloured threads. Still other effects can be achieved by using crochet thread in the bobbin or, using the spark stitch, fasten varicoloured braids to a garment.

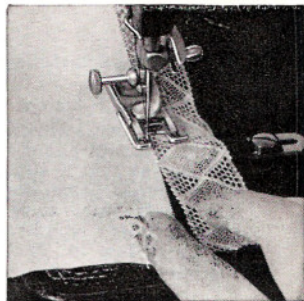
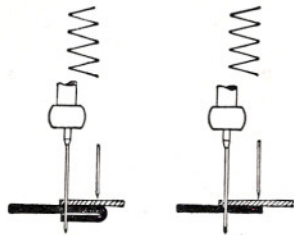

Fig. 16

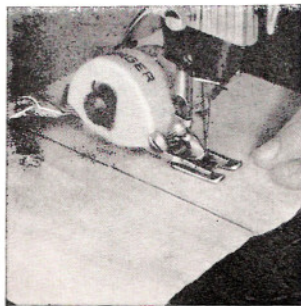

Fig. 17

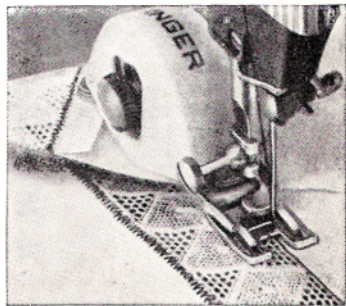

Fig. 18

Setting:

Set stitch length screw 3 fairly high

Move bight control lever 4 all the way to the rear

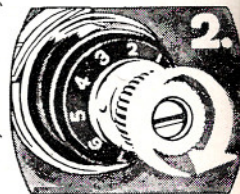
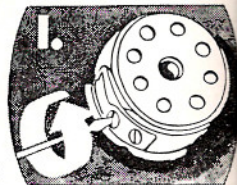
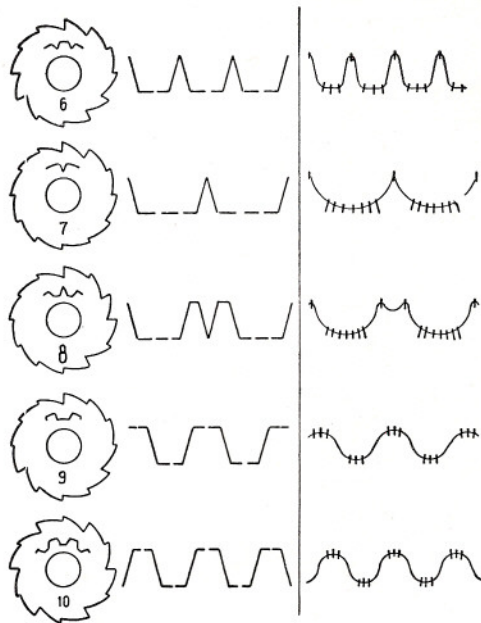
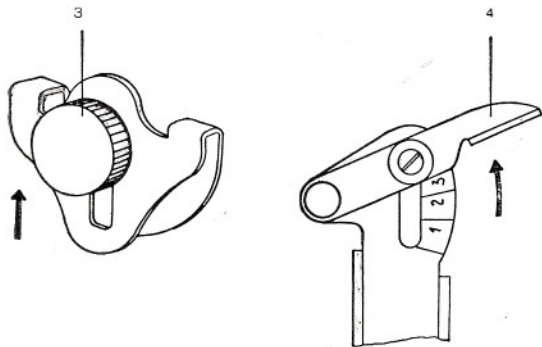

Fig. 10



Fig. 13

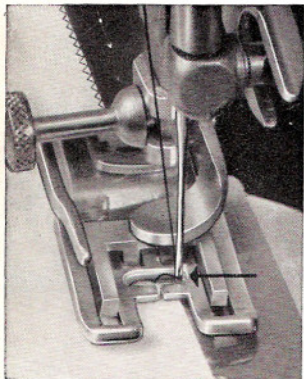

Fig. 15

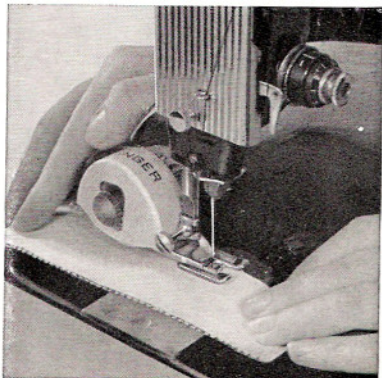

Fig. 14

Examples of Special Applications

Overedging Seams

In order to prevent the raw edges of material from fraying, a wide zigzag stitch with a long stitch length is used to finish the seam edges. The fabric should be fed under the zigzagger foot in such a way that the needle takes one stitch to the left into the fabric and the next stitch to the right beyond the raw edge into space as shown in **Fig. 15**. The left hand guides the material towards the attachment and the right hand guides it beyond the attachment as shown in **Fig. 14**. Be sure to trim the edges of the material neatly beforehand as shown in **Fig. 13**. Do not sew too rapidly, so that the overedged seam will be smooth and regular in appearance.