

Form K5866  
(552)

ILLUSTRATED  
**LIST OF PARTS**  
FOR  
**No. 221K4**  
**MACHINE**



\*\*

THE SINGER MANUFACTURING COMPANY

*Rights Reserved*

*Printed in Great Britain*

Form K5866

Illustrated  
List of Parts  
FOR  
No. 221K4 Machine

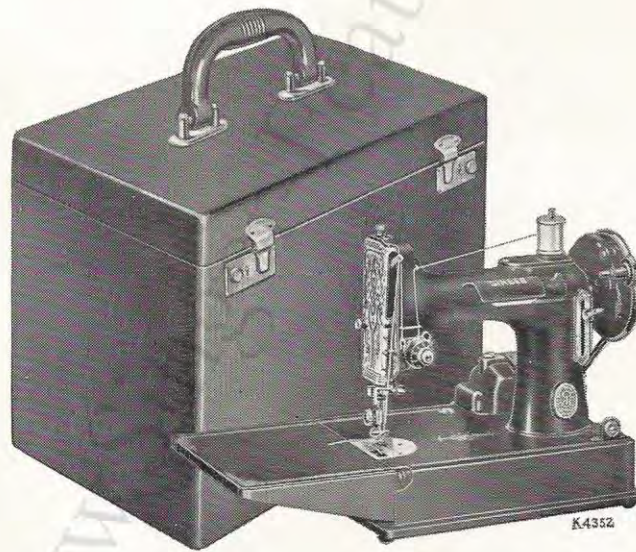

\*\* A Trade Mark of  
THE SINGER MANUFACTURING COMPANY

121170

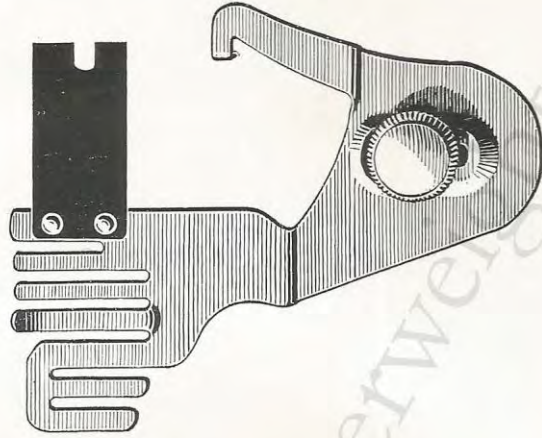

121547

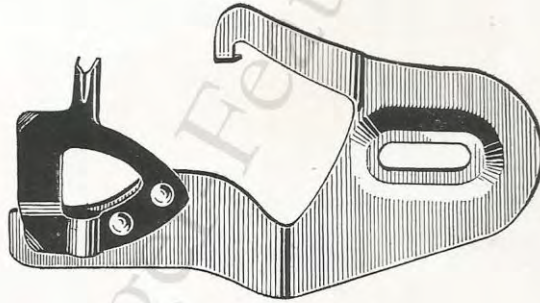

87589



96422



www.angel-featherweight.com

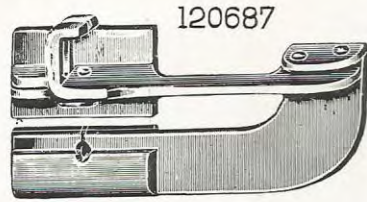

85893



36583

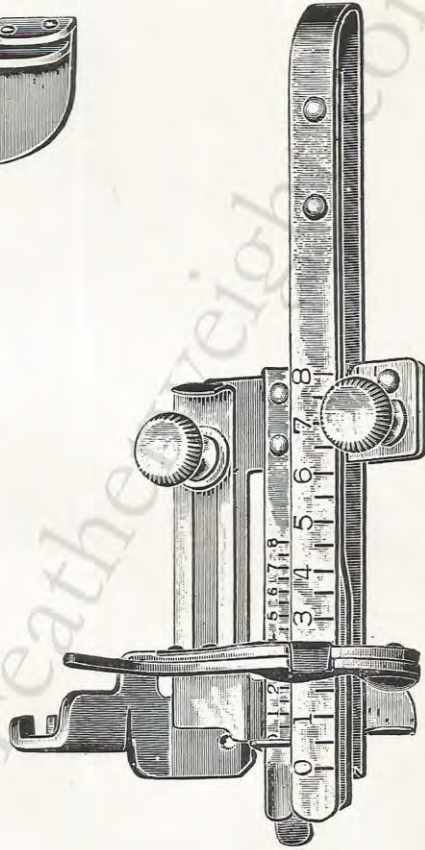

www.Singer-Feather-Reich.com

SS 528



96425



96426



96844



96427



96845



NW95



www.Singer-Featherweight.com

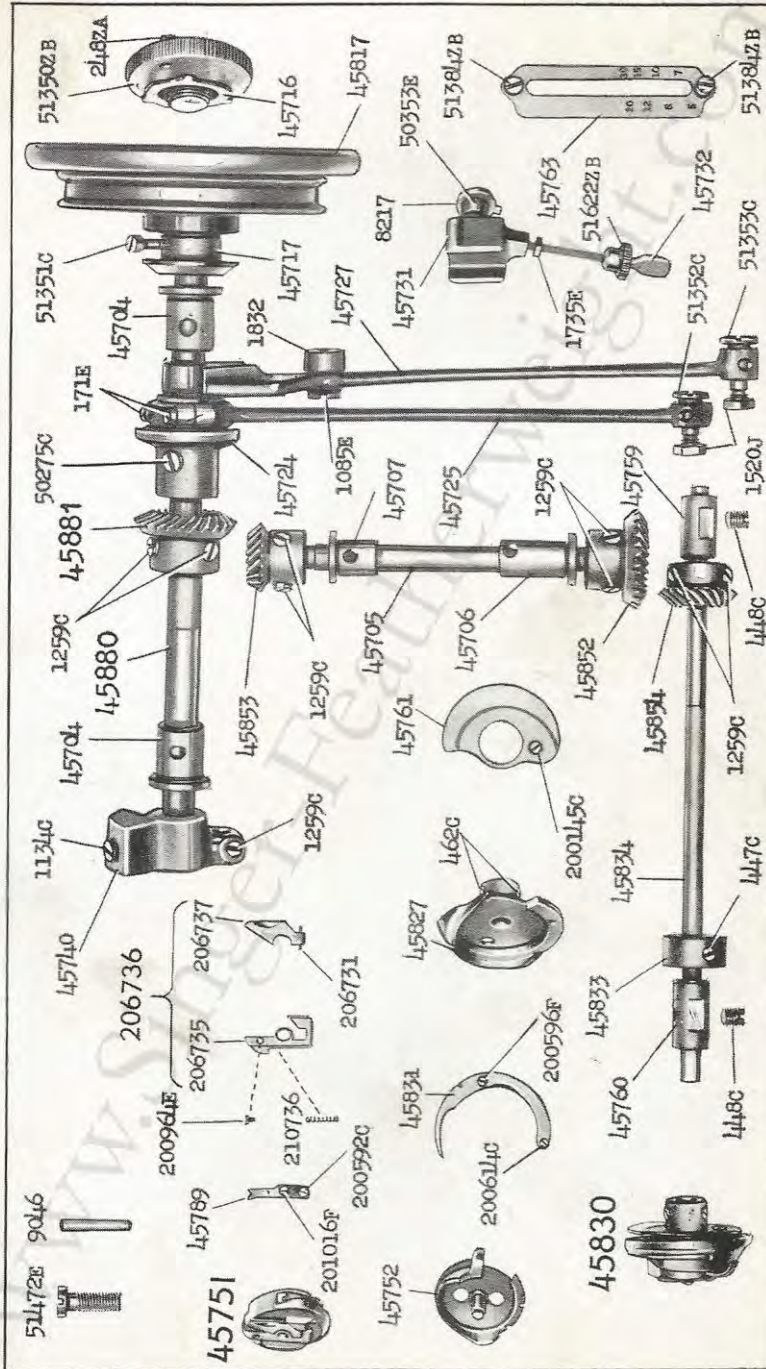

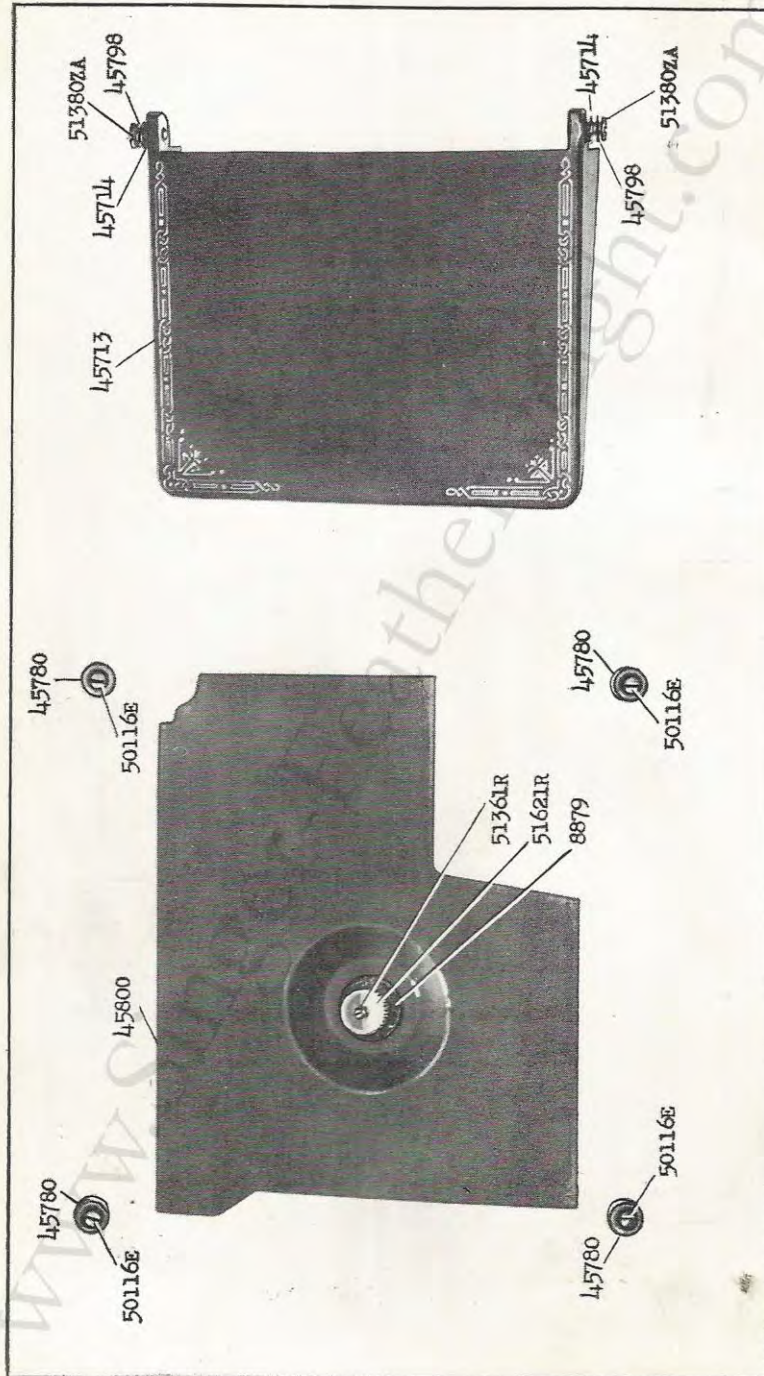



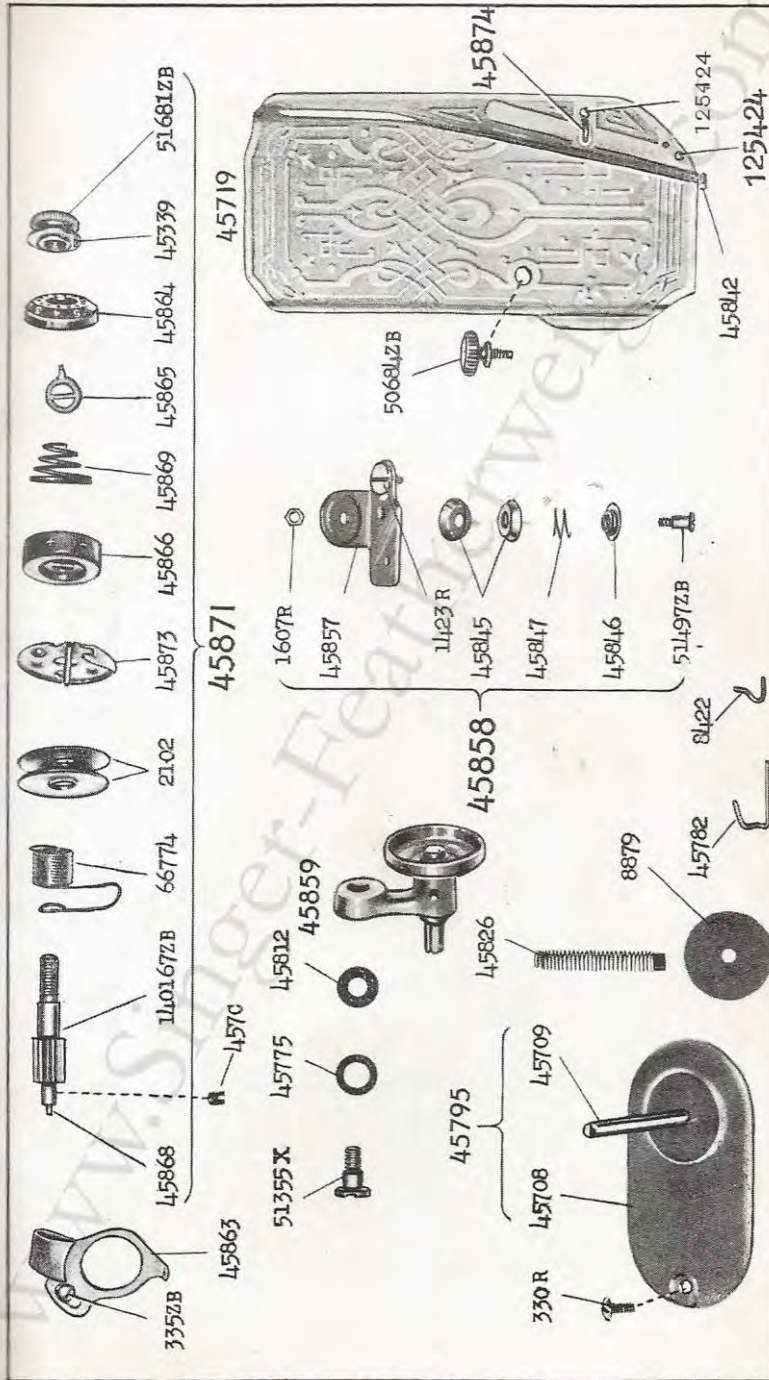

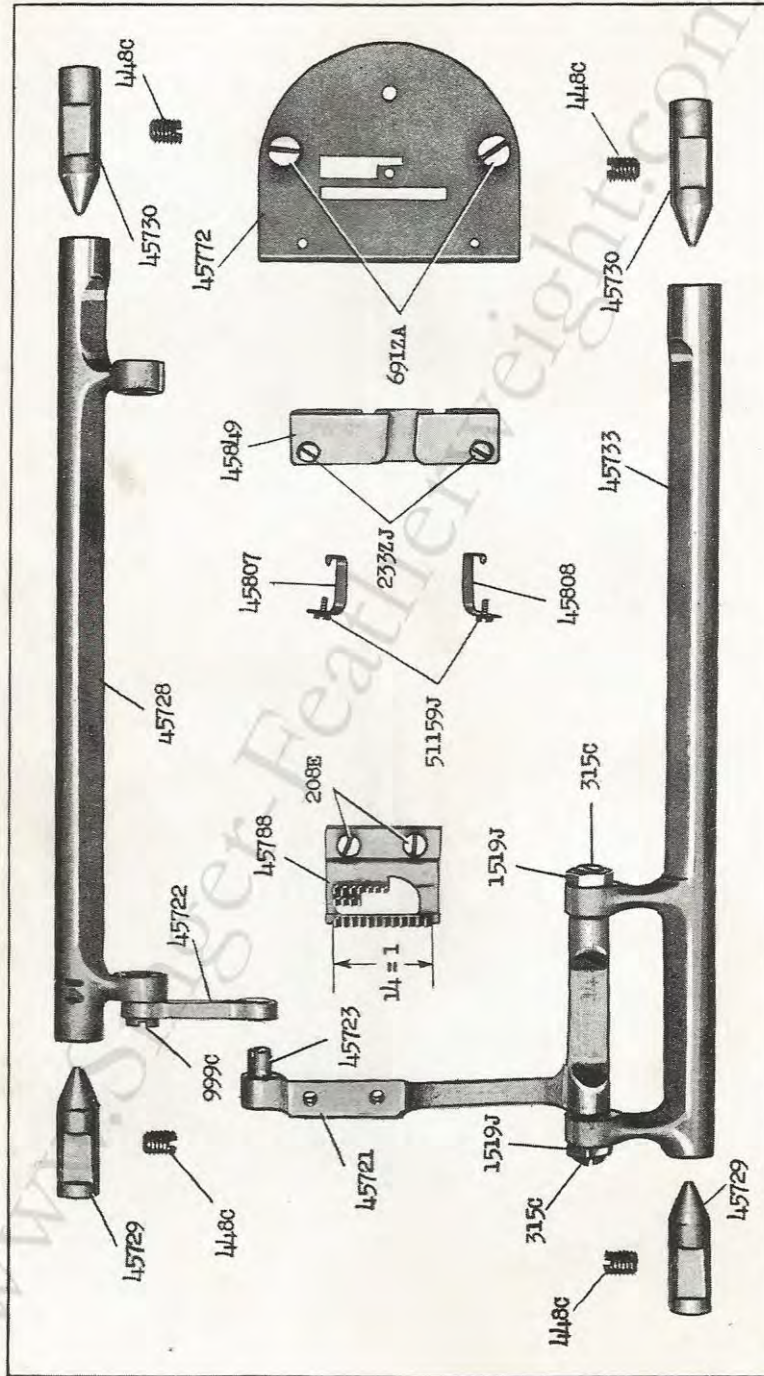

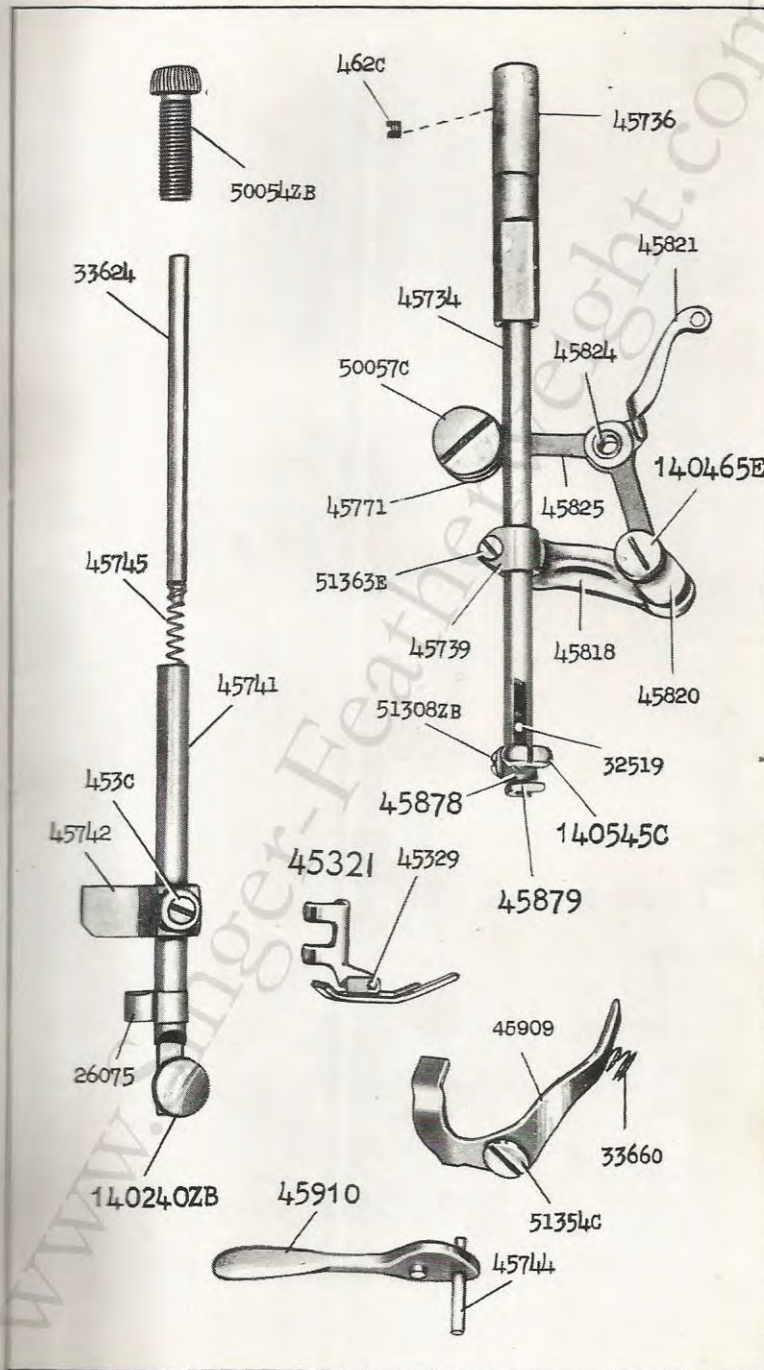

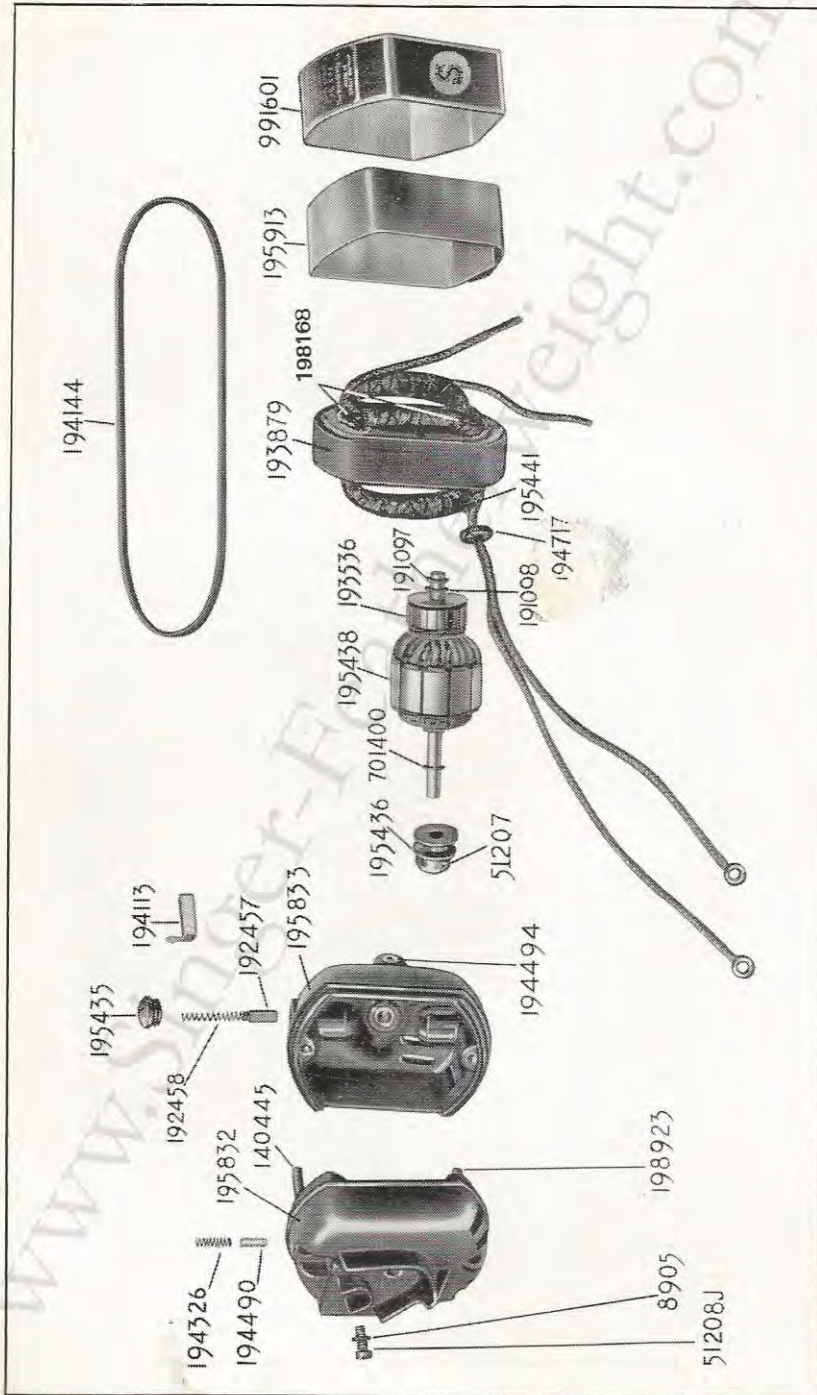

194577 194405 194403 820343 198414

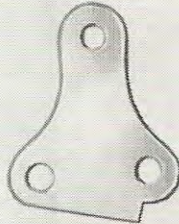

193907



931090



23258



192692



194774



140465



140100



140281



140333



964317



194514



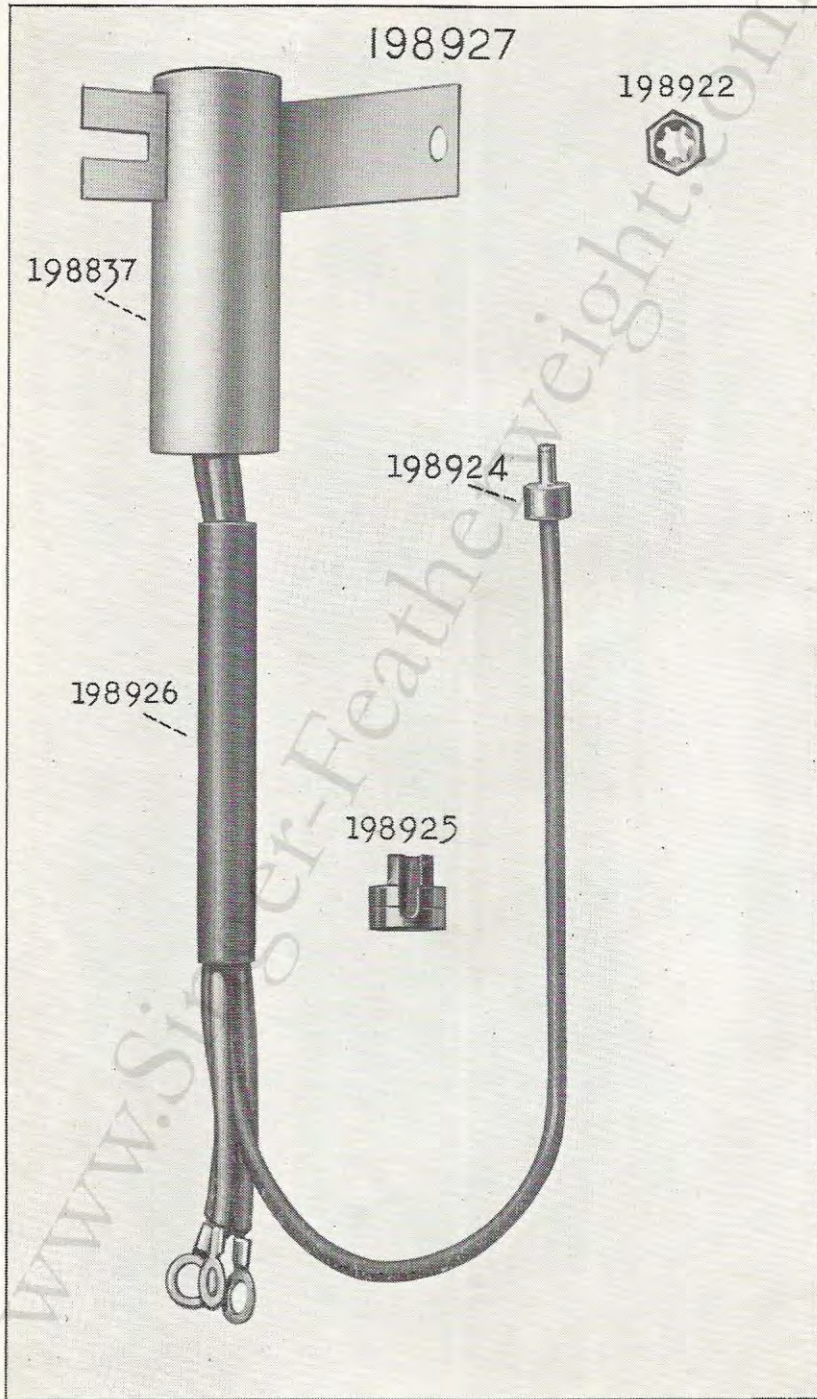

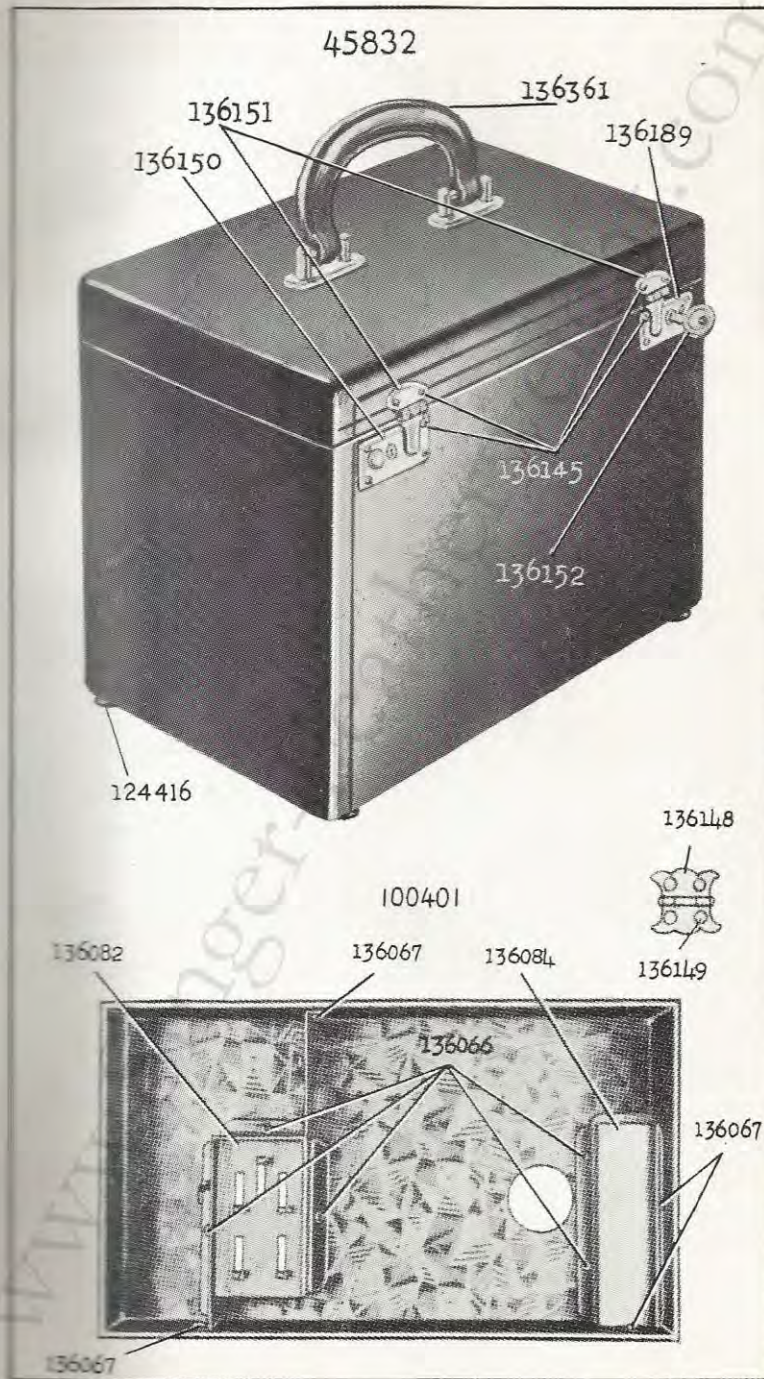

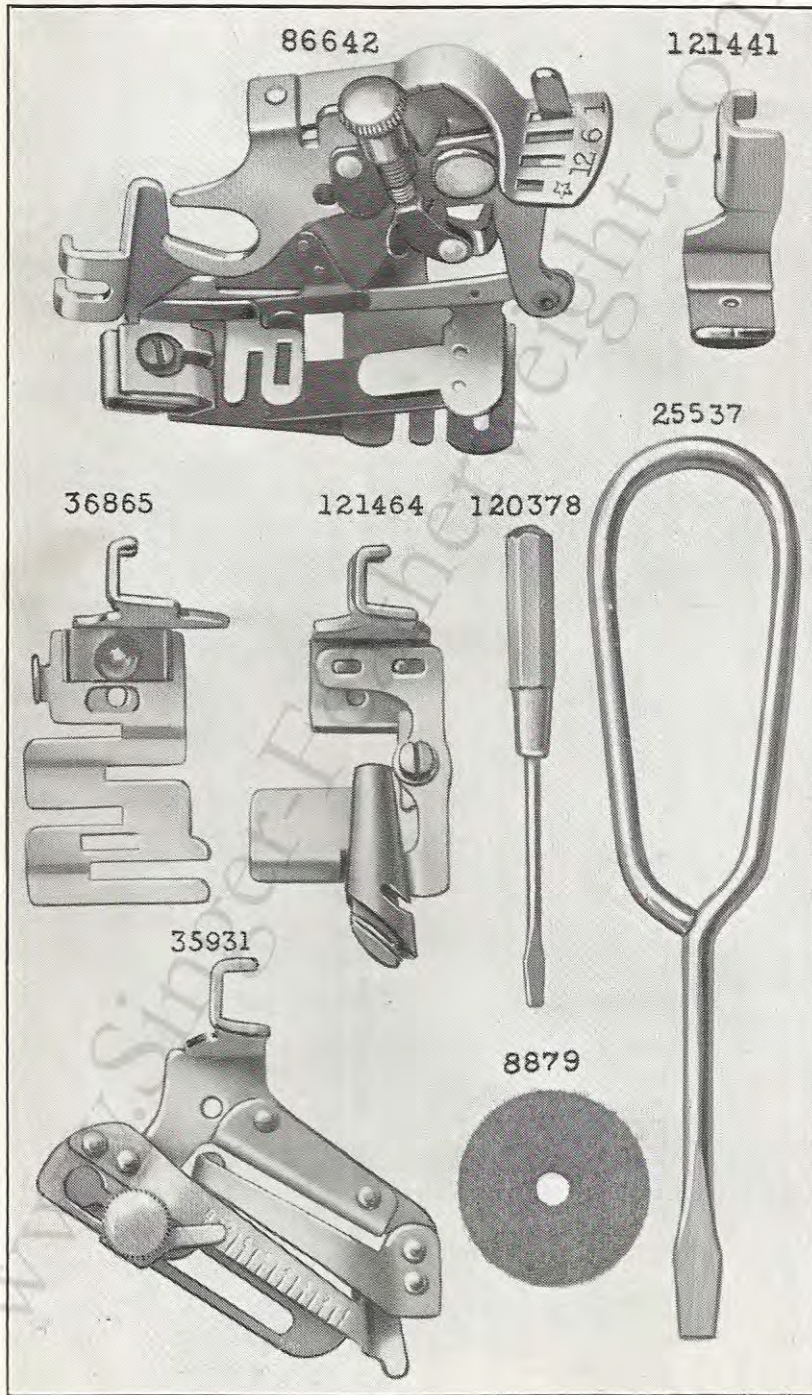



120914



120855

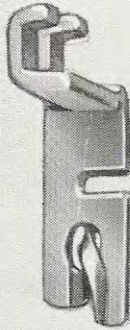

121094

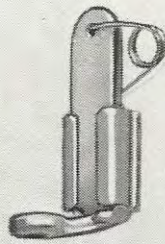

25539



121877

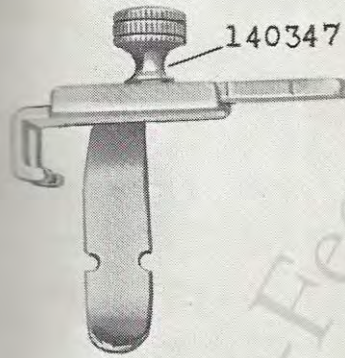

140347

125035



25525

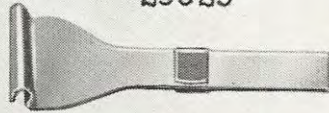

25527

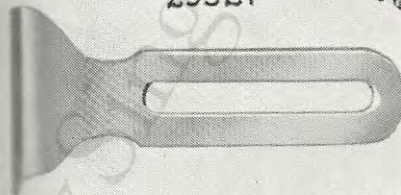

50053



35932

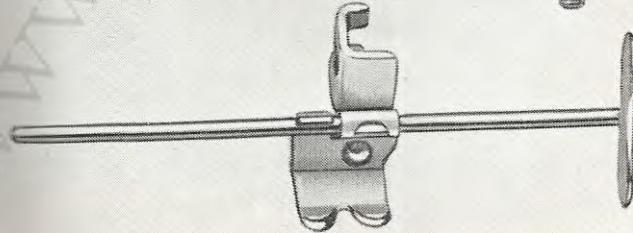

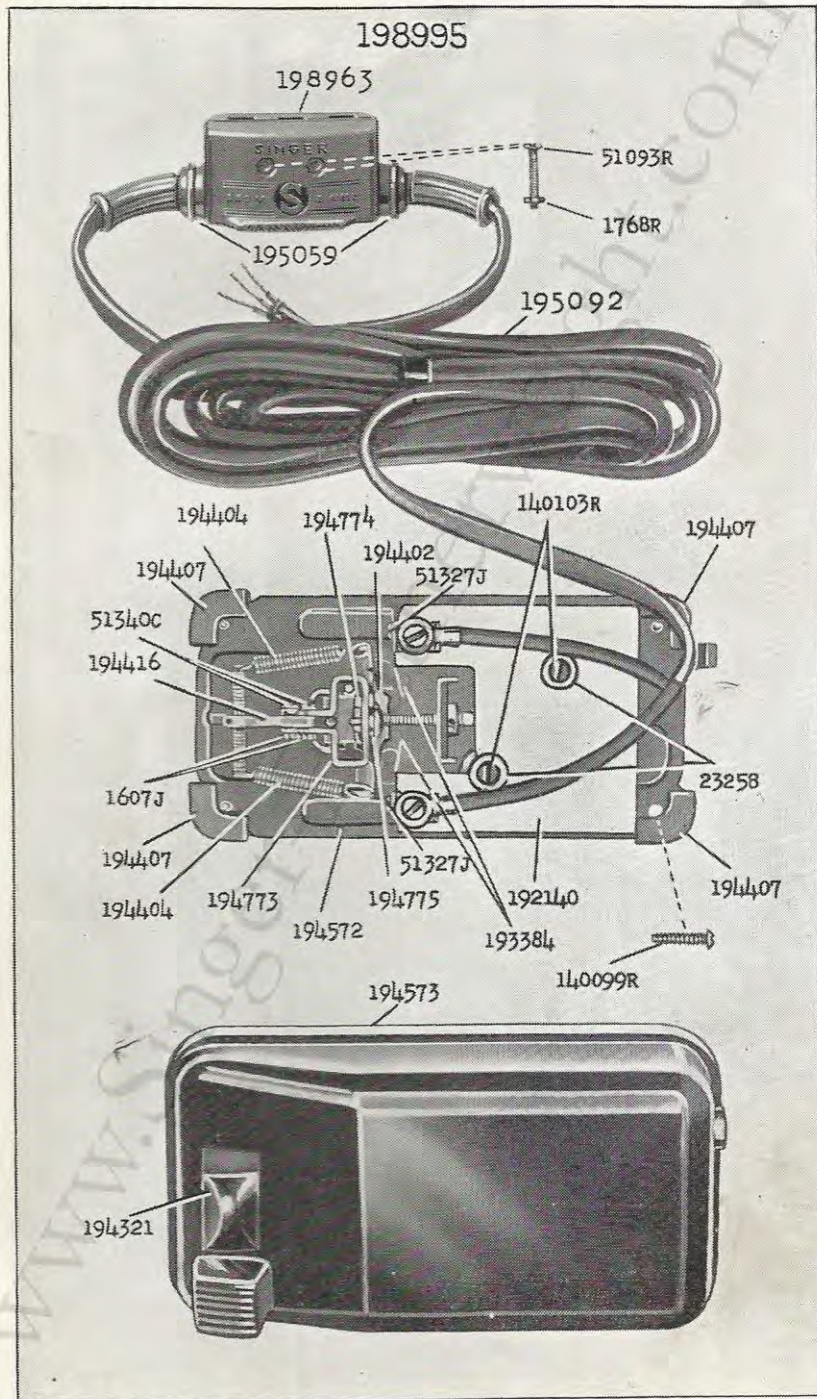

HALF SIZE  
199004

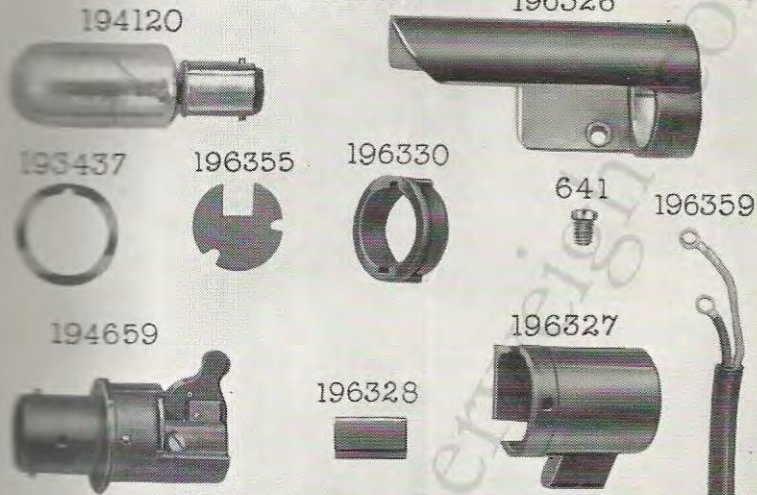

FULL SIZE

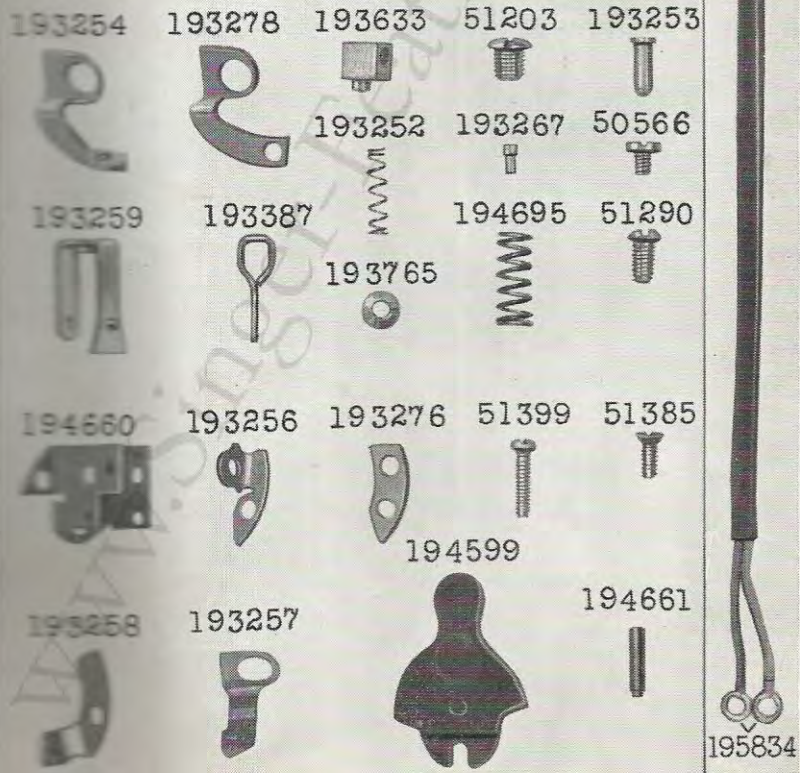

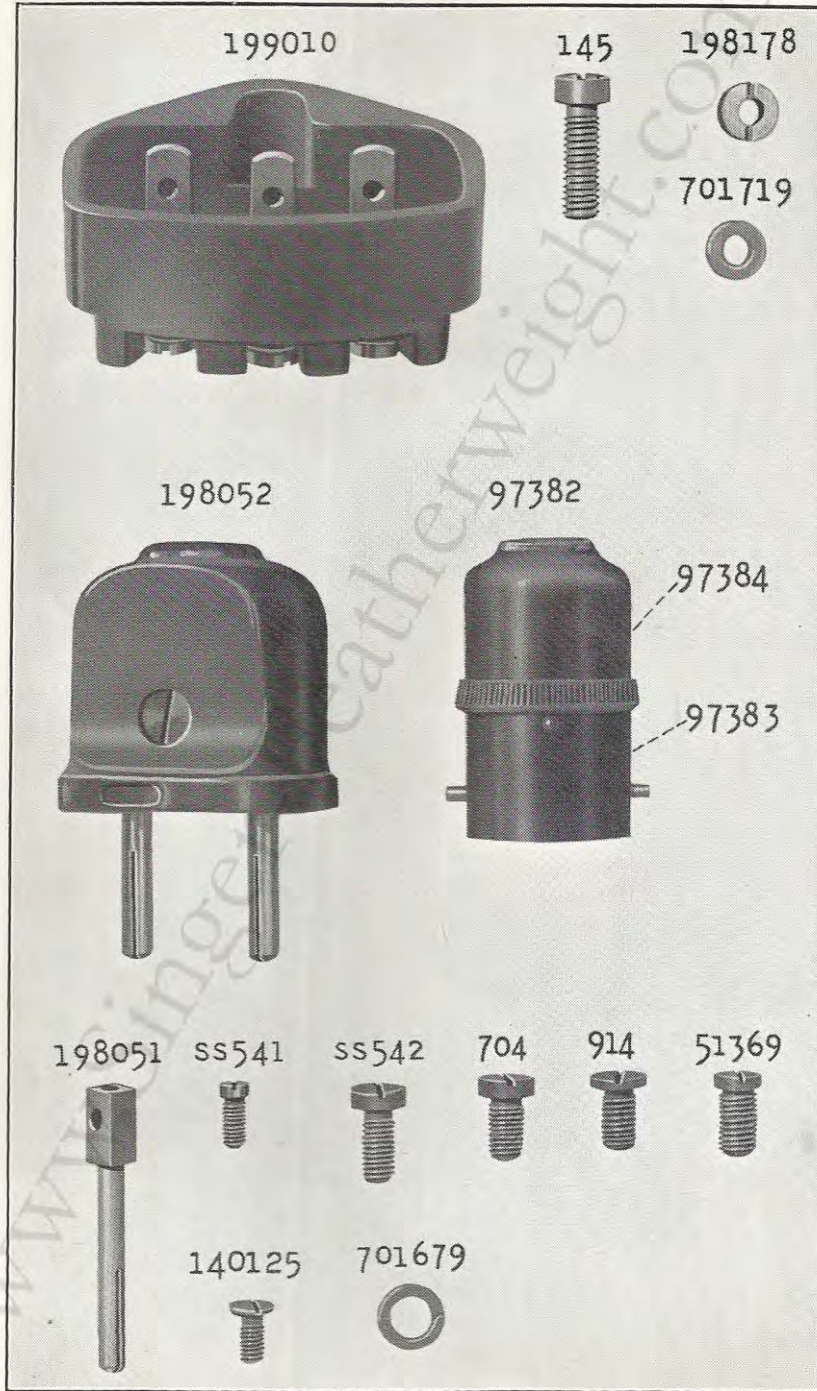

196358

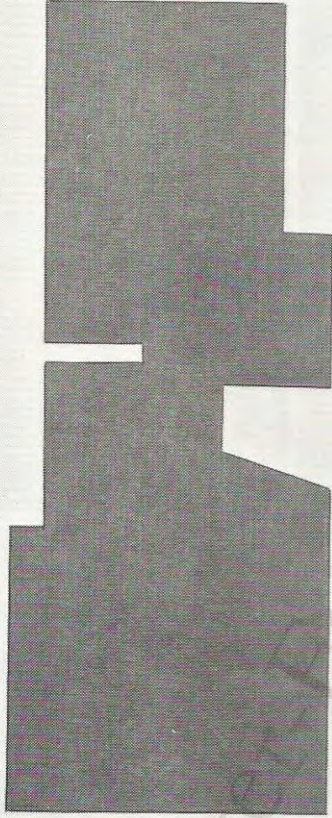

198954



196360



198960



www.SingaporeLeatherweight.com

196367

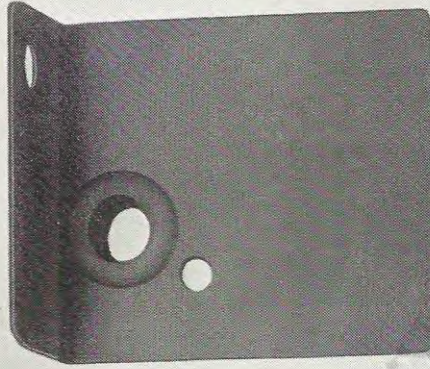

196342

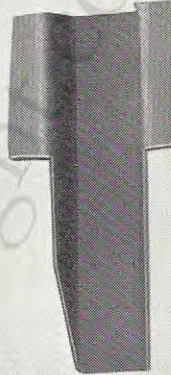

196354



964270



190328



196356

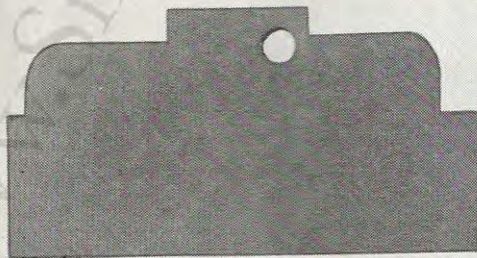

196363



190439



121632

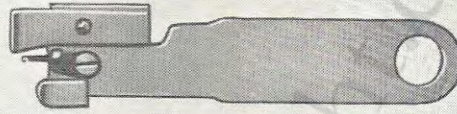

121631



140157



108002



45877



140545

45875



1036



45785

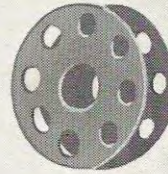

51354



LIST OF PARTS  
FOR  
No. 221K4 MACHINE

[www.Singer-Featherweight.com](http://www.Singer-Featherweight.com)



## CONTENTS

---

	Page
Attachments ... ..	47
Bobbin Winder Parts ... ..	46
Carrying Case ... ..	49
Machine Parts ... ..	31
Motor Parts ... ..	37
Numerical List of Parts ... ..	53
Singerlight ... ..	44

## INSTRUCTIONS FOR ORDERING

In ordering from this List, the prefix and affix letters with the part number **MUST BE** quoted exactly as they are shown in the first column.

A number always indicates the same part in whatever List it may appear, or for whatever machine.

The affix letters (where shown) indicate the style of finish, as follows :—

- A. Hardened, Polished, Nickel Plated and Buffed.
- A.A. Buffed and Chromium Plated.
- A.B. Hardened, Polished, Buffed and Chromium Plated.
- A.C. Brown Baking Enamel Finish.
- A.D. Grey Baking Enamel Finish.
- A.E. Hardened, Bright Rumbled and Nickel Plated.
- A.F. Hardened, Bright Rumbled and Nickel Plated, Bright Rumbled and Chromium Plated.
- A.J. Polished, Nickel Plated and Chromium Plated.
- A.K. Hardened, Polished, Nickel Plated and Chromium Plated.
- A.L. Heat Treated for Toughness.
  - B. Polished, Nickel Plated and Buffed.
  - C. Hardened only.
- C.R. Hardened and Merlized.
  - D. Polished only.
  - E. Soft, not Polished.
  - F. Hardened and Polished.
- F.J. Hardened, Polished and Nickel Plated.
- G. Bright Rumbled and Nickel Plated.
- H. Blued.
- J. Nickel Plated only.
- K. Hardened and Nickel Plated.
- L. Brass Plated.
- M. Oxidized.
- N. Japanned, Dull.
- P. Japanned, Bright.
- P.P. Wrinkle Finish.
- R. Merlized.
- S. Cadmium Plated.
- T. Copper Plated.
- T.A. Hardened, Polished, Copper and Nickel Plated and Buffed.
- T.B. Copper and Nickel Plated and Polished.
- T.J. Copper and Nickel Plated only.
- T.K. Hardened, Copper and Nickel Plated.
- T.L. Copper and Brass Plated.
- T.M. Copper Plated and Oxidized.
- U. Zinc Plated.
- V. Silver Plated.
- W. Polished and Nickel Plated.
- X. Black Oxide for Iron and Steel.
- X.C. Hardened and Black Oxide for Iron and Steel.
  - Y. Black Nickel Plated only.
  - Z. Chromium Plated.
- Z.A. Hardened, Polished, Nickel Plated, Buffed and Chromium Plated.
- Z.B. Polished, Nickel Plated, Buffed and Chromium Plated.
- Z.C. Hardened and Chromium Plated.
- Z.D. Polished and Chromium Plated.
- Z.G. Bright Rumbled, Nickel Plated, Bright Rumbled and Chromium Plated.
- Z.J. Nickel and Chromium Plated.
- Z.T. Copper and Chromium Plated.

*Parts marked with an asterisk (\*) are furnished only when the repairs are made at Factory.*

# PARTS COMPLETE

FOR

## MACHINE No. 221K4

**Portable Family Machine, Rotary Hook, Motor Driven and Singerlight.**

No.	Plate							
*45701	—	<b>Arm</b>	...	...	...	...	...	...
*45814	—	"	45701 with 45706, 45707 and two 45704	...	...	...	...	...

*NOTE.—Due to the accuracy required for gear alignment, Arm cannot be supplied separately and can only be sent as a unit, Arm and Bed assembled.*

9046	2525	<b>Arm Dowel Pin (2)</b>	...	...	...	...	...	...
51472e	2525	"	Screw (3)	...	...	...	...	...
45880	2525	"	Shaft (horizontal)	...	...	...	...	...
45886	—	"	" ( " )	45880 with 45740	...	...	...	...
45881	2525	"	" ( " )	Bevel Gear with 1259c and 140333c	...	...	...	...
1259c	2525	"	" ( " )	" " Set Screw	...	...	...	...
140333c	2538	"	" ( " )	" " Position Screw	...	...	...	...
45704	2525	"	" ( " )	Bushing	...	...	...	...
45705	2525	"	" (upright)	...	...	...	...	...
45852	2525	"	" ( " )	Bevel Gear (lower) with two 1259c	...	...	...	...
1259c	2525	"	" ( " )	" " ( " ) Set Screw	...	...	...	...
45853	2525	"	" ( " )	" " (upper) with two 1259c	...	...	...	...
1259c	2525	"	" ( " )	" " ( " ) Set Screw	...	...	...	...
45706	2525	"	" ( " )	Bushing (lower)	...	...	...	...
45707	2525	"	" ( " )	" (upper)	...	...	...	...
45708	2527	"	Top Cover	...	...	...	...	...
45795	2527	"	" " 45708 with 45709	...	...	...	...	...
330r	2527	"	" " Screw	...	...	...	...	...
45709	2527	"	" " Spool Pin	...	...	...	...	...
8879	2574	"	" " " Washer (cloth)	...	...	...	...	...
45817	2525	<b>Balance Wheel</b>	...	...	...	...	...	...
*108001	—	<b>Bed</b>	...	...	...	...	...	...
*108003	—	"	108001 with 45759, 45760 and two 448c	...	...	...	...	...

*NOTE.—Due to the accuracy required for gear alignment, Bed cannot be supplied separately and can only be sent as a unit, Arm and Bed assembled.*

45712	—	<b>Bed Cover Plate (bottom)</b>	...	...	...	...	...	...
45800	2526	"	" " ( " )	45712 with 45799	...	...	...	...
*45799	—	"	" " ( " )	Felt	...	...	...	...
51361r	2526	"	" " ( " )	Screw	...	...	...	...
51621r	2526	"	" " ( " )	" Thumb Nut	...	...	...	...
8879	2526	"	" " ( " )	" " Washer (cloth)	...	...	...	...

No.	Plate						
45780	2526	<b>Bed Cushion (rubber) (4)</b>	...	...	...	...	...
50116e	2526	" " Screw (4)	...	...	...	...	...
45713	2526	" Extension	...	...	...	...	...
51380r	2526	" " Hinge Screw (2)	...	...	...	...	...
45798	2526	" " " " Washer (2)	...	...	...	...	...
45714	2526	" " " " Friction Washer (2)	...	...	...	...	...
51350zb	2525	<b>Clamp Stop Motion Clamp Screw</b>	...	...	...	...	...
248za	2525	" " " " Stop Screw	...	...	...	...	...
45716	2525	" " " " Washer	...	...	...	...	...
45717	2525	" " " " Flanged Bushing	...	...	...	...	...
45765	—	" " " " " " 45717 with 51350zb	...	...	...	...	...
51351c	2525	" " " " " " Screw	...	...	...	...	...
*45718	—	<b>Face Plate</b>	...	...	...	...	...
45719	2527	" " 45718 with 45842 and 139615	...	...	...	...	...
50684zb	2527	" " Thumb Screw	...	...	...	...	...
45875	2590	" " Thread Guard (lower)	...	...	...	...	...
45842	2527	" " " " ( " ) 45875 with 125424	...	...	...	...	...
125424	2527	" " " " ( " ) Rivet	...	...	...	...	...
45874	2527	" " " " (upper)	...	...	...	...	...
139615	—	" " " " ( " ) 45874 with 125424	...	...	...	...	...
125424	2527	" " " " ( " ) Rivet	...	...	...	...	...
45721	2528	<b>Feed Bar</b>	...	...	...	...	...
45722	2528	" " Connecting Link	...	...	...	...	...
999c	2528	" " " " Hinge Screw	...	...	...	...	...
45723	2528	" " " " Stud	...	...	...	...	...
315c	2528	" " Screw Centre	...	...	...	...	...
15445	—	" " " " 315c with 1519r (2)	...	...	...	...	...
1519r	2528	" " " " Nut	...	...	...	...	...
45724	2525	" " Cam and Feed Lifting Eccentric with 50275c	...	...	...	...	...
50275c	2525	" " " " " " Set Screw	...	...	...	...	...
45788	2528	" " Dog, 12 teeth (14 teeth to the inch) for 45772	...	...	...	...	...
208al	2528	" " Screw (2)	...	...	...	...	...
45727	2525	" " Forked Connection	...	...	...	...	...
45754	—	" " " " 45727 with 1832	...	...	...	...	...
51353c	2525	" " " " Hinge Screw (eccentric)	...	...	...	...	...
1520j	2525	" " " " " " Nut	...	...	...	...	...
1832	2525	" " " " Roller with 1085e	...	...	...	...	...
1085e	2525	" " " " Screw Stud	...	...	...	...	...
45725	2525	" " Lifting Connecting Rod with 45726 and two 171al	...	...	...	...	...
*45726	—	" " " " Cap	...	...	...	...	...
171al	2525	" " " " " " Screw	...	...	...	...	...
51352c	2525	" " " " " " Hinge Screw (eccentric)	...	...	...	...	...
1520j	2525	" " " " " " " " Nut	...	...	...	...	...

## PARTS FOR No. 221K4 MACHINE

33

No.	Plate						
45728	2528	<b>Feed Lifting Rock Shaft</b>	...	...	...	...	...
45729	2528	" " " "	Centre (left)	...	...	...	...
448c	2525	" " " "	" ( " ) Set Screw	...	...	...	...
45730	2528	" " " "	" (right)	...	...	...	...
448c	2525	" " " "	" ( " ) Set Screw	...	...	...	...
45731	2525	" Regulator	...	...	...	...	...
50353e	2525	" " Hinge Screw	...	...	...	...	...
8217	2525	" " " "	Friction Washer	...	...	...	...
45732	2525	" Reversing Handle	...	...	...	...	...
45794	—	" " " "	45732 with 51622zb	...	...	...	...
1735e	2525	" " " "	Lock Nut	...	...	...	...
45733	2528	" Rock Shaft	...	...	...	...	...
45729	2528	" " " "	Centre (left)	...	...	...	...
448c	2525	" " " "	" ( " ) Set Screw	...	...	...	...
45730	2528	" " " "	" (right)	...	...	...	...
448c	2525	" " " "	" ( " ) Set Screw	...	...	...	...
45734	2529	<b>Needle Bar</b> (hollow) with 32519	...	...	...	...	...
45736	2529	" " Bushing (upper)	...	...	...	...	...
462c	2525	" " " "	" ( " ) Set Screw	...	...	...	...
45818	2529	" " Connecting Link	...	...	...	...	...
45819	—	" " " "	45818 with 45739	...	...	...	...
45739	2529	" " " "	Stud with 51363e	...	...	...	...
51363e	2529	" " " "	" Clamping Screw	...	...	...	...
45740	2525	" " Crank with 1036al and 1134al	...	...	...	...	...
1134al	2525	" " " "	Position Screw	...	...	...	...
45877	2590	" Clamp Body with 140545zc	...	...	...	...	...
45878	2529	" " " "	45877 with 51308zj	...	...	...	...
45879	2529	" " Gib and Thread Guard	...	...	...	...	...
51308zj	2529	" " Position Screw	...	...	...	...	...
140545zc	2590	" " Thumb Screw	...	...	...	...	...
32519	2529	" Stop Pin	...	...	...	...	...
45741	2529	<b>Presser Bar</b>	...	...	...	...	...
45742	2529	" " Guide Bracket with 453c	...	...	...	...	...
453c	2529	" " " "	Set Screw	...	...	...	...
45910	2529	" " Lifter	...	...	...	...	...
45744	2529	" " " "	Hinge Pin	...	...	...	...
45745	2529	" " Spring	...	...	...	...	...
45813	—	" " " "	45745 with 33624	...	...	...	...
45329	2529	<b>Presser Foot Hinge Pin</b>	...	...	...	...	...
45319	—	" " Plate	...	...	...	...	...
45320	—	" " Shank	...	...	...	...	...
45321	2529	<b>Presser Foot</b> (hinged), complete, Nos. 45319, 45320 and 45329	...	...	...	...	...
140240zb	2529	" " Thumb Screw	...	...	...	...	...

No.	Plate								
50054zb	2529	<b>Pressure Regulating Thumb Screw</b>	...	...	...				
33624	2529	"	"	"	"	Extension Pin	...		
45827	2525	<b>Rotating Hook</b>	with two 462al	...	...				
45829	—	"	"	45827	with 45752, 45761, 45831, 200145c, 200596f and 200614c				
45828	—	"	"	45827	with 45831, 200596f and 200614c (for Agents only)				
45830	2525	"	"		and Bobbin Case complete, Nos. 45751 and 45829				
45785	2590	"	"	Bobbin	...	...	...	...	...
*45750	—	"	"	"	Case	...	...	...	...
45751	2525	<b>Rotating Hook Bobbin Case</b> , complete, Nos. 45750, 45789, 200592c, 200964e, 201016f, 206736 and 210736	...	...	...				
45752	2525	<b>Rotating Hook Bobbin Case Base</b>	...	...	...				
206735	2525	"	"	"	"	Latch	...	...	...
206736	2525	"	"	"	"	206735 with 206731 and 206737			
206731	2525	"	"	"	"	Fulcrum Pin	...	...	...
206737	2525	"	"	"	"	Lever	...	...	...
210736	2525	"	"	"	"	Spring	...	...	...
200964e	2525	"	"	"	"	Stop Screw	...	...	...
45849	2528	"	"	"	"	Position Plate	...	...	...
45850	—	"	"	"	"	"	45849 with 45807, 45808 and two 51159j		
45807	2528	"	"	"	"	Position Plate Spring (back)	...	...	...
45808	2528	"	"	"	"	"	"	(front)	...
51159j	2528	"	"	"	"	"	"	Screw	...
233zj	2528	"	"	"	"	"	"	Screw (2)	...
45789	2525	"	"	"	"	Tension Spring	...	...	...
201016f	2525	"	"	"	"	"	"	Regulating Screw	...
200592c	2525	"	"	"	"	"	"	Screw	...
45833	2525	"	"	"	"	Collar and Counterbalance with 447c	...	...	...
447c	2525	"	"	"	"	Set Screw	...	...	...
45831	2525	"	"	Gib	...	...	...	...	...
200614c	2525	"	"	"	Hinge Screw	...	...	...	...
200596f	2525	"	"	"	Screw	...	...	...	...
462al	2525	"	"	"	Set Screw	...	...	...	...
45834	2525	"	"	Shaft	...	...	...	...	...
45854	2525	"	"	"	Bevel Gear with two 1259c	...	...	...	...
1259c	2525	"	"	"	"	Set Screw	...	...	...
45759	2525	"	"	"	Bushing (back)	...	...	...	...
448c	2525	"	"	"	"	( " ) Set Screw	...	...	...
45760	2525	"	"	"	"	(front)	...	...	...
448c	2525	"	"	"	"	( " ) Set Screw	...	...	...
45761	2525	"	"	Loop Guard	...	...	...	...	...
200145c	2525	"	"	"	"	Screw	...	...	...

No.	Plate						
45863	2527	<b>Slack Thread Regulator</b>	and Tension Thread Guide	...			
335zb	2527	"	" " " " " " " "	Screw			
45900	—	<b>Set of Mated Gears</b>	(upper shaft), complete, Nos. 45853 and 45881				
45901	—	<b>Set of Mated Gears</b>	(lower shaft), complete, Nos. 45852 and 45854				
45826	2527	<b>Spool Holder Spring</b>	...	...	...	...	...
45763	2525	<b>Stitch Indicator Plate</b>	...	...	...	...	...
51384zb	2525	"	" " " Screw (2)	...	...	...	...
51622zb	2525	"	Regulating Thumb Nut	...	...	...	...
2102	2527	<b>Tension Disc</b>	...	...	...	...	...
45866	2527	"	Indicator	...	...	...	...
45864	2527	"	" " Flange	...	...	...	...
45865	2527	"	" " " Stop Washer	...	...	...	...
51681zb	2527	"	Regulating Thumb Nut with 45339	...	...	...	...
45339	2527	"	" " " " Engaging Pin	...	...	...	...
45909	2529	"	Releasing Lever	...	...	...	...
51354c	2529	"	" " " Hinge Screw	...	...	...	...
33660	2529	"	" " " Spring	...	...	...	...
45868	2527	"	" " " Pin	...	...	...	...
45869	2527	"	Spring	...	...	...	...
140167zb	2527	"	Stud	...	...	...	...
45870	—	"	" " 140167zb with 51681zb	...	...	...	...
457c	2527	"	" " Set Screw	...	...	...	...
45871	2527	<b>Tension</b>	(graduated), complete, Nos. 45864 to 45866, 45868 to 45870, 45873, 66774 and two 2102	...	...	...	...
26075	2529	<b>Thread Cutter and Holder</b>	...	...	...	...	...
8422	2527	"	Guard (head of arm, upper)	...	...	...	...
45782	2527	"	" " (head of arm, lower)	...	...	...	...
45820	2529	"	Take-up Crank	...	...	...	...
1036al	2590	"	" " " Set Screw	...	...	...	...
*45821	2529	"	" " Lever	...	...	...	...
45822	—	"	" " complete, Nos. 45821, 45824 and 45825				
45823	—	"	" " 45822 with 45771, 45819, 45820, 50057c and 140465e				
140465e	2529	"	" " " Cap Screw	...	...	...	...
*45824	2529	"	" " " Hinge Stud	...	...	...	...
*45825	2529	"	" " " Link	...	...	...	...
50057c	2529	"	" " " " Hinge Screw	...	...	...	...
45771	2529	"	" " " " " Washer	...	...	...	...
66774	2527	"	" " Spring	...	...	...	...
45873	2527	"	" " " Thread Guard	...	...	...	...
45772	2528	<b>Throat Plate</b>	for 45788	...	...	...	...
691za	2528	"	" " Screw (2)	...	...	...	...

## SERIES C.A.K. 6 MOTORS

Volts.	Cycles.	Amperes.	Motor Catalogue No.
12	D.C.	4.2	C.A.K. 6-1
32	D.C.	1.0	C.A.K. 6-3
50	D.C. & 25 to 75	.7	C.A.K. 6-5
95-100	D.C. & 25 to 75	.4	C.A.K. 6-6
100-110	D.C. & 25 to 75	.4	C.A.K. 6-7
110-120	D.C. & 25 to 75	.4	C.A.K. 6-8
150-165	D.C. & 25 to 75	.35	C.A.K. 6-9
190-210	D.C. & 25 to 75	.25	C.A.K. 6-10
210-230	D.C. & 25 to 75	.25	C.A.K. 6-11
230-250	D.C. & 25 to 75	.25	C.A.K. 6-12
120-130	D.C. & 25 to 75	.35	C.A.K. 6-14
130-145	D.C. & 25 to 75	.35	C.A.K. 6-15



## Motor Parts

No.	Plate							
195487	—	Armature, complete, for	C.A.K. 6-3 Motor	...	...	...	...	...
195725	—	"	"	"	C.A.K. 6-3 S.I. Motor	...	...	...
195488	—	"	"	"	C.A.K. 6-5 Motor	...	...	...
195726	—	"	"	"	C.A.K. 6-5 S.I. Motor	...	...	...
195489	—	"	"	"	C.A.K. 6-6 Motor	...	...	...
195727	—	"	"	"	C.A.K. 6-6 S.I. Motor	...	...	...
195437	—	"	"	"	C.A.K. 6-7 Motor	...	...	...
195728	—	"	"	"	C.A.K. 6-7 S.I. Motor	...	...	...
195491	—	"	"	"	C.A.K. 6-8 Motor	...	...	...
195729	—	"	"	"	C.A.K. 6-8 S.I. Motor	...	...	...
195493	—	"	"	"	C.A.K. 6-9 Motor	...	...	...
195730	—	"	"	"	C.A.K. 6-9 S.I. Motor	...	...	...
195496	—	"	"	"	C.A.K. 6-10 Motor	...	...	...
195731	—	"	"	"	C.A.K. 6-10 S.I. Motor	...	...	...
195438	2535	"	"	"	C.A.K. 6-11 Motor	...	...	...
195732	—	"	"	"	C.A.K. 6-11 S.I. Motor	...	...	...
195868	—	"	"	"	C.A.K. 6-12 Motor	...	...	...
195733	—	"	"	"	C.A.K. 6-12 S.I. Motor	...	...	...
195518	—	"	"	"	C.A.K. 6-14 Motor	...	...	...
195734	—	"	"	"	C.A.K. 6-14 S.I. Motor	...	...	...
195492	—	"	"	"	C.A.K. 6-15 Motor	...	...	...
195735	—	"	"	"	C.A.K. 6-15 S.I. Motor	...	...	...
191097	2535	Armature Shaft Thrust Washer	(phenolic)	...	...	...	...	...
191098	2535	"	"	"	"	(phenolic)	...	...
701400	2535	"	"	"	"	(pulley end) (phenolic)	...	...
194144	2535	Belt (moulded)	...	...	...	...	...	...
192457	2535	Brush (carbon, $\frac{7}{32}$ " square)	...	...	...	...	...	...
195435	2535	Brush Cap	...	...	...	...	...	...
194113	2535	" Holder Tube	...	...	...	...	...	...
192458	2535	" Spring	...	...	...	...	...	...
193536	2535	Commutator, complete	...	...	...	...	...	...
193907	2538	" Oil Sling	...	...	...	...	...	...
195833	2535	End Cover (commutator end)	...	...	...	...	...	...
195832	2535	" " (pulley end)	...	...	...	...	...	...
140445	2535	" " Fastening Screw	(upper)	...	...	...	...	...
198923	2535	" " " "	(lower) for 198927	...	...	...	...	...

No.	Plate	
195465	—	Field Coils, assembled, for 195464 ... ..
193879	2535	" Core, complete ... ..
195464	—	" " with Coils, No. 195465, complete, for C.A.K. 6-3 Motor
195747	—	" Coils, assembled, for 195736 ... ..
195736	—	" Core with Coils, No. 195747, complete, for C.A.K. 6-3 S.I. Motor
195468	—	" Coils, assembled, for 195467 ... ..
195467	—	" Core with Coils, No. 195468, complete, for C.A.K. 6-5 Motor
195748	—	" Coils, assembled, for 195737 ... ..
195737	—	" Core with Coils, No. 195748, complete, for C.A.K. 6-5 S.I. Motor
195470	—	" Coils, assembled, for 195469 ... ..
195469	—	" Core with Coils, No. 195470, complete, for C.A.K. 6-6 Motor
195749	—	" Coils, assembled, for 195738 ... ..
195738	—	" Core with Coils No. 195749, complete, for C.A.K. 6-6 S.I. Motor
195440	—	" Coils, assembled, for 195439 ... ..
195439	—	" Core with Coils, No. 195440, complete, for C.A.K. 6-7 Motor
195750	—	" Coils, assembled, for 195739 ... ..
195739	—	" Core with Coils, No. 195750, complete, for C.A.K. 6-7 S.I. Motor
195474	—	" Coils, assembled, for 195473 ... ..
195473	—	" Core with Coils, No. 195474, complete, for C.A.K. 6-8 Motor
195751	—	" Coils, assembled, for 195740 ... ..
195740	—	" Core with Coils, No. 195751, complete, for C.A.K. 6-8 S.I. Motor
195478	—	" Coils, assembled, for 195477 ... ..
195477	—	" Core with Coils, No. 195478, complete, for C.A.K. 6-9 Motor
195752	—	" Coils, assembled, for 195741 ... ..
195741	—	" Core with Coils, No. 195752, complete, for C.A.K. 6-9 S.I. Motor
195484	—	" Coils, assembled, for 195483 ... ..
195483	—	" Core with Coils, No. 195484, complete, for C.A.K. 6-10 Motor
195753	—	" Coils, assembled, for 195742 ... ..
195742	—	" Core with Coils, No. 195753, complete for C.A.K. 6-10 S.I. Motor
195442	—	" Coils, assembled, for 195441 ... ..
195441	2535	" Core with Coils, No. 195442, complete, for C.A.K. 6-11 Motor
195754	—	" Coils, assembled, for 195743 ... ..
195743	—	" Core with Coils, No. 195754, complete, for C.A.K. 6-11 S.I. Motor
195482	—	" Coils, assembled, for 195481 ... ..

MOTOR PARTS

No.	Plate	
195481	—	Field Core with Coils, No. 195482, complete, for C.A.K. 6-12 Motor
195755	—	" Coils, assembled, for 195744 ... ..
195744	—	" Core with Coils, No. 195755, complete, for C.A.K. 6-12 S.I. Motor
195520	—	" Coils, assembled, for 195519 ... ..
195519	—	" Core with Coils, No. 195520, complete, for C.A.K. 6-14 Motor
195756	—	" Coils, assembled, for 195745 ... ..
195745	—	" Core with Coils, No. 195756, complete, for C.A.K. 6-14 S.I. Motor
195476	—	" Coils, assembled, for 195475 ... ..
195475	—	" Core with Coils, No. 195476, complete, for C.A.K. 6-15 Motor
195757	—	" Coils, assembled, for 195746 ... ..
195746	—	" Core with Coils, No. 195757, complete, for C.A.K. 6-15 S.I. Motor
820343	2538	" Coil Insulation ... ..
196360	2588	" " Lead Insulating Sleeve ... ..
194717	2535	" " " Strain Relief ... ..
198168	2535	" " Retainer ... ..
†991601	2535	" Core Shield and Nameplate ... ..
195913	2535	" " " " Insulation ... ..

† When ordering, state motor with which it is to be used.

195436	2535	Motor Pulley ... ..
51207r	2535	" " Set Screw ... ..
51208r	2535	" Screw ... ..
8905	2535	" " Washer ... ..
194326	2535	Oil Lubricating Spring ... ..
194494	2535	" " Tube ... ..
194490	2535	" " Wick ... ..
*195049	—	Three-pin Terminal Body (male half) ... ..
195048	—	" " " " ( " " ) 195049 with three 195050
*195051	—	" " " " ( " " ) Contact Prong ... ..
*195050	—	" " " " ( " " ) " " 195051 with 195052
*195052	—	" " " " ( " " ) " " Screw Post
198178	2587	" " " " ( " " ) Terminal Post Nut ... ..
701719	2587	" " " " ( " " ) " " Washer ... ..
199010	2587	Three-pin Terminal Body (male half), complete, Nos. 195048, three each 198178 and 701719 ... ..
145r	2587	Three-pin Terminal Body (male half) Screw ... ..

## MOTOR PARTS

No.	Plate						
196354	2589	Three-pin Terminal Box Cover	...	...	...	...	...
196357	—	" " " "	"	"	"	196354 with 196356	...
196356	2589	" " " "	"	"	"	Insulating Lining (leatheroid)	...
51369r	2587	" " " "	"	"	"	Screw (small)	...
704r	2587	" " " "	"	"	"	" (large)	...
190328	2589	" " " "	"	"	"	Bushing (rubber) for Singerlight and Suppressor Leads	...
964270	2589	" " " "	"	"	"	Bushing (rubber) for Motor Leads	...
196358	2588	" " " "	"	"	"	Insulation (leatheroid)	...
190439	2590	Tube filled with Singer Lubricant for Electric Motors	...	...	...	...	...
190613	—	" 190439 with 190612	...	...	...	...	...
190612	—	" Carton (paper)	...	...	...	...	...

## ELECTRICAL FITTINGS

No.	Plate						
196342	2589	Arm Lead Guard	...	...	...	...	...
196367	2589	Bed Lead Guard with 196363	...	...	...	...	...
196363	2589	" " " Bushing	...	...	...	...	...
914r	2587	" " " Fastening Screw	...	...	...	...	...
701679	2587	" " " " " Washer	...	...	...	...	...
196341	—	Snap-on Switch Hole Plug Button	...	...	...	...	...

## PLUGS

No.	Plate						
198052	2587	Two-pin Plug, complete, Nos. SS542, 193403, 193404, two each SS541 and 198051, for Norway and V.D.E.	...	...	...	...	...
193403	—	Two-pin Plug Body (upper half)	...	...	...	...	...
193404	—	" " " (lower half) with insert	...	...	...	...	...
SS542	2587	" " " Fastening Screw	...	...	...	...	...
198051	2587	" " Contact Pin	...	...	...	...	...
SS541	2587	" " " " Screw	...	...	...	...	...
97382	2587	Bayonet Plug, complete, Nos. 97383 and 97384, for Great Britain and Australia	...	...	...	...	...
97383	2587	" Plug Body	...	...	...	...	...
97384	2587	" " Cover	...	...	...	...	...

## FOOT CONTROLLERS (Bakelite)

No.	Plate	
198995	2582	Controller, complete, for 32 to 55 volts, A.C. or D.C. Motor, Nos. 194321, 194569, 194573, 195092, 899287, two 964317, four each 140099x and 194407 ... ..
(Great Britain and Australia)		
198995	—	Controller, complete, for 32 to 55 volts, A.C. or D.C. Motor, Nos. 194321, 194569, 194573, 199014, 899287, two 964317, four each 140099x and 194407 ... ..
(Norway and V.D.E.)		
198995	—	Controller, complete, for 32 to 55 volts, A.C. or D.C. Motor, Nos. 194321, 194569, 194573, 199014, 899287, two 964317, four each 140099x and 194407 ... ..
(Denmark and Switzerland)		
198996	—	Controller, complete, for 95 to 145 volts, A.C. or D.C. Motor, Nos. 194321, 194570, 194573, 195092, 199023, two 964317, four each 140099x and 194407 ... ..
(Great Britain and Australia)		
198996	—	Controller, complete, for 95 to 145 volts, A.C. or D.C. Motor, Nos. 194321, 194570, 194573, 199014, 199023, two 964317, four each 140099x and 194407 ... ..
(Norway and V.D.E.)		
198996	—	Controller, complete, for 95 to 145 volts, A.C. or D.C. Motor, Nos. 194321, 194570, 194573, 199014, 899287, two 964317, four each 140099x and 194407 ... ..
(Denmark and Switzerland)		
198997	—	Controller, complete, for 150 to 250 volts, A.C. or D.C. Motor, Nos. 194321, 194571, 194573, 195092, 199024, two 964317, four each 140099x and 194407 ... ..
(Great Britain and Australia)		
198997	—	Controller, complete, for 150 to 250 volts, A.C. or D.C. Motor, Nos. 194321, 194571, 194573, 199014, 199024, two 964317, four each 140099x and 194407 ... ..
(Norway and V.D.E.)		
198997	—	Controller, complete, for 150 to 250 volts, A.C. or D.C. Motor, Nos. 194321, 194571, 194573, 199014, 199024, two 964317, four each 140099x and 194407 ... ..
(Denmark and Switzerland)		
194572	2582	Controller Base with two 194419 ... ..
194569	—	" " 194572 with 192211, 194418, 194774, 194775 two each 23258, 140100x, 140103x, 194404, 194514 and 931090 ... ..
194570	—	Controller Base 194572 with 192140, 194418, 194774, 194775, two each 23258, 140100x, 140103x, 194404, 194514 and 931090
194571	—	Controller Base 194572 with 192141, 194418, 194774, 194775, two each 23258, 140100x, 140103x, 194404, 194514 and 931090
194407	2582	Controller Base Cushion (rubber) ... ..
140099x	2582	" " Screw ... ..
194573	2582	" Cover ... ..
194321	2582	" Foot Pedal ... ..
195096	—	" Lead Cord (long) 8', for 195092 ... ..
*195094	—	" " " (short) 3' 10", for 195093 ... ..
195093	—	" " " 3' 10", complete, Nos. 194577, 194604, 195094 and two 195834 for 195092 ... ..

No.	Plate	
195092	2582	Controller Lead Cord, complete, from supply socket to three-pin terminal and controller, Nos. 195093, 195096, 198963 and Plug, for 198995 to 198997 for Great Britain and Australia ...
199017	—	Controller Lead Cord (long) 8', for 199014 ...
199015	—	" " " (short) 3' 10", for 199016 ...
199016	—	" " " 3' 10", complete, Nos. 194577, 194604, 199015 and two 195834 for 199014 ...
199014	—	Controller Lead Cord, complete, from supply socket to three-pin terminal and controller, Nos. 198999, 199016, 199017 and Plug, for 198995 to 198997, for Norway, V.D.E., Denmark and Switzerland ...
194577	2538	Controller Lead Cord Insulating Sleeve $2\frac{1}{16}$ " long ...
*194604	—	" " Insulating Sleeve $3\frac{3}{8}$ " long ...
195834	2583	" " Terminal Eyelet ...
192211	—	Controller Resistance Unit, 32 to 55 volts ...
192140	2582	" " " 95 to 145 volts ...
192141	—	" " " 150 to 250 volts ...
194774	2582	" " " Adjusting Nut ...
194775	2582	" " " " Lock Spring ...
194403	2538	" " " Bell Crank for 194416 ...
194416	2582	" " " " complete, Nos. 194405 and two 194403 ...
51340c	2582	Controller Resistance Unit Bell Crank Hinge Screw ...
1607j	2527	" " " " " " Nut ...
194404	2582	" " " " " Spring ...
194402	2582	" " " " " Bracket ...
140100x	2538	" " " " " Screw ...
194418	—	Controller Resistance Unit Bell Crank Spring Bracket 194402 with 194416, 194773, two each 1607j and 51340c ...
194514	2538	Controller Resistance Unit Bell Crank Spring Bracket Screw Insulating Disc ...
194405	2538	Controller Resistance Unit Bell Crank Spring Position Pin ...
194419	—	" " " Insert Nut (brass) ...
140103x	2582	" " " Screw ...
931090	2538	" " " Washer (asbestos) ...
23258	2538	" " " " (steel) ...
193384	2582	" " " Short Circuiting Contact (2) ...
51327j	2582	" " " " " Screw (2) ...
194773	2582	" " " Yoke ...
51340c	2582	" " " Hinge Screw ...
1607j	2527	" " " " " Nut ...
*899287	—	Name Plate for 198995 ...
*199023	—	" " " 198996 ...
*199024	—	" " " 198997 ...
964317	2538	" " Drive Screw ...

FOOT CONTROLLERS

43

No.	Plate	
198970	—	Three-pin Terminal (female half) Housing (lower) with three 195058
198968	—	" " ( " " ) " ( " ) 198970 with three each 140125 and 195057
*195057	—	Three-pin Terminal (female half) Housing (lower) Contact Prong
*195058	—	" " ( " " ) " ( " ) Insert ...
140125	2587	" " ( " " ) " ( " ) Lead Screw...
198967	—	" " ( " " ) " (upper) ...
198954	2588	" " ( " " ) " Protection Sleeve (flat, flexible)
51093x	2582	" " ( " " ) " Screw ...
1768x	2582	" " ( " " ) " " Nut ...
195059	2582	" " ( " " ) " Snap Ring ...
198963	2582	Three-pin Terminal (female half), complete, Nos. 198967, 198968, two each 1768x, 51093x, 195059 and 198954 for 195092 ...
199002	—	Three-pin Terminal (female half) Housing (lower) with three 195058
199001	—	" " ( " " ) " ( " ) 199002 with three each 140125 and 195057
199000	—	Three-pin Terminal (female half) Housing (upper) ...
198960	2588	" " ( " " ) " Protection Sleeve (round, flexible)
198999	—	Three-pin Terminal (female half), complete, Nos. 199000, 199001, two each 1768x, 51093x, 195059 and 198960 for 199014 ...

RADIO INTERFERENCE SUPPRESSOR

No.	Plate	
198924	2539	Ground Lead Terminal Plug ...
198925	2539	Insulating Plug ...
198926	2539	Lead Insulating Tubing ...
198414	2538	" Terminal Clip ...
198837	2539	Radio Interference Suppressor only ...
198922	2539	" " " Pal Nut ...
198838	—	" " " Nos. 198837, 198924, 198926 and three 198414
198927	2539	" " " complete, Nos. 198838, 198922, 198923 and 198925

## Singerlight

No.	Plate	
*193254	2583	Singerlight Lamp Contact Lead Terminal for 199006 ...
*193633	2583	" " " " " " 193634 ...
*193278	2583	" " " " " " Plate ...
*193634	—	" " " " " " 193278 with 193633, for 199009
51203	2583	" " " " " " Screw (brass) ...
*193253	2583	" " " " Plunger ...
*193251	—	" " " " Bushing ...
*193252	2583	" " " " Spring ...
196361	—	" Lead for 196359 ...
196324	—	" " " 196323 ...
194525	—	" " Identification Tube (red) ...
194526	—	" " " " (yellow) ...
196328	2583	" " Slot Cover ...
196355	2583	" " Strain Relief Disc ...
195834	2583	" " Terminal Eyelet ...
50566	2583	" " " Screw (brass) for 199005 ...
51290	2583	" " " " ( " ) " 199008 ...
196359	2583	Singerlight Lead, complete, Nos. 194525, 194526, 196361 and two 195834, for Great Britain and Australia ...
196323	—	Singerlight Lead, complete, Nos. 194525, 194526, 196324 and two 195834, for Switzerland, Norway and Denmark ...
196326	2583	Singerlight Shade ...
193437	2583	" " Friction Washer ...
196330	2583	" " Insulating Bushing ...
*193267	2583	" " Position Pin ...
*199007	—	" Socket Body, with 193255 and two 193251 ...
199005	—	Singerlight Socket, complete, Nos. 196327, 196328, 196355, 196359, 199006, two each 50566 and 51385x, for Great Britain and Australia ...
199008	—	Singerlight Socket, complete, Nos. 196323, 196327, 196328, 196355, 199009, two each 51290 and 51385x, for Switzerland, Norway and Denmark ...
*199006	—	Singerlight Switch Mechanism, complete, Nos. 51399, 193254, 193256 to 193258, 194659, 199007, two each 51203, 193252, 193253 and 193267 for 199005 ...
*199009	—	Singerlight Switch Mechanism, complete, Nos. 51399, 193257, 193258, 193634, 193635, 194659, 199007, two each 51203, 193252, 193253 and 193267 for 199008 ...
*193259	2583	Singerlight Toggle Switch Contact ...
*194660	2583	Singerlight Toggle Switch Frame ...
51399	2583	" " " " Screw (brass) ...
*194599	2583	" " " Operating Lever ...
*194661	2583	" " " " Hinge Pin ...



SINGERLIGHTS

No.	Plate	
194659	2583	Singerlight Toggle Switch, complete, Nos. 193259, 193387, 193765, 194599, 194660, 194661 and 194695 ... ..
196327	2583	Singerlight Toggle Switch Shell ... ..
51385x	2583	" " " " Screw ... ..
*193258	2583	" " " " Spring Contact (left) ... ..
*193257	2583	" " " " (right) ... ..
51203	2583	" " " " ( " ) Screw ... ..
*193256	2583	" " " " Lead Terminal for 199006
*193633	2583	" " " " " " " " for 193635
*193276	2583	" " " " " " " " Plate
*193635	—	" " " " " " " " " " 193276 with 193633
*193255	—	" " " " " " " " Lead Terminal Stud
*193387	2583	" " " " Toggle Lever ... ..
*194695	2583	" " " " " " Spring ... ..
*193765	2583	" " " " " " Washer ... ..
199004	2583	Singerlight (moulded, less lamp), complete, Nos. 641zj, 193437, (Great Britain 196326, 196330 and 199005 ... .. and Australia)
199004	2583	Singerlight (moulded, less lamp), complete, Nos. 641zj, 193437, (Switzerland, Norway and Denmark) 196326, 196330 and 199008 ... ..
641zj	2583	Singerlight Screw ... ..

SINGERLIGHT LAMP

No.	Plate	
194120	2583	Singerlight Lamp ... ..

NOTE.—In ordering it is necessary to state the exact voltage required.  
Example—194120, 240 Volts.

## Bobbin Winder Parts

(The Belt Guard is an Integral Part of the Machine Arm)

No.	Plate							
45838	—	Frame	...	...	...	...	...	...
45859	2527	"	45838 with 45860 and 45862	...	...	...	...	...
51355x	2527	"	Hinge Screw	...	...	...	...	...
45775	2527	"	"	"	Friction Washer (under head of screw)	...	...	...
45812	2527	"	"	"	Washer (between frame and belt guard)	...	...	...
*45860	—	Pulley	...	...	...	...	...	...
*45861	—	Spindle	...	...	...	...	...	...
*45862	—	"	45861 with 45836 and 45837	...	...	...	...	...
*45836	—	"	Bobbin Retaining Spring	...	...	...	...	...
*45837	—	"	"	"	"	Collar	...	...
45857	2527	Tension Bracket	...	...	...	...	...	...
45858	2527	Tension Bracket, complete, Nos. 1607r, 45846, 45847, 45857, 51497zb and two 45845	...	...	...	...	...	...
1423r	2527	Tension Bracket Screw	...	...	...	...	...	...
45845	2527	"	Disc	...	...	...	...	...
51497zb	2527	"	"	Screw	...	...	...	...
1607r	2527	"	"	"	Nut	...	...	...
45846	2527	"	"	"	Washer	...	...	...
45847	2527	"	"	Spring	...	...	...	...

# Attachments

## ATTACHMENT SET

(Supplied with Machine to Great Britain)

No.	Plate						
121464	2574	Binder ...	...	...	...	...	...
36865	2574	Edge Stitcher ...	...	...	...	...	...
121441	2574	Gathering Foot (double toe)	...	...	...	...	...
35931	2574	Hemmer (adjustable)	...	...	...	...	...
15 × 1	—	Needles (6)	...	...	...	...	...
86642	2574	Ruffler	...	...	...	...	...
25537	2574	Screw Driver (machine)	...	...	...	...	...
120378	2574	" " (bobbin case)	...	...	...	...	...
8879	2574	Spool Pin Washer (cloth)	...	...	...	...	...
160810	—	Set of Attachments complete, Nos. 25537, 35931, 36865, 86642, 120378, 121441, 121464, two 8879 and six needles.	...	...	...	...	...
160811	—	Set of Attachments, (less needles), complete, Nos. 25537, 35931, 36865, 86642, 120378, 121441, 121464 and two 8879	...	...	...	...	...
120855	2575	Hemmer (foot) $\frac{5}{8}$ " hem	...	...	...	...	...
45785	2590	Rotating Hook Bobbin ( $\frac{3}{8}$ )	...	...	...	...	...
120861	—	Tin of Oil (3 oz.)	...	...	...	...	...

The following may be purchased separately :

25525	2575	Bias Gauge	...	...	...	...	...
25527b	2575	Cloth Guide	...	...	...	...	...
50053b	2575	" " and Under Braider Thumb Screw	...	...	...	...	...
120914	2575	Feller (foot)	...	...	...	...	...
35932	2575	Quilter	...	...	...	...	...
121170	909	Ruffler Shirring Plate	...	...	...	...	...
25539	2575	Stiletto	...	...	...	...	...
36583	1956	Tucker	...	...	...	...	...
121547	909	Under Braider	...	...	...	...	...

## ART WORK AND DARNING

No.	Plate						
85893	1956	Embroidery Foot (for Art Work)	...	...	...	...	...
108002	2590	Feed Cover Plate	...	...	...	...	...
121091	—	Darning Foot	...	...	...	...	...
121092	—	" " Shank	...	...	...	...	...
121093	—	" " Spring	...	...	...	...	...
121094	2575	Darning Foot (spring), complete, Nos. 121091 to 121093	...	...	...	...	...

## BRAIDER

No.	Plate		...	...	...	...	...
25510	—	Braider	...	...	...	...	...

## CORDING FEET

## For Stitching on Edge and Inserting Cord

No.	Plate		...	...	...	...	...
125035	2575	Presser Foot for sewing on left side of needle	...	...	...	...	...
121875	—	Presser Foot	...	...	...	...	...
140347w	2575	" " Adjusting Thumb Screw	...	...	...	...	...
121876	—	" " Body	...	...	...	...	...
121877	2575	Presser Foot (adjustable for sewing on the right or left side of the needle), complete, Nos. 121875, 121876 and 140347w, for Cording and Slide Fastener Work	...	...	...	...	...

## IMITATION HEMSTITCHING ATTACHMENT

No.	Plate		...	...	...	...
120687	1956	with Yielding Presser Plate	...	...	...	...

## NEEDLE THREADER (UNIVERSAL)

No.	Plate		...	...	...	...	...
121631	2590	Needle Threader Hook	...	...	...	...	...
140157j	2590	" " " Screw	...	...	...	...	...
121632	2590	Needle Threader with 140157j and three 121631	...	...	...	...	...

## EMBROIDERY HOOPS (Plain)

## (BIRCH)

No.	Plate		...	...	...	...
87586	—	Round, $5\frac{5}{8}$ " diam. $\times 7\frac{m}{m}$ high	...	...	...	...
96416	—	" 7" " $\times 7\frac{m}{m}$ "	...	...	...	...
87589	1221	" 8" " $\times 7\frac{m}{m}$ "	...	...	...	...
87593	—	" 10" " $\times \frac{7}{16}$ " "	...	...	...	...
87595	—	" 12" " $\times \frac{1}{2}$ " "	...	...	...	...
96422	1221	Oval, $9" \times 4\frac{1}{2}" \times 7\frac{m}{m}$ high	...	...	...	...
87597	—	" $12" \times 5\frac{1}{2}" \times 7\frac{m}{m}$ "	...	...	...	...

**EMBROIDERY HOOPS (with Clamp)**  
(BIRCH)

No.	Plate	
96417	—	Round, $5\frac{3}{8}$ " diam. $\times$ $7\frac{m}{m}$ " high, with SS528j, NN95j, two 96425 and four 96427
96418	—	" 7" " $\times$ $7\frac{m}{m}$ " " " SS528j, NN95j, two 96426 and four 96427
96419	—	" 8" " $\times$ $7\frac{m}{m}$ " " " SS528j, NN95j, two 96426 and four 96427
96420	—	" 10" " $\times$ $7\frac{m}{16}$ " " " SS528j, NN95j, two 96426 and four 96427
96421	—	" 12" " $\times$ $\frac{1}{2}$ " " " SS528j, NN95j, two 96844 and four 96845
96423	—	Oval, $9" \times 4\frac{1}{2}" \times 7\frac{m}{m}$ " high, with SS528j, NN95j, 96425, 96426 and four 96427
96424	—	" $12" \times 5\frac{1}{2}" \times 7\frac{m}{m}$ " " " SS528j, NN95j, 96425, 96426 and four 96427
96425	2399	Clamping Bracket for 96417, 96423 and 96424 ... ..
96426	2399	" " " 96418 to 96420, 96423 and 96424 ... ..
96844	2399	" " " 96421 ... ..
96427	2399	" " Rivet for 96417 to 96420, 96423 and 96424 ... ..
96845	2399	" " " 96421 ... ..
SS528j	2399	" " Screw ... ..
NN95j	2399	" " Nut ... ..

**Portable Carrying Case**  
No. 45832

No.	Plate	
136148	2541	Cover Hinge with four 136149 ... ..
136149	2541	" " Rivet $\frac{9}{16}$ ", for 136148 ... ..
136150	2541	" Lock (left) with four 136145 ... ..
136189	2541	" " (right) with four 136145 ... ..
136151	2541	" " Hasp with two 136145 ... ..
136145	2541	" " " Rivet $\frac{9}{16}$ ", for 136151 ... ..
136152	2541	" " Key ... ..
136145	2541	" " Rivet $\frac{9}{16}$ ", for 136150 and 136189 ... ..
124416	2541	Dome (bottom) ... ..
136359	—	Handle, for 136361 ... ..
136360	—	" Post, complete, for 136361 ... ..
136361	2541	Handle, complete, Nos. 136359 and two 136360 ... ..
96947	—	Oiler Holder (wire) with two wood screws $\frac{3}{8}$ " No. 8 R.H. ... ..
100401	2541	Tray with 136082 and 136084 ... ..
136082	2541	" Hole Cover with two 136067 and three 136066, for 100401
136084	2541	" " " " two each 136066 and 136067, for 100401
136067	2541	" " " Rivet $\frac{1}{4}$ ", for 136082 and 136084 ... ..
136066	2541	" " " " $\frac{3}{16}$ ", for 136082 and 136084 ... ..

## Numerical List of Parts

No.	Plate	
NN95j	2399	Embroidery Hoop Clamping Bracket Screw Nut, for 96417 to 96421, 96423 and 96424
145r	2587	Three-Pin Terminal Body (male half) Screw
171al	2525	Feed Lifting Connecting Rod Cap Screw for 45725 ... ..
208al	2528	Feed Dog Screw ... ..
233zj	2528	Rotating Hook Bobbin Case Position Plate Screw ... ..
248za	2525	Clamp Stop Motion Clamp Stop Screw ...
315c	2528	Feed Bar Screw Centre for 15445 ...
330r	2527	Arm Top Cover Screw ... ..
335zb	2527	Slack Thread Regulator and Tension Thread Guide Screw ... ..
447c	2525	Rotating Hook Collar and Counterbalance Set Screw for 45833 ... ..
448c	2525	Feed Lifting Rock Shaft Centre (left) Set Screw ... ..
448c	2525	Feed Lifting Rock Shaft Centre (right) Set Screw ... ..
448c	2525	Feed Rock Shaft Centre (left) Set Screw ...
448c	2525	Feed Rock Shaft Centre (right) Set Screw ...
448c	2525	Rotating Hook Shaft Bushing (back) Set Screw for 108003 ... ..
448c	2525	Rotating Hook Shaft Bushing (front) Set Screw for 108003 ... ..
453c	2529	Presser Bar Guide Bracket Set Screw for 45742 ... ..
457c	2527	Tension Stud Set Screw ... ..
462c	2525	Needle Bar Bushing (upper) Set Screw ...
462al	2525	Rotating Hook Set Screw for 45827 ...
SS528j	2399	Embroidery Hoop Clamping Bracket Screw for 96417 to 96421, 96423 and 96424 ...
SS541	2587	Two-Pin Plug Contact Pin Screw for 198052
SS542	2587	Two-Pin Plug Body Fastening Screw for 198052 ... ..
641zj	2583	Singerlight Screw for 199004 ... ..
691za	2528	Throat Plate Screw ... ..
704r	2587	Three-Pin Terminal Box Cover Screw (large)
914r	2587	Bed Lead Guard Fastening Screw ...
999c	2528	Feed Bar Connecting Link Hinge Screw ...
1036al	2590	Thread Take-up Crank Set Screw for 45740 ...
1085e	2525	Feed Forked Connection Roller Screw Stud for 1832 ... ..
1134al	2525	Needle Bar Crank Position Screw for 45740 ...

No.	Plate	
1259c	2525	Arm Shaft (horizontal) Bevel Gear Set Screw for 45881 ... ..
1259c	2525	Arm Shaft (upright) Bevel Gear (lower) Set Screw for 45852 ... ..
1259c	2525	Arm Shaft (upright) Bevel Gear (upper) Set Screw for 45853 ... ..
1259c	2525	Rotating Hook Shaft Bevel Gear Set Screw for 45854 ... ..
1423r	2527	Bobbin Winder Tension Bracket Screw ...
1519r	2528	Feed Bar Screw Centre Nut for 15445 ...
1520j	2525	Feed Lifting Connecting Rod Hinge Screw Nut ... ..
1520j	2525	Feed Forked Connection Hinge Screw Nut ...
1607j	2527	Controller Resistance Unit Bell Crank Hinge Screw Nut for 194418 ... ..
1607j	2527	Controller Resistance Unit Yoke Hinge Screw Nut for 194418 ... ..
1607r	2527	Bobbin Winder Tension Disc Screw Nut for 45858 ... ..
1735e	2525	Feed Reversing Handle Lock Nut ...
1768x	2582	Three-Pin Terminal (female half) Housing Screw Nut for 198963 and 198999 ...
1832	2525	Feed Forked Connection Roller with 1085e, for 45754 ... ..
2102	2527	Tension Disc for 45871 ... ..
8217	2525	Feed Regulator Hinge Screw Friction Washer
8422	2527	Thread Guard (head of arm, upper) ...
8879	2574	Arm Top Cover Spool Pin Washer (cloth) ...
8879	2526	Bed Cover Plate (bottom) Screw Thumb Nut Washer (cloth) ... ..
8905	2535	Motor Screw Washer ... ..
9046	2525	Arm Dowel Pin ... ..
15445	—	Feed Bar Screw Centre 315c with 1519r ...
23258	2538	Controller Resistance Unit Screw Washer (steel) for 194569 to 194571 ... ..
25510	—	Braider ... ..
25525	2575	Bias Gauge ... ..
25527b	2575	Cloth Guide ... ..
25537	2574	Screw Driver (machine) for 160810 and 160811 ... ..
25539	2575	Stiletto ... ..
26075	2529	Thread Cutter and Holder ... ..
32519	2529	Needle Stop Pin for 45734 ... ..
33624	2529	Pressure Regulating Thumb Screw Extension Pin for 45813 ... ..
33660	2529	Tension Releasing Lever Spring ... ..

NUMERICAL LIST OF PARTS

55

No.	Plate	
35931	2574	Hemmer (adjustable) for 160810 and 160811
35932	2575	Quilter ... ..
36583	1956	Tucker ... ..
36865	2574	Edge Stitcher for 160810 and 160811 ...
45319	—	Presser Foot Plate for 45321 ... ..
45320	—	Presser Foot Shank for 45321 ... ..
45321	2529	Presser Foot (hinged), complete, Nos. 45319, 45320 and 45329 ... ..
45329	2529	Presser Foot Hinge Pin for 45321 ... ..
45339	2527	Tension Regulating Thumb Nut Engaging Pin for 51681zb ... ..
*45701	—	Arm for 45814 ... ..
45704	2525	Arm Shaft (horizontal) Bushing for 45814 ...
45705	2525	Arm Shaft (upright) ... ..
45706	2525	Arm Shaft (upright) Bushing (lower) for 45814 ... ..
45707	2525	Arm Shaft (upright) Bushing (upper) for 45814 ... ..
45708	2527	Arm Top Cover for 45795 ... ..
45709	2527	Arm Top Cover Spool Pin for 45795 ... ..
45712	—	Bed Cover Plate (bottom) for 45800 ... ..
45713	2526	Bed Extension ... ..
45714	2526	Bed Extension Hinge Screw Friction Washer
45716	2525	Clamp Stop Motion Clamp Washer ... ..
45717	2525	Clamp Stop Motion Flanged Bushing for 45765 ... ..
*45718	—	Face Plate for 45719 ... ..
45719	2527	Face Plate 45718 with 45842 and 139615 ...
45721	2528	Feed Bar ... ..
45722	2528	Feed Bar Connecting Link ... ..
45723	2528	Feed Bar Connecting Link Hinge Stud ... ..
45724	2525	Feed Cam and Feed Lifting Eccentric with 50275c ... ..
45725	2525	Feed Lifting Connecting Rod with 45726 and two 171al ... ..
*45726	—	Feed Lifting Connecting Rod Cap for 45725
45727	2525	Feed Forked Connection for 45754 ... ..
45728	2528	Feed Lifting Rock Shaft... ..
45729	2528	Feed Lifting Rock Shaft Centre (left) ... ..
45729	2528	Feed Rock Shaft Centre (left) ... ..
45730	2528	Feed Lifting Rock Shaft Centre (right) ... ..
45730	2528	Feed Rock Shaft Centre (right) ... ..
45731	2525	Feed Regulator ... ..
45732	2525	Feed Reversing Handle for 45794... ..
45733	2528	Feed Rock Shaft ... ..
45734	2529	Needle Bar (hollow) with 32519 ... ..
45736	2529	Needle Bar Bushing (upper) ... ..



No.	Plate	
45739	2529	Needle Bar Connecting Stud with 51363e, for 45819 ... ..
45740	2525	Needle Bar Crank with 1036al and 1134al for 45886 ... ..
45741	2529	Presser Bar ... ..
45742	2529	Presser Bar Guide Bracket with 453c ...
45744	2529	Presser Bar Lifter Hinge Pin ... ..
45745	2529	Presser Bar Spring for 45813 ... ..
*45750	—	Rotating Hook Bobbin Case for 45751 ...
45751	2525	Rotating Hook Bobbin Case, complete, Nos. 45750, 45789, 200592c, 200964e, 201016f, 206736 and 210736, for 45830 ... ..
45752	2525	Rotating Hook Bobbin Case Base for 45829
45754	—	Feed Forked Connection 45727 with 1832 ...
45759	2525	Rotating Hook Shaft Bushing (back) for 108003 ... ..
45760	2525	Rotating Hook Shaft Bushing (front) for 108003 ... ..
45761	2525	Rotating Hook Loop Guard for 45829 ...
45763	2525	Stitch Indicator Plate ... ..
45765	—	Clamp Stop Motion Flanged Bushing 45717 with 51350zb ... ..
45771	2529	Thread Take-up Lever Link Hinge Screw Washer for 45823 ... ..
45772	2528	Throat Plate for 45788 ... ..
45775	2527	Bobbin Winder Frame Hinge Screw Friction Washer (under head of screw) ...
45780	2526	Bed Cushion (rubber) ... ..
45782	2527	Thread Guard (head of arm, lower) ...
45785	2590	Rotating Hook Bobbin ... ..
45788	2528	Feed Dog, 12 teeth (14 teeth to the inch) for 45772 ... ..
45789	2525	Rotating Hook Bobbin Case Tension Spring for 45751 ... ..
45794	—	Feed Reversing Handle 45732 with 51622zb
45795	2527	Arm Top Cover 45708 with 45709 ... ..
45798	2526	Bed Extension Hinge Screw Washer ...
*45799	—	Bed Cover Plate (bottom) Felt for 45800 ...
45800	2526	Bed Cover Plate (bottom) 45712 with 45799
45807	2528	Rotating Hook Bobbin Case Position Plate Spring (back) for 45850 ... ..
45808	2528	Rotating Hook Bobbin Case Position Plate Spring (front) for 45850 ... ..
45812	2527	Bobbin Winder Frame Hinge Screw Washer (between frame and belt guard) ...
45813	—	Presser Bar Spring 45745 with 33624 ...

No.	Plate	
*45814	—	Arm 45701 with 45706, 45707 and two 45704 ... ..

*NOTE.—Due to the accuracy required for gear alignment, Arm cannot be supplied separately and can only be sent as a unit, Arm and Bed assembled.*

45817	2525	Balance Wheel ... ..
45818	2529	Needle Bar Connecting Link for 45819 ...
45819	—	Needle Bar Connecting Link 45818 with 45739, for 45823 ... ..
45820	2529	Thread Take-up Crank for 45823 ... ..
*45821	2529	Thread Take-up Lever for 45822 ... ..
45822	—	Thread Take-up Lever, complete, Nos. 45821, 45824 and 45825, for 45823 ... ..
45823	—	Thread Take-up Lever 45822 with 45771, 45819, 45820, 50057c and 140465e ...
*45824	2529	Thread Take-up Lever Hinge Stud for 45822
*45825	2529	Thread Take-up Lever Link for 45822 ...
45826	2527	Spool Holder Spring ... ..
45827	2525	Rotating Hook with two 462al, for 45828 and 45829 ... ..
45828	—	Rotating Hook 45827 with 45831, 200596f and 200614c (for Agents only) ...
45829	—	Rotating Hook 45827 with 45752, 45761, 45831, 200145c, 200596f and 200614c, for 45830 ... ..
45830	2525	Rotating Hook and Bobbin Case, complete, Nos. 45751 and 45829 ... ..
45831	2525	Rotating Hook Gib for 45828 and 45829 ...
45832	2541	Portable Carrying Case, complete ...
45833	2525	Rotating Hook Collar and Counterbalance with 447c ... ..
45834	2525	Rotating Hook Shaft ... ..
*45836	—	Bobbin Winder Spindle Bobbin Retaining Spring for 45862 ... ..
*45837	—	Bobbin Winder Spindle Bobbin Retaining Spring Collar for 45862 ... ..
45838	—	Bobbin Winder Frame for 45859 ... ..
45842	2527	Face Plate Thread Guard (lower) 45875 with 125424, for 45719 ... ..
45845	2527	Bobbin Winder Tension Disc for 45858 ...
45846	2527	Bobbin Winder Tension Disc Screw Washer for 45858 ... ..
45847	2527	Bobbin Winder Tension Disc Spring for 45858
45849	2528	Rotating Hook Bobbin Case Position Plate for 45850 ... ..
45850	—	Rotating Hook Bobbin Case Position Plate 45849 with 45807, 45808 and two 51159j

No.	Plate	
45852	2525	Arm Shaft (upright) Bevel Gear (lower) with two 1259c for 45901 ... ..
45853	2525	Arm Shaft (upright) Bevel Gear (upper) with two 1259c for 45900 ... ..
45854	2525	Rotating Hook Shaft Bevel Gear with two 1259c for 45901 ... ..
45857	2527	Bobbin Winder Tension Bracket for 45858 ...
45858	2527	Bobbin Winder Tension Bracket, complete, Nos. 1607r, 45846, 45847, 45857, 51497zb and two 45845 ... ..
45859	2527	Bobbin Winder Frame 45838 with 45860 and 45862 ... ..
*45860	—	Bobbin Winder Pulley for 45859 ... ..
*45861	—	Bobbin Winder Spindle for 45862 ... ..
*45862	—	Bobbin Winder Spindle 45861 with 45836 and 45837 for 45859 ... ..
45863	2527	Slack Thread Regulator and Tension Thread Guide ... ..
45864	2527	Tension Indicator Flange for 45871 ...
45865	2527	Tension Indicator Flange Stop Washer for 45871 ... ..
45866	2527	Tension Indicator for 45871 ... ..
45868	2527	Tension Releasing Pin for 45871 ... ..
45869	2527	Tension Spring for 45871 ... ..
45870	—	Tension Stud 140167zb with 51681zb, for 45871 ... ..
45871	2527	Tension (graduated) complete, Nos. 45864 to 45866, 45868 to 45870, 45873, 66774 and two 2102 ... ..
45873	2527	Thread Take-up Spring Thread Guard for 45871 ... ..
45874	2527	Face Plate Thread Guard (upper) for 139615
45875	2590	Face Plate Thread Guard (lower) for 45842
45877	2590	Needle Clamp Body with 140545zc, for 45878
45878	2529	Needle Clamp Body 45877 with 51308zj ...
45879	2529	Needle Clamp Gib and Thread Guard ...
45880	2525	Arm Shaft (horizontal) for 45886 ... ..
45881	2525	Arm Shaft (horizontal) Bevel Gear with 1259c and 140333c for 45900 ... ..
45886	—	Arm Shaft (horizontal) 45880 with 45740 ...
45900	—	Set of Mated Gears (upper shaft), complete, Nos. 45853 and 45881 ... ..
45901	—	Set of Mated Gears (lower shaft), complete, Nos. 45852 and 45854 ... ..
45909	2529	Tension Releasing Lever ... ..
45910	2529	Presser Bar Lifter ... ..
50053b	2575	Cloth Guide and Under Braider Thumb Screw

NUMERICAL LIST OF PARTS

59

No.	Plate	
50054zb	2529	Pressure Regulating Thumb Screw ...
50057c	2529	Thread Take-up Lever Link Hinge Screw for 45823 ... ..
50116e	2526	Bed Cushion Screw ... ..
50275c	2525	Feed Cam and Feed Lifting Eccentric Set Screw for 45724 ... ..
50353e	2525	Feed Regulator Hinge Screw ... ..
50566	2583	Singerlight Lead Terminal Screw (brass) for 199005 ... ..
50684zb	2527	Face Plate Thumb Screw ... ..
51093x	2582	Three-Pin Terminal (female half) Housing Screw for 198963 and 198999 ... ..
51159j	2528	Rotating Hook Bobbin Case Position Plate Spring Screw for 45850 ... ..
51203	2583 <sup>1</sup>	Singerlight Lamp Contact Lead Terminal Screw (brass) for 199006 and 199009 ... ..
51203	2583	Singerlight Toggle Switch Spring Contact (right) Screw for 199006 and 199009 ... ..
51207r	2535	Motor Pulley Set Screw ... ..
51208r	2535	Motor Screw ... ..
51290	2583	Singerlight Lead Terminal Screw (brass) for 199008 ... ..
51308zj	2529	Needle Clamp Position Screw for 45878 ... ..
51327j	2582	Controller Resistance Unit Short Circuiting Contact Screw ... ..
51340c	2582	Controller Resistance Unit Bell Crank Hinge Screw for 194418 ... ..
51340c	2582	Controller Resistance Unit Yoke Hinge Screw for 194418 ... ..
51350zb	2525	Clamp Stop Motion Clamp Screw for 45765
51351c	2525	Clamp Stop Motion Flanged Bushing Screw
51352c	2525	Feed Lifting Connecting Rod Hinge Screw (eccentric)
51353c	2525	Feed Forked Connection Hinge Screw (eccentric)
51354c	2529	Tension Releasing Lever Hinge Screw ... ..
51355x	2527	Bobbin Winder Frame Hinge Screw ... ..
51361r	2526	Bed Cover Plate (bottom) Screw ... ..
51363e	2529	Needle Bar Connecting Stud Clamping Screw for 45739 ... ..
51369r	2587	Three-Pin Terminal Box Cover Screw (small)
51380r	2526	Bed Extension Hinge Screw ... ..
51384zb	2525	Stitch Indicator Plate Screw ... ..
51385x	2583	Singerlight Toggle Switch Shell Screw for 199005 and 199008 ... ..
51399	2583	Singerlight Toggle Switch Frame Screw (brass) for 199006 and 199009 ... ..

No.	Plate	
51472e	2525	Arm Screw ... ..
51497zb	2527	Bobbin Winder Tension Disc Screw for 45858
51621r	2526	Bed Cover Plate (bottom) Screw Thumb Nut
51622zb	2525	Stitch Regulating Thumb Nut for 45794 ...
51681zb	2527	Tension Regulating Thumb Nut with 45339, for 45870 ... ..
66774	2527	Thread Take-up Spring for 45871 ...
85893	1956	Embroidery Foot (for Art Work) ...
86642	2574	Ruffler for 160810 and 160811 ...
87586	—	Embroidery Hoop (round, birch), $5\frac{3}{8}$ " diam. $\times$ $7\frac{m}{m}$ high ... ..
87589	1221	Embroidery Hoop (round, birch), 8" diam. $\times$ $7\frac{m}{m}$ high ... ..
87593	—	Embroidery Hoop (round, birch), 10" diam. $\times \frac{7}{16}$ " high ... ..
87595	—	Embroidery Hoop (round, birch), 12" diam. $\times \frac{1}{2}$ " high ... ..
87597	—	Embroidery Hoop (oval, birch), $12" \times 5\frac{1}{2}" \times$ $7\frac{m}{m}$ high ... ..
96416	—	Embroidery Hoop (round, birch), 7" diam. $\times 7\frac{m}{m}$ high ... ..
96417	—	Embroidery Hoop (round, birch), $5\frac{3}{8}$ " diam. $\times 7\frac{m}{m}$ high with SS528j, NN95j, two 96425 and four 96427 ... ..
96418	—	Embroidery Hoop (round, birch), 7" diam. $\times 7\frac{m}{m}$ high with SS528j, NN95j, two 96426 and four 96427 ... ..
96419	—	Embroidery Hoop (round, birch), 8" diam. $\times$ $7\frac{m}{m}$ high with SS528j, NN95j, two 96426 and four 96427 ... ..
96420	—	Embroidery Hoop, (round, birch), 10" diam. $\times \frac{7}{16}$ " high with SS528j, NN95j, two 96426 and four 96427 ... ..
96421	—	Embroidery Hoop (round, birch), 12" diam. $\times \frac{1}{2}$ " high with SS528j, NN95j, two 96844 and four 96845 ... ..
96422	1221	Embroidery Hoop (oval, birch) $9" \times 4\frac{1}{2}" \times 7\frac{m}{m}$ high ... ..
96423	—	Embroidery Hoop (oval, birch), $9" \times 4\frac{1}{2}" \times$ $7\frac{m}{m}$ high with SS528j, NN95j, 96425, 96426 and four 96427 ... ..
96424	—	Embroidery Hoop (oval, birch), $12" \times 5\frac{1}{2}" \times$ $7\frac{m}{m}$ high with SS528j, NN95j, 96425, 96426 and four 96427 ... ..
96425	2399	Embroidery Hoop Clamping Bracket for 96417, 96423 and 96424 ... ..

NUMERICAL LIST OF PARTS

61

No.	Plate	
96426	2399	Embroidery Hoop Clamping Bracket for 96418 to 96420, 96423 and 96424 ...
96427	2399	Embroidery Hoop Clamping Bracket Rivet for 96417 to 96420, 96423 and 96424 ...
96844	2399	Embroidery Hoop Clamping Bracket for 96421 ...
96845	2399	Embroidery Hoop Clamping Bracket Rivet for 96421 ...
96947	—	Carrying Case Oiler Holder (wire) with two wood screws $\frac{3}{8}$ " No. 8 R.H., for 45832 ...
97382	2587	Bayonet Plug, complete, Nos. 97383 and 97384 for Great Britain and Australia ...
97383	2587	Bayonet Plug Body for 97382 ...
97384	2587	Bayonet Plug Cover for 97382 ...
100401	2541	Carrying Case Tray with 136082 and 136084, for 45832 ...
*108001	—	Bed ...
108002	2590	Feed Cover Plate ...
*108003	—	Bed 108001 with 45759, 45760 and two 448c
<p><i>NOTE.—Due to the accuracy required for gear alignment, Bed cannot be supplied separately and can only be sent as a unit, Arm and Bed assembled.</i></p>		
120378	2574	Screw Driver (bobbin case) for 160810 and 160811 ...
120687	1956	Imitation Hemstitching Attachment with Yielding Presser Plate ...
120855	2575	Hemmer (foot) for $\frac{5}{8}$ " hem ...
120861	—	Tin of Oil (3 oz.) ...
120914	2575	Feller (foot) ...
121091	—	Darning Foot for 121094 ...
121092	—	Darning Foot Shank for 121094 ...
121093	—	Darning Foot Spring for 121094 ...
121094	2575	Darning Foot (spring), complete, Nos. 121091 to 121093 ...
121170	909	Ruffler Shirring Plate ...
121441	2574	Gathering Foot (double toe) for 160810 and 160811 ...
121464	2574	Binder for 160810 and 160811 ...
121547	909	Under Braider ...
121631	2590	Needle Threader Hook for 121632 ...
121632	2590	Needle Threader (universal), with 140157j and three 121631 ...
121875	—	Presser Foot for 121877 ...
121876	—	Presser Foot Body for 121877 ...

No.	Plate	
121877	2575	Presser Foot (adjustable for sewing on the right or left side of the needle), complete, Nos. 121875, 121876 and 140347w, for Cording and Slide Fastener Work ...
124416	2541	Carrying Case Dome (bottom) for 45832 ...
125035	2575	Presser Foot for stitching on edge and inserting cord, (for sewing on left side of needle)
125424	2527	Face Plate Thread Guard (lower) Rivet for 45842 ... ..
125424	2527	Face Plate Thread Guard (upper) Rivet for 139615 ... ..
136066	2541	Carrying Case Tray Hole Cover Rivet $\frac{3}{16}$ ", for 136082 and 136084 ... ..
136067	2541	Carrying Case Tray Hole Cover Rivet $\frac{1}{4}$ ", for 136082 and 136084 ... ..
136082	2541	Carrying Case Tray Hole Cover with two 136067 and three 136066 for 100401 ...
136084	2541	Carrying Case Tray Hole Cover with two each 136066 and 136067, for 100401 ...
136145	2541	Carrying Case Cover Lock Hasp Rivet $\frac{9}{16}$ " for 136151 ... ..
136145	2541	Carrying Case Cover Lock Rivet $\frac{9}{16}$ " for 136150 and 136189 ... ..
136148	2541	Carrying Case Cover Hinge with four 136149, for 45832 ... ..
136149	2541	Carrying Case Cover Hinge Rivet $\frac{9}{16}$ " for 136148 ... ..
136150	2541	Carrying Case Cover Lock (left) with four 136145, for 45832 ... ..
136151	2541	Carrying Case Cover Lock Hasp with two 136145, for 45832 ... ..
136152	2541	Carrying Case Cover Lock Key, for 45832...
136189	2541	Carrying Case Cover Lock (right) with four 136145, for 45832 ... ..
136359	—	Carrying Case Handle for 136361 ... ..
136360	—	Carrying Case Handle Post, complete, for 136361 ... ..
136361	2541	Carrying Case Handle, complete, Nos. 136359 and two 136360, for 45832 ... ..
139615	—	Face Plate Thread Guard (upper) 45874 with 125424 for 45719 ... ..
140099x	2582	Controller Base Screw for 198995 to 198996
140100x	2538	Controller Resistance Unit Bell Crank Spring Bracket Screw for 194569 to 194571 ...
140103x	2582	Controller Resistance Unit Screw for 194569 to 194571 ... ..

NUMERICAL LIST OF PARTS

63

No.	Plate	
140125	2587	Three-Pin Terminal (female half) Housing (lower) Lead Screw for 198968 and 199001
140157j	2590	Needle Threader Hook Screw for 121632 ...
140167zb	2527	Tension Stud for 45870 ... ..
140240zb	2529	Presser Foot Thumb Screw ... ..
140333c	2538	Arm Shaft (horizontal) Bevel Gear Position Screw, for 45881 ... ..
140347w	2575	Presser Foot Adjusting Thumb Screw for 121877 ... ..
140445	2535	End Cover Fastening Screw (upper) ...
140465e	2529	Thread Take-up Lever Cap Screw for 45823
140545zc	2590	Needle Clamp Thumb Screw for 45877 ...
160810	—	Set of Attachments, complete, Nos. 25537, 35931, 36865, 86642, 120378, 121441, 121464, two 8879 and six needles ...
160811	—	Set of Attachments (less needles), complete, Nos. 25537, 35931, 36865, 86642, 120378, 121441, 121464 and two 8879 ... ..
190328	2589	Three-Pin Terminal Box Cover Bushing (rubber) for Singerlight and Suppressor Leads ... ..
190439	2590	Tube, filled with Singer Lubricant for Electric Motors for 190613 ... ..
190612	—	Tube Carton (paper) for 190613 ... ..
190613	—	Tube 190439 with 190612 ... ..
191097	2535	Armature Shaft Thrust Washer (phenolic) ...
191098	2535	Armature Shaft Thrust Washer (phenolic) ...
192140	2582	Controller Resistance Unit for 95 to 145 volts, for 194570 ... ..
192141	—	Controller Resistance Unit for 150 to 250 volts, for 194571 ... ..
192211	—	Controller Resistance Unit, for 32 to 55 volts, for 194569 ... ..
192457	2535	Brush (carbon, $\frac{7}{32}$ " square) ... ..
192458	2535	Brush Spring ... ..
*193251	—	Singerlight Lamp Contact Plunger Bushing for 199007 ... ..
*193252	2583	Singerlight Lamp Contact Plunger Spring for 199006 and 199009 ... ..
*193253	2583	Singerlight Lamp Contact Plunger for 199006 and 199009 ... ..
*193254	2583	Singerlight Lamp Contact Lead Terminal for 199006 ... ..
*193255	—	Singerlight Toggle Switch Spring Contact Lead Terminal Stud for 199007 ...
*193256	2583	Singerlight Toggle Switch Spring Contact Lead Terminal for 199006 ... ..



No.	Plate	
*193257	2583	Singerlight Toggle Switch Spring Contact (right) for 199006 and 199009 ... ..
*193258	2583	Singerlight Toggle Switch Spring Contact (left) for 199006 and 199009 ... ..
*193259	2583	Singerlight Toggle Switch Contact for 194659
*193267	2583	Singerlight Shade Position Pin for 199006 and 199009 ... ..
*193276	2583	Singerlight Toggle Switch Spring Contact Lead Terminal Plate for 193635 ... ..
*193278	2583	Singerlight Lamp Contact Lead Terminal Plate for 193634 ... ..
193384	2582	Controller Resistance Unit Short Circuiting Contact ... ..
*193387	2583	Singerlight Toggle Switch Toggle Lever for 194659 ... ..
193403	—	Two-Pin Plug Body (upper half) for 198052
193404	—	Two-Pin Plug Body (lower half) with insert for 198052 ... ..
193437	2583	Singerlight Shade Friction Washer for 199004
193536	2535	Commutator, complete ... ..
*193633	2583	Singerlight Lamp Contact Lead Terminal for 193634 ... ..
*193633	2583	Singerlight Toggle Switch Spring Contact Lead Terminal for 193635 ... ..
*193634	—	Singerlight Lamp Contact Lead Terminal Plate 193278, with 193633, for 199009 ... ..
*193635	—	Singerlight Toggle Switch Spring Contact Lead Terminal Plate 193276, with 193633, for 199009 ... ..
*193765	2583	Singerlight Toggle Switch Toggle Lever Spring Washer for 194659 ... ..
193879	2535	Field Core, complete ... ..
193907	2538	Commutator Oil Sling ... ..
194113	2535	Brush Holder Tube ... ..
194120	2583	Singerlight Lamp ... ..

NOTE.—In ordering it is necessary to state the exact voltage required.

194144	2535	Belt (moulded) ... ..
194321	2582	Controller Foot Pedal for 198995 to 198997
194326	2535	Oil Lubricating Spring ... ..
194402	2582	Controller Resistance Unit Bell Crank Spring Bracket, for 194418 ... ..
194403	2538	Controller Resistance Unit Bell Crank, for 194416 ... ..
194404	2582	Controller Resistance Unit Bell Crank Spring for 194569 to 194571 ... ..

NUMERICAL LIST OF PARTS

65

No.	Plate	
194405	2538	Controller Resistance Unit Bell Crank Spring Position Pin for 194416 ... ..
194407	2582	Controller Base Cushion (rubber), for 198995 to 198997 ... ..
194416	2582	Controller Resistance Unit Bell Crank, complete, Nos. 194405 and two 194403, for 194418 ... ..
194418	—	Controller Resistance Unit Bell Crank Spring Bracket 194402 with 194416, 194773, two each 1607j and 51340c, for 194569 to 194571 ... ..
194419	—	Controller Resistance Unit Insert Nut (brass) for 194572 ... ..
194490	2535	Oil Lubricating Wick ... ..
194494	2535	Oil Lubricating Tube ... ..
194514	2538	Controller Resistance Unit Bell Crank Spring Bracket Screw Insulating Disc for 194569 to 194571 ... ..
194525	—	Singerlight Lead Identification Tube (red) for 196323 and 196359 ... ..
194526	—	Singerlight Lead Identification Tube (yellow) for 196323 and 196359 ... ..
194569	—	Controller Base 194572 with 192211, 194418, 194774, 194775, two each 23258, 140100x, 140103x, 194404, 194514 and 931090, for 198995 ... ..
194570	—	Controller Base 194572 with 192140, 194418, 194774, 194775, two each 23258, 140100x, 140103x, 194404, 194514 and 931090, for 198996 ... ..
194571	—	Controller Base 194572 with 192141, 194418, 194774, 194775, two each 23258, 140100x, 140103x, 194404, 194514 and 931090, for 198997 ... ..
194572	2582	Controller Base with two 194419, for 194569 to 194571 ... ..
194573	2582	Controller Cover for 198995 to 198997 ... ..
194577	2538	Controller Lead Cord Insulating Sleeve $2\frac{11}{16}$ " long, for 195093 and 199016 ... ..
*194599	2583	Singerlight Toggle Switch Operating Lever for 194659 ... ..
*194604	—	Controller Lead Insulating Sleeve $3\frac{3}{16}$ " long, for 195093 and 199016 ... ..
194659	2583	Singerlight Toggle Switch, complete, Nos. 193259, 193387, 193765, 194599, 194660, 194661 and 194695, for 199006 and 199009
*194660	2583	Singerlight Toggle Switch Frame for 194659

No.	Plate	
*194661	2583	Singerlight Toggle Switch Operating Lever Hinge Pin for 194659 ... ..
*194695	2583	Singerlight Toggle Switch Toggle Lever Spring for 194659 ... ..
194717	2535	Field Coil Lead Strain Relief ... ..
194773	2582	Controller Resistance Unit Yoke for 194418
194774	2582	Controller Resistance Unit Adjusting Nut for 194569 to 194571 ... ..
194775	2582	Controller Resistance Unit Adjusting Nut Lock Spring for 194569 to 194571 ... ..
195048	—	Three-Pin Terminal Body (male half) 195049 with three 195050 for 199010 ... ..
*195049	—	Three-Pin Terminal Body (male half) for 195048 ... ..
*195050	—	Three-Pin Terminal Body (male half) Contact Prong 195051 with 195052 for 195048
*195051	—	Three-Pin Terminal Body (male half) Contact Prong for 195050 ... ..
*195052	—	Three-Pin Terminal Body (male half) Contact Prong Screw Post for 195050 ... ..
*195057	—	Three-Pin Terminal (female half) Housing (lower) Contact Prong for 198968 and 199001 ... ..
*195058	—	Three-Pin Terminal (female half) Housing (lower) Insert for 198970 and 199002 ... ..
195059	2582	Three-Pin Terminal (female half) Housing Snap Ring for 198963 and 198999 ... ..
195092	2582	Controller Lead Cord, complete, from supply socket to three-pin terminal and controller Nos. 195093, 195096, 198963 and Plug, for 198995 to 198997 for Great Britain and Australia ... ..
195093	—	Controller Lead Cord 3' 10", complete, Nos. 194577, 194604, 195094, and two 195834 for 195092 ... ..
*195094	—	Controller Lead Cord (short) 3' 10", for 195093 ... ..
195096	—	Controller Lead Cord (long) 8', for 195092 ... ..
195435	2535	Brush Cap ... ..
195436	2535	Motor Pulley ... ..
195437	—	Armature, complete, for C.A.K. 6-7 Motor ... ..
195438	2535	Armature, complete, C.A.K. 6-11 Motor ... ..
195439	—	Field Core with Coils No. 195440, complete, for C.A.K. 6-7 Motor ... ..
195440	—	Field Coils assembled for 195439 ... ..
195441	2535	Field Core with Coils No. 195442, complete, for C.A.K. 6-11 Motor ... ..

NUMERICAL LIST OF PARTS

67

No.	Plate	
195442	—	Field Coils assembled for 195441 ... ..
195464	—	Field Core with Coils No. 195465, complete, for C.A.K. 6-3 Motor ... ..
195465	—	Field Coils assembled for 195464 ... ..
195467	—	Field Core with Coils No. 195468, complete, for C.A.K. 6-5 Motor ... ..
195468	—	Field Coils assembled for 195467 ... ..
195469	—	Field Core with Coils No. 195470, complete, for C.A.K. 6-6 Motor ... ..
195470	—	Field Coils assembled for 195469 ... ..
195473	—	Field Core with Coils No. 195474, complete, for C.A.K. 6-8 Motor ... ..
195474	—	Field Coils assembled for 195473 ... ..
195475	—	Field Core with Coils No. 195476, complete, for C.A.K. 6-15 Motor ... ..
195476	—	Field Coils assembled for 195475 ... ..
195477	—	Field Core with Coils No. 195478, complete, for C.A.K. 6-9 Motor ... ..
195478	—	Field Coils assembled for 195477 ... ..
195481	—	Field Core with Coils No. 195482, complete, for C.A.K. 6-12 Motor ... ..
195482	—	Field Coils assembled for 195481 ... ..
195483	—	Field Core with Coils No. 195484, complete, for C.A.K. 6-10 Motor ... ..
195484	—	Field Coils assembled for 195483 ... ..
195487	—	Armature, complete, for C.A.K. 6-3 Motor ...
195488	—	Armature, complete, for C.A.K. 6-5 Motor ...
195489	—	Armature, complete, for C.A.K. 6-6 Motor ...
195491	—	Armature, complete, for C.A.K. 6-8 Motor ...
195492	—	Armature, complete, for C.A.K. 6-15 Motor
195493	—	Armature, complete, for C.A.K. 6-9 Motor ...
195496	—	Armature, complete, for C.A.K. 6-10 Motor
195518	—	Armature, complete, for C.A.K. 6-14 Motor
195519	—	Field Core with Coils No. 195520, complete, for C.A.K. 6-14 Motor ... ..
195520	—	Field Coils assembled, for 195519 ... ..
195725	—	Armature, complete, for C.A.K. 6-3 S.I. Motor ...
195726	—	Armature, complete, for C.A.K. 6-5 S.I. Motor
195727	—	Armature, complete, for C.A.K. 6-6 S.I. Motor
195728	—	Armature, complete, for C.A.K. 6-7 S.I. Motor
195729	—	Armature, complete, for C.A.K. 6-8 S.I. Motor
195730	—	Armature, complete, for C.A.K. 6-9 S.I. Motor
195731	—	Armature, complete, for C.A.K. 6-10 S.I. Motor ... ..
195732	—	Armature, complete, for C.A.K. 6-11 S.I. Motor ... ..

No.	Plate	
195733	—	Armature, complete, for C.A.K. 6-12 S.I. Motor ... ..
195734	—	Armature, complete, for C.A.K. 6-14 S.I. Motor ... ..
195735	—	Armature, complete, for C.A.K. 6-15 S.I. Motor ... ..
195736	—	Field Core with Coils No. 195747, complete, for C.A.K. 6-3 S.I. Motor ... ..
195737	—	Field Core with Coils No. 195748, complete, for C.A.K. 6-5 S.I. Motor ... ..
195738	—	Field Core with Coils No. 195749, complete, for C.A.K. 6-6 S.I. Motor ... ..
195739	—	Field Core with Coils No. 195750, complete, for C.A.K. 6-7 S.I. Motor ... ..
195740	—	Field Core with Coils No. 195751 complete, for C.A.K. 6-8 S.I. Motor ... ..
195741	—	Field Core with Coils No. 195752, complete, for C.A.K. 6-9 S.I. Motor ... ..
195742	—	Field Core with Coils No. 195753, complete, for C.A.K. 6-10 S.I. Motor ... ..
195743	—	Field Core with Coils No. 195754, complete, for C.A.K. 6-11 S.I. Motor ... ..
195744	—	Field Core with Coils No. 195755, complete, for C.A.K. 6-12 S.I. Motor ... ..
195745	—	Field Core with Coils No. 195756, complete, for C.A.K. 6-14 S.I. Motor ... ..
195746	—	Field Core with Coils No. 195757, complete, for C.A.K. 6-15 S.I. Motor ... ..
195747	—	Field Coils assembled for 195736 ... ..
195748	—	Field Coils assembled for 195737 ... ..
195749	—	Field Coils assembled for 195738 ... ..
195750	—	Field Coils assembled for 195739 ... ..
195751	—	Field Coils assembled for 195740 ... ..
195752	—	Field Coils assembled for 195741 ... ..
195753	—	Field Coils assembled for 195742 ... ..
195754	—	Field Coils assembled for 195743 ... ..
195755	—	Field Coils assembled for 195744 ... ..
195756	—	Field Coils assembled for 195745 ... ..
195757	—	Field Coils assembled for 195746 ... ..
195832	2535	End Cover (pulley end) ... ..
195833	2535	End Cover (commutator end) ... ..
195834	2583	Controller Lead Terminal Eyelet for 195093 and 199016 ... ..
195834	2583	Singerlight Lead Terminal Eyelet for 196323 and 196359 ... ..
195868	—	Armature, complete, for C.A.K. 6-12 Motor

NUMERICAL LIST OF PARTS

69

No.	Plate	
195913	2535	Field Core Shield and Nameplate Insulation for 991601 ... ..
196323	—	Singerlight Lead, complete, Nos. 194525, 194526, 196324 and two 195834 for 199008
196324	—	Singerlight Lead for 196323 ... ..
196326	2583	Singerlight Shade for 199004 ... ..
196327	2583	Singerlight Toggle Switch Shell for 199005 and 199008 ... ..
196328	2583	Singerlight Lead Slot Cover for 199005 and 199008 ... ..
196330	2583	Singerlight Shade Insulating Bushing for 199004 ... ..
196341	—	Snap-on Switch Hole Plug Button ... ..
196342	2589	Arm Lead Guard ... ..
196354	2589	Three-Pin Terminal Box Cover for 196357 ... ..
196355	2583	Singerlight Lead Strain Relief Disc for 199005 and 199008 ... ..
196356	2589	Three-Pin Terminal Box Cover Insulating Lining (leatheroid) for 196357 ... ..
196357	—	Three-Pin Terminal Box Cover 196354 with 196356 ... ..
196358	2588	Three-Pin Terminal Box Insulation (leatheroid)
196359	2583	Singerlight Lead, complete, Nos. 194525, 194526, 196361 and two 195834 for 199005
196360	2588	Field Coil Lead Insulating Sleeve ... ..
196361	—	Singerlight Lead for 196359 ... ..
196363	2589	Bed Lead Guard Bushing for 196367 ... ..
196367	2589	Bed Lead Guard with 196363 ... ..
198051	2587	Two-Pin Plug Contact Pin for 198052 ... ..
198052	2587	Two-Pin Plug, complete, Nos. SS542, 193403 193404, two each SS541 and 198051 for V.D.E. and Norway ... ..
198168	2535	Field Coil Retainer ... ..
198178	2587	Three-Pin Terminal Body (male half) Terminal Post Nut for 199010 ... ..
198414	2538	Radio Interference Suppressor Lead Terminal Clip for 198838 ... ..
198837	2539	Radio Interference Suppressor only for 198838
198838	—	Radio Interference Suppressor, Nos 198837, 198924, 198926 and three 198414, for 198927 ... ..
198922	2539	Radio Interference Suppressor Pal Nut for 198927 ... ..
198923	2535	End Cover Fastening Screw (lower) for 198927
198924	2539	Radio Interference Suppressor Ground Lead Terminal Plug for 198838 ... ..

No.	Plate	
198925	2539	Radio Interference Insulating Plug for 198927
198926	2539	Radio Interference Suppressor Lead Insulating Tubing for 198838 ... ..
198927	2539	Radio Interference Suppressor, complete, Nos. 198838, 198922, 198923 and 198925
198954	2588	Three-Pin Terminal (female half) Housing Protection Sleeve (flat, flexible) for 198963
198960	2588	Three-Pin Terminal (female half) Housing Protection Sleeve (round, flexible) for 198999 ... ..
198963	2582	Three-Pin Terminal (female half), complete, Nos. 198967, 198968, two each 1768x, 51093x, 195059 and 198954 for 195092 ...
198967	—	Three-Pin Terminal (female half) Housing (upper) for 198963 ... ..
198968	—	Three-Pin Terminal (female half) Housing (lower) 198970 with three each 140125 and 195057, for 198963 ... ..
198970	—	Three-Pin Terminal (female half) Housing (lower) with three 195058, for 198968 ...
198995	2582	Controller, complete, for 32 to 55 volts, A.C. or D.C. Motor, Nos. 194321, 194569, 194573, 195092, 899287, two 964317, four each 140099x and 194407 ... ..
198995	—	Controller, complete, for 32 to 55 volts, A.C. or D.C. Motor, Nos. 194321, 194569, 194573, 199014, 899287, two 964317, four each 140099x and 194407 ... ..
198995	—	Controller, complete, for 32 to 55 volts, A.C. or D.C. Motor, Nos. 194321, 194569, 194573, 199014, 899287, two 964317, four each 140099x and 194407 ... ..
198996	—	Controller, complete, for 95 to 145 volts, A.C. or D.C. Motor, Nos. 194321, 194570, 194573, 195092, 199023, two 964317, four each 140099x and 194407 ... ..
198996	—	Controller, complete, for 95 to 145 volts, A.C. or D.C. Motor, Nos. 194321, 194570, 194573, 199014, 199023, two 964317, four each 140099x and 194407 ... ..
198996	—	Controller, complete, for 95 to 145 volts, A.C. or D.C. Motor, Nos. 194321, 194570, 194573, 199014, 899287, two 964317, four each 140099x and 194407 ... ..
198997	—	Controller, complete, for 150 to 250 volts, A.C. or D.C. Motor, Nos. 194321, 194571, 194573, 195092, 199024, two 964317, four each 140099x and 194407 ... ..

NUMERICAL LIST OF PARTS

71

No.	Plate	
198997	—	Controller, complete, for 150 to 250 volts, A.C. or D.C. Motor, Nos. 194321, 194571, 194573, 199014, 199024, two 964317, four each 140099x and 194407 ... ..
(Norway and V.D.E.)		
198997	—	Controller, complete, for 150 to 250 volts, A.C. or D.C. Motor, Nos. 194321, 194571, 194573, 199014, 199024, two 964317, four each 140099x and 194407 ... ..
(Denmark and Switzerland)		
198999	—	Three-Pin Terminal (female half) complete, Nos. 199000, 199001, two each 1768x, 51093x, 195059 and 198960 for 199014 ... ..
199000	—	Three-Pin Terminal (female half) Housing (upper) for 198999 ... ..
199001	—	Three-Pin Terminal (female half) Housing (lower) 199002 with three each 140125 and 195057 for 198999 ... ..
199002	—	Three-Pin Terminal (female half) Housing (lower) with three 195058 for 199001 ... ..
199004	2583	Singerlight (moulded, less lamp), complete, Nos. 64Lzj, 193437, 196326, 196330 and 199005 ... ..
(Great Britain and Australia)		
199004	2583	Singerlight (moulded, less lamp), complete, Nos. 64Lzj, 193437, 196326, 196330 and 199008 ... ..
(Switzerland, Norway and Denmark)		
199005	—	Singerlight Socket, complete, Nos. 196327, 196328, 196355, 196359, 199006, two each 50566 and 51385x, for 199004, for Great Britain and Australia ... ..
*199006	—	Singerlight Switch Mechanism, complete, Nos. 51399, 193254, 193256 to 193258, 194659, 199007, two each 51203, 193252, 193253 and 193267, for 199005 ... ..
*199007	—	Singerlight Socket Body, with 193255 and two 193251, for 199006 and 199009 ... ..
199008	—	Singerlight Socket, complete, Nos. 196323, 196327, 196328, 196355, 199009, two each 51290 and 51385x, for 199004, for Switzerland, Norway and Denmark ... ..
*199009	—	Singerlight Switch Mechanism, complete, Nos. 51399, 193257, 193258, 193634, 193635, 194659, 199007, two each 51203, 193252, 193253 and 193267, for 199008 ... ..
199010	2587	Three-Pin Terminal Body (male half), complete, Nos. 195048, three each 198178 and 701719 ... ..



No.	Plate	
199014	—	Controller Lead Cord, complete, from supply socket to three-pin terminal and controller, Nos. 198999, 199016, 199017 and Plug, for 198995 to 198997, for Norway, V.D.E., Denmark and Switzerland ... ..
199015	—	Controller Lead Cord (short) 3' 10", for 199016
199016	—	Controller Lead Cord 3' 10", complete, Nos. 194577, 194604, 199015, and two 195834, for 199014 ... ..
199017	—	Controller Lead Cord (long) 8', for 199014 ...
*199023	—	Name Plate for 198996, for Great Britain, Australia, Norway and V.D.E. ...
*199024	—	Name Plate for 198997 ... ..
200145c	2525	Rotating Hook Loop Guard Screw for 45829
200592c	2525	Rotating Hook Bobbin Case Tension Spring Screw for 45751 ... ..
200596f	2525	Rotating Hook Gib Screw for 45828 and 45829
200614c	2525	Rotating Hook Gib Hinge Screw for 45828 and 45829 ... ..
200964e	2525	Rotating Hook Bobbin Case Latch Stop Screw for 45751 ... ..
201016f	2525	Rotating Hook Bobbin Case Tension Spring Regulating Screw for 45751 ... ..
206731	2525	Rotating Hook Bobbin Case Latch Fulcrum Pin for 206736 ... ..
206735	2525	Rotating Hook Bobbin Case Latch for 206736
206736	2525	Rotating Hook Bobbin Case Latch 206735 with 206731 and 206737 for 45751 ...
206737	2525	Rotating Hook Bobbin Case Latch Lever for 206736 ... ..
210736	2525	Rotating Hook Bobbin Case Latch Spring for 45751 ... ..
701400	2535	Armature Shaft Thrust Washer (pulley end, phenolic)
701679	2587	Bed Lead Guard Fastening Screw Washer ...
701719	2587	Three-Pin Terminal Body (male half) Terminal Post Washer for 199010 ...
820343	2538	Field Coil Insulation ... ..
*899287	—	Name Plate for 198995 and 198996, for Denmark and Switzerland ... ..
931090	2538	Controller Resistance Unit Screw Washer (asbestos) for 194569 to 194571 ...
964270	2589	Three-Pin Terminal Box Cover Bushing (rubber) for Motor Leads ... ..
964317	2538	Name Plate Drive Screw for 198995 to 198997
†991601	2535	Field Core Shield and Name Plate ...

†When ordering, state motor with which it is to be used.

*Roller*

May, 1951

FORM K5779

(List of Parts for 221K1 Machine)

ALTERATIONS

Page 35—

45764 Alter to 45909, and delete plate

Page 39.—

192424 Alter to 196168, and delete plate

Numerical.—

45764 Obsolete, use 45909

192424 " " 196168

ADDITIONS

NUMERICAL SECTION

45909	—	Tension Releasing Lever	...	...
196168	—	Field Coil Retainer	...	...



www.Singer-Fe  
weight.com