

SINGER

FEATHERWEIGHT

model 221

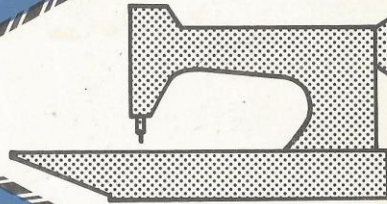

PORTABLE ELECTRIC SEWING MACHINE

THE SINGER COMPANY

www.Singer-Featherweight.com

IMPORTANT

"If the wires in the mains lead are coloured in accordance with the following code:

Blue	—	Neutral (N)
Brown	—	Live (L)

and do not correspond with the coloured markings identifying the terminals in your plug, proceed as follows:

The lead which is coloured brown must be connected to the terminal which is marked with the letter L or coloured red.

The lead which is coloured blue must be connected to the terminal which is marked with the letter N or coloured black."

SINGER*

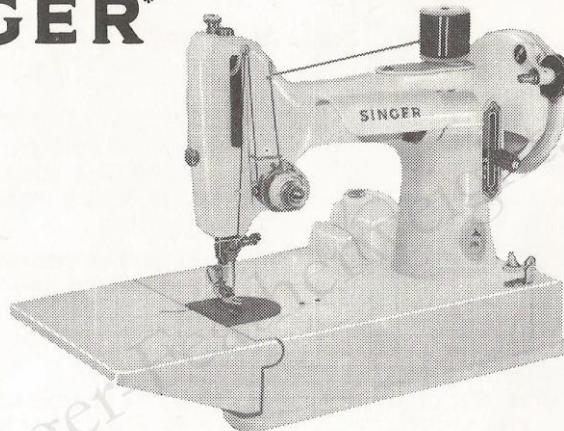

FEATHERWEIGHT*

Portable Electric Sewing Machine

© 1967 by The Singer Manufacturing Co., Ltd.
All rights reserved throughout the world.

*A Trademark of THE SINGER COMPANY

2

TABLE OF CONTENTS

	page		page
GETTING TO KNOW YOUR			
FEATHERWEIGHT	5	PREPARING TO SEW	21
PRINCIPAL PARTS	5	SEWING A SEAM	22
FIVE BASIC CONTROLS	7	TURNING A SQUARE CORNER	25
Electrical Controller	8	GUIDING & SUPPORTING FABRICS	26
Stitch Length Regulator	9	DARNING	27
Pressure Regulator	10	HOW TO USE THE ATTACHMENTS	28
Needle-Thread Tension Regulator	11	THE ZIPPER FOOT	29
Bobbin-Thread Tension Regulator	12	THE BINDER FOOT	31
HOW TO USE YOUR		THE SEAM GUIDE	34
FEATHERWEIGHT	13	FASHION AIDS	35
CHOOSING THE RIGHT NEEDLE,		THE BUTTONHOLER	35
THREAD, & STITCH LENGTH	13	THE EDGE STITCHER	36
INSERTING THE NEEDLE	14	THE GATHERING FOOT	36
THREADING	15	THE HEMMER FOOT	37
To Remove the Bobbin Case and		THE QUILTER	37
Bobbin	15	HOW TO TAKE CARE OF YOUR	
To Wind the Bobbin	16	FEATHERWEIGHT	38
To Thread the Bobbin Case	18	HINTS FOR HOME SERVICE	49
To Replace the Bobbin Case	19		
To Thread the Machine	20		

CONGRATULATIONS !

As the owner of a SINGER* Featherweight, you are about to enter a wonderful new world of sewing! From the moment you begin to sew on your Featherweight, you will be delighted with its easy, dependable operation.

May we recommend that, before you begin to sew, you discover all the many advantages of your Featherweight by going through this instruction



book step by step while seated at your machine.

If you are an experienced sewer, much of the information will be familiar to you. But whether you are experienced or not, we suggest that you get to know the book so that you will know where to find the answers to any questions you may have during the many years you will be enjoying your Featherweight.

SINGER SERVICE



Wherever you go you will find expert, dependable SINGER SERVICE close at hand. SINGER is interested in helping you keep your SINGER SEWING MACHINE in top running condition. That is why you should call your SINGER SEWING CENTRE if your machine ever requires adjustment or repair. Only from your SINGER SEWING CENTRE can you obtain the services of a trained SINGER repair man and warranted SINGER parts.

EVERYTHING FOR THE WOMAN WHO SEWS

The answer to your sewing needs is at your SINGER SEWING CENTRE. There you will find a wide choice of sewing aids, notions, sewing information and services. Look for the famous red "S" and SINGER trademarks on your SINGER SEWING CENTRE and the ever-ready SINGER SERVICE VAN. Look under SINGER SEWING MACHINE COMPANY, Ltd. in phone book, for address nearest you.

GETTING TO KNOW YOUR FEATHERWEIGHT

PRINCIPAL PARTS

1. **Pressure Regulator**—controls pressure of presser foot on fabric.
2. **Take-Up Lever**—controls needle thread.
3. **Presser Foot Lever**—raises and lowers presser foot.
4. **Needle-Thread Tension Regulator**—tightens and loosens needle thread.
5. **Thread Cutter**. Slot on back of bar cuts thread easily, safely.
6. **Presser Foot**—holds fabric against feed dog.
7. **Bed Extension**—lifts up for easy access to bobbin.
8. **Feed Dog**—moves fabric as it is being stitched.
9. **Throat Plate**. Numbered lines show seam width in 1/8-inch gradations. Arrow reminds you to thread from right to left.
10. **Electrical Controller**.
11. **Bobbin-Winding Thread Guide**.
12. **Light Switch**.
13. **Stitch Length Regulator**—controls number of stitches per inch, forward and in reverse.
14. **Motor Belt**—activates machine.
15. **Bobbin Winder**.
16. **Hand Wheel**—controls take-up lever. Always turn it toward you.
17. **Spool Pin**. Wire coil keeps spool steady; felt disc keeps it silent.
18. **Light**—pours light on sewing area.
19. **Motor**.

PRINCIPAL PARTS OF FEATHERWEIGHT

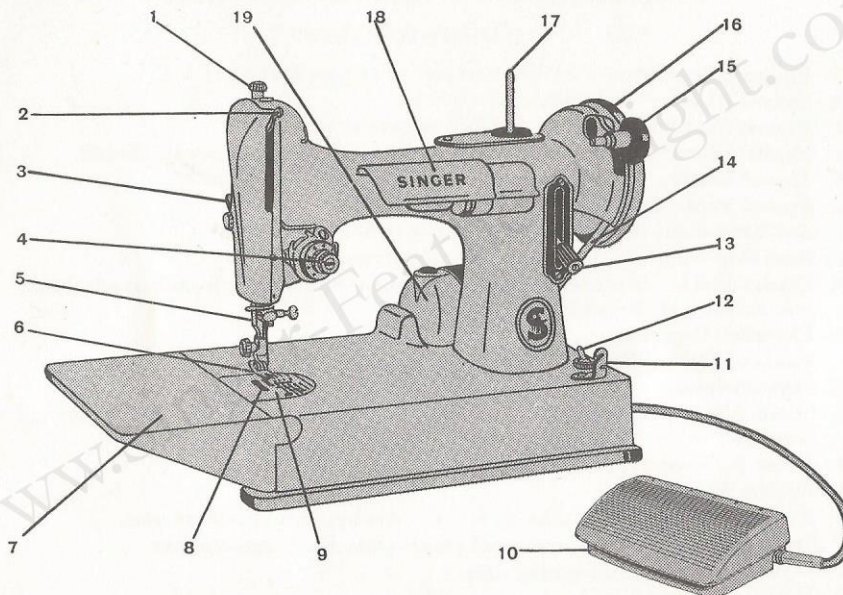

FIVE BASIC CONTROLS

Your Featherweight has five basic controls that enable you to direct the machine to sew just as you want it to. You will use some of these controls every time you sew; others, only occasionally. We suggest that you get acquainted with all of them now, however, so that you will be ready to use them with ease as the need arises.

- No. 1 **Electrical Controller**
- No. 2 **Stitch Length Regulator**
- No. 3 **Pressure Regulator**
- No. 4 **Needle-Thread Tension Regulator**
- No. 5 **Bobbin-Thread Tension Regulator**

No. 1 Electrical Controller

Let us begin with the control that makes the machine go.

Before you put the plug in your wall outlet, be sure that the voltage and number of cycles (stamped on the plate on top of the motor) are within the range marked on the electric meter installed by your power company.

Speed Controller. Speed of machine is regulated by amount of pressure on pedal of foot controller.

SAFETY: DISCONNECT PLUG FROM ELECTRICITY SUPPLY WHEN MACHINE IS NOT IN USE.

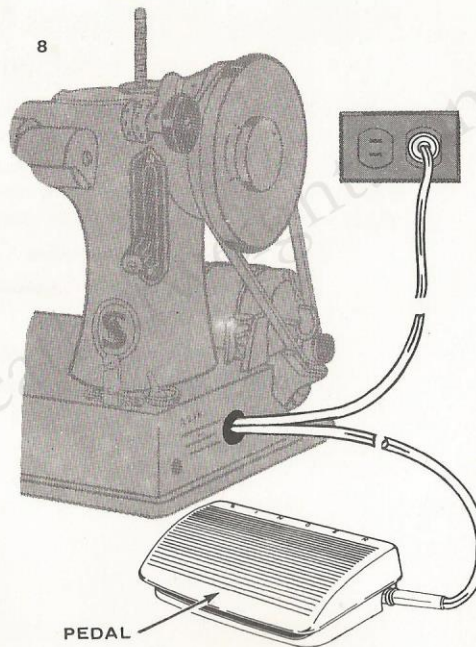

FIVE BASIC CONTROLS—Continued

No. 2. Stitch Length Regulator

The numbers on either side of the lever represent the approximate number of stitches per inch. The higher the number, the shorter the stitch.

In general, lightweight fabrics require short stitches (a high number setting) and heavyweight fabrics require longer ones (a low number setting).

To set stitch length—

1. Loosen thumb nut by turning it to the left.
2. Move lever to desired stitch length setting.
3. Tighten thumb nut by turning it to the right until it touches the numbered indicator plate.

To stitch in reverse—

1. Set stitch length and tighten thumb nut.
2. Raise lever as far as it will go.

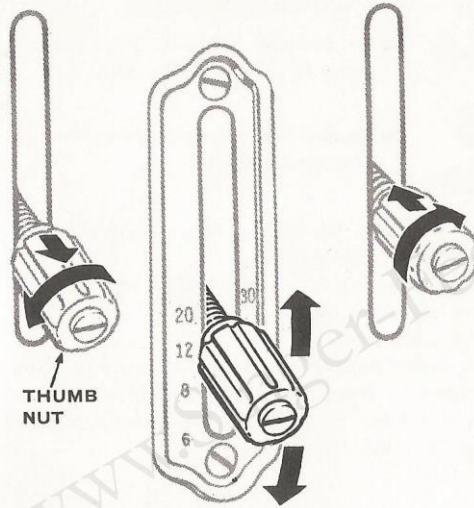

No. 3 Pressure Regulator

● To increase pressure, turn thumb screw in clockwise direction.

● To decrease pressure, turn screw in anti-clockwise direction.

This screw regulates the degree of pressure that the presser foot exerts on the fabric.

Pressure should be heavy enough to prevent the fabric from slipping sideways and light enough to carry the fabric without marking it.

In general, heavy fabrics require heavier pressure than lightweight fabrics. But surface finish and fabric texture must also be considered: crisp fabrics, for example, require more pressure than soft fabrics.

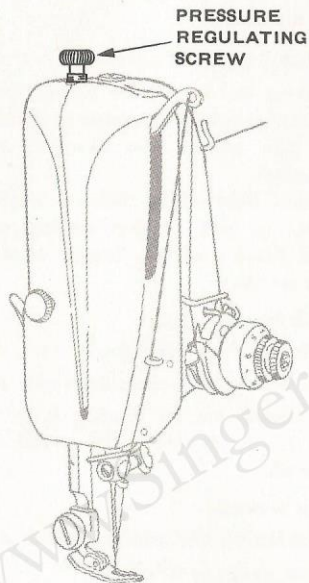

FIVE BASIC CONTROLS—Continued

No. 4 Needle-Thread Tension Regulator

The numbers on the dial represent the degree of tension on the needle thread. The **higher** the number, the **tighter** the thread.

Correct needle-thread tension is important because too tight a thread will cause fabric to pucker. Too loose a thread, on the other hand, will produce slack stitches and weak seams.

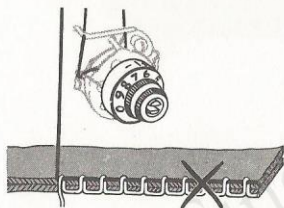

Needle-thread tension too tight—correct by setting dial to lower number.

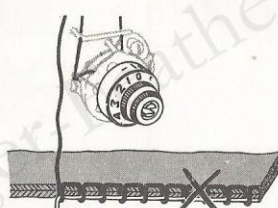

Needle-thread tension too loose—correct by setting dial to higher number.

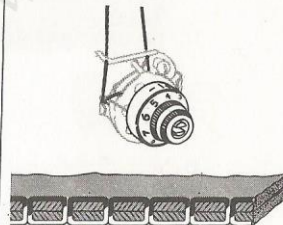

A perfectly locked stitch results with upper and lower tensions balanced so that needle and bobbin threads are drawn equally into fabric.

No. 5 Bobbin-Thread Tension Regulator

This “regulator” is simply a screw on the bobbin case. (For instructions on removing bobbin case, see page 15). A very slight turn of the screw nearer the thread slot on the bobbin case will produce a noticeable change in bobbin-thread tension.

You will seldom need to adjust bobbin-thread tension. Usually it is possible to obtain correct tension by adjusting the needle-thread tension alone.

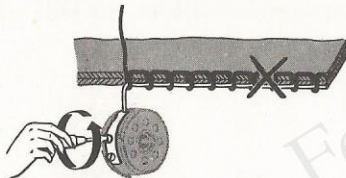

Bobbin-thread tension too tight—correct by turning screw counter-clockwise.

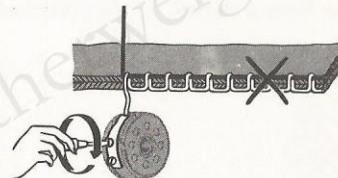

Bobbin-thread tension too loose—correct by turning screw clockwise.



A perfectly locked stitch results with upper and lower tensions balanced so that needle and bobbin threads are drawn equally into fabric.

HOW TO USE YOUR FEATHERWEIGHT CHOOSING THE RIGHT NEEDLE, THREAD, AND STITCH LENGTH

Your Featherweight will stitch perfectly on almost any kind of fabric. All you have to do is choose the right needle, thread, and stitch length. Use the table below to make sure that you will get perfect results every time.

FABRICS	THREAD SIZES	NEEDLE SIZES	MACHINE STITCHES PER INCH STRAIGHT STITCHING
DELICATE—tulle, chiffon, fine lace, silk, organdie, fine tricot	60 Mercerized 100 Cotton Fine Synthetic Thread	9	15 to 20
LIGHTWEIGHT—batiste, organdie, Jersey, voile, taffeta, silk, crepe, plastic	50 Mercerized 80 to 100 Cotton Pure Silk Synthetic Thread	11	12 to 15 (8 to 10 for plastic)
MEDIUM WEIGHT—gingham, man-made fabric, pique, linen, chintz, faille, satin, fine corduroy, suitings, cotton-backed plastic	50 Mercerized 60 to 80 Cotton Pure Silk Synthetic Thread	14	12 to 15
MEDIUM HEAVY—gabardine, tweed, sailcloth, denim, coatings, furnishing fabrics	40 Mercerized 40 to 60 Cotton	16	10 to 12
HEAVY—overcoatings, twill, upholstery fabrics, canvas	36 Mercerized 24 to 40 Cotton	18	8 to 10

INSERTING THE NEEDLE

1. Turn hand wheel toward you to raise take-up lever to its highest point.
2. Loosen needle-clamp screw by turning it toward you.
3. Hold needle with flat side to left and push it up into the needle clamp as far as it will go.
4. Tighten clamp screw.

This machine uses needle Catalogue No. 2020 (15 x 1) Sizes 9, 11, 14, 16, and 18.

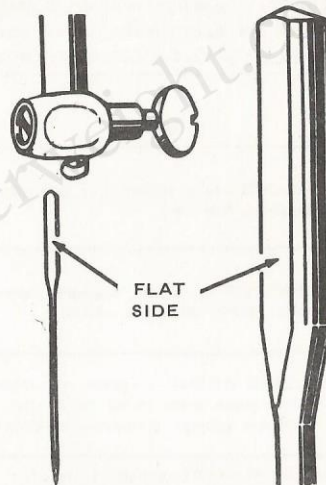

THREADING

When you prepare to sew, wind the bobbin first, then thread the machine.

To Remove the Bobbin Case and Bobbin—

1. Turn hand wheel toward you to raise take-up lever to its highest position.
2. Raise bed extension.
3. Grasp bobbin-case latch and withdraw bobbin case.
4. Release latch and bobbin will drop out of case.

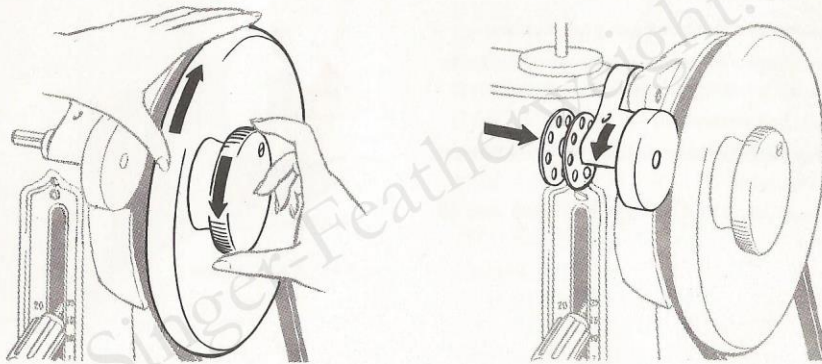
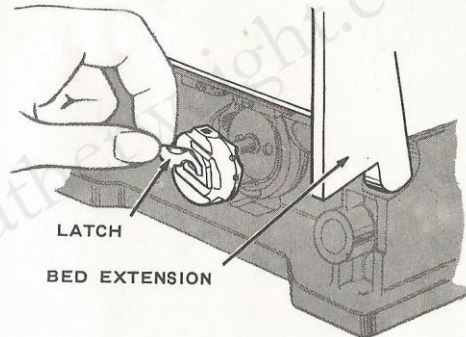
**To Wind The Bobbin—**

1. Loosen stop-motion screw with right hand while holding hand wheel with left hand.
2. Place empty bobbin on bobbin-winder spindle.
3. Press bobbin winder down against motor belt.

THREADING—Continued

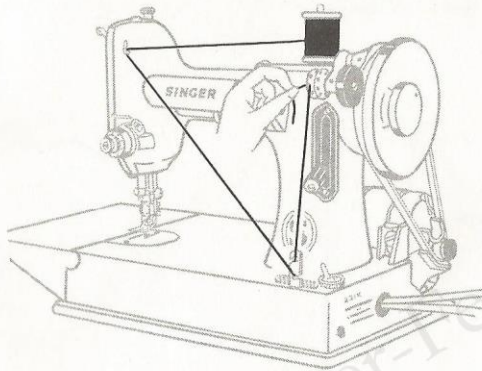

To Wind the Bobbin—Continued

4. Place spool of thread on spool pin.
5. Thread machine and bobbin as shown above.
6. Hold thread end and start machine. (End of thread will break off after a few coils have been wound on bobbin.)

7. When bobbin is full, stop machine.
8. Cut thread.
9. Lift bobbin winder away from belt and remove bobbin.
10. Tighten stop-motion screw.

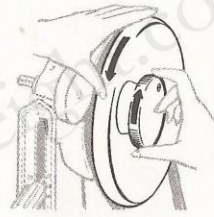

If Thread Does Not Wind Evenly on Bobbin—

1. Loosen screw that holds bobbin-winding thread guide (reverse "S") on bed of machine.
2. Move thread guide to left if thread winds high on right of bobbin.
3. Move thread guide to right if thread winds high on left of bobbin.
4. Tighten thread guide screw.

To Thread the Bobbin Case—

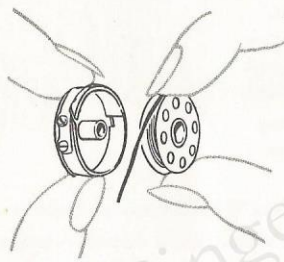

1. Hold bobbin case and bobbin so that thread leads off in direction shown above.

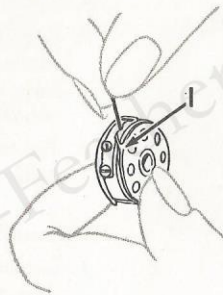

2. Place bobbin into bobbin case. Pull thread into slot (1).

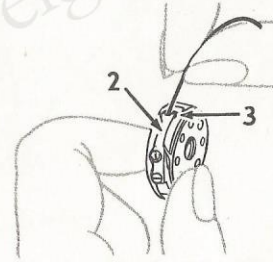

3. Pull thread under tension spring (2) and into slot (3) at end of spring, as shown.

THREADING—Continued
To Replace the Bobbin Case—

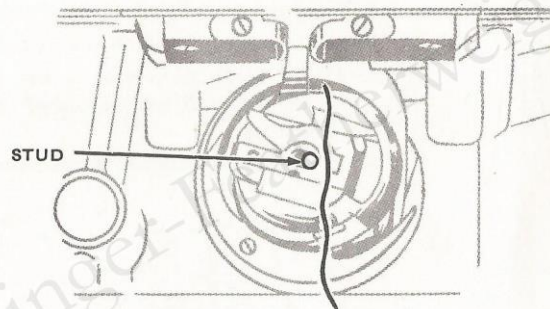

1. Hold bobbin case by latch, with thread leading off top of case.
2. Slide case on to stud as far as it will go.
3. Release latch, and allow about 3 inches of thread to hang free from bobbin case.

To Thread the Machine—

1. Turn hand wheel toward you to raise take-up lever to its highest position.
2. Place spool of thread on spool pin.
3. Lead thread through threading points shown.
4. Thread needle from right to left. (The arrow on the throat plate will remind you of the correct threading direction.)
5. Draw about 3 inches of thread through the needle.

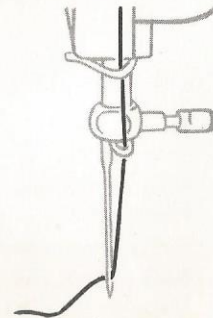
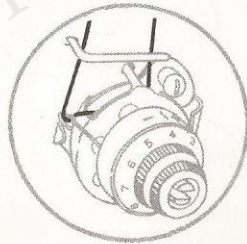
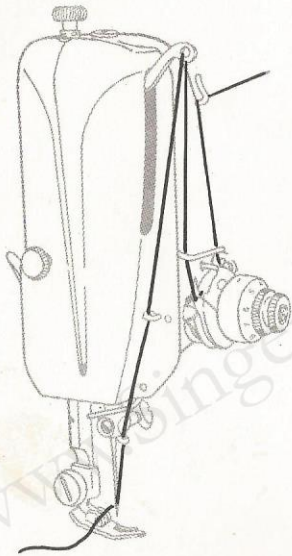

PREPARING TO SEW

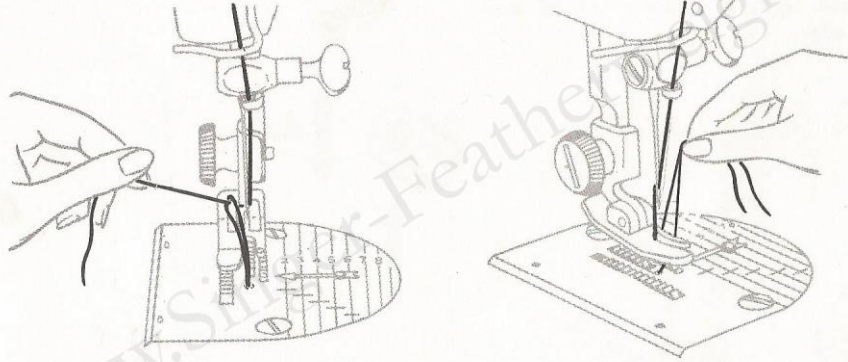

1. Have take-up lever at its highest position.
2. Hold needle thread lightly with left hand.
3. Turn hand wheel so that needle enters plate and brings up bobbin thread in loop.
4. Untie loop with finger and lay both threads diagonally under presser foot.

SEWING A SEAM

1. Set stitch regulator for desired stitch length.
2. Position needle in fabric about 1/2 inch from edge.
3. Raise stitch regulator to reverse.
4. Lower presser foot.

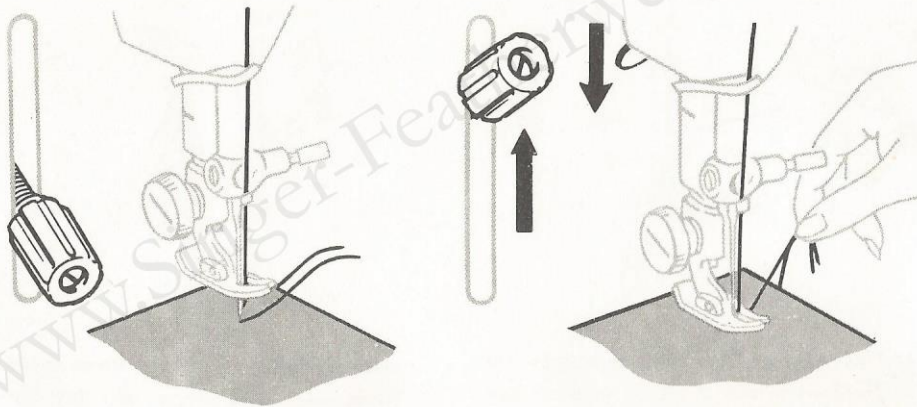

SEWING A SEAM—Continued

5. Backstitch to edge of fabric for reinforcement. 6. Lower stitch regulator for forward stitching of seam.

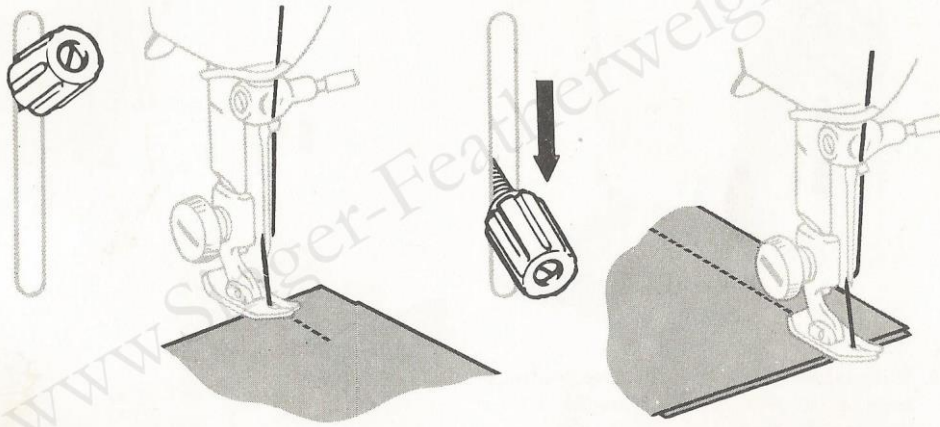

SEWING A SEAM—Continued

7. When you reach the end of the seam, raise stitch length regulator and backstitch to reinforce seam.

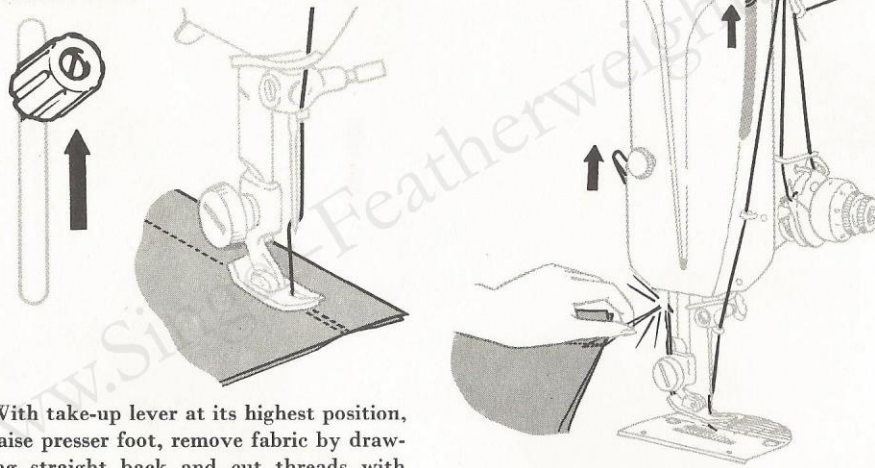

8. With take-up lever at its highest position, raise presser foot, remove fabric by drawing straight back and cut threads with thread cutter as shown.

TURNING A SQUARE CORNER

If you wish to stitch a square corner, the guidelines on the throat plate will enable you to make a perfect right angle without measuring. (Each short horizontal line represents the same distance from the needle as the vertical line it crosses.) Suppose, for example, that you wish to make a square corner on a $\frac{5}{8}$ -inch seam:

1. Line up fabric edge on guideline 5.
2. Stitch until the bottom edge of the fabric is on the horizontal line that crosses guideline 5.
3. Stop the machine as the needle is entering the fabric.
4. Raise presser foot.
5. Pivot the fabric counterclockwise: again line up seam edge with guideline 5.
6. Lower presser foot and continue stitching.

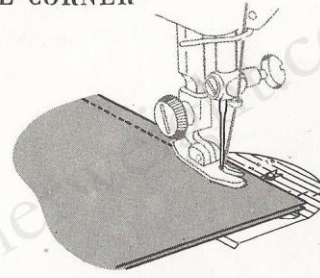

Before Pivoting

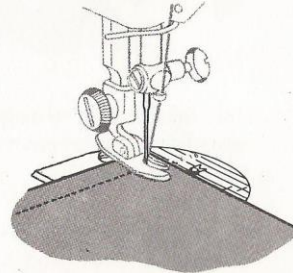

After Pivoting

GUIDING AND SUPPORTING FABRICS

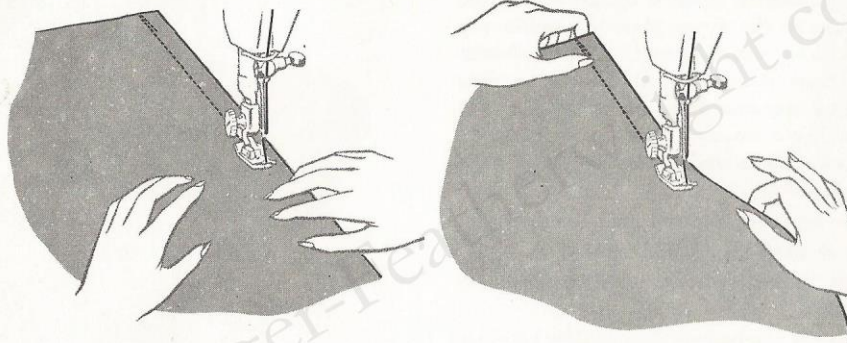

Most fabrics need to be guided in front of the presser foot only, as shown at left. Some fabrics, however, require support while being stitched:

- For filmy sheers, knits, tricots, etc., apply **gentle tension** by holding seam in front and back of the presser foot.
- For stretch fabrics, apply **firm tension** front and back when stitching in the same direction as the "stretch". For seams not on the "stretch" direction, stitch in conventional manner, guiding fabric in front of presser foot.

DARNING

With just a little practice you will be able to darn clothing and household linens effortlessly and quickly on your Featherweight.

1. Adjust Stitch Length Regulator for desired stitch length (usually about 10 or 12).
2. Decrease pressure by turning Pressure Regulator thumb screw anti-clockwise. Pressure should be lighter than for normal sewing but not too light to prevent work from feeding smoothly.
3. If area to be darned is open, baste an underlay in place.
4. Place area to be darned under presser foot.
5. Lower presser foot and start stitching, alternately letting fabric feed normally away from you and then gently pulling fabric toward you. Continue this forward and backward motion until area to

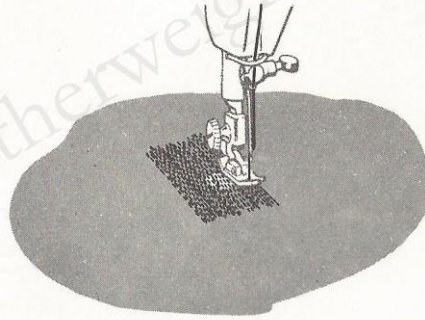

be darned is filled with parallel lines of stitching.

6. For additional strength, turn fabric and cover area with crosswise lines of stitching.

HOW TO USE THE ATTACHMENTS



The attachments that come with your Featherweight are designed to help you do tricky sewing jobs with ease. Resist the temptation to hide them in the back of your sewing drawer!

THE ZIPPER FOOT

(Part No. 161127)

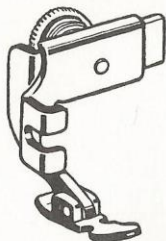

The narrow Zipper Foot makes it easy to place stitching close to a raised edge—either a zipper or cording. Also, the hinge in the foot makes it ride easily over pins, heavy layers of fabric, or cross seams.

Use the Zipper Foot for—

Zipper Insertions
Tubular Cording
Corded Seams
Slipcover Welting

To Attach the Zipper Foot—

1. Loosen the large screw at the left of the presser bar and remove presser foot. (You do not need to remove the screw.)
2. Hook the prongs of the Zipper Foot around the presser bar from the back, and tighten the presser-bar screw.
3. If the raised edge (zipper or cording) is to the **right** of the needle, adjust the Zipper Foot by loosening the thumb screw at the back of the foot and sliding foot to the **left** of the needle. If the raised edge is to the **left**, slide foot to **right**.
4. With presser foot down, check its position by lowering needle into side notch, making sure it just clears the foot.
5. Tighten thumb screw to lock foot into position.

Zipper Insertion

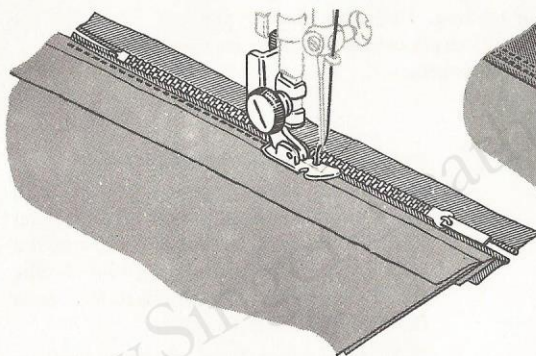

Corded Seams

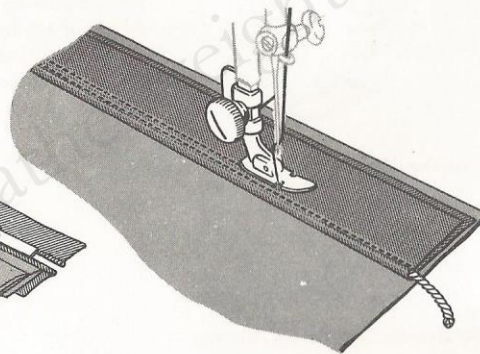

● When raised edge is placed to right—
adjust foot to left of needle.

● When raised edge is placed to left—
adjust foot to right of needle.

THE BINDER FOOT (Part No. 121464)

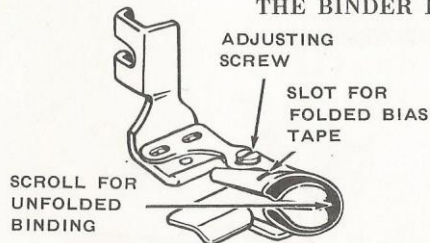

With the Binder Foot, you can apply bias binding to an unfinished edge in a single operation. Such binding can be a colourful trim for children's clothes, aprons, or household textiles. Or it can be a practical finish for seam edges that might ravel.

If you buy ready made binding use that which measures 5/8 inch wide. This may be purchased from any Singer Sewing Centre, is specially made for use in the binder and is available in a good range of colours. If you make binding yourself be sure to cut it one inch wide to allow for turnings.

To Attach the Binder Foot—

1. Loosen the large screw at the left of the presser bar and remove the presser foot. (You do not need to remove the screw.)

2. Hook the prongs of the Binder Foot around the presser bar from the front, and tighten the presser-bar screw.

To Apply Binding—

1. Cut end of binding diagonally to form a long point (as you would cut a ribbon).
2. If the binding is folded, insert pointed end (from the outside of the scroll) into the slot and pull it through the scroll until evenly folded edges are under the needle.

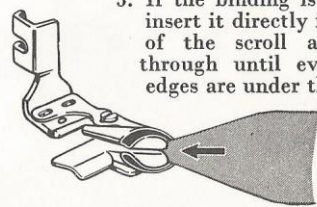
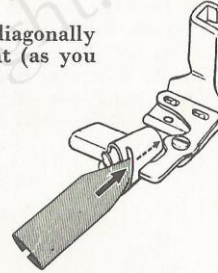

3. If the binding is **not** folded, insert it directly into the end of the scroll and pull it through until evenly folded edges are under the needle.

THE BINDER FOOT—Continued

4. Insert edge to be bound in centre slot of scroll.
5. Position needle in fabric, lower presser foot, and stitch.

Never pull binding as it feeds through the scroll. Let the Binder Foot do the work. Just guide the edge to be bound into the centre of the scroll as you stitch.

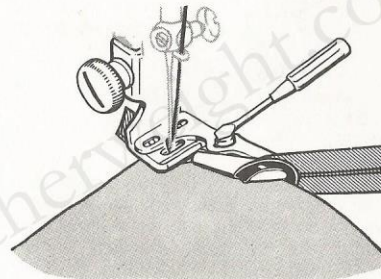
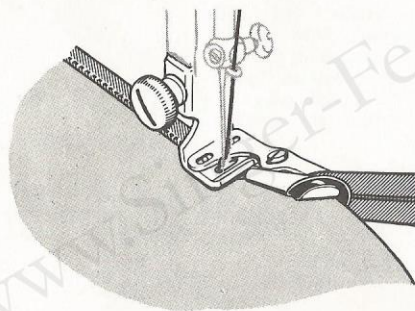
**To Adjust Binder Foot—**

To position stitching in relation to the binding edge, adjust the Binder Foot.

1. Loosen adjusting screw.
2. Move scroll to right or left as necessary.
3. Tighten adjusting screw.

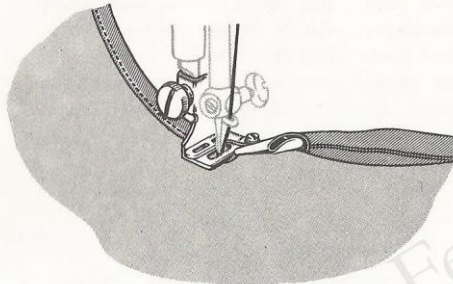

INSIDE CURVE

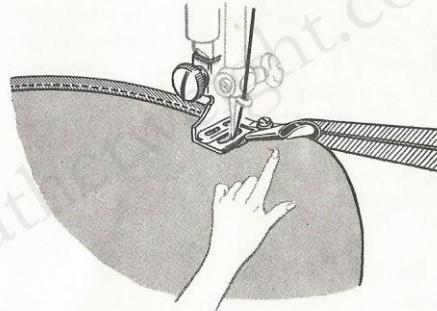

OUTSIDE CURVE

To Bind Curved Edges—

Curved edges require slightly different fabric handling from straight edges. Inside curves should be straightened as they are fed into binder. If fabric is soft and has a tendency to stretch, reinforce edge with a single row of stitching before binding.

Outside curves tend to lead away from centre slot of scroll and should be guided so that a full seam width is taken at needle point. Do not attempt to pull or straighten fabric into full length of scroll.

THE SEAM GUIDE (Part No. 25527)

(Part No. 25527)

50053
(Screw)

The Seam Guide will help you stitch seams of perfectly uniform width. It is especially useful for hard-to-handle fabrics or for curved seams. When you use it, you can place stitching at any distance between $\frac{1}{8}$ inch and $1\frac{3}{8}$ inch from the edge of the fabric.

Use the Seam Guide for—

- Seams
- Stay Stitching
- Top Stitching - Single or Multiple Rows

To Attach the Seam Guide—

Place screw in either of the two holes to the right of the slide plate.

SEAMS

For straight seams. Align guide with presser foot. Pin seam edges and baste if necessary. Guide fabric edges lightly against guide while stitching.

For curved seams: Set attachment at an angle so that end closer to needle acts as a guide. Shorten stitch length for greater elasticity and strength.

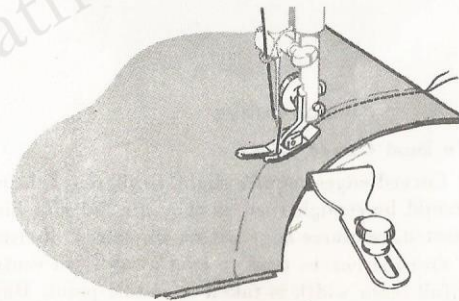

FASHION* AIDS

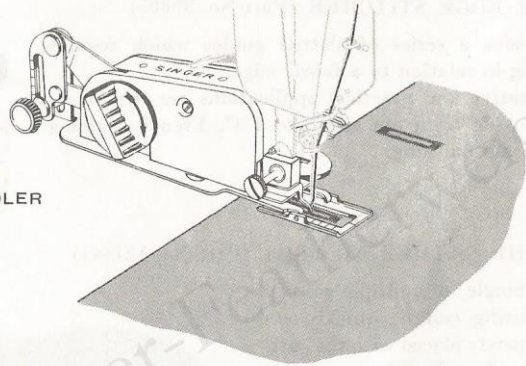

THE BUTTONHOLER
(Part No. 86718)

This attachment produces neat and durable buttonholes in a great variety of fabrics without any special skill on the part of the operator. The buttonholes are produced in a fraction of the time required for hand work and they are firmer and more even than those made by hand.

The attachment can be adjusted to make buttonholes from $\frac{3}{8}$ to one inch long and the spacing of stitches, width of stitch and amount of cutting space can also be changed at will. When desired, buttonholes longer than one inch can also be made by following the instructions supplied with the attachment.

*Fashion Aids are available for purchase at your local SINGER SEWING CENTRE.

THE EDGE STITCHER (Part No. 36865)

This attachment provides a series of slotted guides which regulate the placement of stitching in relation to a fabric edge.

Among its many decorative and practical applications are the joining and insertion of lace, tucking from pin width to $\frac{1}{4}$ ", French seaming, seam piping, facing and seam finishing.



THE GATHERING FOOT (Part No. 121441)

Single or multiple rows of shirring can be quickly and expertly placed with the gathering foot. Evenly spaced shirring is insured as this foot is designed to lock fullness into every stitch.



Use the Gathering Foot for—

Plain shirring	Waffle shirring
Elastic shirring	Machine smocking

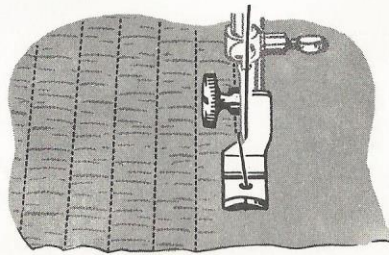

FASHION AIDS—Continued

THE HEMMER FOOT
(Part No. 120842)



The Hemmer Foot forms a perfectly turned hem without basting or pressing.

It can be used for—

- Fine Hems
- Ruffle Edges
- Hemmed Seams
- Lingerie Finishes

THE QUILTER (Part No. 35932)

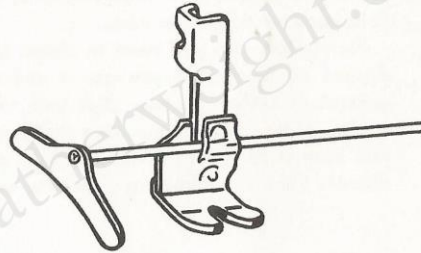

The Quilter is excellent for the placement of stitching in block, floral or scroll designs and is especially well adapted to stitching lightly padded materials. The short open foot permits following curved lines with ease and accuracy; the adjustable space guide placed to the right or left of the needle keeps rows of stitching parallel.

HOW TO TAKE CARE OF YOUR FEATHERWEIGHT

Your Featherweight is a fine yet sturdy precision instrument, and it will serve you perfectly for many years if you take a few simple steps to keep it in good working condition.

How often you will need to clean, oil, and lubricate your machine will depend on how often you use it and where you keep it. The following general guidelines assume that you will be sewing two or three times a week. If you use the machine continuously, clean and oil it daily. Or, if you keep it in a very warm or damp place, oil and lubricate it more frequently than the following guidelines suggest.

THE MOTOR REQUIRES NO LUBRICATION

EVERY WEEK OR SO—

Remove lint and fluff from working parts. As a matter of fact, you will be able to see the lint and fluff on these parts, and we recommend that you remove them as they accumulate.

With a soft cloth, clean:

- Between tension discs.
- Area around needle and presser foot.
- Take-up lever and thread guides.
- Bobbin case. (For instructions on removing bobbin case, see page 15).

With a soft brush, clean:

- Bobbin-case area.
- Feed dog. (Remove throat plate first).

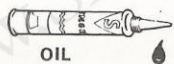

OIL

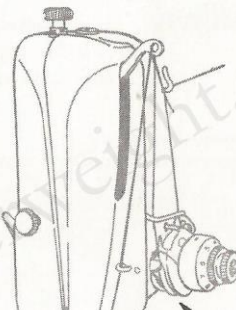
CLEAN
BETWEEN
TENSION
DISCS

CLEAN

CLEAN
AND
OIL

EVERY WEEK OR SO—Continued

CAUTION: Make certain, when replacing throat plate that position finger of bobbin-case base enters notch of position plate attached to underside of throat plate, as shown below.

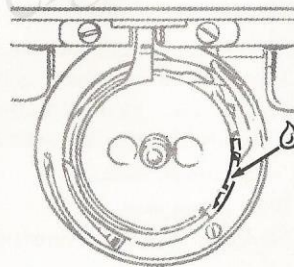
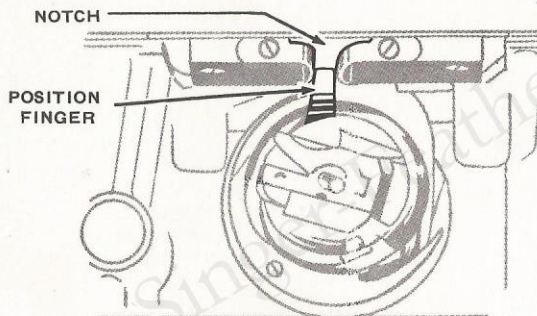

After cleaning the bobbin-case area, apply a drop of SINGER oil, as shown.

EVERY FEW MONTHS—

1. Clean and oil the parts behind the face plate.
 - To remove face plate, turn hand wheel until take-up lever reaches its highest point.
 - Then remove face-plate thumb screw, raise face plate and carefully pass it toward you over end of take-up lever.
 - Brush lint and fluff away and apply a drop of SINGER oil to each spot indicated.
2. Clean and oil the top and back of the machine.

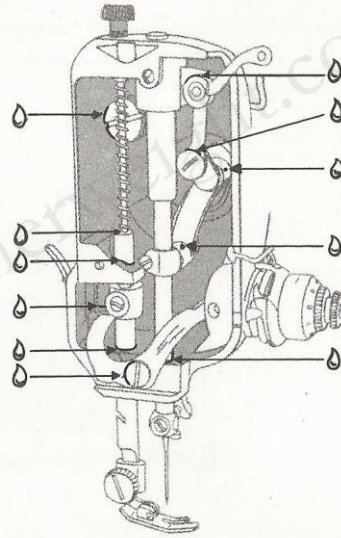
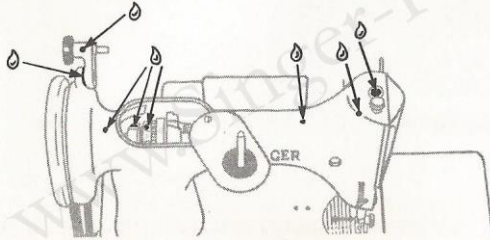

EVERY SIX MONTHS—

- Clean and oil the underside of the machine. ● Apply SINGER oil to spots indicated.
- Remove screw and cover plate from underside of machine.
 - Replace bottom cover.

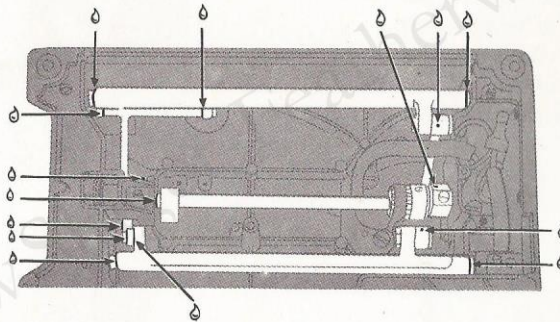

DISCONNECT PLUG FROM ELECTRICITY SUPPLY BEFORE REMOVING BOTTOM COVER

IF THE MACHINE IS TO BE STORED—

- Brush away all traces of lint and fluff.
- Swab all exposed parts with a soft, lint-free brush saturated with SINGER oil to protect against rust damage.
- Swab parts behind face plate with oil.

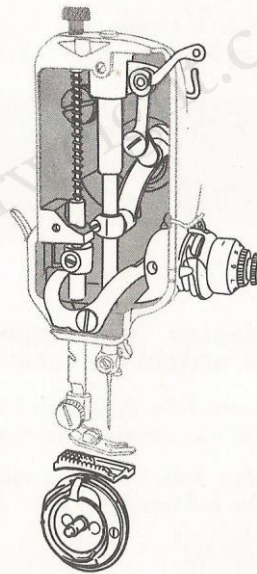

CHANGING THE LIGHT BULB—

The light is turned "on" or "off" by the switch located on bed of machine at the right.

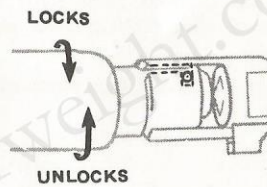
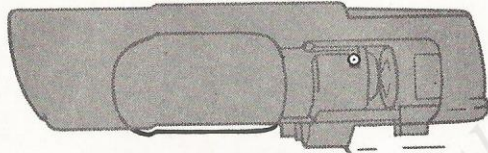

DISCONNECT PLUG FROM ELECTRICITY SUPPLY BEFORE CHANGING BULB.

To Remove Bulb. Press bulb into socket and turn it in "unlock" direction, as shown, and withdraw.

To Replace Bulb. Press bulb into socket with bulb pin in slot and turn it in "lock" direction, as shown.

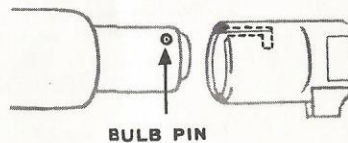

ADJUSTING BELT TENSION—

On rare occasions, you may find it necessary to adjust the tension on the motor belt. Tension on the belt should be just strong enough to keep the belt from slipping. If the belt is too tight, the machine will run slowly.

This will overload and possibly damage motor.

To Adjust—

1. Loosen bracket screw (A) a full turn.
2. Allow weight of motor to supply correct belt tension.
3. Tighten bracket screw.

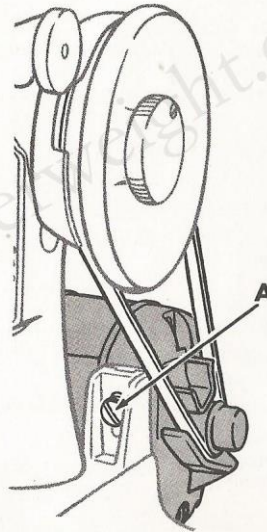

INDEX

	page		page
Attachments	28-34	Hints, Home Services	49-54
Binder Foot	31-33	Light Bulb	
Seam Guide	34	To Change	44
Zipper Foot	29-30	Principal Parts of Featherweight	6
Belt		Maintenance of the Machine	
To Adjust Belt Tension	45	Oiling and Lubrication	41-43
Bobbin		To Clean the Machine	39
Removing	15	Needle Insertion	14
Winding	16-17	Pressure Adjustment	10
Bobbin Case		Sewing	
Removing	15	Guiding and Supporting Fabric	26
Replacing	19	Preparing to Sew	21
Threading	18	Sewing a Seam	22-24
Chart for Fabric, Thread, Needle		To Regulate Length of Stitch	9
and Stitch Length	13	Threading	
Darning	27	Bobbin Case	18
FASHION Aids		Needle	20
Buttonholer	35	Thread Tensions	
Edge Stitcher	36	Bobbin Thread	12
Hemmer Foot	37	Needle Thread	11
Gathering Foot	36		
Quilter	37		

Hints for Home Service

see following pages

49

HINTS FOR HOME SERVICE SINGER SEWING MACHINE—MODEL 221

Whenever sewing difficulties are encountered, review the sections of the instruction book that pertain to the operation that you are performing, to assure you are using the machine properly. If the problem still exists, the following hints will help you to correct it:

Fault—Machine does not sew.

Symptom	Remedy
a. Needle bar does not move.	<ol style="list-style-type: none">1. Make sure that motor is connected to electrical supply or treadle belt is engaged.2. Make sure that clamp stop motion is tightened (see pages 16 and 17).
b. Needle bar moves but machine does not stitch.	<ol style="list-style-type: none">1. Replace needle. Make sure proper needle class and size is used (see page 13); make sure the needle is properly inserted (see page 14) and check to see if machine is threaded properly (see pages 17 and 18).2. Make sure that bobbin case and bobbin are properly placed in machine (see page 15).3. Make sure that bobbin case area is free of lint.

Fault—Machine does not sew.

Symptom	Remedy
c. Needle bar moves and stitches but fabric does not move.	<ol style="list-style-type: none"> 1. Make sure feed regulator is set to desired stitch length (see page 9). 2. Make sure there is sufficient presser bar pressure to hold material (see page 10). 3. Remove throat plate and clean all lint from around feed dog (see pages 39 and 40).
d. Needle breaks.	<ol style="list-style-type: none"> 1. Replace needle, making sure it is the proper class and size and make sure it is properly inserted (see pages 13 and 14). Turn handwheel over by hand several times to make sure needle does not foul throat plate, presser foot or attachment. 2. If material is being guided behind the needle (see page 26), make sure that it is not being pulled too quickly. 3. Make sure that presser foot or attachment is securely fastened to presser bar. 4. Do not pull the material to one side when taking it from the machine. The needle may become bent and strike the throat plate or presser foot (see page 24).

Fault—Thread breaks.

Symptom	Remedy
a. Needle thread failures.	<ol style="list-style-type: none"> 1. Needle might be bent. Replace needle making sure it is the proper class and size (see page 13) and make sure it is properly inserted (see page 14). 2. Make sure the machine is properly threaded (see page 20). 3. If the needle thread tension is too tight it should be made lighter (see page 11). 4. Check needle hole in throat plate and presser foot to ensure that they have not been damaged. 5. Make sure bobbin and bobbin case are properly inserted in machine (see page 15). 6. Make sure that threads are properly placed under presser foot when starting to sew (see page 21).
b. Bobbin thread failures.	<ol style="list-style-type: none"> 1. Make sure bobbin is wound properly (see pages 16 and 17). 2. Make sure bobbin case is threaded and inserted properly (see pages 18 and 19). 3. Check to make sure bobbin or bobbin case have not been damaged.

Fault—Skipped Stitches.

Symptom	Remedy
Failure to consistently make stitches.	<ol style="list-style-type: none"> 1. Needle might be bent. Replace needle, making sure it is the proper class and size (see page 13) and make sure it is properly inserted (see page 14). 2. Make sure that machine is threaded properly (see pages 18 to 20). 3. Make sure that material is held down firmly (particularly when doing darning or embroidery).

Fault—Looped Stitches.

Symptom	Remedy
Loose stitches occurring on underside of fabric.	<ol style="list-style-type: none"> 1. Needle might be burred. Replace needle, ensuring that it is the proper class and size (see page 13) and make sure it is properly inserted (see page 14). 2. If needle thread tension is too loose, it should be tightened (see page 11). 3. Make sure bobbin case area is free of lint. 4. Make sure the bobbin is not wound too full (the thread should be below the edge of the sides).

Fault—Gathering or puckering of material.

Symptom	Remedy
Material does not lie flat after sewing.	<ol style="list-style-type: none"> 1. Needle might be bent. Replace needle, making sure it is the proper class and size (see page 13) and make sure it is properly inserted (see page 14). 2. If needle or bobbin thread tension is too tight it should be made lighter (see pages 11 and 12). 3. Make sure there is sufficient presser bar pressure to hold material (see page 10). 4. Stitch length may be too long for material (particularly fine materials). 5. Make sure proper presser foot is being used.

Fault—Incorrect Feeding.

Symptom	Remedy
Material does not move properly under presser foot.	<ol style="list-style-type: none"> 1. Presser bar pressure may be too light (see page 10). 2. Presser foot or attachment may not have been properly re-assembled to presser bar. 3. Feed regulator may not be set to proper stitch length (see page 9). 4. Remove throat plate and make sure lint has not accumulated on feed dog.

Fault—Sluggish and/or noisy machine.

Symptom	Remedy
Handwheel difficult to turn over manually and/or machine noise level has increased.	<ol style="list-style-type: none"> 1. All lint should be cleaned from machine, particularly in area of bobbin case. 2. All oiling points should be oiled (see pages 39 to 43). Singer sewing machine oil should be used.

If the suggestions offered here do not correct your sewing problems, call your local Singer Sewing Centre or authorised Singer Dealer.

To all whom it may concern:

The improper placing or renewal of the trademark "**SINGER**" or any other of the trademarks of The Singer Company (all of which are duly Registered Trademarks) on any machine that has been repaired, rebuilt, reconditioned, or altered in any way whatsoever outside a SINGER factory or an authorized SINGER agency is forbidden.

www.Singer-Featherweight.com

For your protection

SINGER Sewing Machines are sold and serviced wherever you see the famous SINGER and Red "S" Trademarks. When your machine needs servicing call your SINGER SEWING CENTRE to be sure of warranted SINGER parts and service. See address in the classified telephone directory.



SINGER SEWING MACHINE COMPANY