

# Herman Series





# Herman Series

The Herman series merges modern aesthetics with functionality. The Herman Chair was originally designed in 2013 by the Danish design duo Herman Studio, and has since 2015 been produced by ferm LIVING.

Since then, a number of products have been born into the Herman family, including a bar chair, stool, lounge chair, as well as laundry and magazine stands. In the series, clean lines and a contemporary aesthetic are met with simple functionality that make for classic pieces that are easy to integrate into any interior space.

## PRODUCT DETAILS

**Product type:** Chair for indoor use

**Sustainability:** FSC™ Mix certified

**Origin:** Latvia

**Design:** In collaboration with Herman Studio



# Herman Dining Chair - Wooden Frame

Design by Herman Studio



## Product details

Manufactured in Latvia  
Registered design

## Dimensions

Height: 74 cm / 29.1 in  
Width: 50 cm / 19.7 in  
Depth: 47 cm / 18.5 in  
Seat height: 45 cm / 17.7 in  
Weight: 4.0 kg (oak/ash veneer)  
4.2 kg (seat only upholstered)  
4.5 kg (fully upholstered)

## Materials and construction

Backrest/seat: Natural oak or painted ash veneer  
Upholstered seat/back: Birch veneer upholstered with fabric or leather  
Frame: Natural solid oak or painted solid ash  
Glides: Plastic or felt glides  
FSC™-Mix certified wood

## Care

Please see [fermliving.com](http://fermliving.com) for care and maintenance instructions

## Packsize

2

## Test

EN 16139:2013

Furniture - Strength, durability, stability and safety  
Requirements for non-domestic seating

## Foam fire rating:

CAL117-2013 - pass  
BS 5852 Crib5: on request

## Stock Versions



1104263815  
Black

1104263538  
Natural Oak

1104263816  
Red Brown

1104263814  
Warm Grey

## Customisation Options

### Frame and backrest options



Black

Natural  
oak

Red  
Brown

### Fabric and leather qualities (seat only)

#### Price group I



Cotton  
Linen

Brushed

#### Price group II



Cyber

Grain

#### Price group III

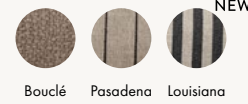

Bouclé

Pasadena

Louisiana

#### Price group IV

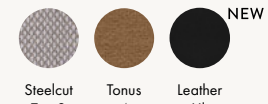

Steelcut  
Trio 3

Tonus  
4

Leather  
- Ultra

#### Price group V

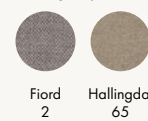

Fiord  
2

Hallingdal  
65

#### Price group VI



Leather  
Envy

To see the specifications of each fabric and available colour assortment please go to the fabric and leather overview. Felt Gliders must be ordered separately against price supplement.

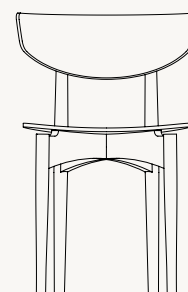

50 cm / 19.7 in

H: 74 cm / 29.1 in

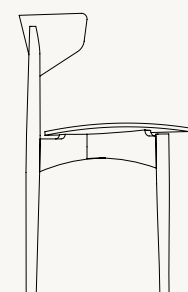

47 cm / 18.5 in

H: 45 cm / 17.7 in

# Herman Dining Chair - Steel Frame

Design by Herman Studio



## Product details

Manufactured in Latvia  
Registered design

## Dimensions

Height: 74 cm / 29.1 in  
Width: 50 cm / 19.7 in  
Depth: 47 cm / 18.5 in  
Seat height: 45 cm / 17.7 in  
Weight: 4.8 kg (oak/ash veneer)  
5 kg (with upholstery)

## Materials and construction

Backrest/seat: White oiled oak, dark stained oak, walnut or painted ash veneer  
Upholstered seat: Birch veneer upholstered with fabric or leather  
Frame: Black powder or chrome coated steel  
Glides: Plastic or felt glides  
FSC™ - Mix certified wood

## Care

Please see [fermliving.com](http://fermliving.com) for care and maintenance instructions

## Packsize

2

## Test

EN 16139:2013

Furniture - Strength, durability, stability and safety  
Requirements for non-domestic seating

## Foam fire rating:

CAL117-2013 - pass  
BS 5852 Crib5: on request

## Stock Versions

### Black frame

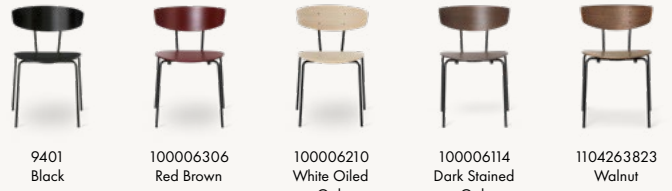

### Chrome frame

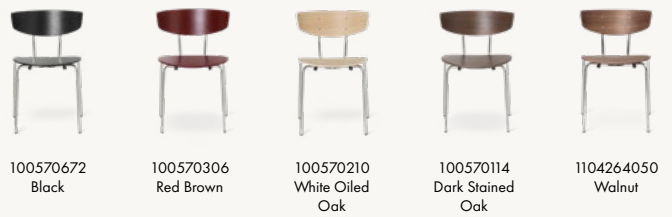

## Customisation Options

### Backrest and seat options

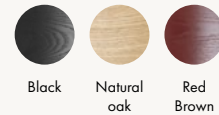

### Frame options



### Fabric and leather qualities (seat only)

#### Price group I



#### Price group II

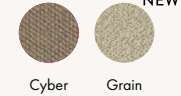

#### Price group III

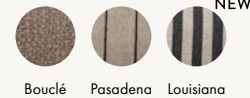

#### Price group IV



#### Price group V

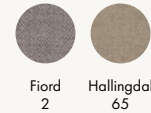

#### Price group VI



To see the specifications of each fabric and available colour assortment please go to the fabric and leather overview. Felt Gliders must be ordered separately against price supplement.

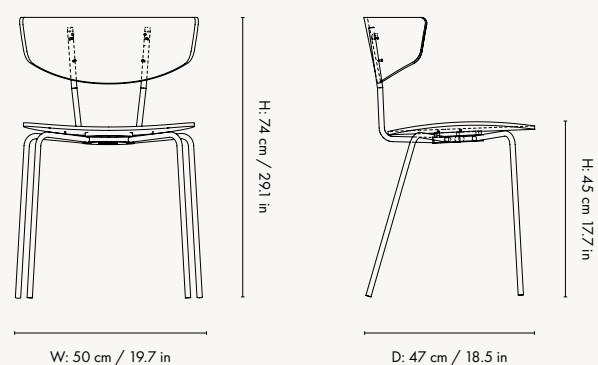

# Herman Stool

Design by Herman Studio



## Product details

Manufactured in Latvia

## Dimensions

Height: 45 cm / 16.9 in  
Width: 35.5 cm / 13.9 in  
Depth: 30.5 cm / 12 in  
Seat height: 45 cm / 17.7 in  
Weight: 2.9 kg (oak/ash veneer)  
3 kg (with upholstery)

## Materials and construction

Seat: White oiled oak, dark stained oak, walnut or painted ash veneer  
Upholstered seat: Birch veneer upholstered with fabric or leather  
Frame: Black powder or chrome coated steel.  
Glides: Plastic or felt glides  
FSC™ - Mix certified wood

## Care

Please see [fermliving.com](http://fermliving.com) for care and maintenance instructions

## Packsize

2

## Test

EN 16139:2013

Furniture - Strength, durability, stability and safety  
Requirements for non-domestic seating

## Foam fire rating:

CAL117-2013 - pass  
BS 5852 Crib5: on request

## Stock Versions

### Black frame



100073101  
Black



100073210  
White Oiled  
Oak

### Chrome frame



100571101  
Black



100571210  
White Oiled  
Oak

## Customisation Options

### Backrest and seat options

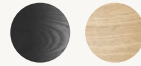

Black Natural oak

### Frame options



Black Chrome

### Fabric and leather qualities (seat only)

#### Price group I



Cotton Linen Brushed

#### Price group II

NEW



Cyber Grain

#### Price group III

NEW

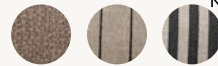

Bouclé Pasadena Louisiana

#### Price group IV

NEW



Steelcut Trio 3 Tonus 4 Leather - Ultra

#### Price group V



Fiord 2 Hallingdal 65

#### Price group VI



Leather Envy

To see the specifications of each fabric and available colour assortment please go to the fabric and leather overview. Felt Gliders must be ordered separately against price supplement.

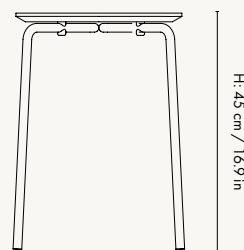

W: 35.5 cm / 13.9 in

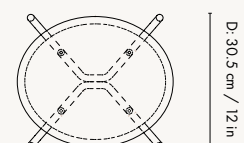

W: 35.5 cm / 13.9 in

# Herman Counter Chair

Design by Herman Studio



## Product details

Manufactured in Latvia  
Registered design

## Dimensions

Height: 87 cm / 34.3 in  
Width: 39.6 cm / 15.5 in  
Depth: 39.4 cm / 15.5 in  
Seat height: 64 cm / 25 in  
Weight: 4.9 kg (ash veneer)  
5.1 kg (with upholstery)

## Materials and construction

Backrest/seat: White oiled oak or painted ash veneer  
Upholstered seat: Birch veneer upholstered with fabric or leather  
Frame: Black powder coated steel  
Glides: Plastic or felt glide  
FSC™ - Mix certified wood

## Care

Please see [fermliving.com](http://fermliving.com) for care and maintenance instructions

## Packsize

1

## Test

EN 16139:2013

Furniture - Strength, durability, stability and safety  
Requirements for non-domestic seating

## Foam fire rating:

CAL117-2013 - pass  
BS 5852 Crib5: on request

## Stock Versions



9420  
Black



1104265494  
White Oiled Oak

## Customisation Options

### Backrest and seat options

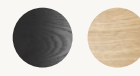

Black Natural oak

### Frame option



Black

### Fabric and leather qualities (seat only)

#### Price group I



Cotton Linen Brushed

#### Price group II



Cyber Grain

NEW

#### Price group III

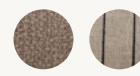

Bouclé Pasadena Louisiana

NEW

#### Price group IV



Steelcut Trio 3 Tonus 4 Leather - Ultra

NEW

#### Price group V



Fiord 2 Hallingdal 65

#### Price group VI



Leather Envy

To see the specifications of each fabric and available colour assortment please go to the fabric and leather overview. Felt Gliders must be ordered separately against price supplement.

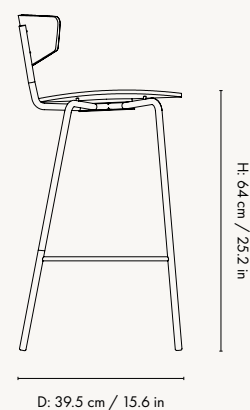
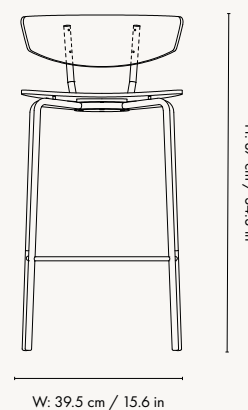

# Herman Bar Chair

Design by Herman Studio



## Product details

Manufactured in Latvia  
Registered design

## Dimensions

Height: 96 cm / 37.8 in  
Width: 40.5 cm / 15.7 in  
Depth: 43 cm / 16.9 in  
Seat height: 76 cm / 29.9 in  
Weight: 5.3 kg (ash veneer)  
5.1 kg (with upholstery)

## Materials and construction

Backrest/seat: White oiled oak or painted ash veneer  
Upholstered seat: Birch veneer upholstered with fabric or leather  
Frame: Black powder coated steel  
Glides: Plastic or felt glide  
FSC™ - Mix certified wood

## Care

Please see [fermliving.com](http://fermliving.com) for care and maintenance instructions

## Packsize

1

## Test

EN 16139:2013

Furniture - Strength, durability, stability and safety  
Requirements for non-domestic seating

## Foam fire rating:

CAL117-2013 - pass

BS 5852 Crib5: on request

## Stock Versions



9421  
Black



1104265495  
White Oiled Oak

## Customisation Options

### Backrest and seat options

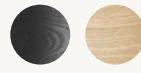

Black Natural oak

### Frame option



Black

### Fabric and leather qualities (seat only)

#### Price group I



Cotton Brushed Linen

#### Price group II



Cyber Grain

NEW

#### Price group III

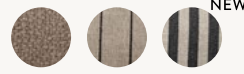

Bouclé Pasadena Louisiana

NEW

#### Price group IV



Steelcut Trio 3 Tonus 4 Leather - Ultra

NEW

#### Price group V



Fiord 2 Hallingdal 65

#### Price group VI



Leather Envy

To see the specifications of each fabric and available colour assortment please go to the fabric and leather overview. Felt Gliders must be ordered separately against price supplement.

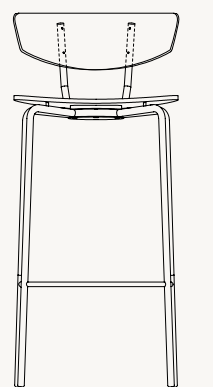

W: 40.5 cm / 15.9 in

H: 95.9 cm / 29.1 in

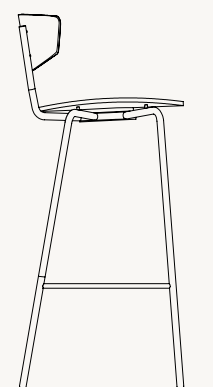

D: 42.8 cm / 16.9 in

H: 76.2 cm / 30 in



# Herman Lounge Chair

Design by Herman Studio



## Product details

Manufactured in Latvia  
Registered design

## Dimensions

Height: 68 cm / 26.8 in  
Width: 68 cm / 26.8 in  
Depth: 60 cm / 23.6 in  
Seat height: 37 cm / 14.6 in  
Weight: 6.9 kg (ash veneer)  
7.3 kg (with upholstery)

## Materials and construction

Backrest/seat: Painted ash veneer  
Upholstered seat: Birch veneer upholstered with fabric or leather  
Frame: Black powder coated steel  
Glides: Plastic or felt glide  
FSC™ - Mix certified wood

## Care

Please see [fermliving.com](http://fermliving.com) for care and maintenance instructions

## Packsize

1

## Test

EN 16139:2013  
Furniture - Strength, durability, stability and safety  
Requirements for non-domestic seating

## Foam fire rating:

CAL117-2013 - pass  
BS 5852 Crib5: on request

## Stock Versions



9404  
Black

## Customisation Options

### Backrest and seat options



Black

### Frame option



Black

### Fabric and leather qualities (seat only)

#### Price group I



Cotton  
Linen      Brushed

#### Price group II



Cyber      Grain

NEW

#### Price group III

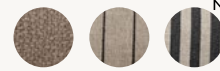

Bouclé      Pasadena      Louisiana

NEW

#### Price group IV



Steelcut  
Trio 3      Tonus  
4      Leather  
- Ultra

NEW

#### Price group V



Fiord  
2      Hallingdal  
65

#### Price group VI



Leather  
Envy

To see the specifications of each fabric and available colour assortment please go to the fabric and leather overview. Felt Gliders must be ordered separately against price supplement.

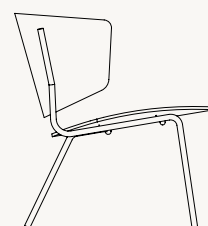

H: 37 cm / 14.6 in

D: 60 cm / 23.6 in

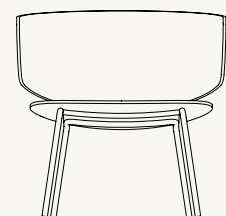

H: 68 cm / 26.8 in

W: 68 cm / 26.8 in

# Herman Louge Chair - Wooden Frame

Design by Herman Studio



## Product details

Manufactured in Latvia  
Registered design

## Dimensions

Height: 71 cm / 28 in  
Width: 72.5 cm / 28.5 in  
Depth: 64.5 cm / 25.4 in  
Seat height: 43 cm / 16.9 in  
Weight: 6.9 kg (ash veneer)  
7.3 kg (with upholstery)

## Materials and construction

Backrest/seat: Birch veneer upholstered with fabric or leather  
Frame: Natural solid oak or painted solid ash  
Glides: Plastic or felt glides  
FSC™ Mix certified wood

## Care

Please see [fermliving.com](http://fermliving.com) for care and maintenance instructions

## Packsize

1

## Test

EN 16139:2013

Furniture - Strength, durability, stability and safety  
Requirements for non-domestic seating

## Foam fire rating:

CAL117-2013 - pass

BS 5852 Crib5: on request

## Stock Versions



1104265573  
Natural Oak



1104265806  
Black

## Customisation Options

### Backrest and seat options

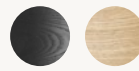

Black Natural oak

### Fabric and leather qualities (seat only or fully upholstered)

#### Price group I



Cotton Linen Brushed

#### Price group II

NEW



Cyber Grain

#### Price group III

NEW

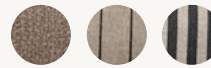

Bouclé Pasadena Louisiana

#### Price group IV

NEW



Steelcut Trio 3 Tonus 4 Leather - Ultra

#### Price group V



Fiord 2 Hallingdal 65

#### Price group VI



Leather Envy

To see the specifications of each fabric and available colour assortment please go to the fabric and leather overview. Felt Gliders must be ordered separately against price supplement.  
For fully upholstered version the seat and backrest must have same fabric and leather qualities.

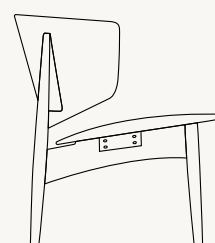

W: 73.5 cm / 28.9 in

H: 43 cm / 16.9 in

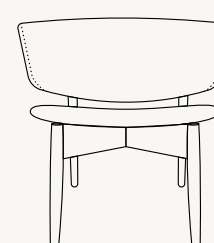

W: 73.5 cm / 28.9 in

H: 71 cm / 28 in

# Fabric and Leather Options

Herman Collection

## Price Group 1

Cotton Linen	•
Brushed	•

## Price Group 2

Faded Velvet	
Rich Velvet	
Hot Madison	
Cyber	•
Grain	•

## Price Group 3

Pasadena	•
Louisiana	•
Focus	
Bouclé	•

## Price Group 4

Leather – Ultra	•
Tonus 4	•
Steelcut Trio 3	•
Confetti Bouclé	
Rich Linen	
Wool Bouclé	

## Price Group 5

Hallingdal 65	•
Fiord 2	•
Patchwork	

## Price Group 6

Leather - Envy	•
----------------	---

See fabric overview for details  
Separate overview available for UK and US

Space to feel comfortably you