

Catena Modular Sofa Collection

Assembly manual

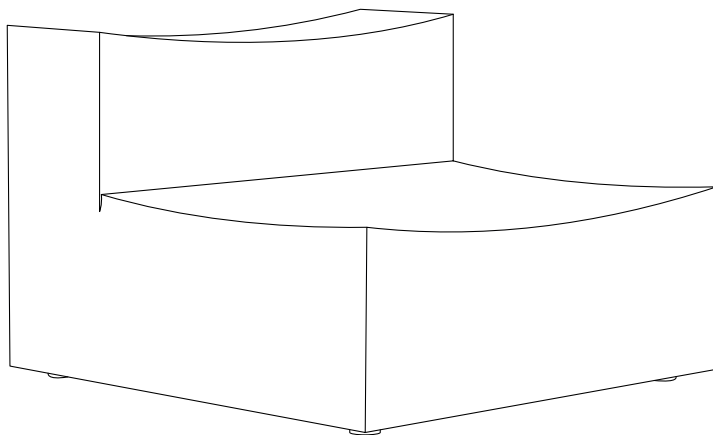

ferm
L I V I N G

General Instructions

PLEASE READ BEFORE INSTALLATION

WARNING:

The safety of this fitting can only be guaranteed if the following instructions are observed during both installation and use. Please retain these instructions safely after installation.

CARE INSTRUCTION:

- Vacuum frequently on medium power. Remove wet stains by carefully dabbing with a lint-free cloth or sponge wrung in warm detergent-free water. For thorough cleaning remove the cover and dry clean. Please note that specific fabric can have different care instructions. To see the specifications of each fabric please go to the fabric overview on our website.

MORE INFORMATION:

To access further information such as product overview and material descriptions, please visit our website at www.fermliving.com. If you have any questions or comments, please do not hesitate to contact us at info@fermliving.com.

Catena Modular Sofa Collection Overview

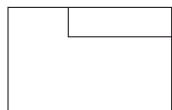

Open End Module - Left
Small300 / Large300

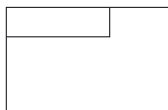

Open End Module - Right
Small301 / Large301

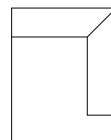

Armrest End Module - Right
Small401 / Large401

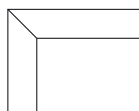

Chaise Longue - Left
Small600 / Large600

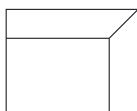

Chaise Longue - Right
Small601 / Large601

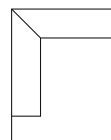

Armrest End Module - Left
Small400 / Large400

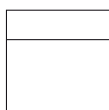

Center Module
Small100 / Large100

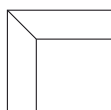

Connecting Corner Module
Small200 / Large200

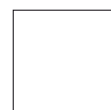

Pouf Square
Small500 / Large500



Pouf Rectangular
Small501 / Large501

Assembly Process – Removing Cover

1

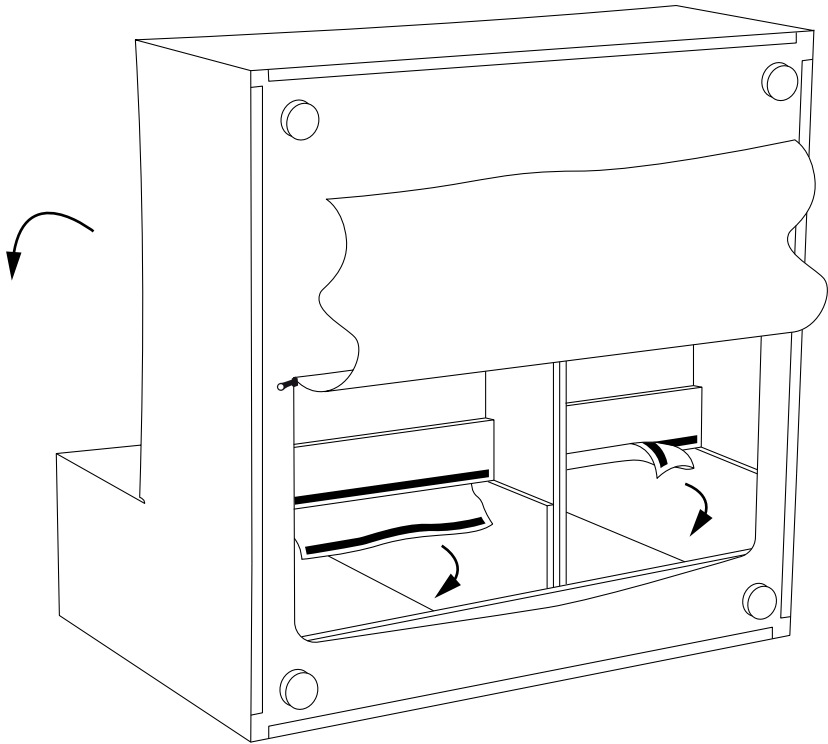

Gently tip the sofa onto its backrest. Unzip the zipper underneath the seat. Locate the two velcro strips on the inside of the structure and undo them to release the black inlay fabric.

Assembly Process – Removing Cover

2

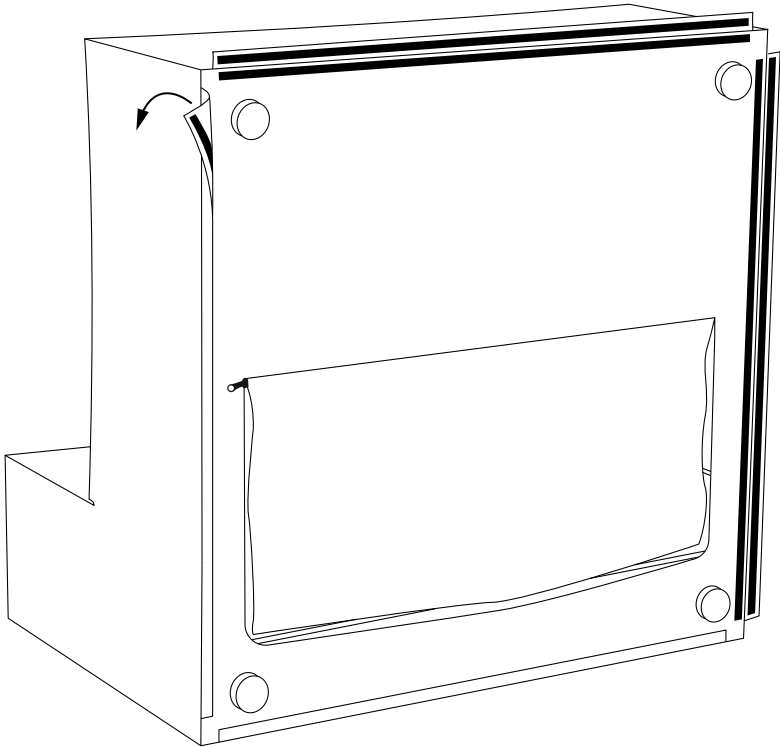

Next, undo the velcro fastenings from all four corners of the seat.

Assembly Process – Removing Cover

3

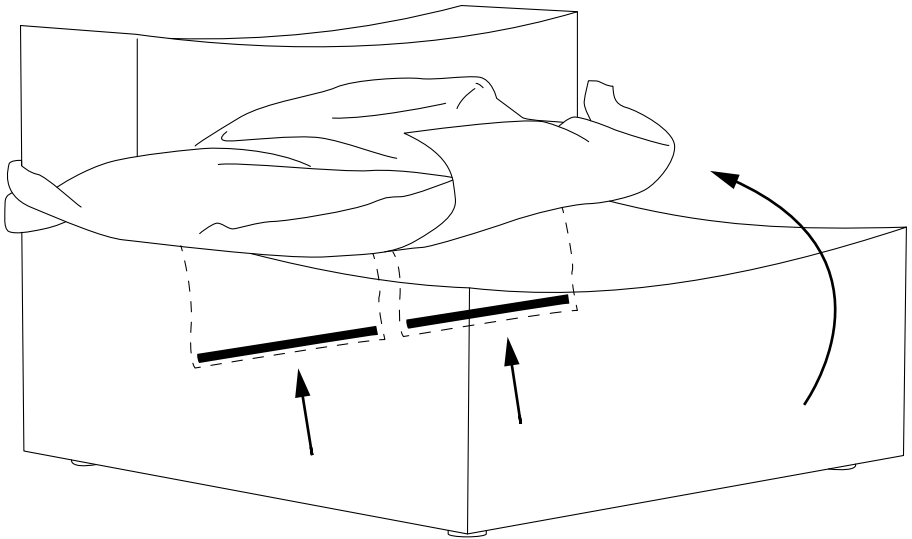

Now, the cover can be carefully removed. Return the sofa to a standing position.
Reach inside the crack where the seat connects with the backrest/armrest and pull the fabric loose.

Assembly Process – Removing Cover

4

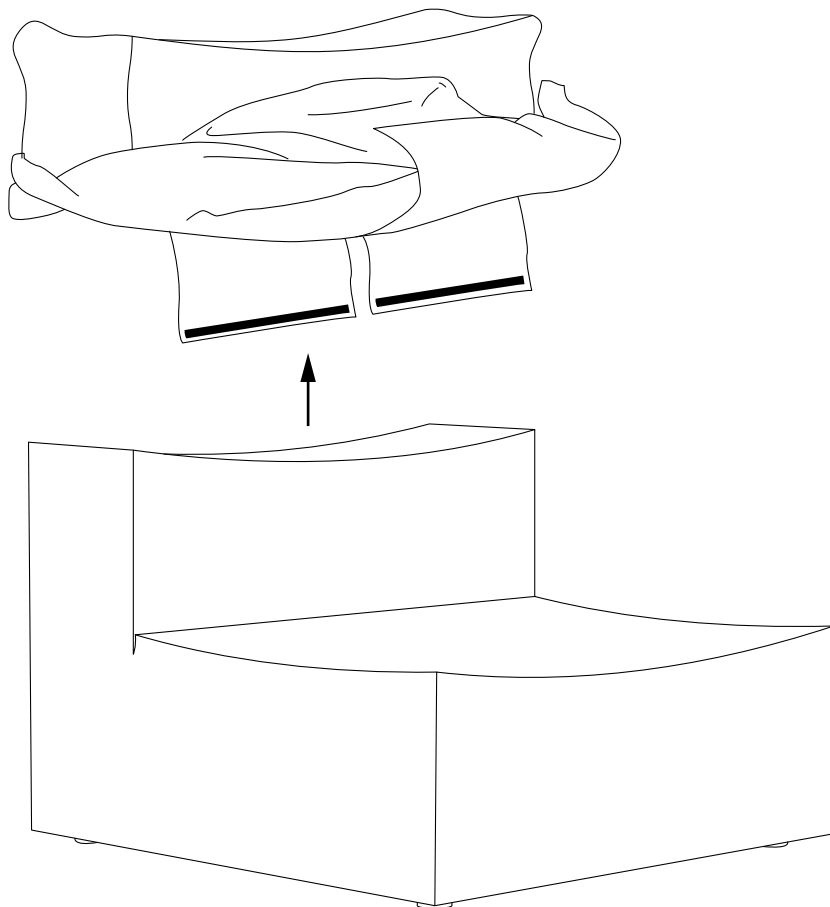

Once the fabric is loose, pull the cover up and off the backrest.

Assembly Process – Putting on Cover

1

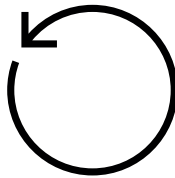

Repeat steps backwards when putting the cover back on.

Note: The cover can be pulled tighter to remove any wrinkles or loose fabric which may form over time.

Attention: When removing and putting on covers, be careful that the connection system does not get in the way and cause damage to the fabric.

fermliving.com