

MS24 REGULAR HOUSING

Military Qualified 2x4 GPS Splitter

DESCRIPTION

The MS24 is a military qualified, two-input, four-output, GPS splitter which includes an antenna health sensor and an embedded antenna switch. Dual input ports allow the splitter to be connected to two GPS receive antennas. The sensor monitors the health of the primary antenna connected to the splitter. Based on the information provided by the sensor, the splitter will switch to the secondary antenna in the event of a failure with the primary antenna.

If the failure in the primary is resolved, the splitter will automatically switch back to the primary. The embedded switch has been designed so it can be controlled externally. This external control can also override the internal automatic switch.

The MS24 can eliminate the need for multiple GPS antennas on the surface of a roof or other platform as four RF output ports allow the MS24 to distribute (split) the signal to multiple devices. Redundancy is acquired through the use of a primary antenna and a backup antenna. The ability of the MS24 to switch antennas allows all connected GPS devices to remain fully functional in the event of an antenna failure. As with all splitters available from GPS Source, passive, amplified, or custom gain can be configured for the device.

FEATURES

- Embedded Antenna Health Sensor
- Automatic Internal Antenna Port Switch
- External Antenna Port Switching Capability
- Passes GPS L1/L2, GLONASS L1/L2, Galileo, Compass
- Optional Antenna Fault Indicator Panel

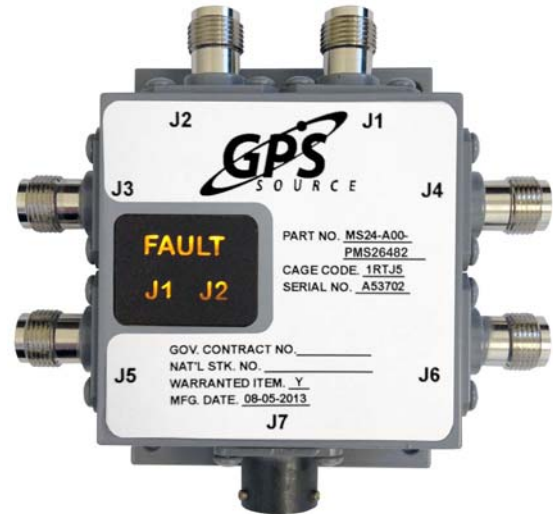

MS24 With Optional LED Fault Indicator Panel

The MS24 is for military applications and environments where high reliability is required. It has been designed to the following MIL standards.

MIL Standards		
MIL-STD-810G	MIL-STD-704	MIL-STD-1587
MIL-STD-1472	MIL-E-5400	MIL-STD-461F
MIL-STD-202	MIL-HDBK-454	MIL-STD-1275D
MIL-STD-883	MIL-DTL-26482	

OPTIONS

The MS24 splitter comes with many available options to meet specific needs. Please contact GPS Source for further information on product options and specifications.

1. MS24 Specifications

1.1 Electrical Specifications

Table 1-1. Operating Temperature -40°C to 85°C

Parameter		Conditions	Min	Typ	Max	Units
Frequency Range		Ant: Any Port; Unused Ports: 50Ω	1		1.7	GHz
Gain	Amplified (Normal)	Ant: Any Port; Unused Ports: 50Ω	6	8	10	dB
	Amplified (Custom)	As Specified (xdB, from 0 to 8dB)	X - 2	X	X + 2	dB
Loss-Passive		Ant: Any Port; Unused Ports: 50Ω	8	9	10	dB
Input SWR		All Ports 50Ω			2:1	—
Output SWR		All Ports 50Ω			2:1	—
Noise Figure-Amplified		Ant: Any Port; Unused Ports: 50Ω, Gain = 8dB			4.3	dB
Gain Flatness	Amplified	[L1 – L2] Ant: Any Port; Unused Ports: 50Ω			2	dB
	Passive				1	dB
Amp. Balance		[J3 – J6] Ant: Any Port; Unused Ports: 50Ω			0.5	dB
Phase Balance		Phase (J3 – J6) Ant: Any Port; Unused Ports: 50Ω			1	Degree
Group Delay Flatness		T _{d,max} - T _{d,min} ; J3 – J1 (Ant) or J3 – J2			1	ns
Isolation	Amp/Pass (Norm) (Gain = 8dB)	Opposite Ports: Ant – 50Ω Adjacent Ports: Ant – 50Ω	20 12			dB
	Amp (Hi Iso.) (Gain = 8dB)	Opposite Ports: Ant – 50Ω Adjacent Ports: Ant – 50Ω	38 28			dB
Output I_{P3} (Amplified)		Ant: Any Port; Unused Ports 50Ω, Gain = 8dB, Tone Spacing = 1MHz	12			dBm
Output P_{1dB} (Amplified)		Ant: Any Port; Unused Ports 50Ω, Gain = 8dB	0			dBm
DC IN	DC Blk	Any DC Blocked Port with a 200Ω Load			12	VDC
	Pass DC ⁽¹⁾ Amplified/Passive	Non-Powered Configuration, DC Input on J3	3.1		12	VDC
	Powered ⁽²⁾	Powered, Mil. Conn.	16	28	32	VDC
Current (I_{internal})		Current consumption of device without fault panel (excludes antenna current)		25	30	mA
Current Draw		Current draw of device with fault panel (excludes antenna current)		85	90	mA
Ant/Thru Current	Pass DC	Non-Powered Configuration, DC Input on J3			250	mA
	Powered ⁽²⁾	Powered, Mil. Conn.			65 ⁽³⁾	mA
Max RF Input	Amplified	Max RF Input Without Damage			20	dBm
	Passive				40	dBm

- Notes: 1. DC output voltage to the antenna port (J1) or (J2) must be specified by customer.
 2. Compliant to MIL-STD-704G or MIL-STD-1275D.
 3. Maximum current sourced by MS24 to power the selected antenna under maximum voltage input of 32V and maximum operating ambient temperature of 85°C.

1.2 Antenna Control Specifications

Antenna control can be automatic with manual override.

Automatic Control (Default Option) — The automatic control will automatically select the primary or alternate antenna based on the fault status of the two antennas. The fault status is determined by the current draw of the antennas. A current draw below 12.5mA and above 120mA will signal a fault at the respective input port. The fault condition will cause the device to automatically switch to the other input port.

External control can override the internal selection of the antenna port (see [Table 1-3](#)).

1.2.1 Antenna Status and Control

The antenna status is available to an external application via a signal conveyed through the power connector (see [Figure 1-1](#), Pin D). The signal enables the external application to identify the antenna selected. By default, the Antenna Status signal will be HIGH if the primary antenna is selected and LOW if the alternate antenna is selected.

The secondary antenna is selected by pulling the antenna's control line to ground through a control such as an open collector/open drain output. The antenna control is available to an external application via a signal conveyed through the power connector (see [Figure 1-1](#), Pin C).

Table 1-2. Antenna Control and Status Specifications

Parameter	Conditions	Min	Typ	Max	Units
Antenna Control	V _{LOW}	0	0.5	1	VDC
	V _{HIGH}	3		12	
Antenna Status	V _{LOW}	0	0.2	0.5	VDC
	V _{HIGH}	3		12	
	I _{SINK}			10	mA

1.2.2 Antenna Power and Ports

The desired antenna voltage is made available at the input ports through either the PMS26482 power connector (*powered* option) or through an RF output port (*non-powered* option). If the non-powered option is chosen, an RF output port (usually J3) is configured as Pass DC. This configuration can pass the DC voltage available from a GPS device and power the receiving antennas, as well as, power the MS24. An RF output port configured as Block DC cannot pass the DC voltage available from a GPS device.

Note: Any DC blocked output port of the MS24 features an internal 200Ω load to simulate an antenna current draw.

In the event of a fault at both the antenna input ports, the internal load opens up and flags the fault condition to the equipment to which it is connected.

Table 1-3. Antenna Power Type and Associated Ports

Power Type	Port	
Powered thru MIL Connector (Standard)	Input ⁽¹⁾	J1, J2 Pass DC
	Output	J3, J4, J5, J6, Block DC with 200Ω load
Powered thru RF Out Coax	Input ⁽¹⁾	J1, J2 Pass DC
	Output	J3 Pass DC, J4, J5, J6, Block DC with 200Ω load

Note: 1. Input ports can be configured as Block DC upon request. If Primary antenna is chosen as Block DC, the external antenna control is required to switch the antennas.

1.2.3 MS24 Power Connector

Figure 1-1. Antenna Power Connector

Pin	Description	MIL-DTL-26482 Type I, Shell Size 10 ⁽¹⁾
A	+28VDC	
B	GND	
C	Antenna Switch Control	
D	Antenna Switch Status	
E	No Contact	
F	No Contact	

Note: 1. Image is not to scale.

1.2.4 Power Connector Mating Option⁽¹⁾

Figure 1-2. Antenna Power Mating Connector

Input	Description	PT06E-10-6S ⁽²⁾
A	+28VDC	
B	GND	
C	Antenna Switch Control	
D	Antenna Switch Status	
E	No Contact	
F	No Contact	

Notes: 1. The power mating connector is not available from GPS Source at this time. Please contact GPS Source for available manufacturing sources.
2. Image is not to scale.

1.3 General Specifications

Table 1-4. General Specifications

Description		Measurement
Weight		0.7lbs (317g)
Mean Time Between Failure (MTBF)	Active Configuration	35,469 at 29°C
		31,739 at 71°C

2. Performance Data

2.1 MS24 — Passive

Figure 2-1. Passive MS24 Splitter: Gain vs. Frequency

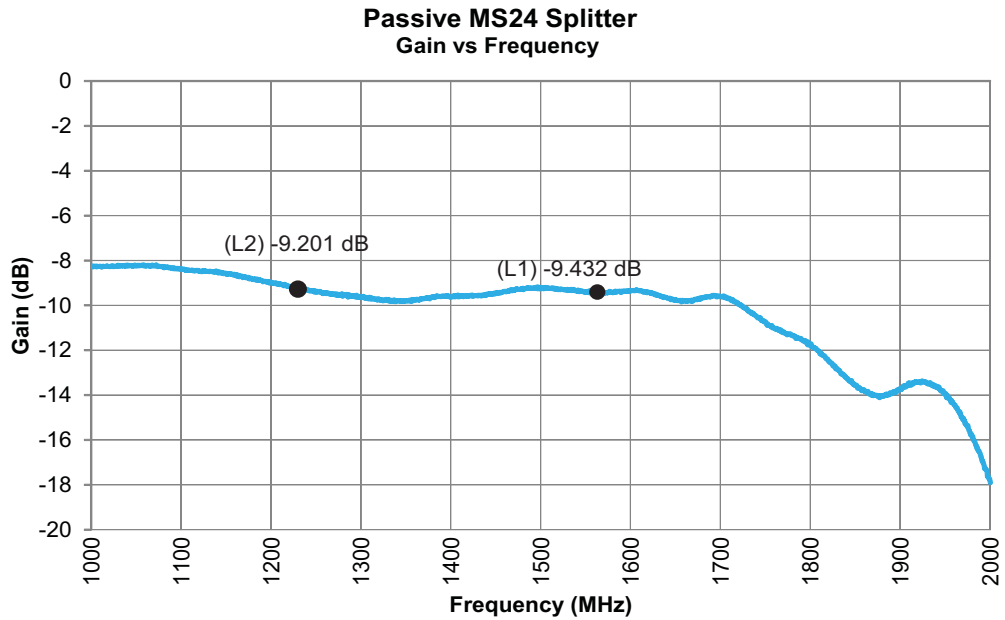
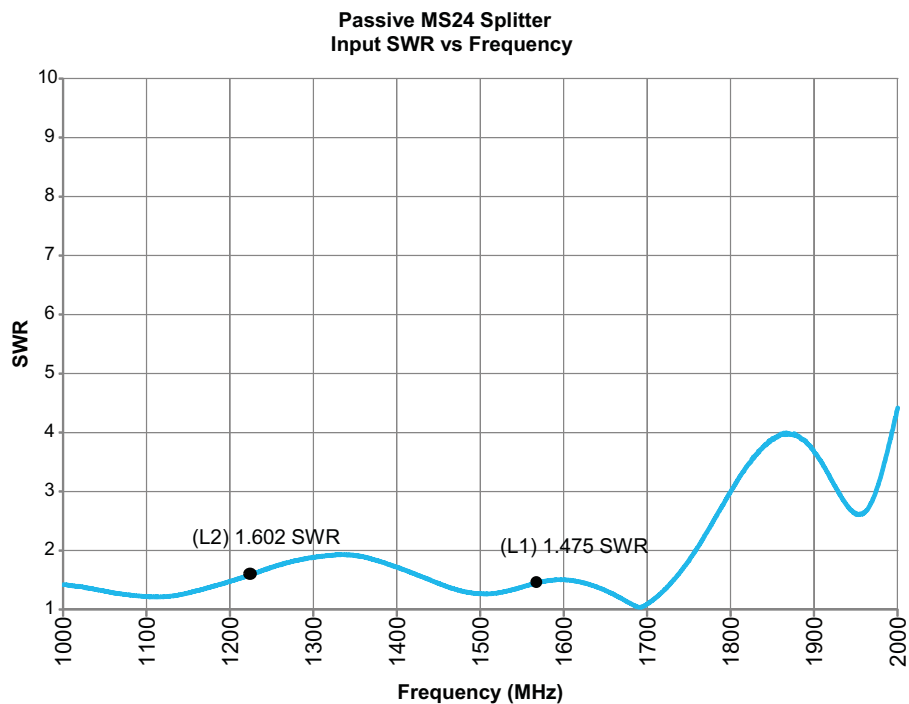

Figure 2-2. Passive MS24 Splitter: Input SWR vs. Frequency



2.2 MS24 — Active

Figure 2-3. Active MS24 Splitter: Gain vs. Frequency

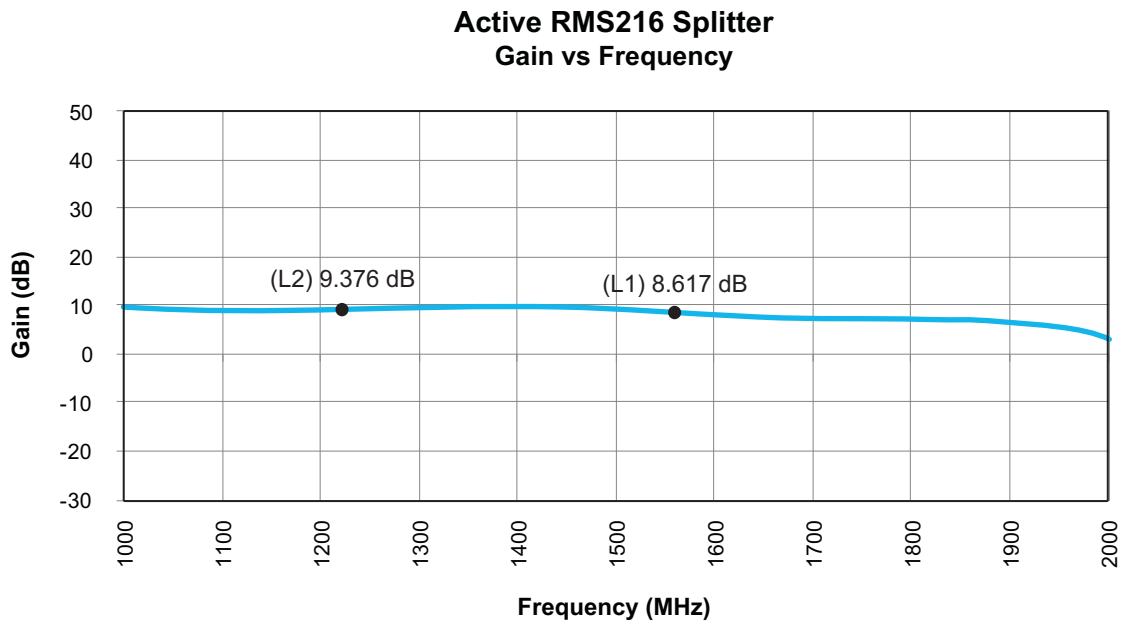
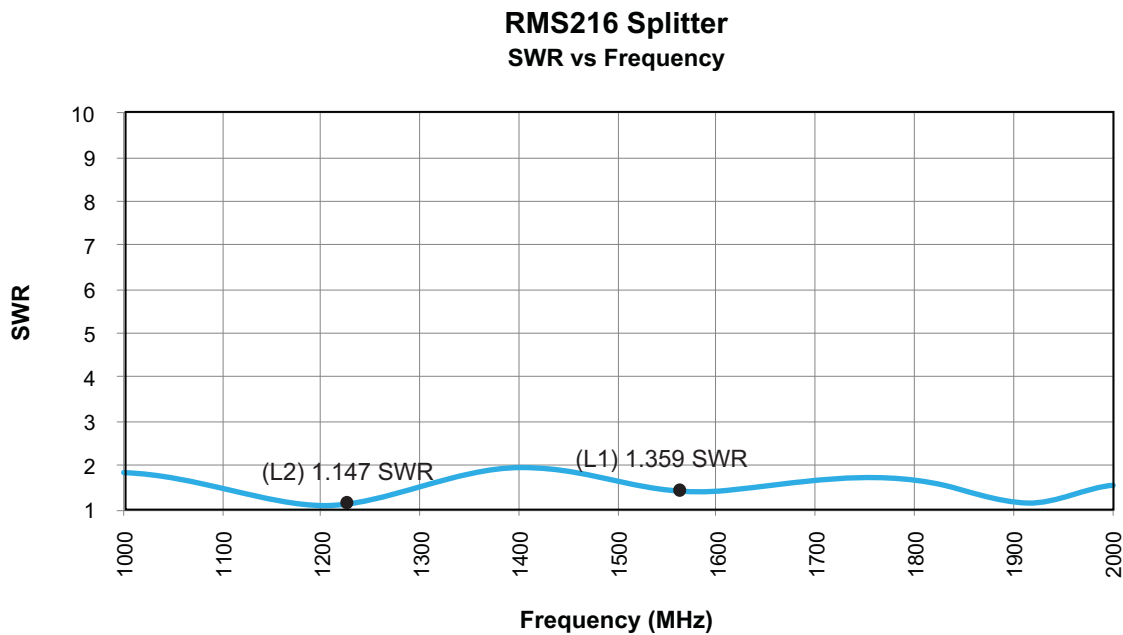

Figure 2-4. Active MS24 Splitter: SWR vs. Frequency



3. Environmental Requirements

3.1 High and Low Temperature

The MS24 has been designed to comply with the temperature-altitude tests per MIL-STD-810G, Methods 501.5, 502.5, Procedure 1 and II.

- **High Temperature** (MIL-STD-810G, Mtd 501.5, Procedure I and II)

The MS24 is designed to operate without degradation in the temperature as defined in MIL-STD-810G, Mtd. 501.5, Procedure I and II for three cycles (24hr cycles over three days), climate category A1 Hot Dry Induced (storage and transit) conditions.

- Steady State High Storage Non-Operation Temperature: +71°C
- Steady State High Operating Temperature: +71°C

- **Low Temperature** (MIL-STD-810G, Mtd 502.5, Procedure I and II)

The MS24 is designed to operate without degradation in the temperature as defined in MIL-STD-810G, Mtd. 502.5, Procedure I and II, Cold (C2), Exposure duration a. (4 hours).

- Steady State Low Storage Non-Operation Temperature: -57°C
- Steady State Low Operating Temperature: -40°C

3.2 Temperature Shock

The MS24 is designed to operate without degradation during temperature shocks as defined in MIL-STD-810G, Mtd. 503.5, Procedure I-C (three cycles).

- T1: -15°C
- T2: +50°C
- Transfer Rate: Modified to 10 minutes.
- Ramp Rate: 6.5°C/min during cycles, <3°C/min to/from ambient.

3.3 Altitude

The MS24 is designed to operate without degradation during exposure to altitude as defined in MIL-STD-810G, Mtd. 500.5, Procedure II.

- Low Altitude: -400m MSL
- High Altitude: +9100m MSL

The MS24 is designed not to cause a material reaction that would endanger nearby personnel or the transportation platform during rapid decompression as defined in MIL-STD-810G, Mtd. 500.5, Procedure III.

- Descents Rate: 100 m/sec. over operational range defined above.

3.4 Explosive Atmosphere

The MS24 is designed for operation in the presence of explosive mixtures of air and jet fuel without causing explosion or fire at atmospheric pressures corresponding to altitudes from -1,800ft to 50,000ft. The MS24 does not produce surface temperatures or heat in excess of 400°F. The MS24 does *not* produce electrical discharges at an energy level sufficient to ignite the explosive mixture when the equipment is turned on or off or operated. The MS24 meets the requirements of MIL-STD-810G, Method 511.5, and Procedure II. The MS24 is designed to be intrinsically safe if possible, which then is exempt from the explosive atmosphere test.

3.5 Salt Fog

The MS24 is designed to meet the requirements of Salt Fog conditions per Paragraph 3.2.24.9 of MIL-E-5400 and MIL-STD-810G Method 509.5. The MS24 is designed to withstand a salt concentration of five percent at a temperature of 35°C for 48 hours without degradation.

3.6 Fungus

The MS24 is designed to meet the requirements MIL-STD-810G, Mtd 508.6, 28 days minimum. If all exposed materials are Group I, the fungus resistance requirement is met by analysis.

3.7 Humidity

The MS24 is designed to withstand a 10 day humidity test conducted per MIL-STD-810G, Method 507.5; Procedure II. Tests consist of cycles with temperatures ranging from 24°C to 41°C and relative humidity ranging from 60% to 100% (non-precipitating) over a period of at least 10 days.

3.8 Sand and Dust

The MS24 is designed to withstand the conditions of method MIL-STD-810G, Mtd 509.5, for a 5% concentration for a minimum of 48 hours.

3.9 Vibration

The MS24 is designed to meet the requirements of random vibration per conditions (MIL-STD-810G, Method 514.6, Procedure I).

3.10 Shock

The MS24 is designed to meet the requirements of MIL-STD-810G Method 516.2 Proc. I and V.

3.11 Flammability

The MS24 is self-extinguishing or nonflammable and is designed to meet the Requirements of Paragraph 5.2.4 of MIL-STD-1587 and Requirement 3 of MIL-HDBK-454.

3.12 Finish and Colors

All case surfaces of the MS24 are treated with chemical film per MIL-DTL-5441, TYPE II, CLASS 3. The MS24 bottom contact surface is free of paint or non-conductive finishes. The MS24 bottom contact surfaces are protected from corrosion by a conductive coating (MIL-DTL-5541). All other surfaces, except connector mating surfaces are primed per MIL-PRF-23377, TYPE 1 CLASS C and painted per MIL-PRF-85285, TYPE 1 COLOR NUMBER (26231), Military Gray (not lusterless variety) per FED-STD-595 (Exceptions: bottom and connector surfaces are free of paint).

3.13 Human Factors

Human Engineering principles and criteria (including considerations for human capabilities and limitations) using MIL-STD-1472 are followed in all phases of design, development, testing, and procedures development. The design is free of all sharp edges, according to MIL-STD-1472.

3.14 Electromagnetic Interference and Compatibility Test

MS24 performs its intended function, and its operation does not degrade the performance of other equipment or subsystems. The MS24 is designed to meet the requirements of MIL-STD-461F:

Table 3-1. Compatibility Test

Test	Description
CE102	Conducted Emissions Power Leads 10kHz to 10MHz
CE106	Conducted Emissions Antenna Terminal 10kHz to 31.5GHz
CS101	Conducted Susceptibility Power Leads 30Hz to 150kHz
CS103	Conducted Susceptibility Antenna Port Intermodulation
CS114	Conducted Susceptibility Bulk Cable Injection 10kHz to 200MHz
RE102	Radiated Emissions Electric Field 10kHz to 18GHz
RS103	Radiated Susceptibility Electric Field 2MHz to 18GHz

3.15 Lightning and Surge

The MS24 is designed to withstand the following lightning electrical transients without permanent damage, system outages, or improper operation lasting beyond the transient period.

The transient is specified as a pin-to-case signal appearing at the equipment interface from a source impedance of 20Ω . Proper operation of the equipment shall be demonstrated with the equipment under test operating into actual or properly simulated interfacing circuits.

The transient is defined as a pin-to-ground (case or chassis) signal of either positive or negative polarity having electrical characteristics as follows:

The transient has a peak amplitude at the equipment connector pins of 800V (or 40A, whichever occurs first) from a source impedance of 20Ω . The transient, when feeding an open circuit load, is defined by the following equation.

The following are derived from the equation:

- $V_p = 800V$
- Time to first peak = 0.16psec
- Time for V_0 to decay to $1/e = 5psec$
- Damped wave basic frequency = 1MHz
- dv/dt average for the rise to the first peak (V_p) = $5KV/\mu sec$
- Maximum energy to a matched load = 10mJ

The waveshape is shown below.

Figure 3-1. Lightning Immunity Test Waveform

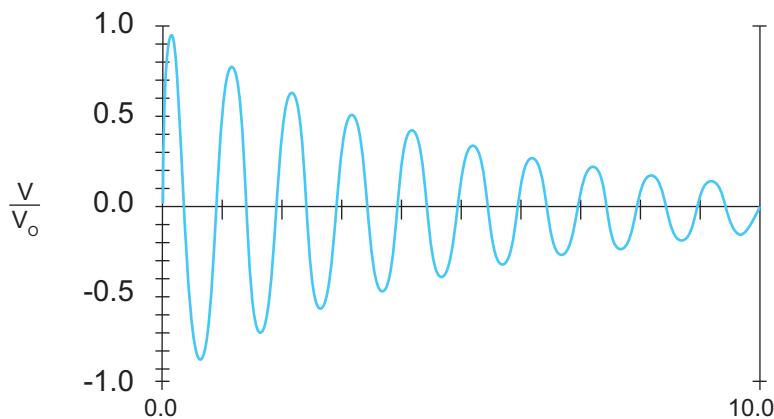

3.16 Electrical Power Service Conditions

The MS24 is able to accommodate the +28VDC vehicle power according to MIL-STD-704F and MIL-STD-1275D. It performs as intended when supplied with the normal, emergency, and starting operation types of electrical power defined by MIL-STD-704F.

The MS24 is designed to meet the following test requirements of MIL-STD-704F:

Table 3-2. MIL-STD-704F Test Requirements

Paragraph	Description
MIL-STD-704F, 5.3.2	DC Full Performance Characteristics, 28VDC system.
MIL-STD-704F, 5.3.2.1	Normal Operation.
MIL-STD-704F, 5.3.2.3 and 5.3.2.4	DC Steady State Voltage in the Emergency or Starting Operation.

The MS24 is designed to meet the following test requirements of MIL-STD-1275D.

Table 3-3. MIL-STD-1275D Test Requirements

Paragraph	Description
MIL-STD-1275D, 5.1.3.1, 5.1.3.2, 5.1.3.3	Normal operating mode, steady-state voltage.
MIL-STD-1275D, 5.1.3.4	Normal Operating mode Spike.
MIL-STD-1275D, 5.1.4.1	Generator-only Operating Mode, steady-state voltage, and ripple conditions.
MIL-STD-1275D, 5.1.4.3, 5.1.4.4	Generator-only Operating Mode surge and spike conditions.

4. Product Options

Table 4-1. MS24 Available Options

Power Supply		
Source Voltage Options	Voltage Input	Type
	DC 16-32VDC	Military Style Connector
Output Voltage	DC Voltage Out	
	3.3	
	5.0	
	12.0	
RF Connector		
Connector	Connector Type	
	N (Female/Male)	N/A
	SMA (Female/Male)	N/A
	TNC (Female/Male)	N/A
Housing		
Housings	Housing Type	Limitations
	Standard	None
Display		
Fault Indicator	Front panel displays faults at J1 and J2 ports.	

5. Product Code Decoder

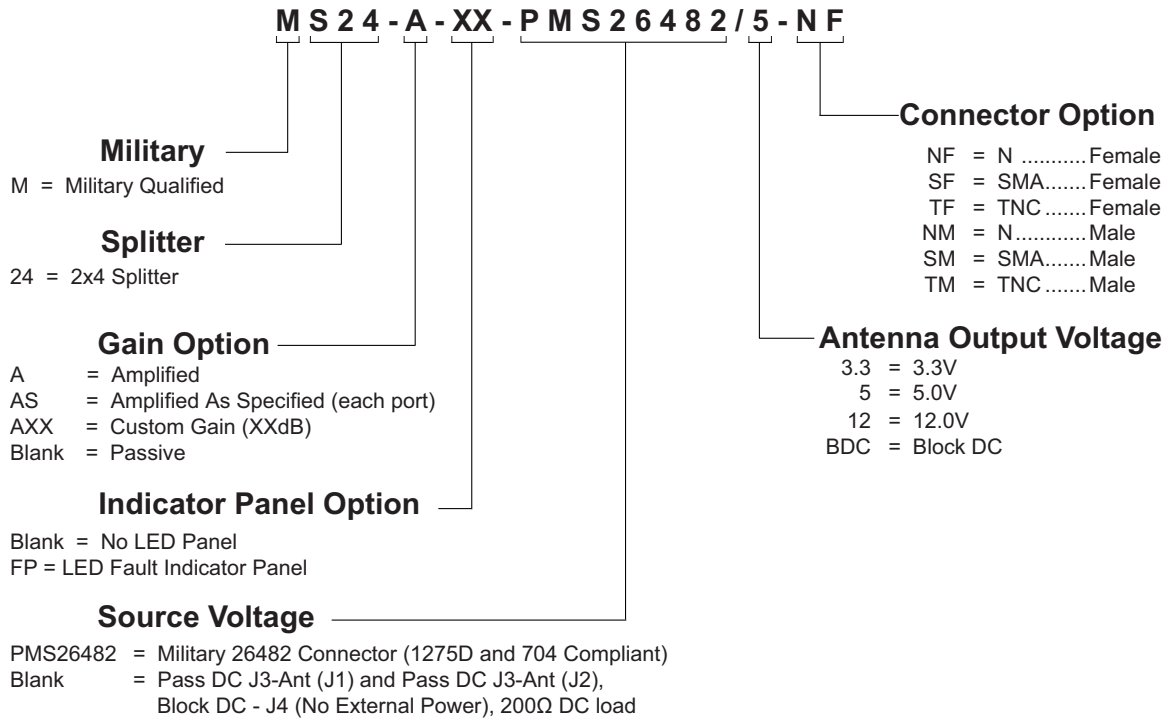

Note: To have product/part codes customized to meet exact needs, contact GPS Source at GPSS-Sales@gd-ms.com or visit the website at www.gpssource.com.

6. Mechanical Drawing

MS24 Regular Housing — FSA-AJQ-AAX-KBZ

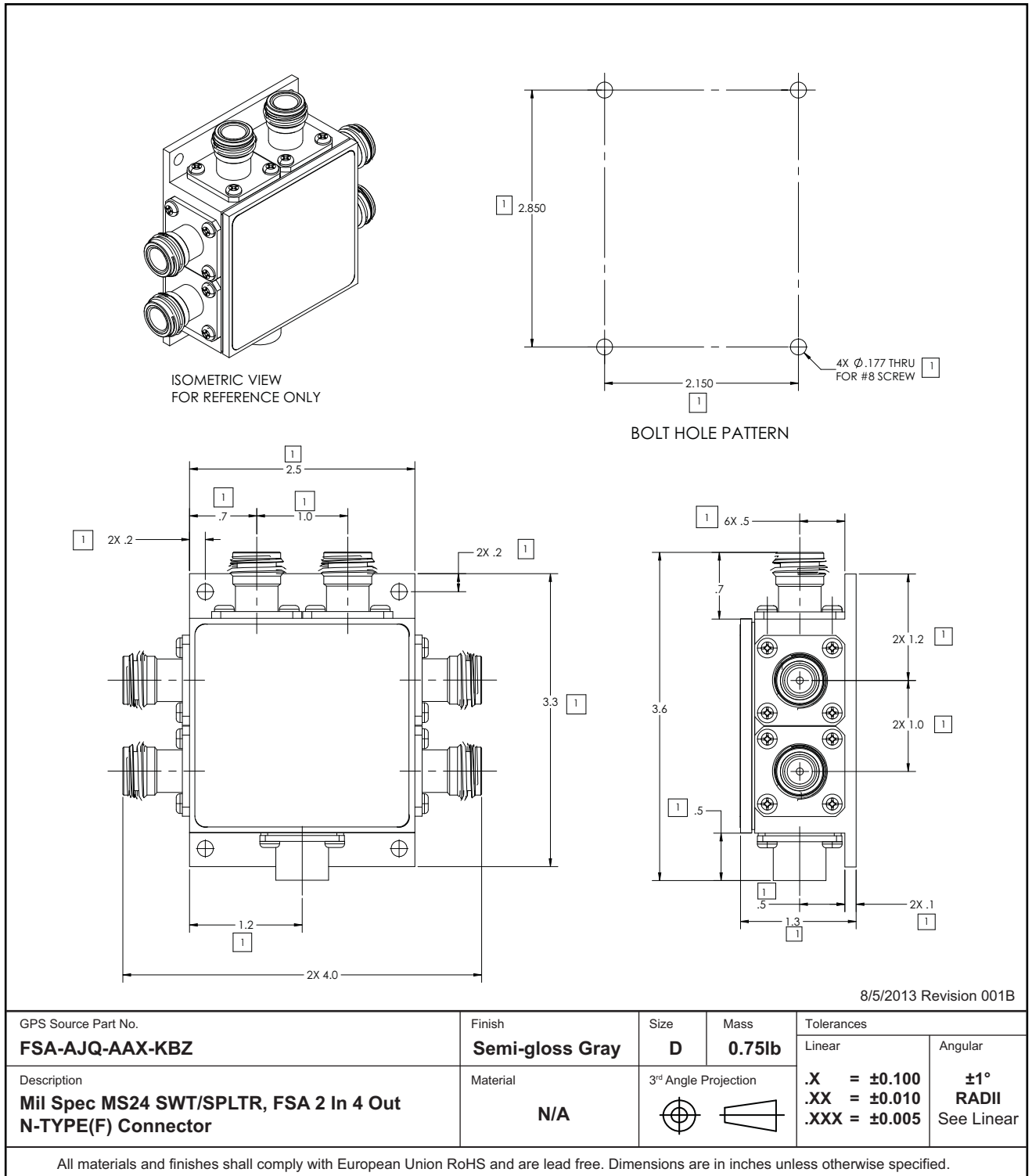

MS24 Regular Housing Data Sheet

059-FSA-AJQ-AAX-KBZ-007

Page 15 of 15, 08/29/2019



2121 Executive Circle, Ste 100
Colorado Springs, CO 80906 USA
Phone: (+1)(719) 421.7300
Toll Free: (+1)(866) 289.4777
GPSS-Sales@gd-ms.com
www.gpssource.com

AS9100 and ISO 9001 Compliant Company



© 2013 GPS Source, Inc. All rights reserved.

GPS Source, Inc., GPS Live Inside, GPS Source logo, and other GPS Source, Inc. products, brands, and trademarks mentioned in this document are property of GPS Source, Inc. and/or its affiliates in the United States and/or other countries. Other products, brands, and trademarks are property of their respective owners/companies. Any rights not expressly granted herein are reserved.

DISCLAIMER: The materials in this document could include inaccuracies or typographical errors and are subject to change at any time. The materials are provided "as is" without warranty of any kind. To the maximum extent permitted by applicable law, GPS Source, Inc. and its suppliers hereby disclaim all warranties, either expressed or implied, and conditions with respect to the materials, their quality, performance, suitability, merchantability, fitness for a particular purpose, title, and non-infringement. LIMITATION OF LIABILITY: IN NO EVENT WILL GPS SOURCE, INC. AND ITS SUPPLIERS BE LIABLE FOR INDIRECT, SPECIAL, INCIDENTAL, OR CONSEQUENTIAL DAMAGES, WHETHER IN AN ACTION OF CONTRACT OR TORT, ARISING OUT OF THE USE OR INABILITY TO USE THE MATERIALS AVAILABLE IN THIS DOCUMENT, EVEN IF ADVISED OF THE POSSIBILITY OF SUCH DAMAGES. IN PARTICULAR AND WITHOUT LIMITATION, GPS SOURCE, INC. SHALL HAVE NO LIABILITY FOR ANY LOSS OF USE, DATA, INCLUDING THE COSTS OF RECOVERING SUCH DATA, OR PROFITS.