

MS12 REGULAR HOUSING

Military Qualified 1x2 GPS Splitter

DESCRIPTION

The MS12 is a military qualified, one-input two-output GPS splitter. Typically applications is where an input from an active GPS roof antenna is split evenly between two receiving GPS units. The MS12 can be configured to pass DC from an RF output (J2) to the antenna input port in order to power an active GPS antenna on that port. The remaining RF output would feature a 200Ω DC load to simulate an antenna DC current draw for any receiver connected to that port. Alternatively, the MS12 can be configured with a MIL-STD-704 or MIL-STD-1275E compliant 28VDC Power Supply that will power the active GPS antenna connected to J1.

FEATURES

- Designed and Manufactured to Military Specifications
- Passes GPS (including M Code), Galileo, GLONASS L1/L2
- Excellent Gain Flatness (Gain |L1 - L2| < 2dB)
- Amplified and Passive Options

The MS12 is for military applications and environments where high reliability is required. It has been designed to the following MIL standards.

MIL Standards	
MIL-STD-810	MIL-E-5400
MIL-STD-1472	MIL-HDBK-454
MIL-STD-202	MIL-STD-1587
MIL-STD-883	MIL-STD-461F
MIL-STD-704	MIL-STD-1275E

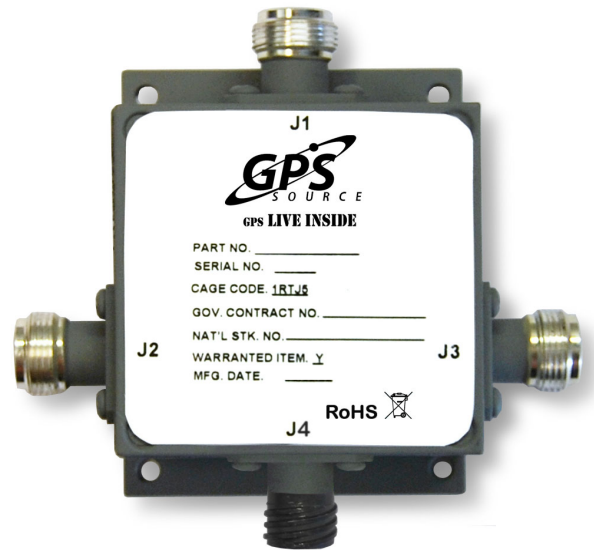

OPTIONS

The MS12 splitter comes with many available options to meet specific needs. Please contact GPS Source via phone, email, or visit the website for further information on product options and specifications.

MS12 Regular Housing Data Sheet

1. MS12 Specifications

1.1 Electrical Specifications

Table 1-1. Electrical Specifications

Operating Temperature -40°C to 85°C

Parameter			Conditions	Min	Typ	Max	Units
Frequency Range			Ant: Any Port; Unused Ports: 50Ω	1		1.7	GHz
Gain	Standard	Amplified	Ant: Any Port; Unused Ports: 50Ω	14	15	16	dB
	Custom	Amplified	As Specified (xdB, from 0 to 15dB)	X - 1	X	X + 1	
Loss-Passive			Ant: Any Port; Unused Ports: 50Ω	3.5	4	5	dB
Input SWR			All Ports 50Ω			2.0:1	—
Output SWR			All Ports 50Ω			2.0:1	—
Noise Figure	15dB Gain	Amplified	Ant: Any Port; Unused Ports: 50Ω			3	dB
Gain Flatness		Amplified	[L1 – L2] Ant: Any Port; Unused Ports: 50Ω			2	dB
		Passive				1	
Amp. Balance			[J2 – J3] Ant: Any Port; Unused Ports: 50Ω			0.5	dB
Phase Balance			Phase (J2 – J3) Ant: Any Port; Unused Ports: 50Ω			1.0	Degree
Group Delay Flatness			$T_{d,max} - T_{d,min}$; J2 – J1 (Ant)			1	ns
Isolation	Normal 15dB Gain	Amp/Pass	Opposite Ports: Ant – 50Ω	16			dB
	High 8dB Gain	Amplified	Opposite Ports: Ant – 50Ω	27			
Input I_{P3}	Amplified		Ant: Any Port; Unused Ports 50Ω 1MHz Tone Spacing		6		dBm
Input P_{1dB}	Amplified		Ant: Any Port; Unused Ports 50Ω		-7		dBm
Current ($I_{internal}$)			Current Consumption of device (excludes Draw)		45	50	mA
Draw Current	Pass DC		Non-Powered Configuration, DC Input on J2			250	mA
	Powered		Powered, Military or Quick Connect Option			75	
Max RF Input		Amplified	Max RF Input Without Damage			20	dBm
		Passive				40	

Table 1-2. DC IN and OUT Specifications

Operating Temperature -40°C to 85°C

Parameter		Condition	Min	Typ	Max	Units	
DC IN	DC Block	Any DC Blocked Port with a 200Ω Load			14	VDC	
	Pass DC	Amplified	Non-Powered Configuration, DC Input on J2	5	7.5		
		Passive		3.3	16		
Powered	Military Connector MIL-STD-704 Normal and Emergency Conditions		16	28	32 ⁽¹⁾		
DC OUT ⁽²⁾	Powered	Amplified	Military Connection; Ant thru Current 75mA		5	7.5	VDC

- Notes: 1. The 1275E spike and surge protection assumes a 28V system, 33.3V, or greater which will trigger over the voltage protection circuitry.
 2. DC output voltage to the antenna port (J1) can be customized to 5V or 7.5V (5V default).

1.1.1 Power Military Connectors PMS-1275/XX and PMS-704/XX Option

Figure 1-1.

Pin	Description	PMS-1275/XX and PMS-704/XX Options ⁽¹⁾
A	Positive	
B	Ground	

Note: 1. Image is not to scale.

1.1.2 Power Military Connector MS38999-1275/XX and PMS38999-704/XX Option

Figure 1-2.

Input	Description	PMS38999-1275/XX and PMS38999-704/XX Options ⁽¹⁾
A	Positive	
B	Ground	
C	No Connect	

Note: 1. Image is not to scale.

1.2 General Specifications

Table 1-3.

Description		Measurement
Weight		0.624lbs (283g)
Mean Time Between Failure (MTBF) ⁽¹⁾	Passive Configuration	305,470 at 29°C
		150,933 at 71°C
	Active Configuration	268,404 at 29°C
		123,019 at 71°C

Note: 1. Calculation derived using Airborne Inhabited Cargo parameters per MIL-STD-217F

2. Performance Data

2.1 MS12 — Passive

Figure 2-1. Passive MS12 Splitter: Gain vs. Frequency

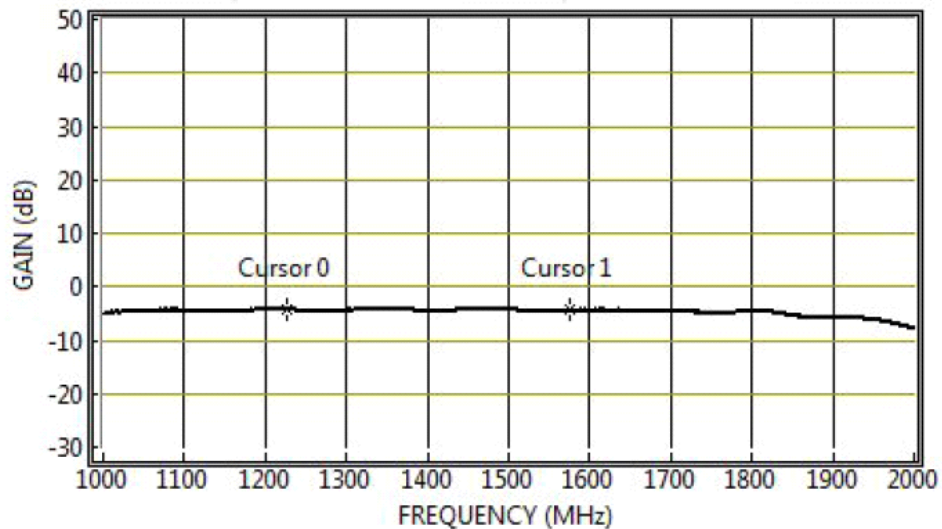
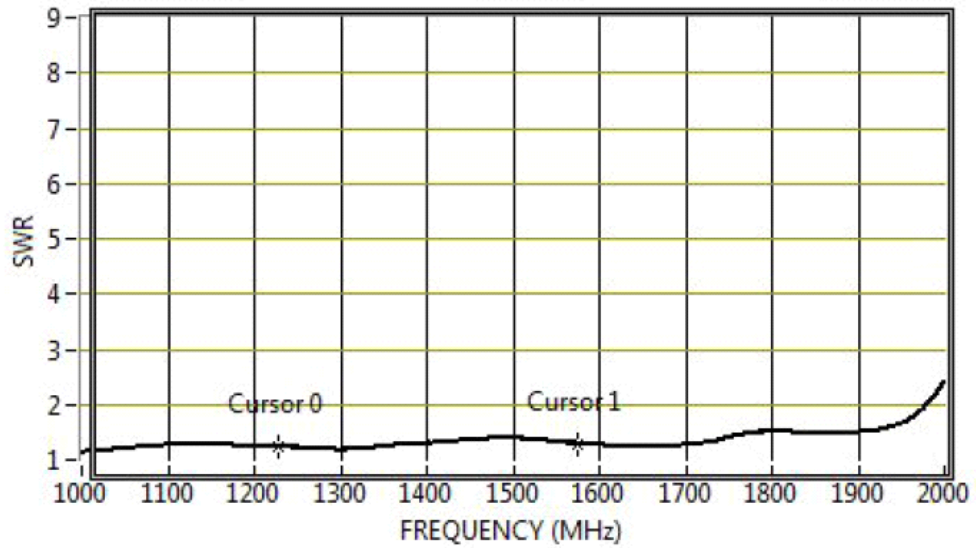

Figure 2-2. Passive MS12 Splitter: SWR vs. Frequency



2.2 MS12 — Active

Figure 2-3. Active MS12 Splitter: Gain vs. Frequency

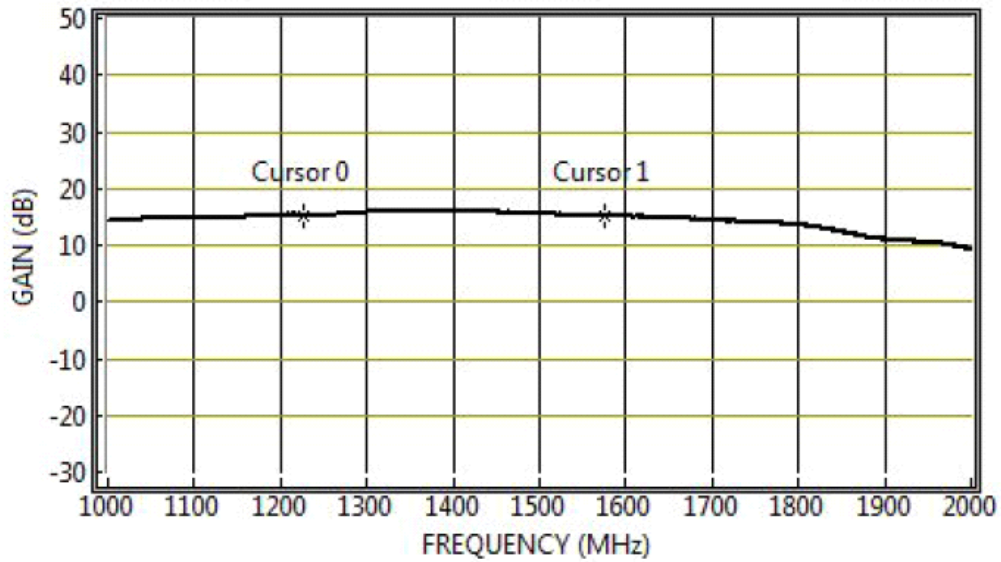
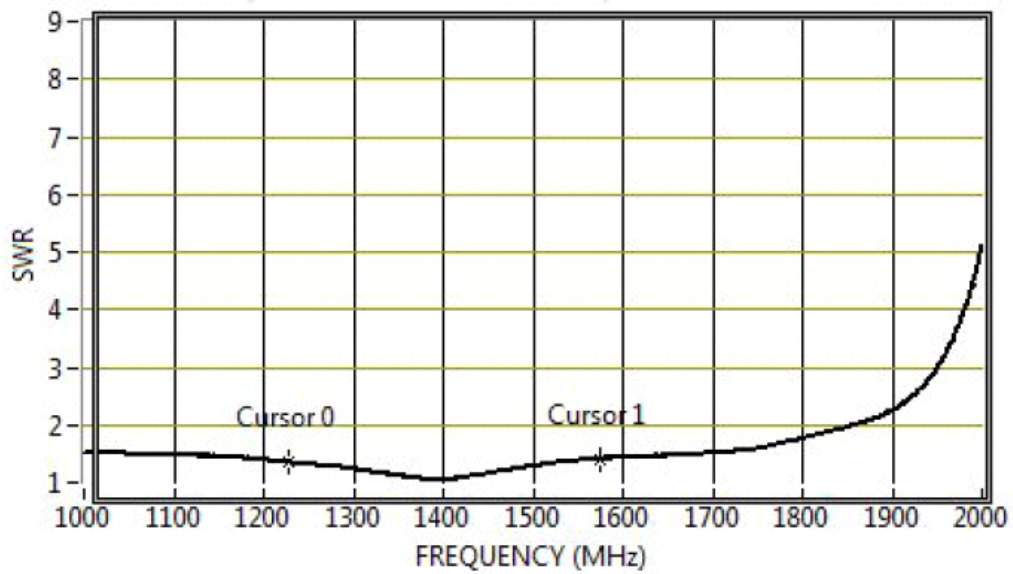

Figure 2-4. Active MS12 Splitter: SWR vs. Frequency



3. Environmental Requirements

3.1 Temperature and Altitude

The MS12 complies with the temperature-altitude tests per MIL-STD-810C, Method 504, Procedure 1 Equipment Category 5.

3.2 Temperature Shock

The MS12 is designed to withstand without degradation (while not operating) Method 503.1, Procedure I of MIL-STD-810C.

3.3 Explosive Atmosphere

The MS12 is designed for operation in the presence of explosive mixtures of air and jet fuel without causing explosion or fire at atmospheric pressures corresponding to altitudes from -1,800ft to 50,000ft. The MS12 does not produce surface temperatures or heat in excess of 400°F. The MS12 does *not* produce electrical discharges at an energy level sufficient to ignite the explosive mixture when the equipment is turned on or off or operated. The MS12 meets the requirements of MIL-STD-810C, Method 511.1, and Procedure II. Hermetically sealed equipment meeting the Requirements of MIL-STD-202, Method 112D, or MIL-STD-883, Method 1014.7 (as applicable), and not exceeding a Helium leakage rate of 1×10^{-7} cc/s are exempt from this requirement.

3.4 Decompression

The MS12 is designed to meet the performance standards per RTCA-DO-160E para 4.6.2 cat D during and following a rapid and complete loss of normal cabin compartment pressurization (10,000 feet) from an airplane flight altitude of 50,000 feet within 15 seconds. The MS12 will remain operating for five minutes at 50,000 feet before being returned to normal cabin pressure.

3.5 Overpressure

MS12 is capable of withstanding for 10 minutes while not operating. A 12.1 PSI compartment pressure with no physical distortion or permanent set RTCA-DO-160E PARA 4.6.3. The MS12 will operate satisfactorily upon return to normal pressure.

3.6 Salt Fog

The MS12 is designed to meet the requirements of Salt Fog conditions per Paragraph 3.2.24.9 of MIL-E-5400 and MIL-STD-810C Method 509.1. The MS12 is designed to withstand a salt concentration of five percent at a temperature of 35°C for 48 hours without degradation.

3.7 Fungus

The MS12 is designed to meet the requirements of Fungus conditions per Paragraph 3.2.24.8 of MIL-E-5400 i.e. fungus inert materials per requirement 4 of MIL-HDBK-454.

3.8 Humidity

The MS12 is capable of meeting the requirements of a ten-day humidity test conducted per MIL-STD-810C, Method 507.1; Procedure I. MS12 is designed to withstand exposure to 95% relative humidity at a temperature of 30°C for 28 days.

3.9 Sand and Dust

The MS12 is capable of meeting the requirements of Sand and Dust conditions of method 510 of MIL-STD-810C, for a temperature of 145°F for a duration of 22 hours.

3.10 Flammability

The MS12 is self-extinguishing or nonflammable and is designed to meet the Requirements of Paragraph 5.2.4 of MIL-STD-1587 and Requirement 3 of MIL-HDBK-454.

3.11 Finish and Colors

All case surfaces of the MS12 are treated with chemical film per MIL-DTL-5441, TYPE II, CLASS 3. The MS12 bottom contact surface is free of paint or non-conductive finishes. The MS12 bottom contact surfaces are protected from corrosion by a conductive coating (MIL-DTL-5541). All other surfaces, except connector mating surfaces are primed per MIL-PRF-23377, TYPE 1 CLASS C and painted per MIL-PRF-85285, TYPE 1 COLOR NUMBER (26231), Military Gray (not lusterless variety) per FED-STD-595 (Exceptions: bottom and connector surfaces are free of paint).

3.12 Human Factors

Human Engineering principles and criteria (including considerations for human capabilities and limitations) using MIL-STD-1472 in all phases of design, development, testing, and procedures development. The design is free of all sharp edges, according to MIL-STD-1472.

3.13 Electromagnetic Interference and Compatibility Test

MS12 performs its intended function and operation does not degrade the performance of other equipment or subsystems. The following table defines the test requirements and test procedures for conducting the required electromagnetic compatibility testing. The MS12 is designed and tested to meet the requirements of MIL-STD-461E:

Table 3-1. Test Requirements & Procedures

Test	Description	
CE102	Conducted Emissions Power Leads	10kHz to 10MHz
CE106	Conducted Emissions Antenna Terminal	10kHz to 31.5GHz
CS101	Conducted Susceptibility Power Leads	30Hz to 150kHz
CS103	Conducted Susceptibility Antenna Port	Intermodulation
CS105	Conducted Susceptibility Antenna Port	Cross-Modulation
CS114	Conducted Susceptibility Bulk Cable Injection	10kHz to 200MHz
RE102	Radiated Emissions Electric Field	10kHz to 18GHz
RS103	Radiated Susceptibility Electric Field	2MHz to 18GHz
Indirect Lightning ⁽¹⁾	Damped Sinusoidal transients,	RF Leads, 10kHz to 100MHz
		Power Leads, 10kHz to 100MHz

Note: 1. For additional detail regarding Indirect Lightning, please contact GPS Source.

3.14 Shock

The MS12 is designed to withstand the shock levels specified in the saw tooth shock pulse parameter specified in Figure 3-1 and Table 3-2. It is designed to meet the requirements of MIL-STD-810C Method 516.2 Proc. III.

Figure 3-1. Peak Shock Levels

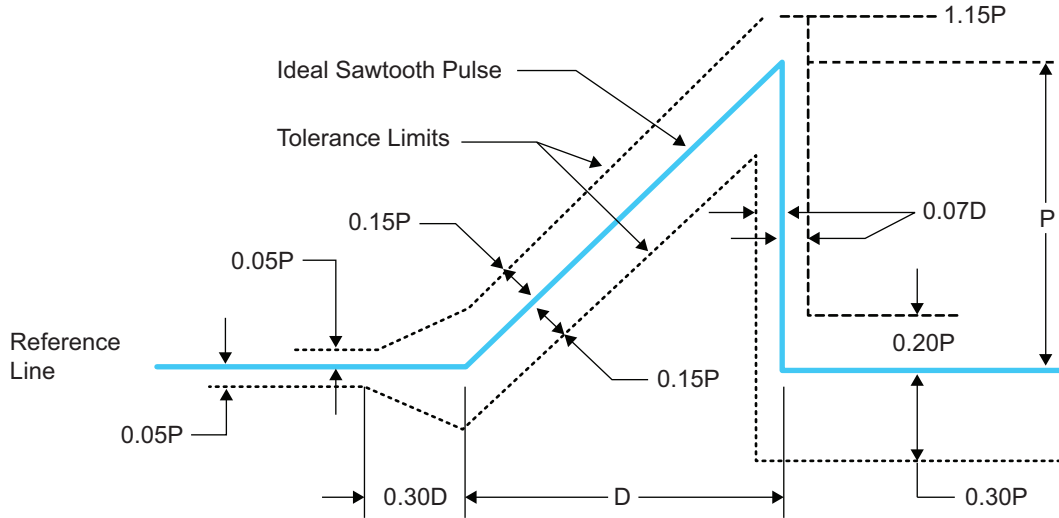

Table 3-2. Peak Shock Levels

Test	Flight Vehicle Equipment	
	Minimum Peak Value (P) g's	Nominal Duration (D) ms
Functional	20	11
Crash Safety	40	11

3.15 Vibration

The MS12 is designed to meet the requirements of random vibration per conditions (MIL-STD-810C, Method 514.2, Procedure 1A) to the levels defined below. Acceleration Power Spectral Density (PSD) for the random vibration envelope is shown in Figure 3-2. Amplitudes for the functional levels and endurance level requirements are as shown in Table 3-3.

Figure 3-2. Zone 3 and 4 Broadband Random Vibration

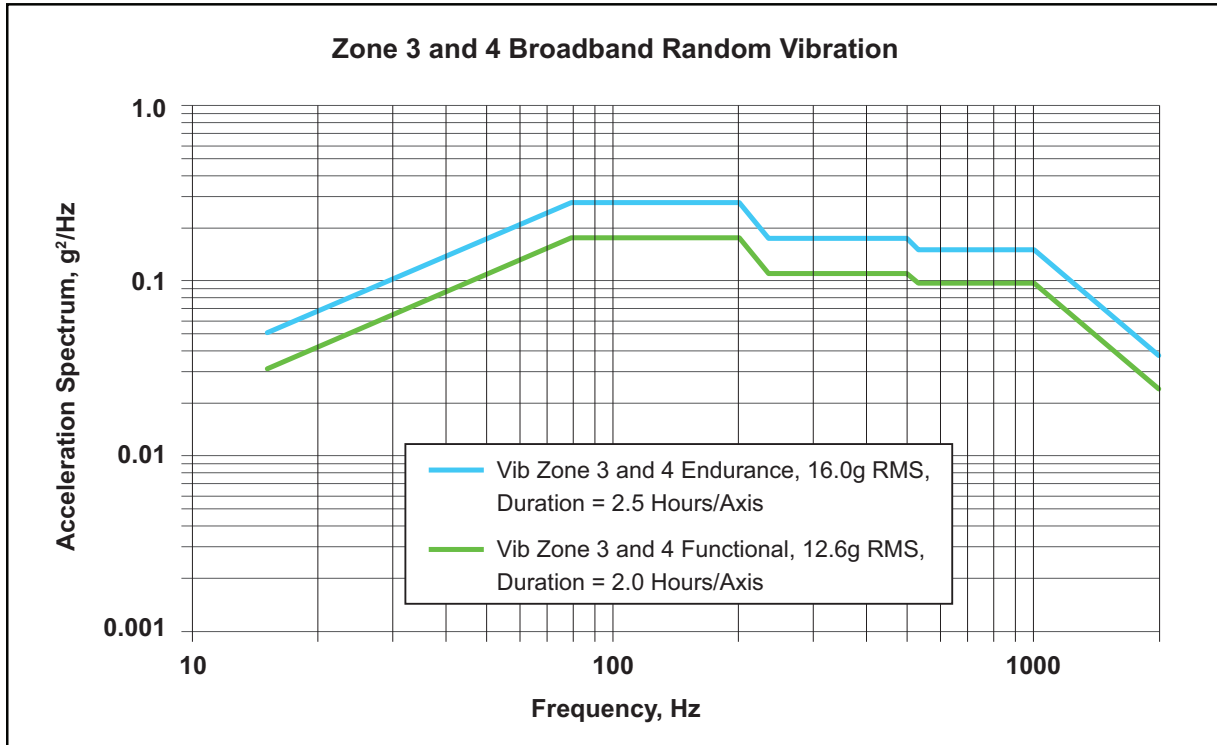

Table 3-3. Vibration Zone 3 and 4

Vibration Zone 3 and 4 Functional, 12.6g RMS Duration = 2 Hours/Axis	
Freq. Hz	g ² /Hz
15	0.033
80	0.177
200	0.177
234	0.111
500	0.111
535	0.097
1000	0.097
2000	0.024

4. Product Options

Table 4-1. MS12 Available Options

Power Supply		
Source Voltage	Voltage Input	Type
	DC 16-32VDC	Military Style Connector
Output Voltage ⁽¹⁾	DC Voltage Out	
	3.3 (Passive Only)	
	5.0	
	7.5	
RF Connector		
Connector	Connector Type	
	N (Female/Male)	N/A
	SMA (Female/Male)	N/A
	TNC (Female/Male)	N/A
Port ⁽¹⁾		
Pass DC	All Ports Pass DC	
DC Blocked	J3 is DC Blocked with 200Ω Load; DC is passed J2 to ANT(J1)	

Note: 1. Source Voltage Option:
Any or all RF ports (input or output) can be DC Blocked or can pass the powered DC voltage.

5. Product Code Decoder

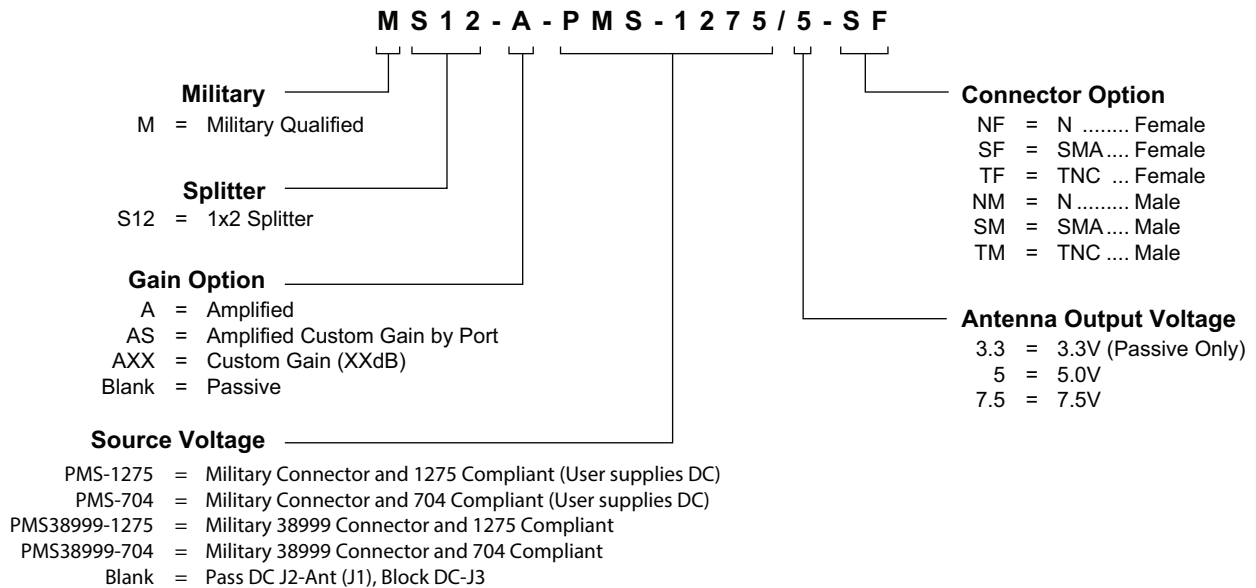

Note: To have product/part codes customized to meet exact needs, contact GPS Source at GPSS-Sales@gd-ms.com or visit the website at www.gpssource.com.

6. Mechanical Drawing

MS12 Regular Housing — FSA-ABA-AAY-AG

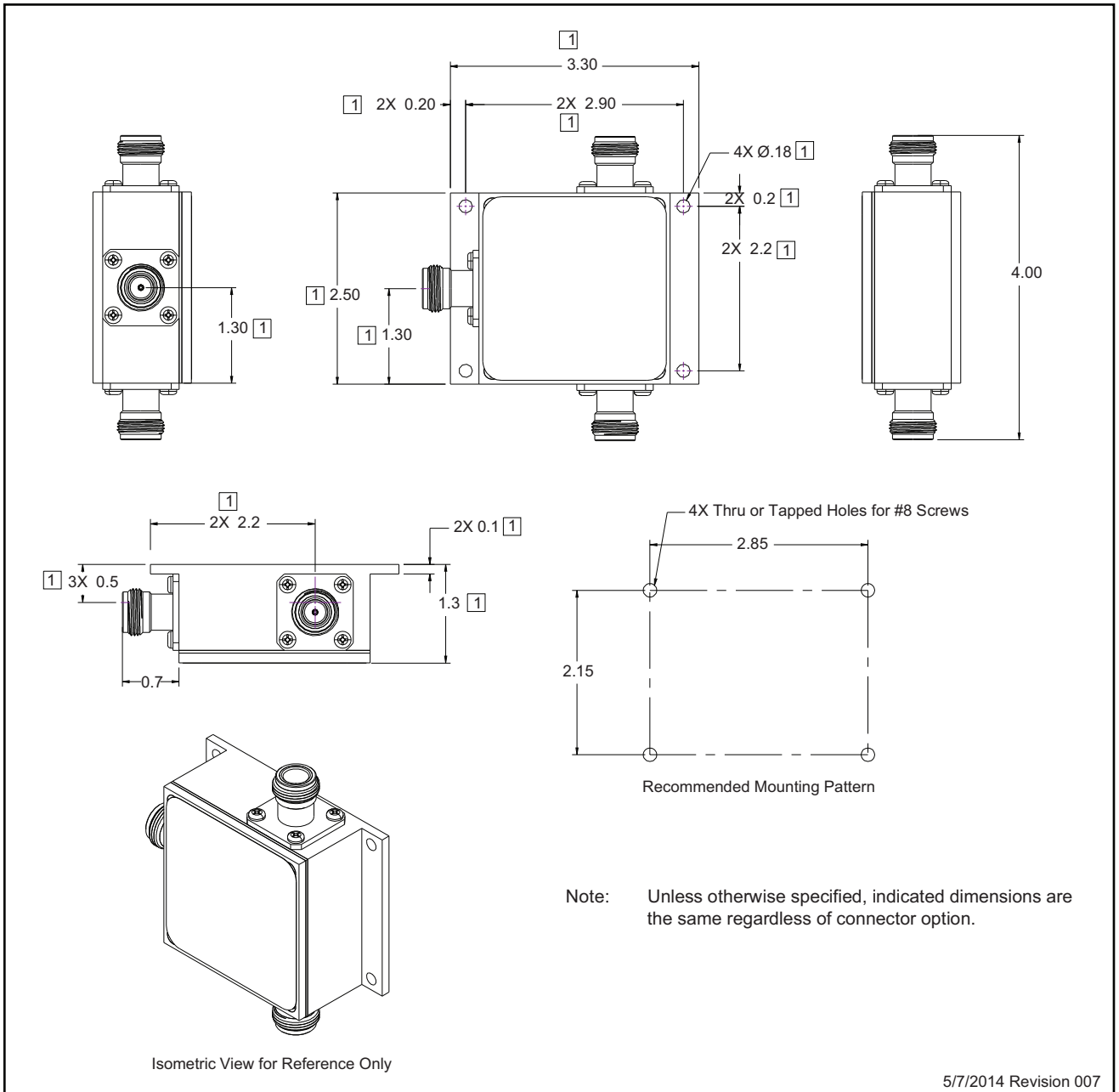

Note: Unless otherwise specified, indicated dimensions are the same regardless of connector option.

5/7/2014 Revision 007

GPS Source Part No. MS12	Finish Semi-Gloss Gray	Size C	Mass	Tolerances	
Description Military Qualified S12, 1 IN 2 OUT Splitter N-Type (F) Connector	Material N/A	3 rd Angle Projection 		Linear .X = ± 0.100 .XX = ± 0.010 .XXX = ± 0.005	Angular $\pm 1^\circ$ RADII See Linear
All materials and finishes shall comply with European Union RoHS and are lead free. Dimensions are in inches unless otherwise specified.					

MS12 Regular Housing Data Sheet

059-FSA-ABA-AA-Y-AG-014

Page 14 of 14, 09/01/2020



2121 Executive Cir., Ste 100
Colorado Springs, CO 80906
Phone: (+1)(719) 421.7300
Toll free: (+1)(866) 289.4777
GPSS-Sales@gd-ms.com
www.gpssource.com

AS9100 and ISO 9001 Compliant Company



© 2013 GPS Source, Inc. All rights reserved.

GPS Source, Inc., GPS Live Inside, GPS Source logo, and other GPS Source, Inc. products, brands, and trademarks mentioned in this document are property of GPS Source, Inc. and/or its affiliates in the United States and/or other countries. Other products, brands, and trademarks are property of their respective owners/companies. Any rights not expressly granted herein are reserved.

DISCLAIMER: The materials in this document could include inaccuracies or typographical errors and are subject to change at any time. The materials are provided "as is" without warranty of any kind. To the maximum extent permitted by applicable law, GPS Source, Inc. and its suppliers hereby disclaim all warranties, either expressed or implied, and conditions with respect to the materials, their quality, performance, suitability, merchantability, fitness for a particular purpose, title, and non-infringement. LIMITATION OF LIABILITY: IN NO EVENT WILL GPS SOURCE, INC. AND ITS SUPPLIERS BE LIABLE FOR INDIRECT, SPECIAL, INCIDENTAL, OR CONSEQUENTIAL DAMAGES, WHETHER IN AN ACTION OF CONTRACT OR TORT, ARISING OUT OF THE USE OR INABILITY TO USE THE MATERIALS AVAILABLE IN THIS DOCUMENT, EVEN IF ADVISED OF THE POSSIBILITY OF SUCH DAMAGES. IN PARTICULAR AND WITHOUT LIMITATION, GPS SOURCE, INC. SHALL HAVE NO LIABILITY FOR ANY LOSS OF USE, DATA, INCLUDING THE COSTS OF RECOVERING SUCH DATA, OR PROFITS.