

KTM/Husqvarna 2023 Footpeg Installation Instructions

Thank you for your purchase! We are confident that you will be pleased with the quality of our product.

1. Some models include an instruction addendum. Be sure to use the addendum along with this instruction sheet if one is included.
2. The Universal Collar System enables you to set up the footpeg up at the standard stock position. Insert the collar in the footpeg mounting hole from the top for a (standard) stock peg height. Collars will require a little pressure to install as they are a tapered press fit. This can be accomplished using the supplied cylinder tool from the opposite side. To remove the collar, simply use the supplied cylinder tool from the opposite side.
3. After you have installed the collar in the desired position, install the FKMS (Camber) bolt into each peg. Mount the peg on the bike without the return spring and check the angle of the peg. Add shims behind the camber bolt until the pegs are leveled, or if you choose you can add more shims so you can have a "knee-in" effect which some riders prefer. Once you are satisfied with the mounting position remove the FKMS bolt and clean the bolt and footpeg threads with primer or contact cleaner. Apply a thread locking compound on the bolt's thread and reinstall. Be sure to frequently check the camber bolts for tightness!
4. Install footpeg cleats in the pegs using the supplied thread locking compound. Two sizes are included for additional adjustment.
5. Mount the pegs to the bike re-using the stock frame pins. **Note:** Gold spring placement on the right, silver on the left when mounting the pegs in the lower position and gold spring on the left and silver on the right when mounting pegs in the standard position. Spring placement differs slightly on Adventure or Evolution Air pegs which fit in a milled hole. Some bike models may require the spring to be installed inside the bracket rather than hooked on the edge.

INSERT COLLAR ON TOP SIDE

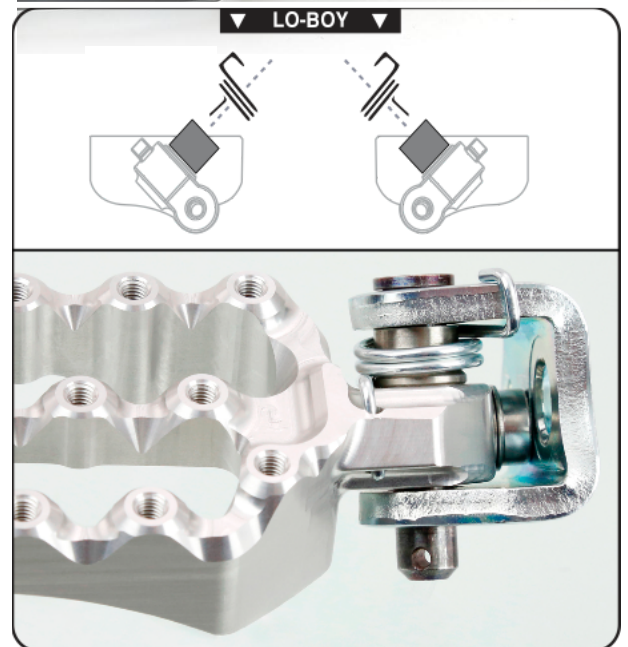
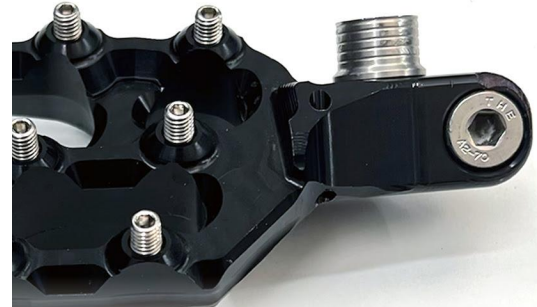

Cleat Positioning

All 10mm Cleats

Low profile and increased boot life

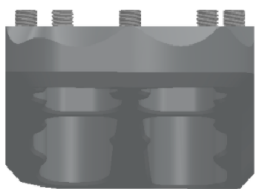

All 12mm Cleats

Aggressive traction

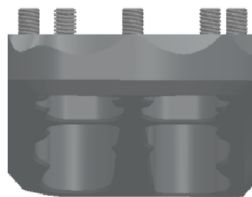

Tall Center Row

Keep feet locked on the peg with room to roll

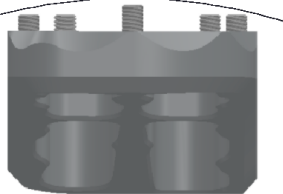

Tall Back Row

More toe freedom for braking and shifting

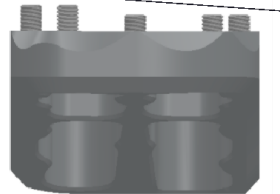

Cleats can be swapped out anywhere on the peg to keep your feet in exactly the right place.

Fastway footpegs - perfect feel for any setup!

F5 & F7 cleats are sold separately.



FKMS - Fast Kamber Mounting System - (patent # 6,339,972)

Our patented FKMS- Fast Kamber Mounting System uses shims to allow adjustment of the upward or downward tilt of your pegs.

Use more shims=knees closer to the bike; less shims=knees further apart.

Our new improved grade 8 zinc coated steel FKMS bolts are more durable than ever for long life and ease of adjustment.

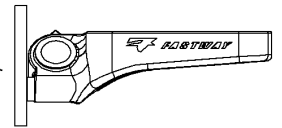
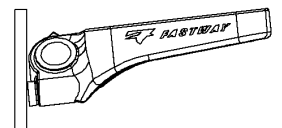

FKMS Bolt

