

RoHS COMPLIANT

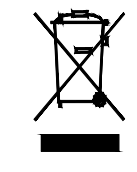

PATCHING SYSTEMS

AUDIO, VIDEO, SERIAL DATA

600 WEST ELK AVENUE
GLENDALE, CA. 91204

TEL 818 500-8142

FAX 818 500-7062

WWW.BITTREE.COM

DATA CONTAINED IN THIS DOCUMENT IS PROPRIETARY AND SHALL NOT BE DISCLOSED, COPIED OR USED FOR PROCUREMENT OR MANUFACTURE WITHOUT EXPRESS WRITTEN PERMISSION OF BITTREE INCORPORATED

DWG. NO.: 96T1MWTHDRE.DWG

PART NO.: G96T1MWTHD

DESIGNATION: DS430-10

LAYER (DS_INSERT) IS PROVIDED FOR THE CREATION OF LEGEND STRIPS FOR THIS PATCHBAY. THE RED OUTLINE MATCHES THE SIZE OF INSERT. PLEASE NOTE THE VIEWABLE AREA IS LISTED IN NOTES BELOW THE FRONT PANEL VIEW.

DWG. SCALE: FULL

PDF. SCALE: NONE

ALL POSSIBLE CARE HAS BEEN TAKEN IN PREPARING THIS SET OF DRAWINGS. STATEMENTS AND SPECIFICATIONS ARE BELIEVED TRUE BUT CANNOT BE GUARANTEED AND THEREFORE WE ARE NOT RESPONSIBLE FOR ANY INACCURACIES. THIS DOCUMENT SHOULD BE USED AS THE BASIS FOR DESIGN OR TO ESTABLISH SPECIFICATION LIMITS.

BITTREE RESERVES THE RIGHT TO CHANGE OR ALTER SPECIFICATIONS OR MATERIALS WITHOUT NOTICE. PROVIDED THE FUNCTION AND PERFORMANCE OF THE PRODUCT REMAINS REASONABLY SIMILAR OR IS IMPROVED.

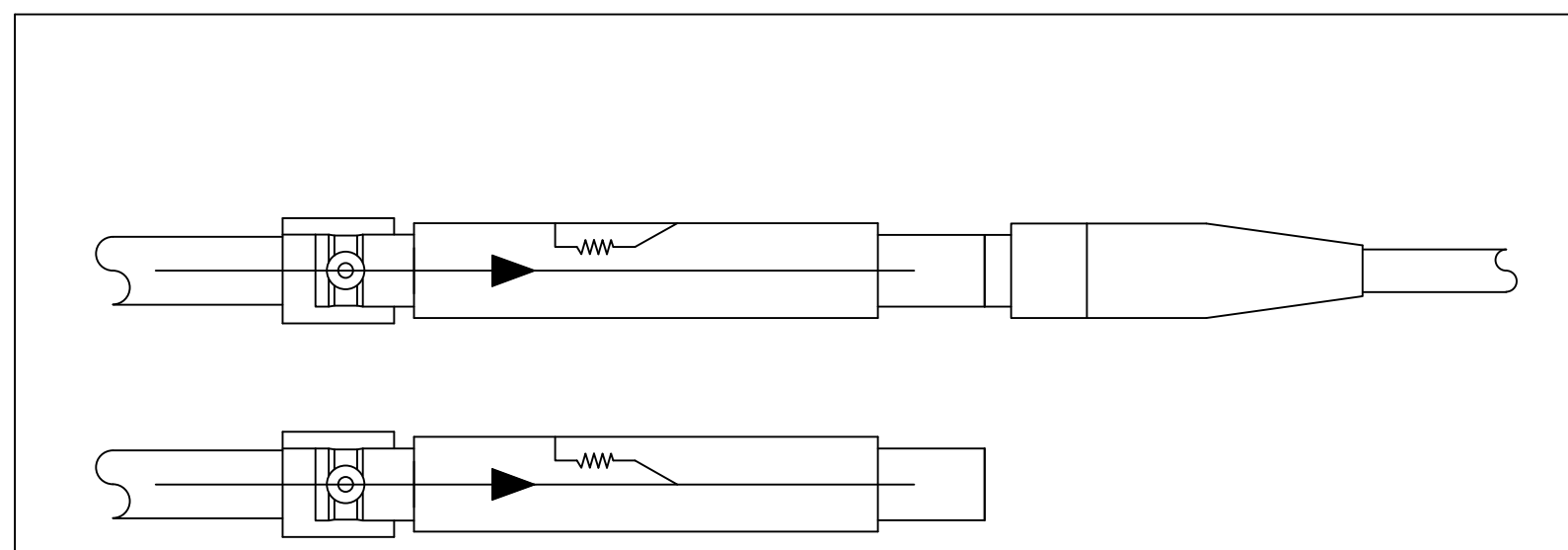

SHOWN AS SINGLE TERMINATED

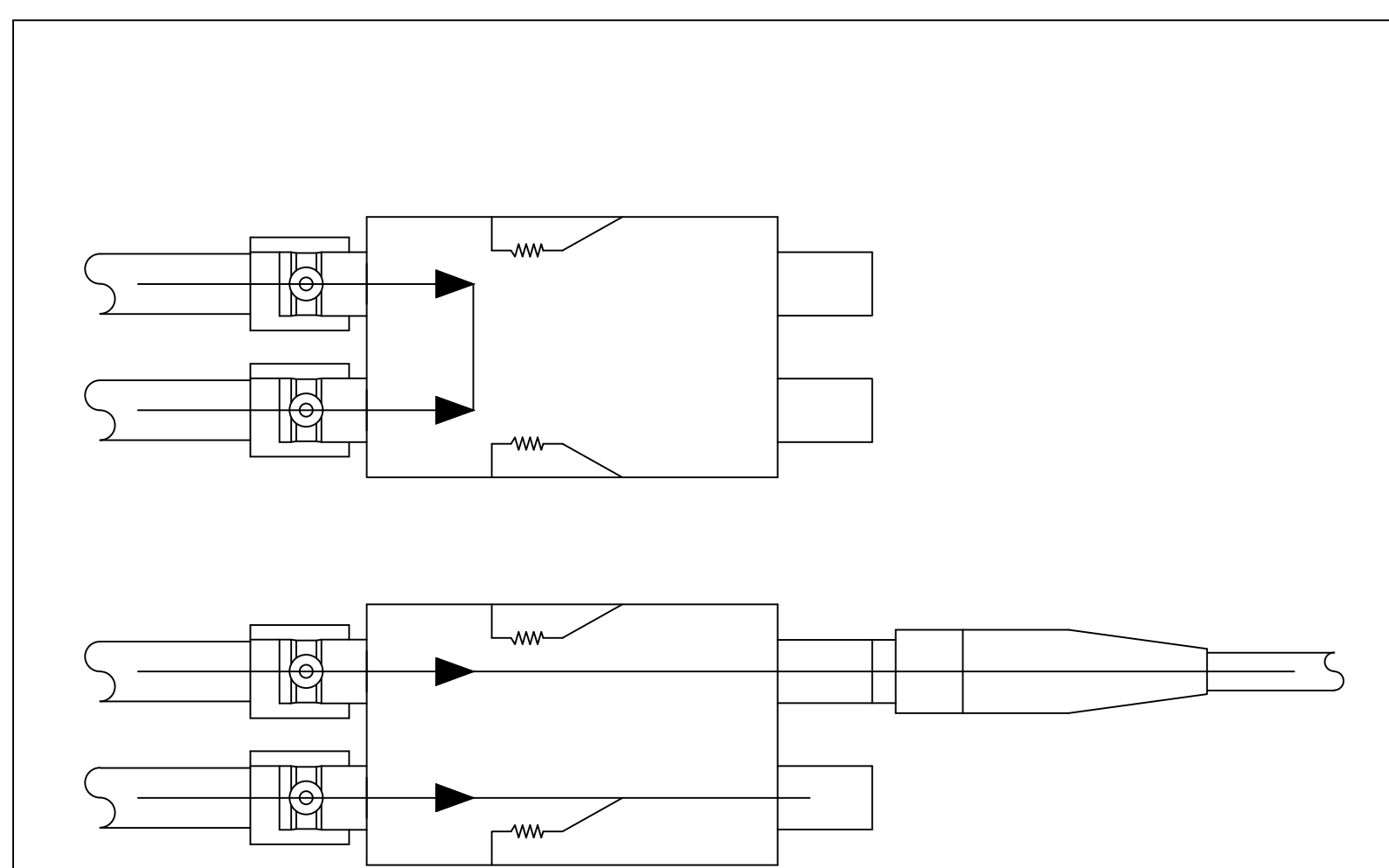

SHOWN AS NORMALED AND 75 OHM TERMINATED

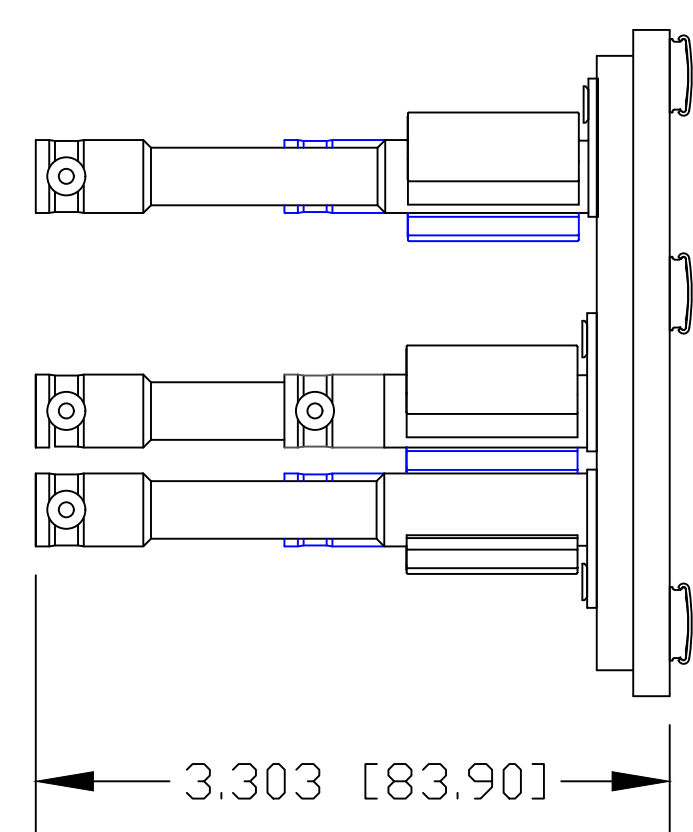

SIDE VIEW

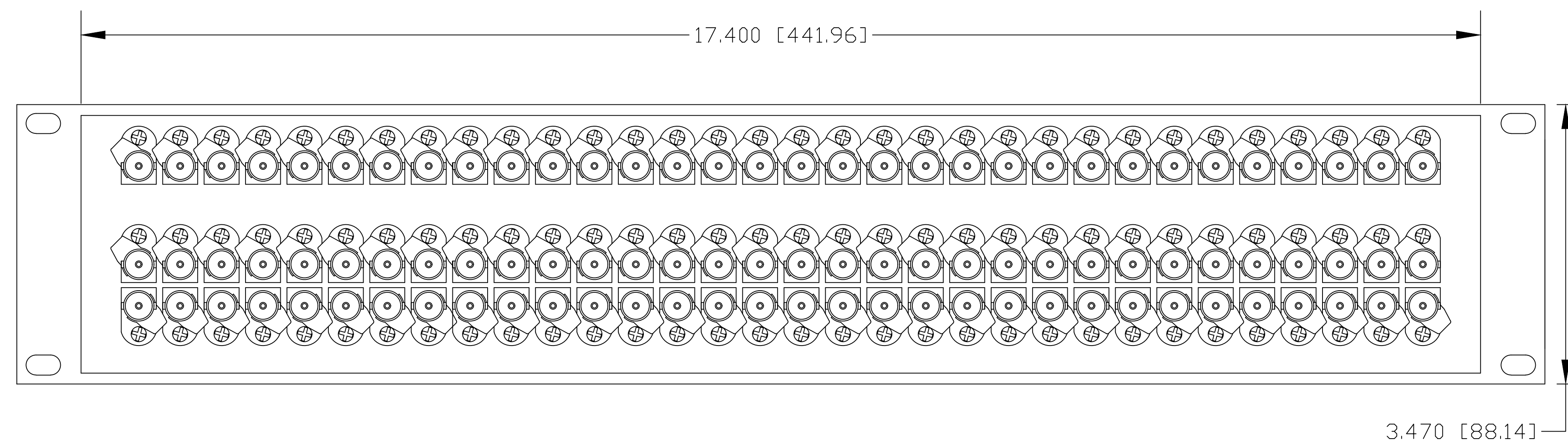

REAR VIEW

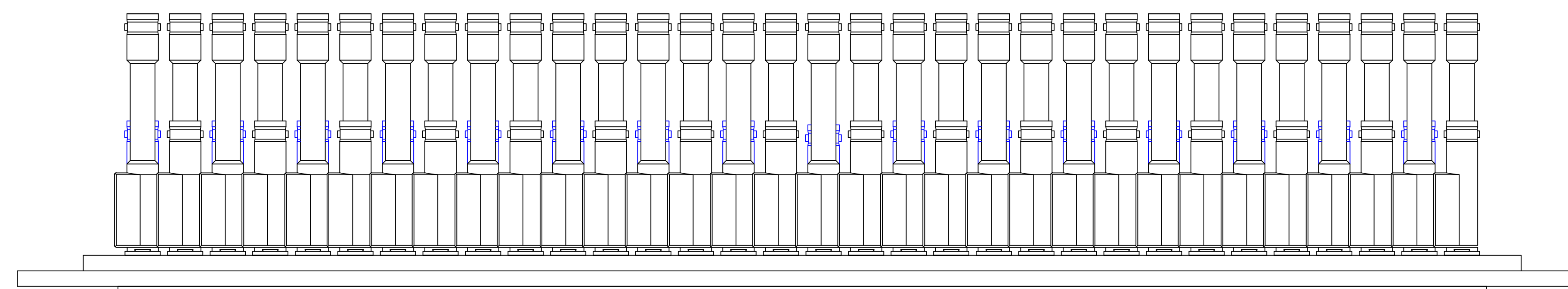

TOP VIEW

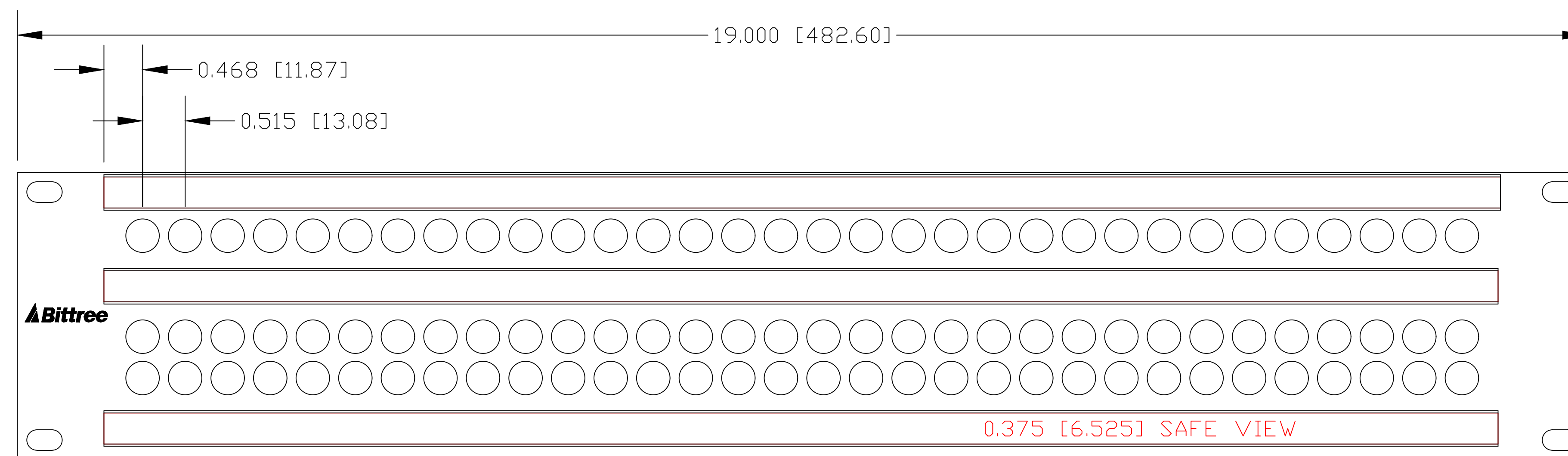

FRONT VIEW

DESIGNATION HOLDER: DS430-10/S, .382 [9.703]x16.90 [429.26]
SNAP-ON CAP: DS430-10/P, .430 [10.922]x16.9 [429.26]

NOTE: Ds_insert Layer is a scaled 1:1 label insert outline

REV.:

DATE: 9/18/2017

BY: G.S.

CHANGES: