



RoHS COMPLIANT



Bittree

PATCHING SYSTEMS

AUDIO, VIDEO, DATA
600 WEST ELK AVENUE
GLENDALE, CA. 91204
TEL 818 500-8142
FAX 818 500-7062
WWW.BITTREE.COM

DA88 STANDARD CHART FOR DB25 PIN-OUT

PAIR	HI	LO	SH
1	24	12	25
2	10	23	11
3	21	9	22
4	7	20	8
5	18	6	19
6	4	17	5
7	15	3	16
8	1	14	2

DB25 MALE CONNECTOR REAR VIEW

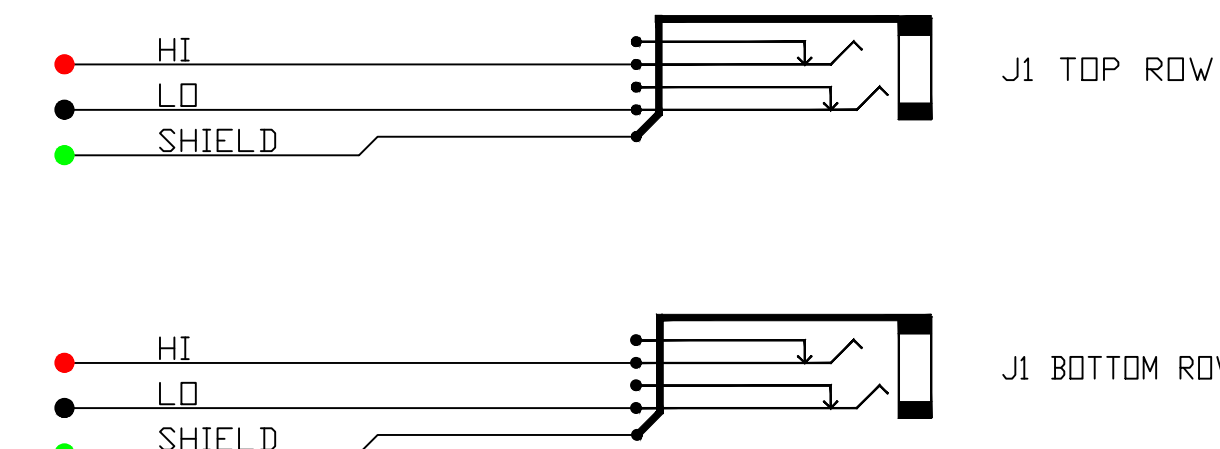
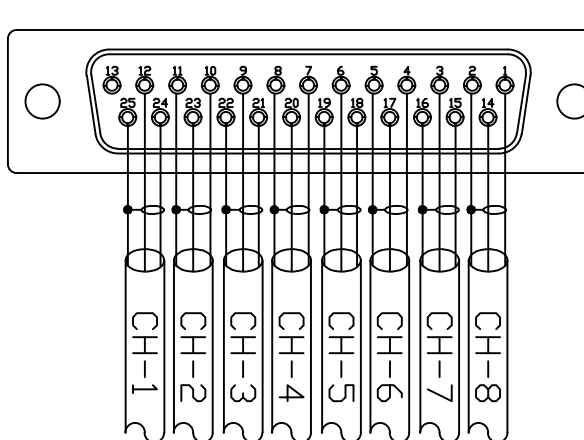

SCHEMATIC
NON-NORMALED ISOLATED GND VIEW

TOOLS AND ACCESSORIES PART NUMBERS

DESCRIPTION	PART NUMBER
PROGRAMMING SHUNTS (RED)	3B2811-9
PROGRAMMING SHUNTS (WHITE)	3B2811-0
LACING BAR 6IN (152.4MM)	LB-17500
LACING BAR 3IN (76.2MM)	LB175-3
DB25 MALE WITH SOLDER PIN	DS-25P/T
25 PIN DSUB METAL HOOD	DM-25C

DB25M CONNECTOR

MALE CONNECTOR FRONT VIEW

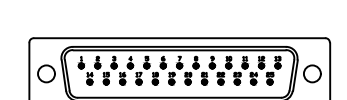

DB25 HOOD (BACKSHELL)

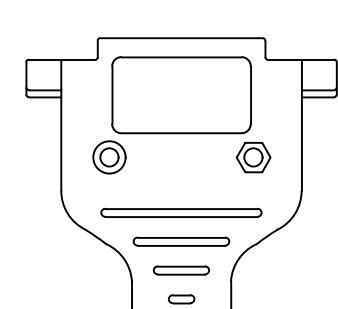

MALE CONNECTOR REAR VIEW

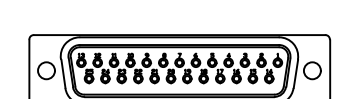

FOR PURCHASE OF MALE DB25M MATING HARDWARE
SEE ACCESSORIES DRAWING FOR PART NUMBERS.

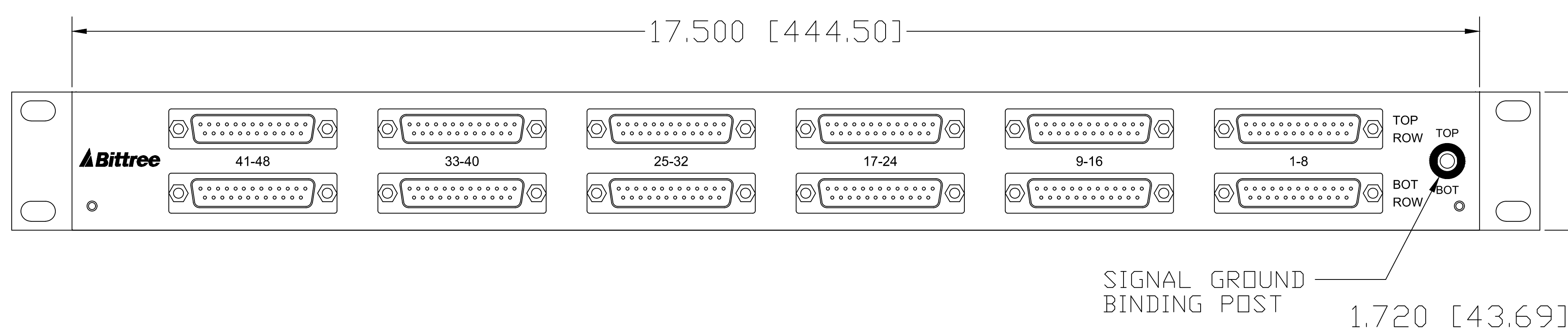

REAR VIEW

DATA CONTAINED IN THIS DOCUMENT IS PROPRIETARY AND SHALL NOT BE DISCLOSED, COPIED OR USED FOR PROCUREMENT OR MANUFACTURE WITHOUT EXPRESS WRITTEN PERMISSION OF BITTREE INCORPORATED

DWG. NO.: B96DCNNIISD25S2DU7B

PART NO.: B96DC-NNIIS/D25 S2DU7B

DESIGNATION: DS250-10-ASSY

DB25 CONNECTORS
SIGNAL GROUND BINDING POST

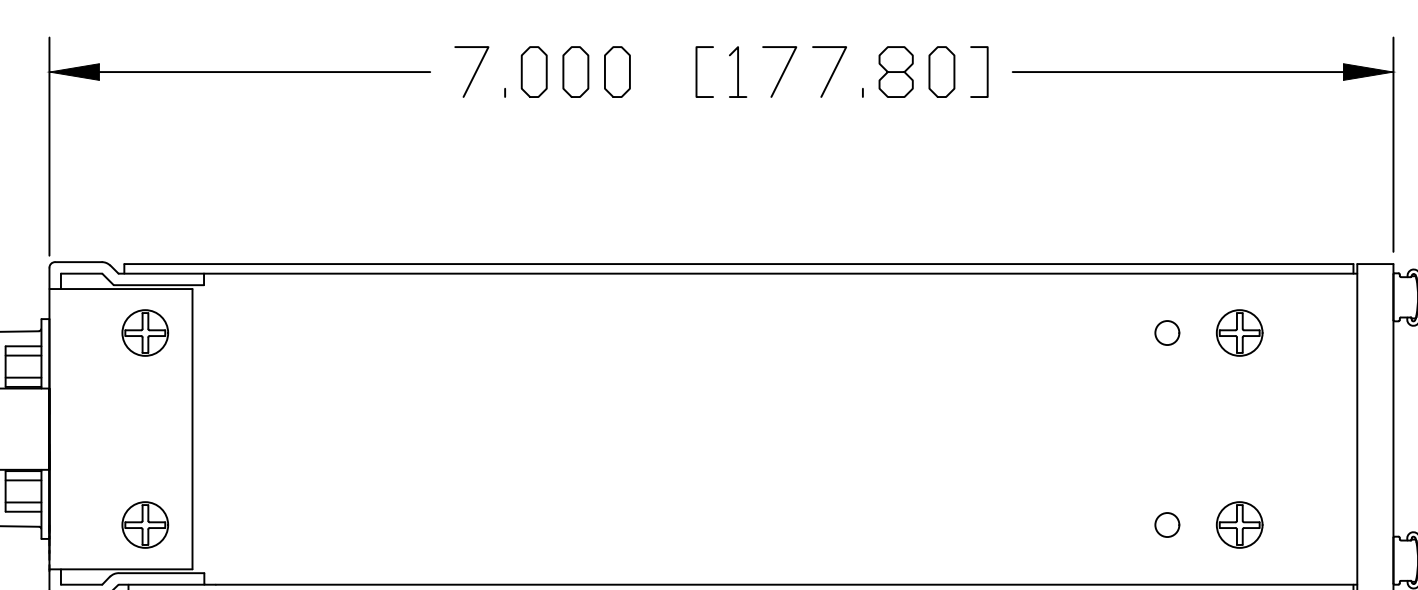

LEFT SIDE VIEW

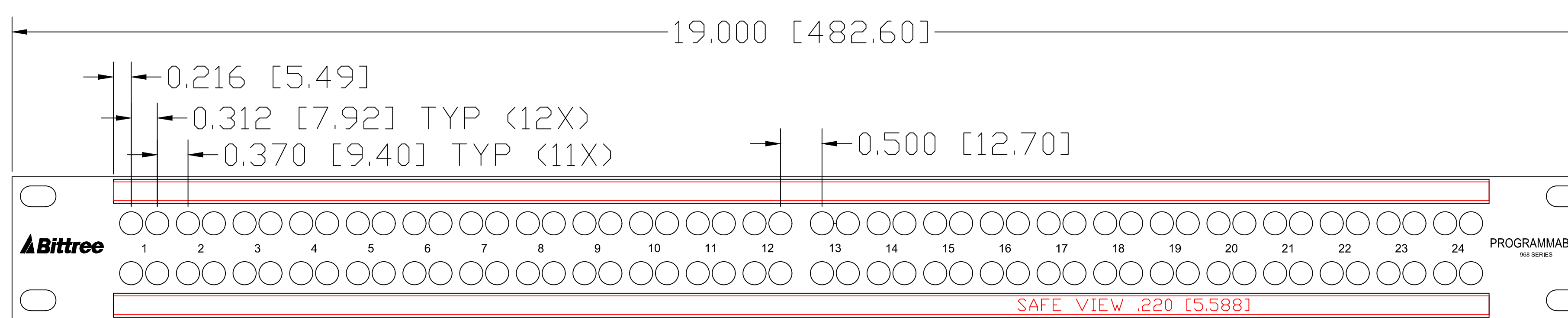

DESIGNATION:	PART NBR.	DIMENSIONS
DESIGNATION HOLDER	DS250-10/B,	.250 [6.350] x 16.560 [420.624]
SNAP-ON CAP	DS250-10/C,	.290 [7.336] x 16.560 [420.624]

FRONT VIEW

LAYER (DS_INSERT) IS PROVIDED FOR THE CREATION OF LEGEND STRIPS FOR THIS PATCHBAY. THE RED OUTLINE MATCHES THE SIZE OF INSERT. PLEASE NOTE THE VIEWABLE AREA IS LISTED IN NOTES BELOW THE FRONT PANEL VIEW.

DWG. SCALE: FULL

PDF. SCALE: NONE

ALL POSSIBLE CARE HAS BEEN TAKEN IN PREPARING THIS SET OF DRAWINGS. STATEMENTS AND SPECIFICATIONS ARE BELIEVED TRUE BUT CANNOT BE GUARANTEED AND THEREFORE WE ARE NOT RESPONSIBLE FOR ANY INACCURACIES. THIS DOCUMENT SHOULD BE USED AS THE BASIS FOR DESIGN OR TO ESTABLISH SPECIFICATION LIMITS.

BITTREE RESERVES THE RIGHT TO CHANGE OR ALTER SPECIFICATIONS OR MATERIALS WITHOUT NOTICE. PROVIDED THE FUNCTION AND PERFORMANCE OF THE PRODUCT REMAINS REASONABLY SIMILAR OR IS IMPROVED.

REV.:	DATE: 10/31/2017	BY: G.S.	CHANGES:
-------	------------------	----------	----------