

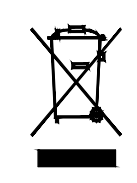

RoHS COMPLIANT



PATCHING SYSTEMS

AUDIO, VIDEO, DATA
600 WEST ELK AVENUE
GLENDALE, CA. 91204
TEL 818 500-8142
FAX 818 500-7062
WWW.BITTREE.COM

E90 PIN-OUT

CHANNEL	PR	RIGHT	LR	SHIELD	LEFT	RIGHT
1	A	H	R	S		
2	B	J	S			
3	C	K	T			
4	D	L	U			
5	E	M	V			
6	F	N	W			
7	X	AE	AM			
8	Y	AF	AN			
9	Z	AH	AP			
10	AA	AJ	AR			
11	AB	AK	AS			
12	AC	AL	AT			
13	AD	AM	AV			
14	AE	AN	AW			
15	AF	AO	AX			
16	AG	AP	AY			
17	AH	AQ	AZ			
18	AI	AR	BA			
19	AJ	AS	BB			
20	AK	AT	BC			
21	AL	AV	BD			
22	AM	AW	BE			
23	AN	AX	BF			
24	AO	AY	BG			
25	AP	AZ	BH			
26	AQ	BA	BI			

MALE CONNECTOR REAR VIEW
(CONTACT INSERTION PATTERN)

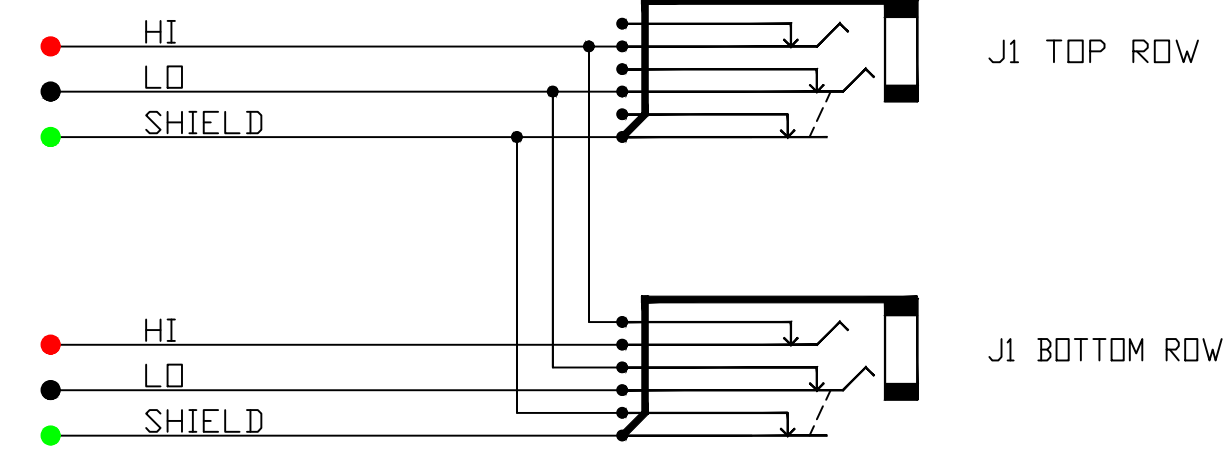
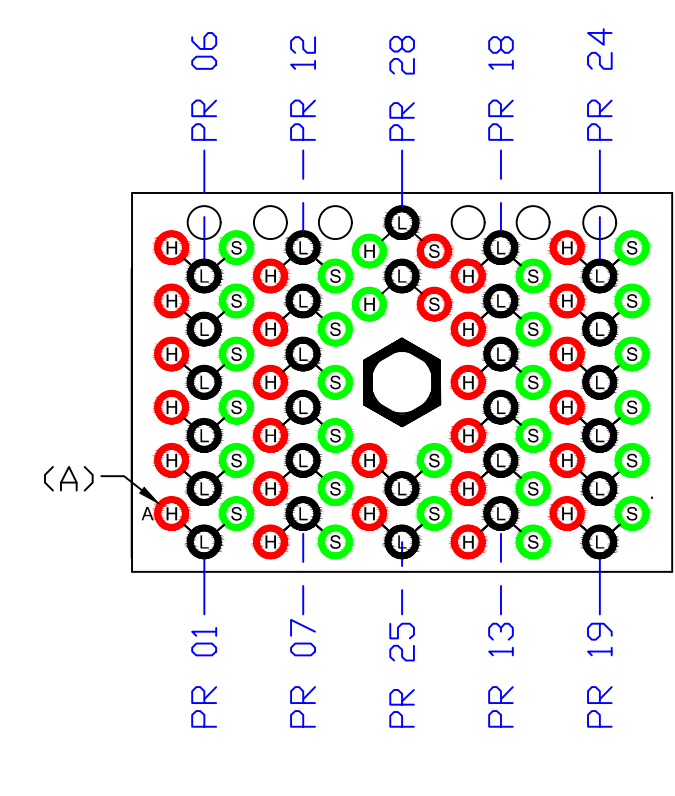

SCHEMATIC
HALF-NORMALED SWITCHED GND VIEW

TOOLS AND ACCESSORIES PART NUMBERS

DESCRIPTION	PART NUMBER
CONTACT CRIMP TOOL	K2MA-01
CONTACT REMOVAL TOOL	S16-280-300
CONTACT INSERTION TOOL	S16-280-400
90 PIN MALE CONNECTOR WITH SCREW	E90MS
90 PIN FEMALE CONNECTOR WITH NUT	E90FN
CONNECTOR CONTACTS (PINS)	EPIN
REPLACEMENT HARDWARE KIT	9690R
PROGRAMMING SHUNTS (RED)	382811-9
PROGRAMMING SHUNTS (WHITE)	382811-0

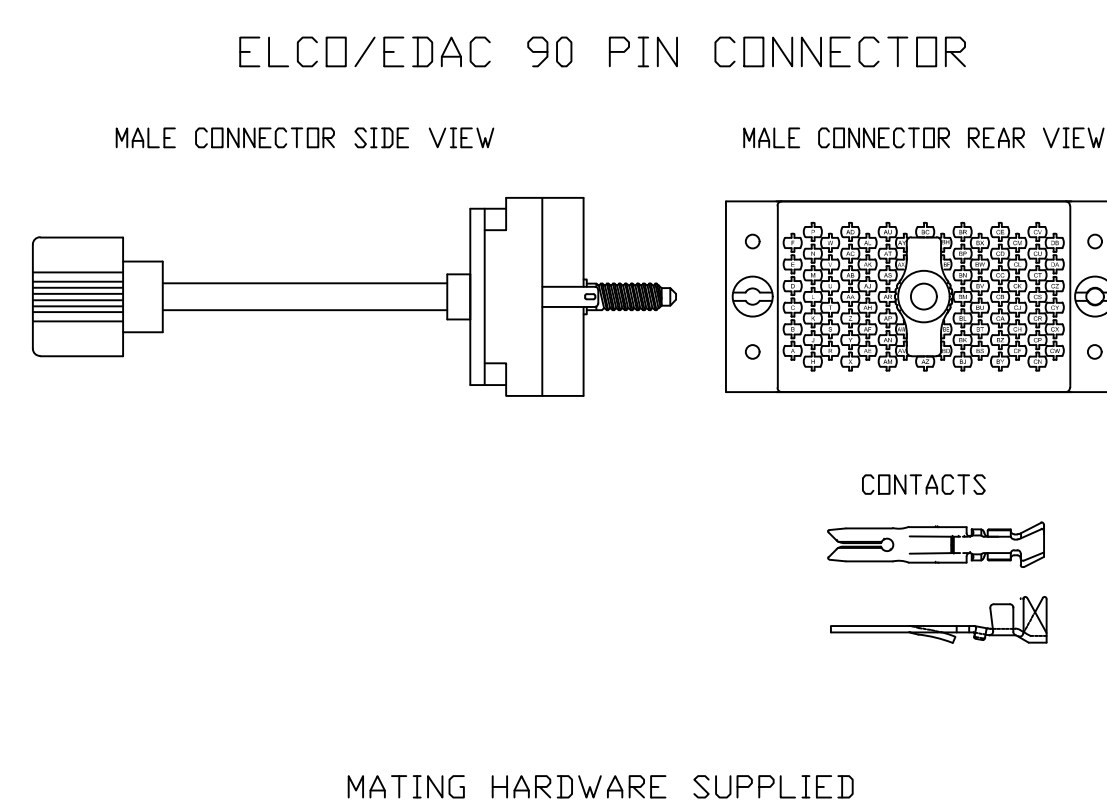

MATING HARDWARE SUPPLIED
FOR PURCHASE OF ADDITIONAL MATING HARDWARE
SEE ACCESSORIES DRAWING FOR PART NUMBERS.

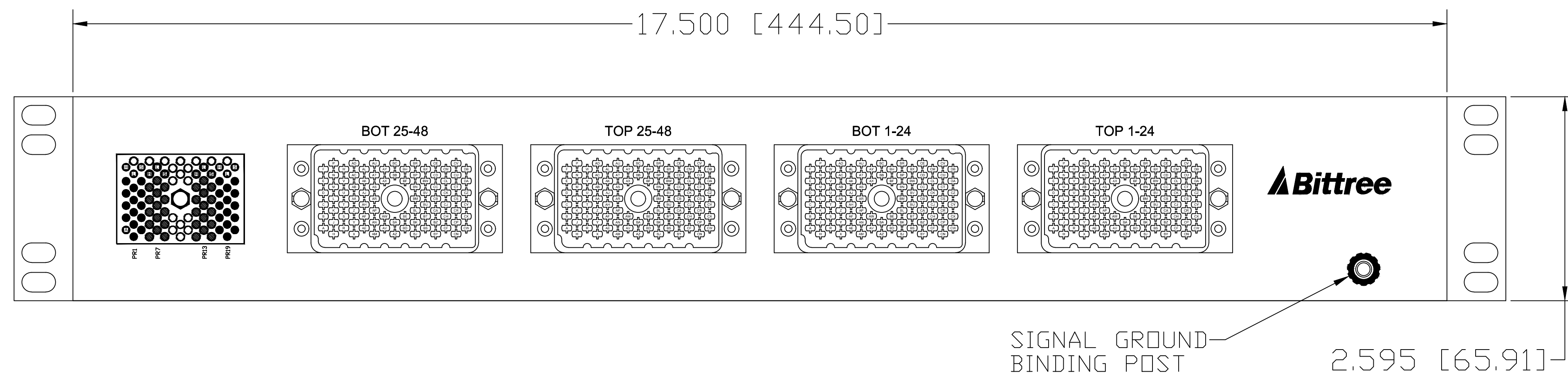

REAR VIEW

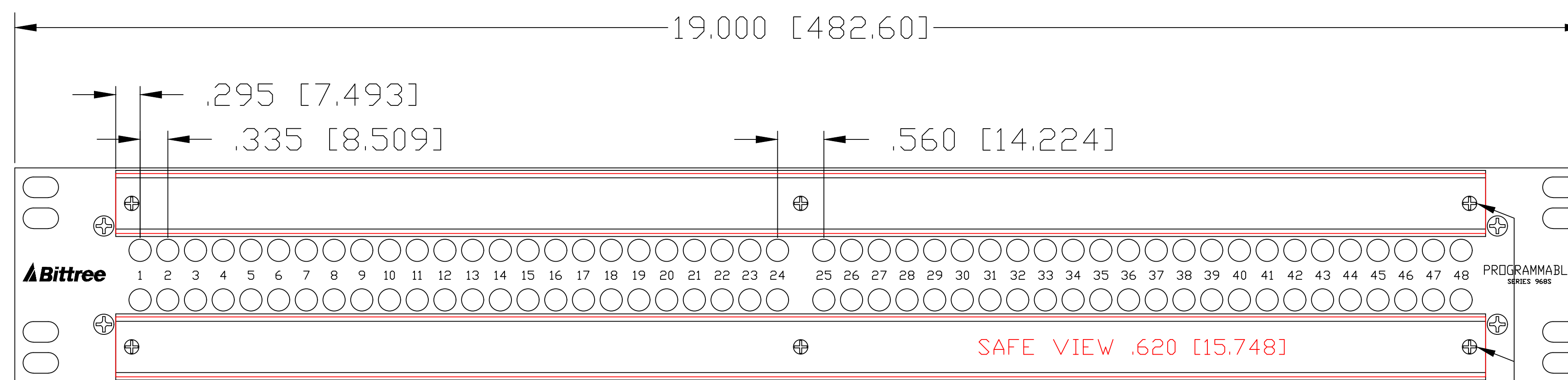
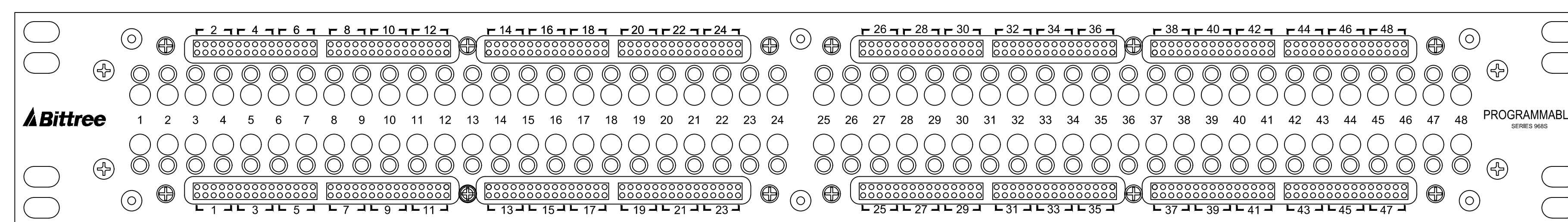

DESIGNATION:	PART NBR.	DIMENSIONS
STAINLESS STEEL HOLDERS:	DS800-10/S,	.800 [20.320] x 16.560 [420.624]
TRANSLUCENT LEXAN INSERTS:	DS800-10/P,	.725 [18.415] x 16.560 [420.624]
WHITE STYRENE INSERTS:	DS800-10/D,	.725 [18.415] x 16.560 [420.624]

REMOVE SCREWS
TO ACCESS
PROGRAMMING
SHUNTS (6X)

LEFT SIDE VIEW

FRONT VIEWS

NOTE: DS_INSERT LAYER IS A SCALED 1:1 LABEL INSERT OUTLINE

DATA CONTAINED IN THIS DOCUMENT
IS PROPRIETARY AND SHALL NOT BE
DISCLOSED, COPIED OR USED FOR
PROCUREMENT OR MANUFACTURE
WITHOUT EXPRESS WRITTEN PERMISSION
OF BITTREE INCORPORATED

DWG. NO.:
B96DCHNRSHE90M2DU12B
PART NO.:
B96DC-HNRSH/E90 M2DU12B
DESIGNATION: DS800-10-ASSY

LAYER (DS_INSERT) IS PROVIDED
FOR THE CREATION OF LEGEND
STRIPS FOR THIS PATCHBAY. THE
RED OUTLINE MATCHES THE SIZE
OF INSERT.
PLEASE NOTE THE VIEWABLE AREA
IS LISTED IN NOTES BELOW THE
FRONT PANEL VIEW.

DWG. SCALE: FULL

PDF. SCALE: NONE

ALL POSSIBLE CARE HAS BEEN TAKEN IN
PREPARING THIS SET OF DRAWINGS.
STATEMENTS AND SPECIFICATIONS ARE
BELIEVED TRUE BUT CANNOT BE
GUARANTEED AND THEREFORE WE ARE
NOT RESPONSIBLE FOR ANY
INACCURACIES. THIS DOCUMENT SHOULD
BE USED AS THE BASIS FOR DESIGN OR
TO ESTABLISH SPECIFICATION LIMITS.

BITTREE RESERVES THE RIGHT TO
CHANGE OR ALTER SPECIFICATIONS OR
MATERIALS WITHOUT NOTICE. PROVIDED
THE FUNCTION AND PERFORMANCE OF
THE PRODUCT REMAINS REASONABLY
SIMILAR OR IS IMPROVED.

REV.:	DATE: 10/27/2017	BY: G.S.	CHANGES:
-------	------------------	----------	----------