

RoHS COMPLIANT

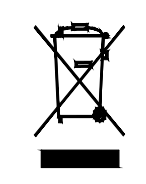

Bittree PATCHING SYSTEMS

AUDIO, VIDEO, DATA

600 WEST ELK AVENUE
GLENDALE, CA, 91204

TEL 818 500-8142

FAX 818 500-7062

WWW.BITTREE.COM

DATA CONTAINED IN THIS DOCUMENT IS PROPRIETARY AND SHALL NOT BE DISCLOSED, COPIED OR USED FOR PROCUREMENT OR MANUFACTURE WITHOUT EXPRESS WRITTEN PERMISSION OF BITTREE INCORPORATED

DWG. NO.:
B96DCHNRSHE3S2DU7B

PART NO.:
B96DC-HNRSH/E3 S2DU7B

DESIGNATION: DS800-10-ASSY

LAYER (DS_INSERT) IS PROVIDED FOR THE CREATION OF LEGEND STRIPS FOR THIS PATCHBAY. THE RED OUTLINE MATCHES THE SIZE OF INSERT. PLEASE NOTE THE VIEWABLE AREA IS LISTED IN NOTES BELOW THE FRONT PANEL VIEW.

DWG. SCALE: FULL

PDF. SCALE: NONE

ALL POSSIBLE CARE HAS BEEN TAKEN IN PREPARING THIS SET OF DRAWINGS. STATEMENTS AND SPECIFICATIONS ARE BELIEVED TRUE BUT CANNOT BE GUARANTEED AND THEREFORE WE ARE NOT RESPONSIBLE FOR ANY INACCURACIES. THIS DOCUMENT SHOULD BE USED AS THE BASIS FOR DESIGN OR TO ESTABLISH SPECIFICATION LIMITS.

BITTREE RESERVES THE RIGHT TO CHANGE OR ALTER SPECIFICATIONS OR MATERIALS WITHOUT NOTICE. PROVIDED THE FUNCTION AND PERFORMANCE OF THE PRODUCT REMAINS REASONABLY SIMILAR OR IS IMPROVED.

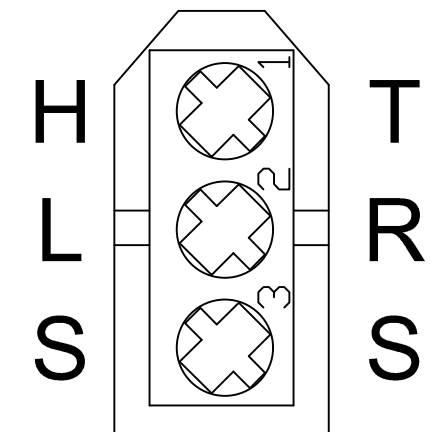

BITTREE 3 PIN CONNECTOR
REAR VIEW PIN-OUT

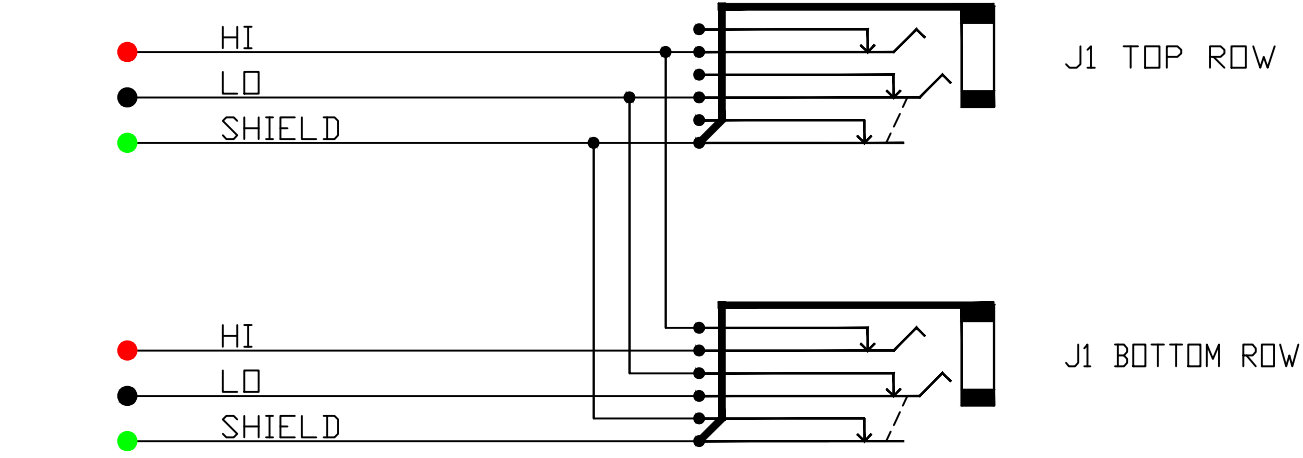

SCHEMATIC
HALF-NORMALED SWITCHED GND VIEW

TOOLS AND ACCESSORIES PART NUMBERS

DESCRIPTION	PART NUMBER
CONTACT CRIMP TOOL	K2MA-01
CONTACT REMOVAL TOOL	516-280-300
CONTACT INSERTION TOOL	516-280-400
BITTREE MALE CONNECTOR	E3M
BITTREE FEMALE CONNECTOR	E3F
CONNECTOR CONTACTS (PINS)	EPIN
REPLACEMENT HARDWARE KIT	9603R
PROGRAMMING SHUNTS (RED)	382811-9
PROGRAMMING SHUNTS (WHITE)	382811-0
LACING BAR 6IN (152.4MM)	LB-17500
LACING BAR 3IN (76.2MM)	LB175-3

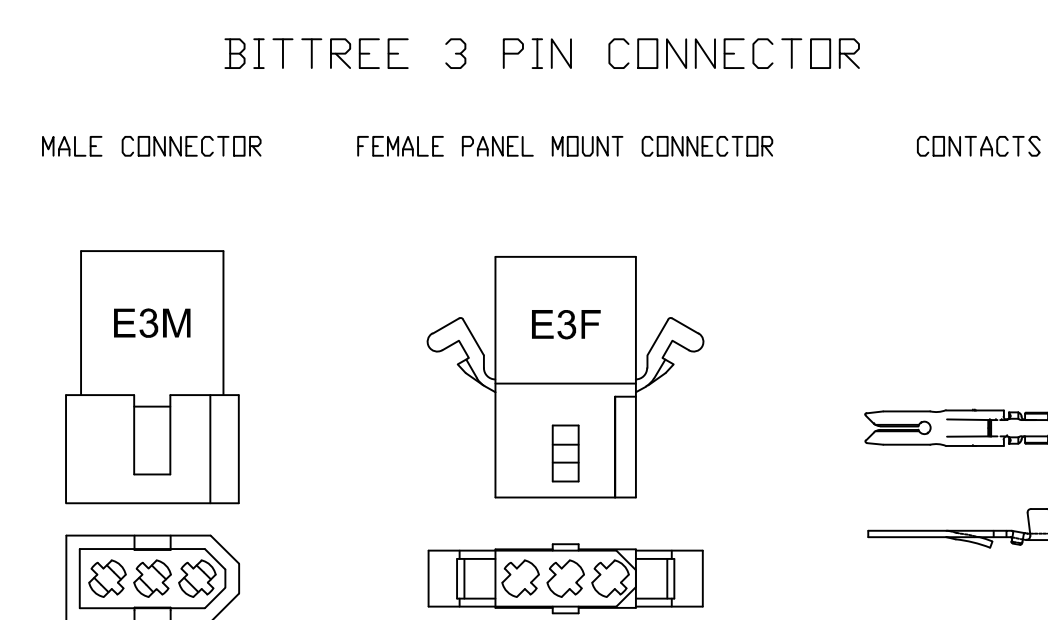

MATING HARDWARE SUPPLIED

FOR PURCHASE OF ADDITIONAL MATING HARDWARE
SEE ACCESSORIES DRAWING FOR PART NUMBERS.

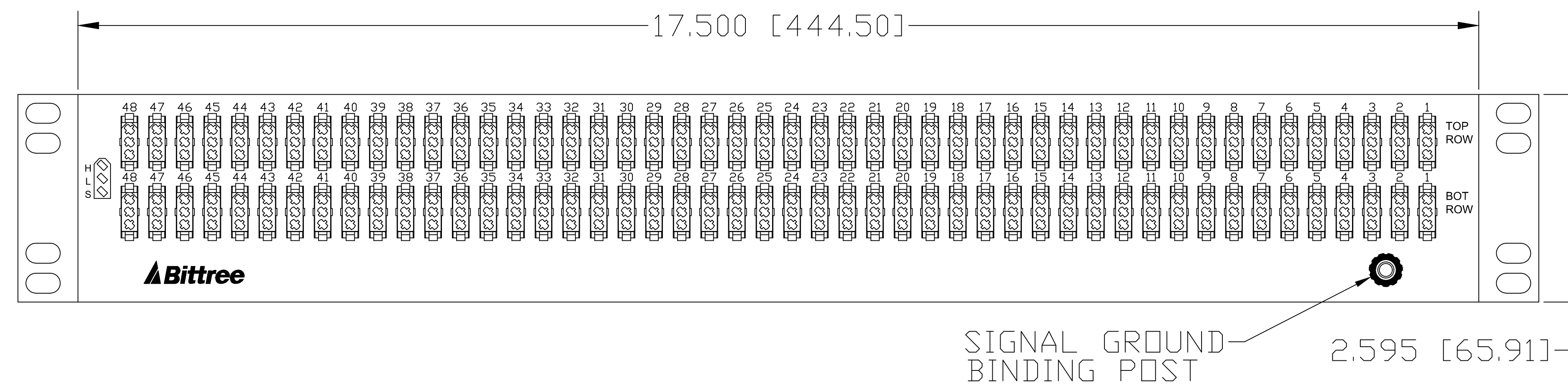

REAR VIEW

E3F CONNECTORS

SIGNAL GROUND
BINDING POST

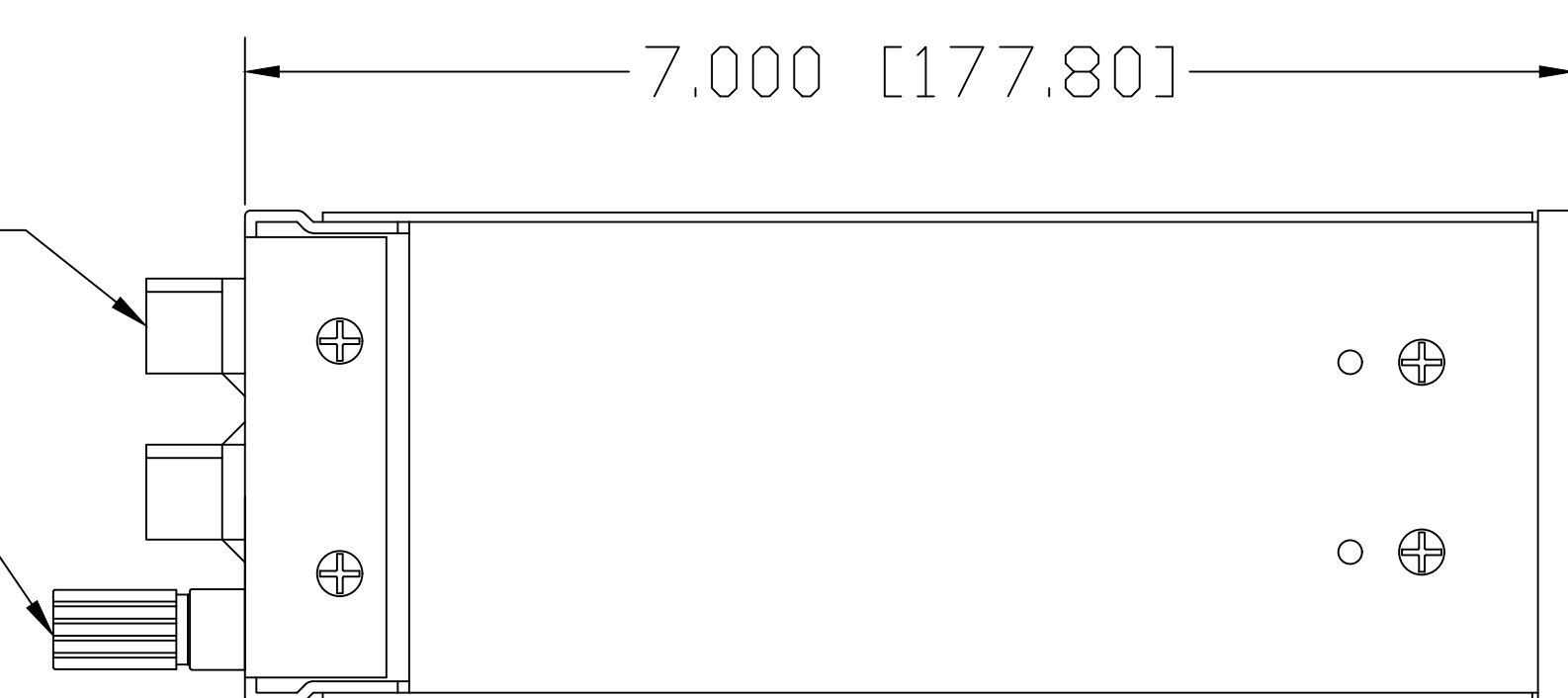

LEFT SIDE VIEW

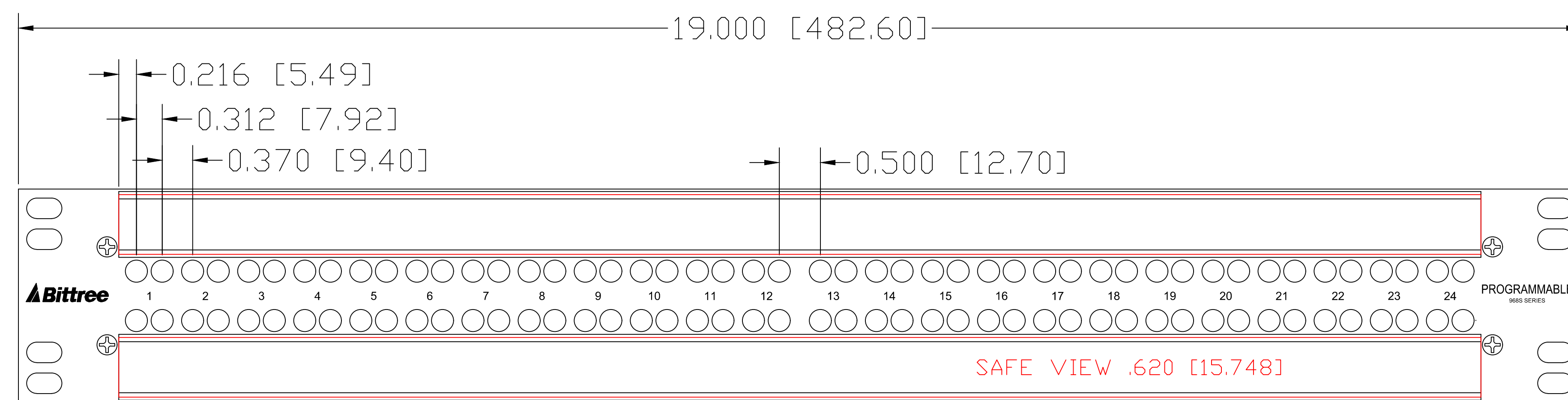

FRONT VIEW

DESIGNATION:	PART NBR.	DIMENSIONS
STAINLESS STEEL HOLDERS:	DS800-10/S,	.800 [20.320] x 16.560 [420.624]
TRANSLUCENT LEXAN INSERTS:	DS800-10/P,	.725 [18.415] x 16.560 [420.624]
WHITE STYRENE INSERTS:	DS800-10/D,	.725 [18.415] x 16.560 [420.624]

REV.:

DATE: 11/7/2017

BY: G.S.

CHANGES: