

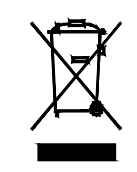

RoHS COMPLIANT



### PATCHING SYSTEMS

AUDIO, VIDEO, DATA  
600 WEST ELK AVENUE  
GLENDALE, CA. 91204  
TEL 818 500-8142  
FAX 818 500-7062  
WWW.BITTREE.COM

#### DA88 STANDARD CHART FOR DB25 PIN-OUT

PAIR	HI	LO	SH
1	24	12	25
2	10	23	11
3	21	9	22
4	7	20	8
5	18	6	19
6	4	17	5
7	15	3	16
8	1	14	2

#### DB25 MALE CONNECTOR REAR VIEW

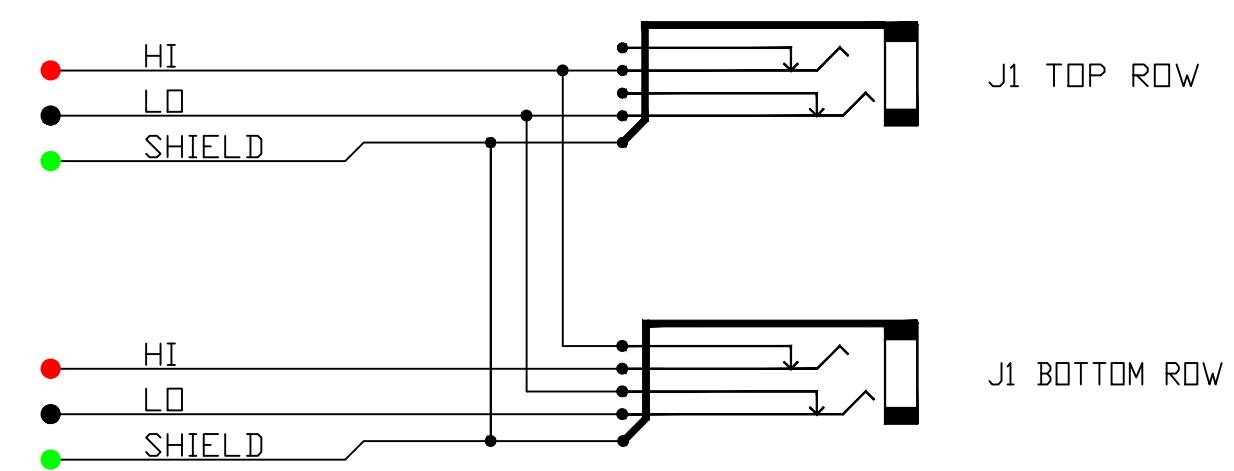
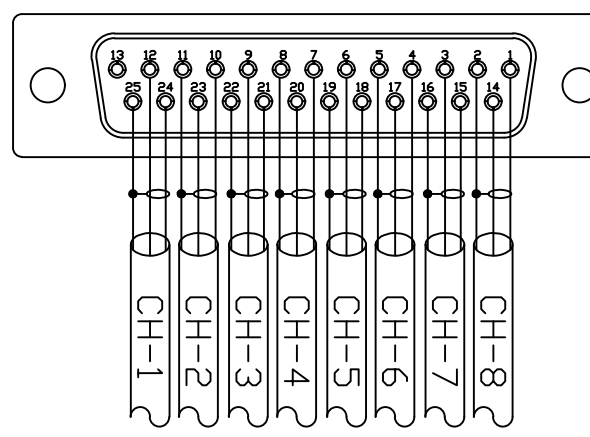

#### SCHEMATIC HALF-NORMALED LOOPED GND VIEW

#### TOOLS AND ACCESSORIES PART NUMBERS

DESCRIPTION	PART NUMBER
PROGRAMMING SHUNTS (RED)	382811-9
PROGRAMMING SHUNTS (WHITE)	382811-0
LACING BAR 6IN (152.4MM)	LB-17500
LACING BAR 3IN (76.2MM)	LB175-3
DB25 MALE WITH SOLDER PIN	DS-25P/T
25 PIN DSUB METAL HOOD	DM-25C

#### DB25M CONNECTOR

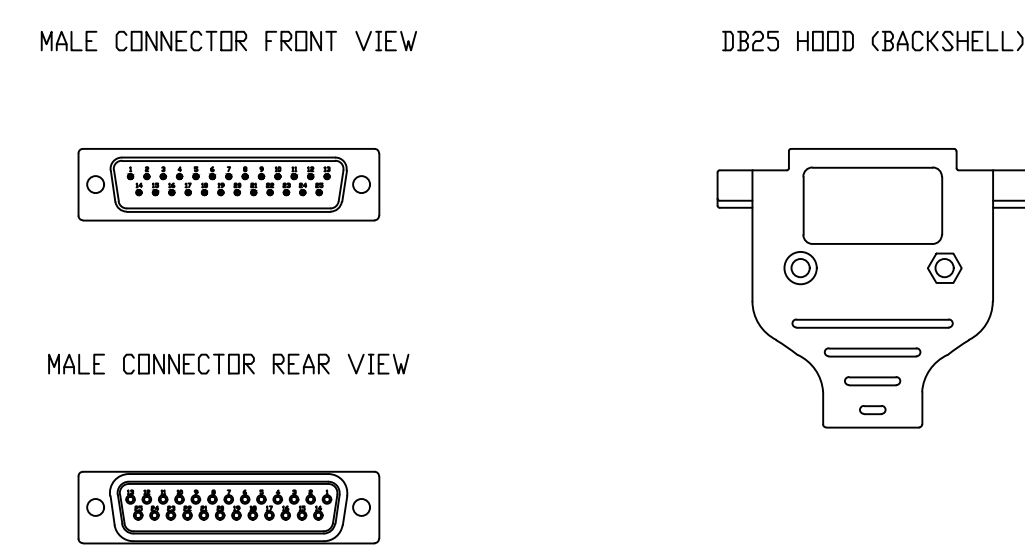

FOR PURCHASE OF MALE DB25M MATING HARDWARE  
SEE ACCESSORIES DRAWING FOR PART NUMBERS.

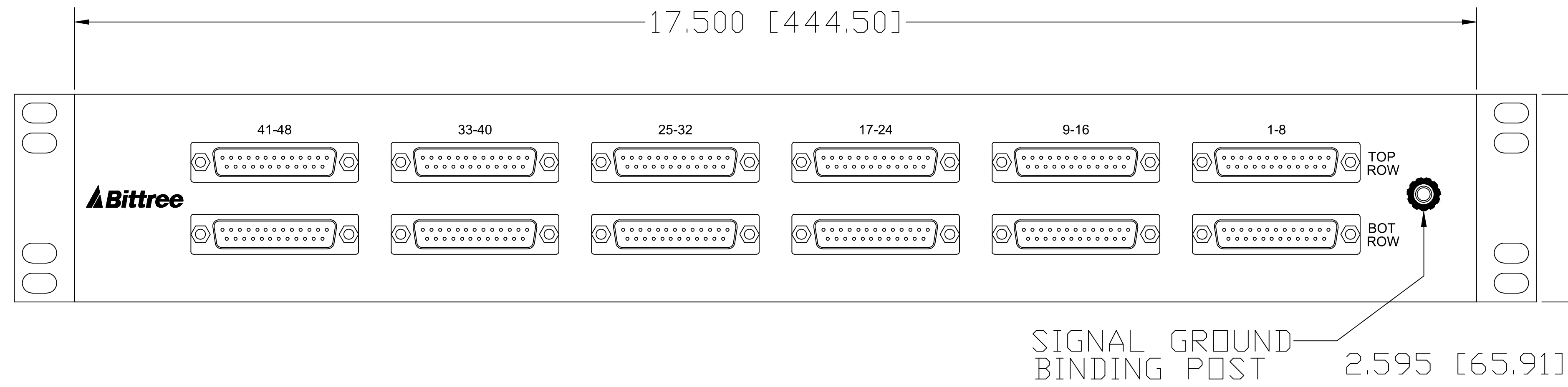

### REAR VIEW

DATA CONTAINED IN THIS DOCUMENT  
IS PROPRIETARY AND SHALL NOT BE  
DISCLOSED, COPIED OR USED FOR  
PROCUREMENT OR MANUFACTURE  
WITHOUT EXPRESS WRITTEN PERMISSION  
OF BITTREE INCORPORATED

DWG. NO.:  
B96DCHNILHD25S2OU12B  
PART NO.:  
B96DC-HNILH/D25 S2OU12B  
DESIGNATION: DS800-10-ASSY

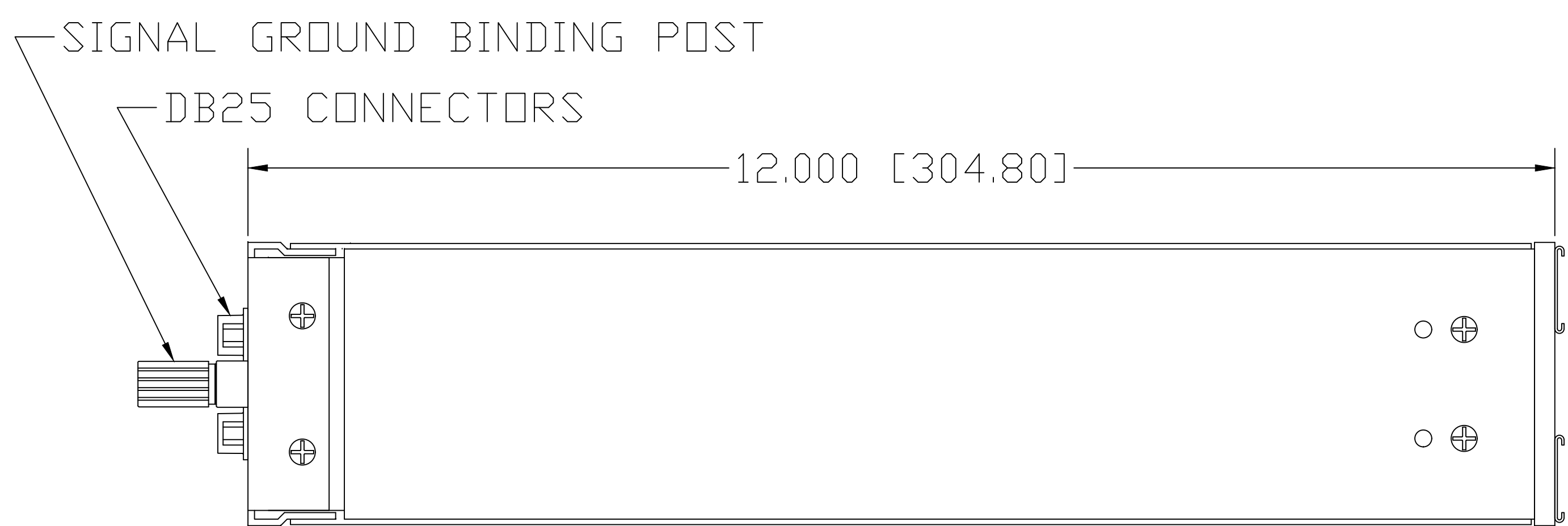

### LEFT SIDE VIEW

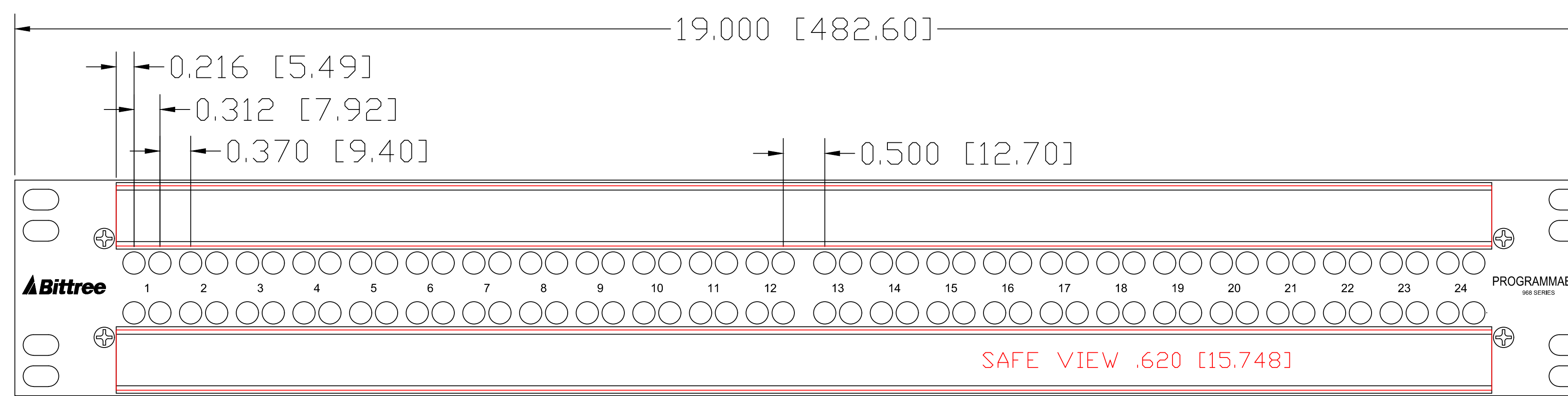

### FRONT VIEW

DESIGNATION:	PART NBR.	DIMENSIONS
STAINLESS STEEL HOLDERS:	DS800-10/S,	.800 [20.320] x 16.560 [420.624]
TRANSLUCENT LEXAN INSERTS:	DS800-10/P,	.725 [18.415] x 16.560 [420.624]
WHITE STYRENE INSERTS:	DS800-10/D,	.725 [18.415] x 16.560 [420.624]

LAYER (DS\_INSERT) IS PROVIDED  
FOR THE CREATION OF LEGEND  
STRIPS FOR THIS PATCHBAY. THE  
RED OUTLINE MATCHES THE SIZE  
OF INSERT.  
PLEASE NOTE THE VIEWABLE AREA  
IS LISTED IN NOTES BELOW THE  
FRONT PANEL VIEW.

DWG. SCALE: FULL

PDF. SCALE: NONE

ALL POSSIBLE CARE HAS BEEN TAKEN IN  
PREPARING THIS SET OF DRAWINGS.  
STATEMENTS AND SPECIFICATIONS ARE  
BELIEVED TRUE BUT CANNOT BE  
GUARANTEED AND THEREFORE WE ARE  
NOT RESPONSIBLE FOR ANY  
INACCURACIES. THIS DOCUMENT SHOULD  
BE USED AS THE BASIS FOR DESIGN OR  
TO ESTABLISH SPECIFICATION LIMITS.

BITTREE RESERVES THE RIGHT TO  
CHANGE OR ALTER SPECIFICATIONS OR  
MATERIALS WITHOUT NOTICE. PROVIDED  
THE FUNCTION AND PERFORMANCE OF  
THE PRODUCT REMAINS REASONABLY  
SIMILAR OR IS IMPROVED.

NOTE: DS\_INSERT LAYER IS A SCALED 1:1 LABEL INSERT OUTLINE

REV.:	DATE: 11/1/2017	BY: G.S.	CHANGES:
-------	-----------------	----------	----------