

RoHS COMPLIANT

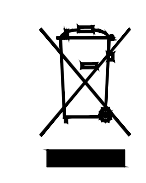

PATCHING SYSTEMS

AUDIO, VIDEO, DATA  
600 WEST ELK AVENUE  
GLENDALE, CA. 91204  
TEL 818 500-8142  
FAX 818 500-7062  
WWW.BITTREE.COM

E90 PIN-OUT

CHANNEL / PR	(RIGHT)	(LEFT)	(SHIELD)	(RST)
1	A	H	R	
2	B	J	S	
3	C	K	T	
4	D	L	U	
5	E	M	V	
6	F	N	W	
7	X	AE	AM	
8	Y	AF	AN	
9	Z	AH	AP	
10	AA	AJ	AR	
11	AB	AK	AS	
12	AC	AL	AT	
13	BJ	BS	BT	
14	BK	BT	BZ	
15	BL	BU	CA	
16	BM	BV	CB	
17	BN	BW	CC	
18	BP	BX	CD	
19	CP	CN	CW	
20	CH	CP	CK	
21	CJ	CR	CY	
22	CK	CS	CZ	
23	CL	CT	DA	
24	CM	CU	DB	
25	AV	AV	DB	
26	AW	BA	BE	

MALE CONNECTOR REAR VIEW  
(CONTACT INSERTION PATTERN)

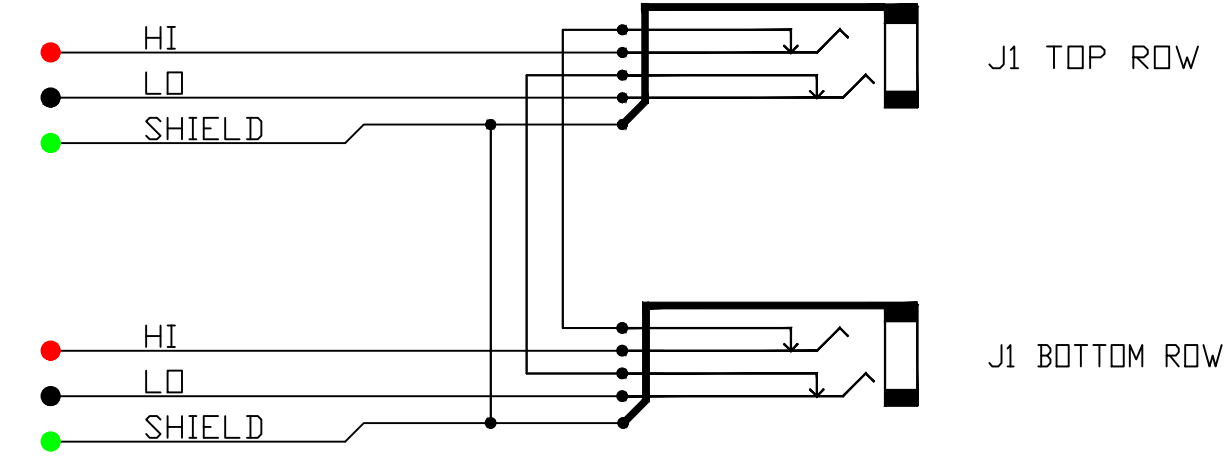
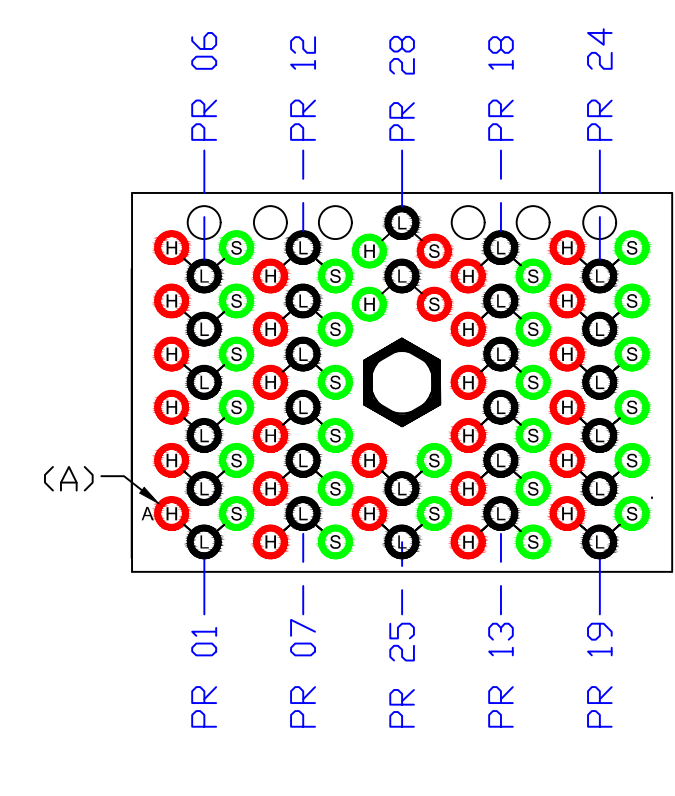

SCHEMATIC  
FULL-NORMALED LOOPED GND VIEW

TOOLS AND ACCESSORIES PART NUMBERS

DESCRIPTION	PART NUMBER
CONTACT CRIMP TOOL	K2MA-01
CONTACT REMOVAL TOOL	S16-280-300
CONTACT INSERTION TOOL	S16-280-400
90 PIN MALE CONNECTOR WITH SCREW	E90MS
90 PIN FEMALE CONNECTOR WITH NUT	E90FN
CONNECTOR CONTACTS (PINS)	EPIN
REPLACEMENT HARDWARE KIT	9690R
PROGRAMMING SHUNTS (RED)	382811-9
PROGRAMMING SHUNTS (WHITE)	382811-0

ELCO/EDAC 90 PIN CONNECTOR

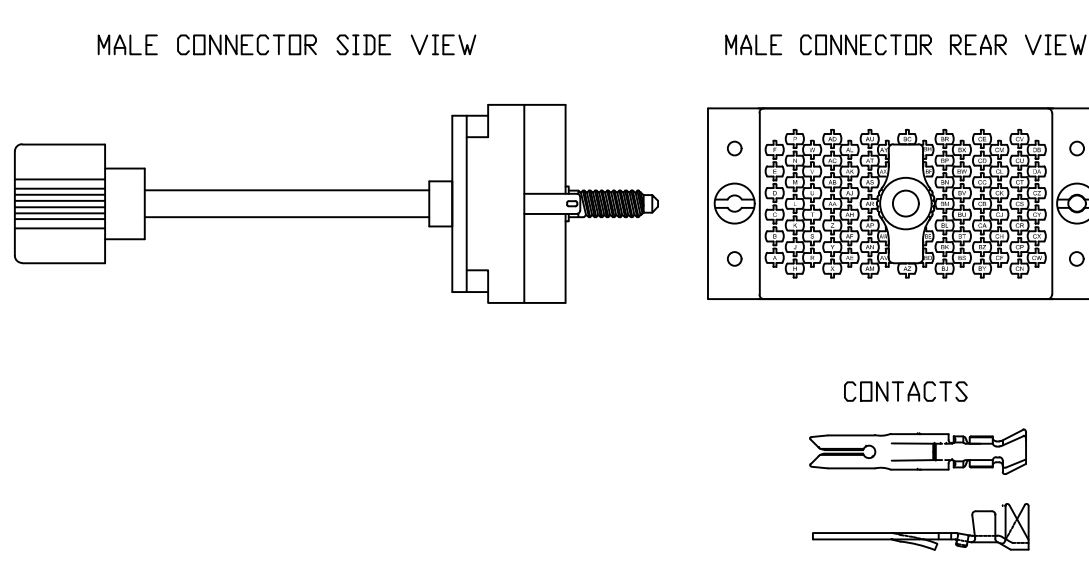

MATING HARDWARE SUPPLIED

FOR PURCHASE OF ADDITIONAL MATING HARDWARE  
SEE ACCESSORIES DRAWING FOR PART NUMBERS.

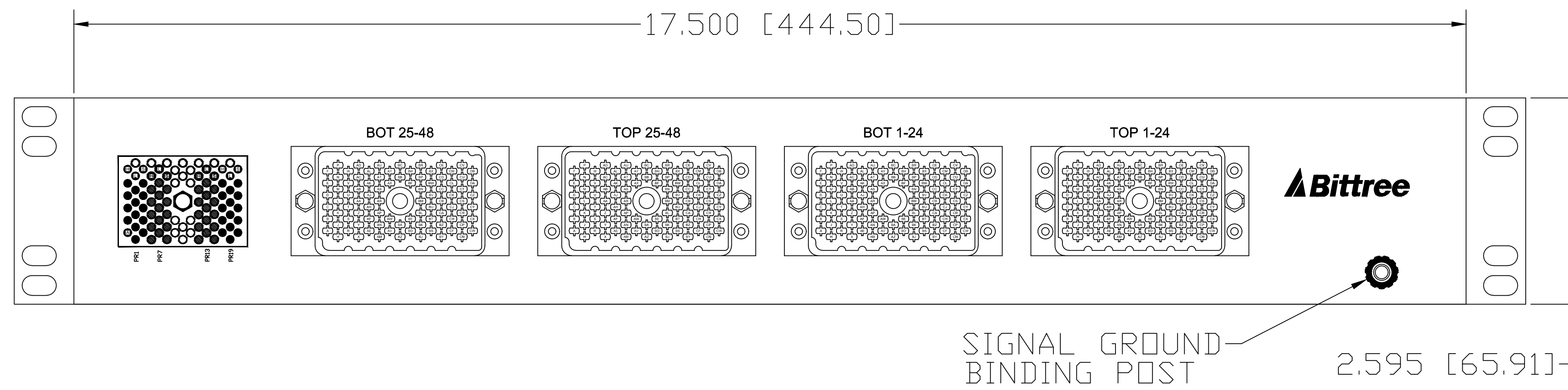

REAR VIEW

DATA CONTAINED IN THIS DOCUMENT  
IS PROPRIETARY AND SHALL NOT BE  
DISCLOSED, COPIED OR USED FOR  
PROCUREMENT OR MANUFACTURE  
WITHOUT EXPRESS WRITTEN PERMISSION  
OF BITTREE INCORPORATED

DWG. NO.:  
B96DCFNILHE90S2DU7B  
PART NO.:  
B96DC-FNILH/E90 S2DU7B  
DESIGNATION: DS800-10-ASSY

E90F CONNECTORS

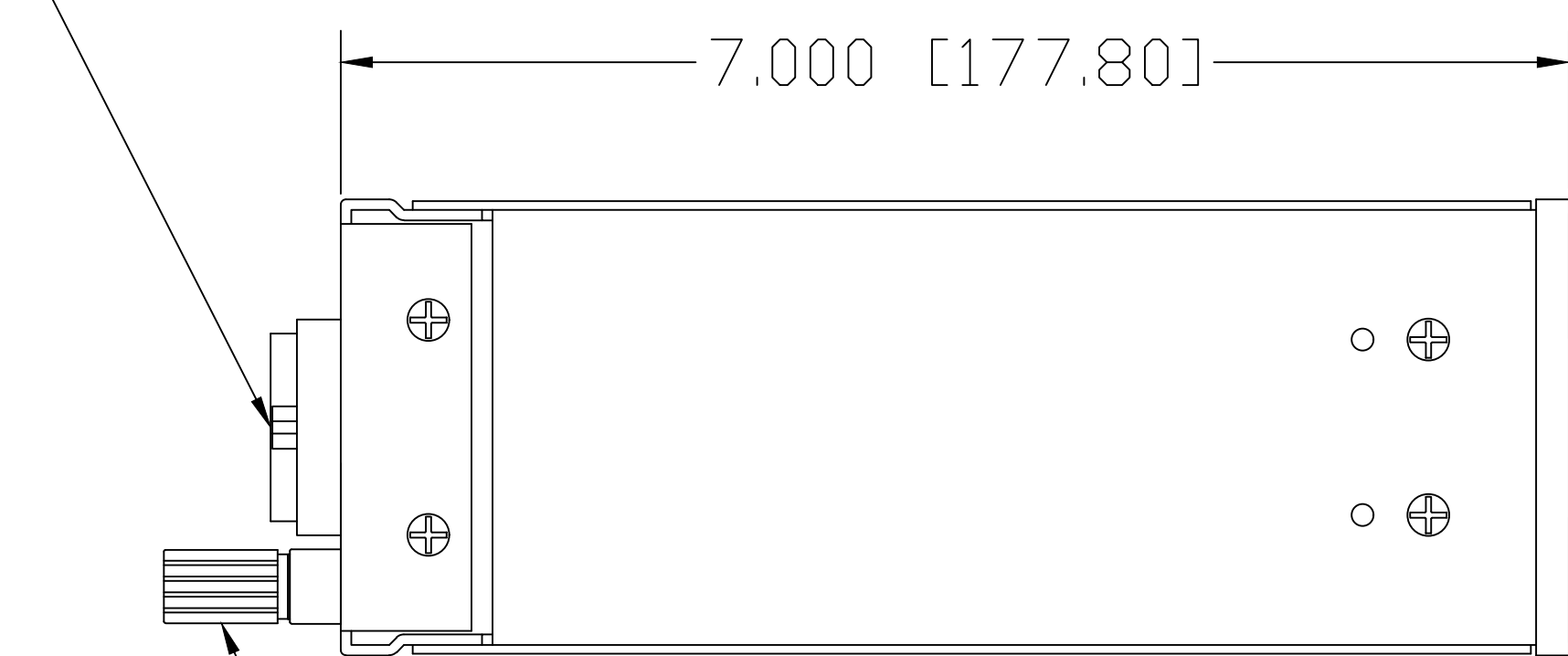

SIGNAL GROUND BINDING POST

LEFT SIDE VIEW

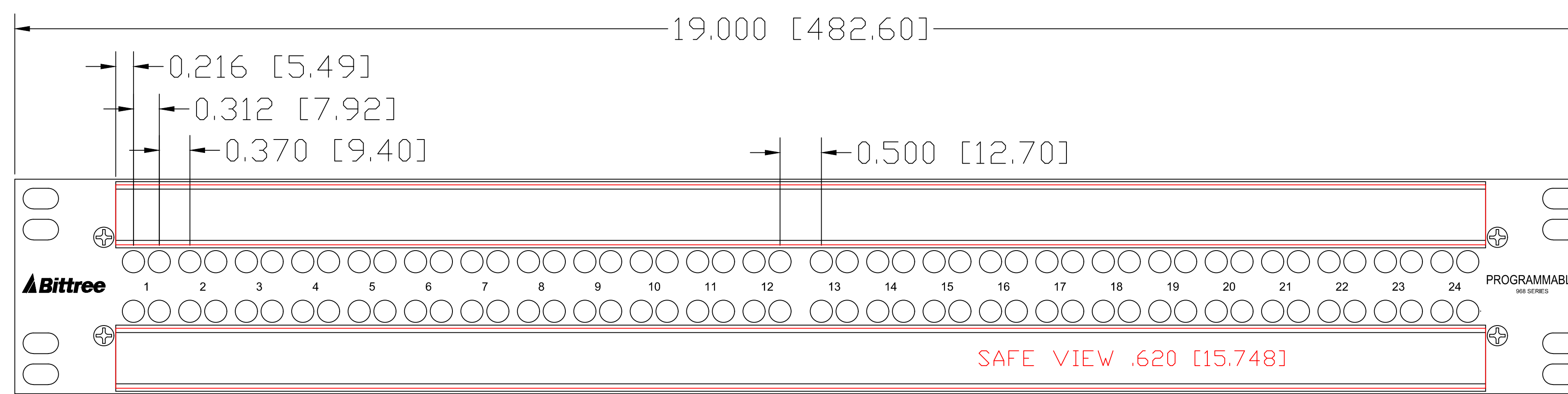

FRONT VIEWS

DESIGNATION:	PART NBR.	DIMENSIONS
STAINLESS STEEL HOLDERS:	DS800-10/S,	.800 [20.320] x 16.560 [420.624]
TRANSLUCENT LEXAN INSERTS:	DS800-10/P,	.725 [18.415] x 16.560 [420.624]
WHITE STYRENE INSERTS:	DS800-10/D,	.725 [18.415] x 16.560 [420.624]

LAYER (DS\_INSERT) IS PROVIDED  
FOR THE CREATION OF LEGEND  
STRIPS FOR THIS PATCHBAY. THE  
RED OUTLINE MATCHES THE SIZE  
OF INSERT.  
PLEASE NOTE THE VIEWABLE AREA  
IS LISTED IN NOTES BELOW THE  
FRONT PANEL VIEW.

DWG. SCALE: FULL

PDF. SCALE: NONE

ALL POSSIBLE CARE HAS BEEN TAKEN IN  
PREPARING THIS SET OF DRAWINGS.  
STATEMENTS AND SPECIFICATIONS ARE  
BELIEVED TRUE BUT CANNOT BE  
GUARANTEED AND THEREFORE WE ARE  
NOT RESPONSIBLE FOR ANY  
INACCURACIES. THIS DOCUMENT SHOULD  
BE USED AS THE BASIS FOR DESIGN OR  
TO ESTABLISH SPECIFICATION LIMITS.

BITTREE RESERVES THE RIGHT TO  
CHANGE OR ALTER SPECIFICATIONS OR  
MATERIALS WITHOUT NOTICE. PROVIDED  
THE FUNCTION AND PERFORMANCE OF  
THE PRODUCT REMAINS REASONABLY  
SIMILAR OR IS IMPROVED.

NOTE: DS\_INSERT LAYER IS A SCALED 1:1 LABEL INSERT OUTLINE

REV.:	DATE: 11/2/2017	BY: G.S.	CHANGES:
-------	-----------------	----------	----------