

RoHS COMPLIANT

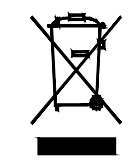

Bittree

PATCHING SYSTEMS

AUDIO, VIDEO, DATA
600 WEST ELK AVENUE
GLENDALE, CA. 91204
TEL 818 500-8142
FAX 818 500-7062
WWW.BITTREE.COM

DATA CONTAINED IN THIS DOCUMENT IS PROPRIETARY AND SHALL NOT BE DISCLOSED, COPIED OR USED FOR PROCUREMENT OR MANUFACTURE WITHOUT EXPRESS WRITTEN PERMISSION OF BITTREE INCORPORATED

DWG. NO.: B96DCFN1LHD25M2DU12B
PART NO.: B96DC-FN1LH/D25 M2DU12B
DESIGNATION: DS800-10-ASSY

DA88 STANDARD CHART FOR DB25 PIN-OUT

PAIR	HI	LO	SH
1	24	12	25
2	10	23	11
3	21	9	22
4	7	20	8
5	18	6	19
6	4	17	5
7	15	3	16
8	1	14	2

DB25 MALE CONNECTOR REAR VIEW

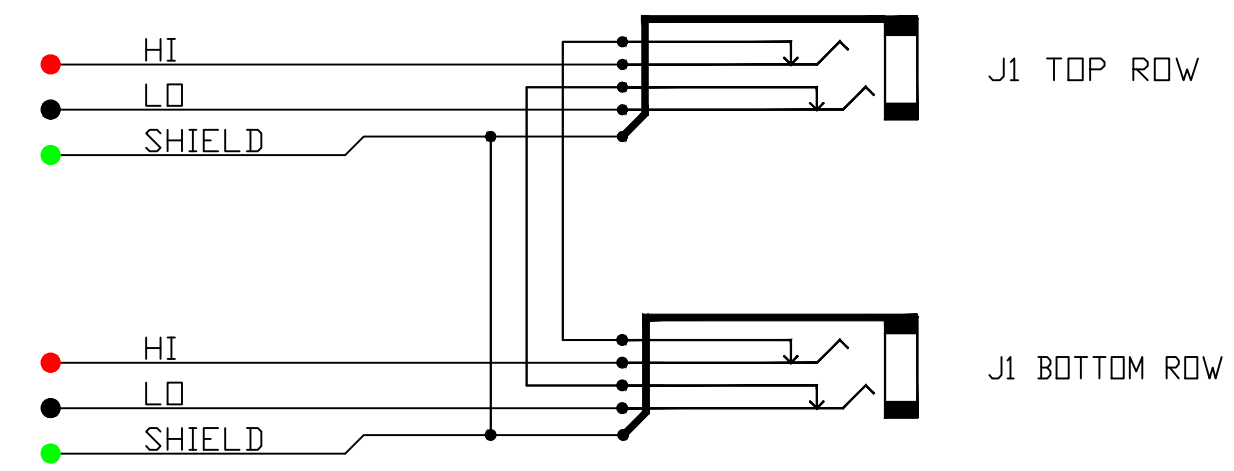
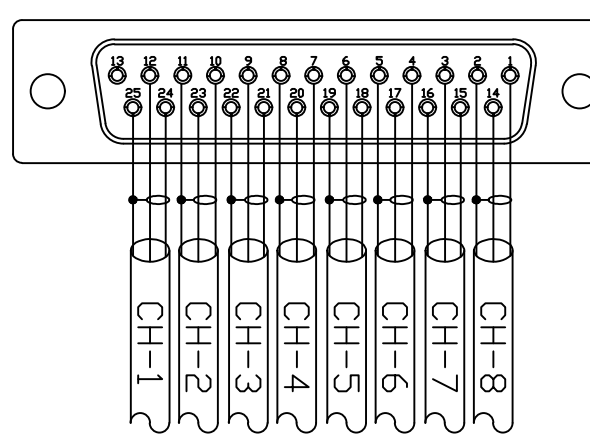

SCHEMATIC FULL-NORMALED LOOPED GND VIEW

TOOLS AND ACCESSORIES PART NUMBERS

DESCRIPTION	PART NUMBER
PROGRAMMING SHUNTS (RED)	382811-9
PROGRAMMING SHUNTS (WHITE)	382811-0
LACING BAR 6IN (152.4MM)	LB-17500
LACING BAR 3IN (76.2MM)	LB175-3
DB25 MALE WITH SOLDER PIN	DS-25P/T
25 PIN DSUB METAL HOOD	DM-25C

DB25M CONNECTOR

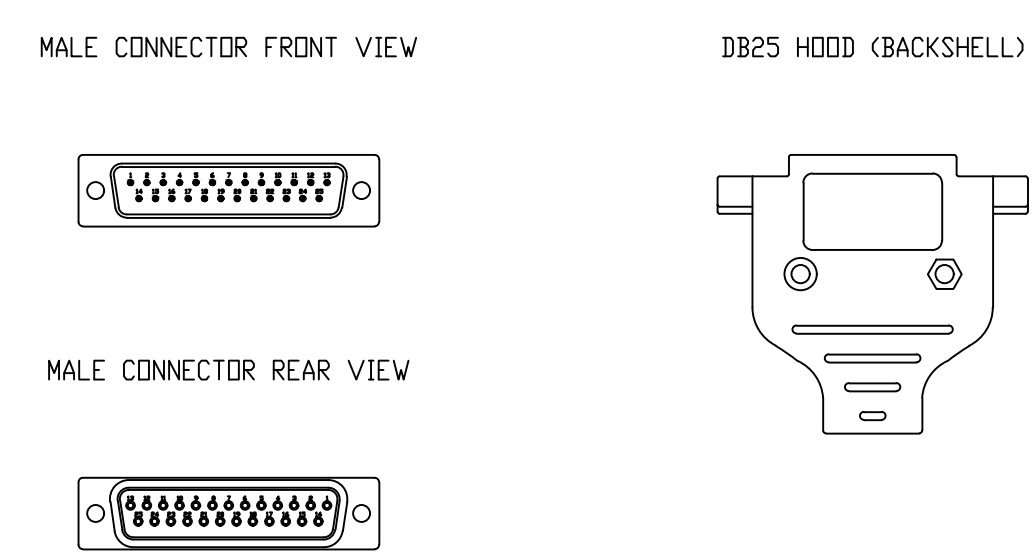

FOR PURCHASE OF MALE DB25M MATING HARDWARE SEE ACCESSORIES DRAWING FOR PART NUMBERS.

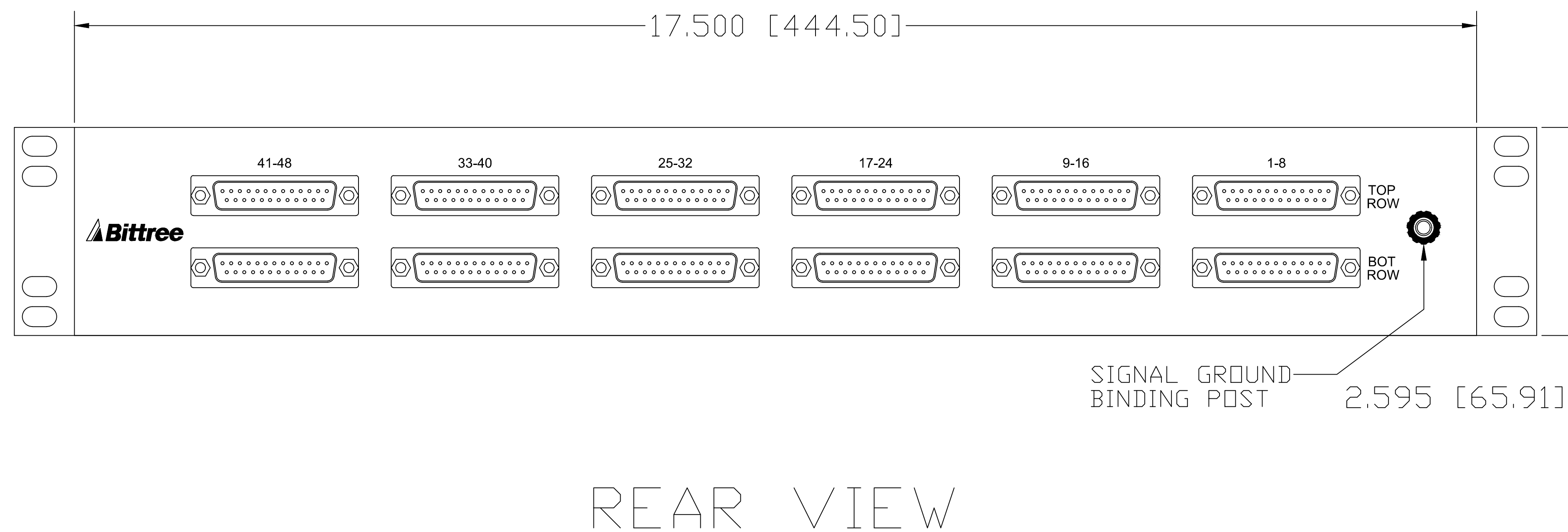

REAR VIEW

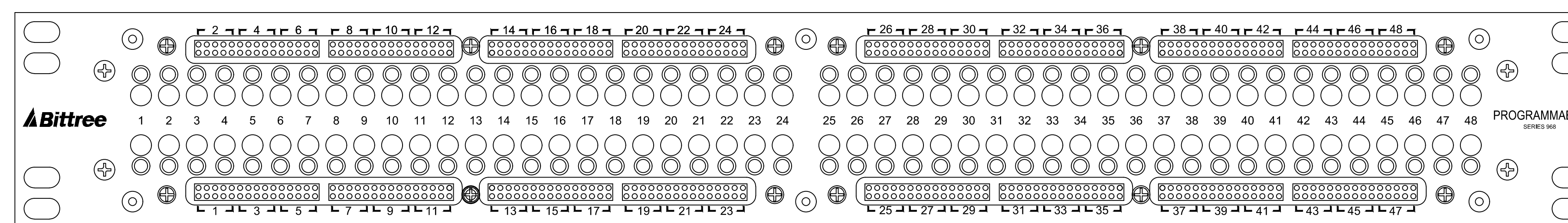

FRONT VIEWS

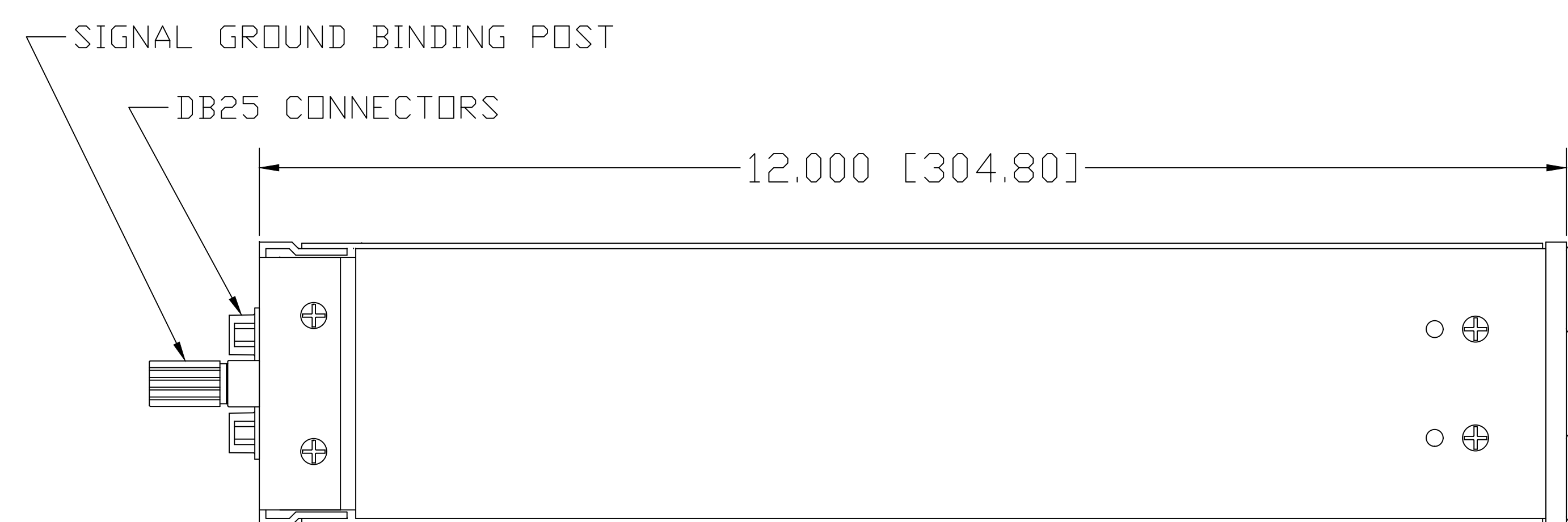

LEFT SIDE VIEW

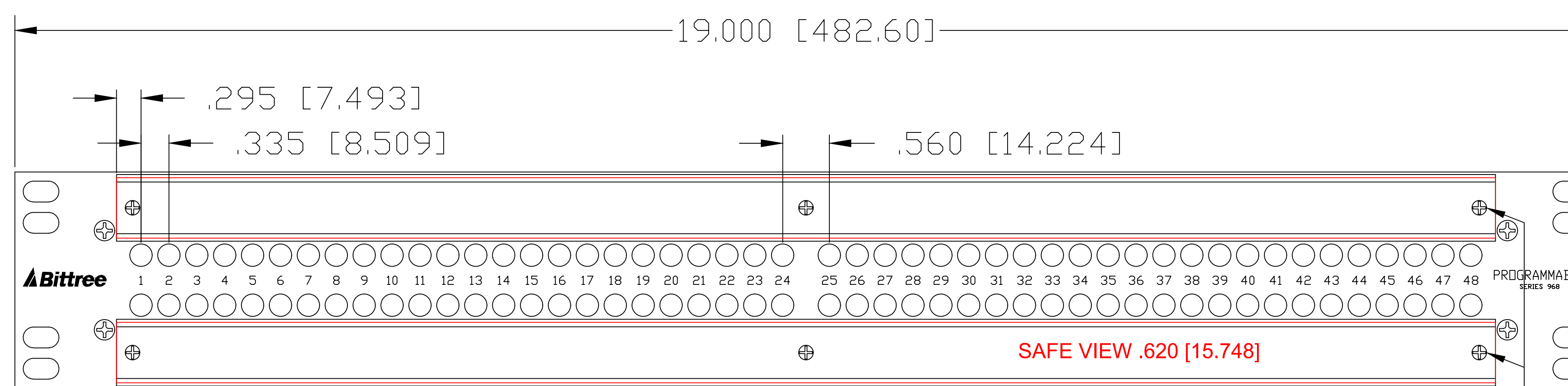

DESIGNATION:	PART NBR.	DIMENSIONS
STAINLESS STEEL HOLDERS:	DS800-10/S,	.800 [20.320] x 16.560 [420.624]
TRANSLUCENT LEXAN INSERTS:	DS800-10/P,	.725 [18.415] x 16.560 [420.624]
WHITE STYRENE INSERTS:	DS800-10/D,	.725 [18.415] x 16.560 [420.624]

REMOVE SCREWS TO ACCESS PROGRAMMING SHUNTS (6X)

LAYER (DS_INSERT) IS PROVIDED FOR THE CREATION OF LEGEND STRIPS FOR THIS PATCHBAY. THE RED OUTLINE MATCHES THE SIZE OF INSERT. PLEASE NOTE THE VIEWABLE AREA IS LISTED IN NOTES BELOW THE FRONT PANEL VIEW.

DWG. SCALE: FULL

PDF. SCALE: NONE

ALL POSSIBLE CARE HAS BEEN TAKEN IN PREPARING THIS SET OF DRAWINGS. STATEMENTS AND SPECIFICATIONS ARE BELIEVED TRUE BUT CANNOT BE GUARANTEED AND THEREFORE WE ARE NOT RESPONSIBLE FOR ANY INACCURACIES. THIS DOCUMENT SHOULD BE USED AS THE BASIS FOR DESIGN OR TO ESTABLISH SPECIFICATION LIMITS.

BITTREE RESERVES THE RIGHT TO CHANGE OR ALTER SPECIFICATIONS OR MATERIALS WITHOUT NOTICE. PROVIDED THE FUNCTION AND PERFORMANCE OF THE PRODUCT REMAINS REASONABLY SIMILAR OR IS IMPROVED.

NOTE: DS_INSERT LAYER IS A SCALED 1:1 LABEL INSERT OUTLINE

REV.:	DATE: 10/20/2017	BY: G.S.	CHANGES:
-------	------------------	----------	----------