



RoHS COMPLIANT



# Bittree

## PATCHING SYSTEMS

AUDIO, VIDEO, DATA  
600 WEST ELK AVENUE  
GLENDALE, CA. 91204  
TEL 818 500-8142  
FAX 818 500-7062  
WWW.BITTREE.COM

### E90 PIN-OUT

CHANNEL	RIGHT	LEFT	SHIELD(S)
1	A	H	R
2	B	J	S
3	C	K	T
4	D	L	U
5	E	M	V
6	F	N	W
7	X	AE	AN
8	Y	AF	AP
9	Z	AH	AP
10	AA	AJ	AS
11	AB	AK	AS
12	AC	AL	AT
13	BJ	BS	BY
14	BK	BT	BA
15	BL	BU	CA
16	BM	BV	CB
17	BN	BW	CC
18	BP	BX	CD
19	CP	CN	CW
20	CH	CP	CY
21	CH	CP	CY
22	CK	CS	CA
23	CL	CT	DA
24	CM	CU	DB
25	AM	AV	EB
26	AW	BA	EC

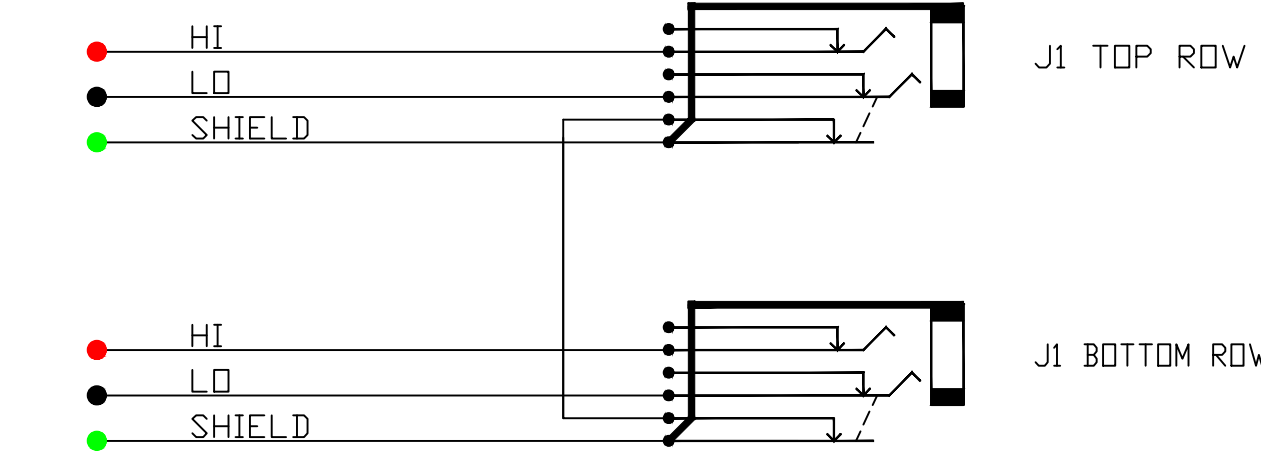
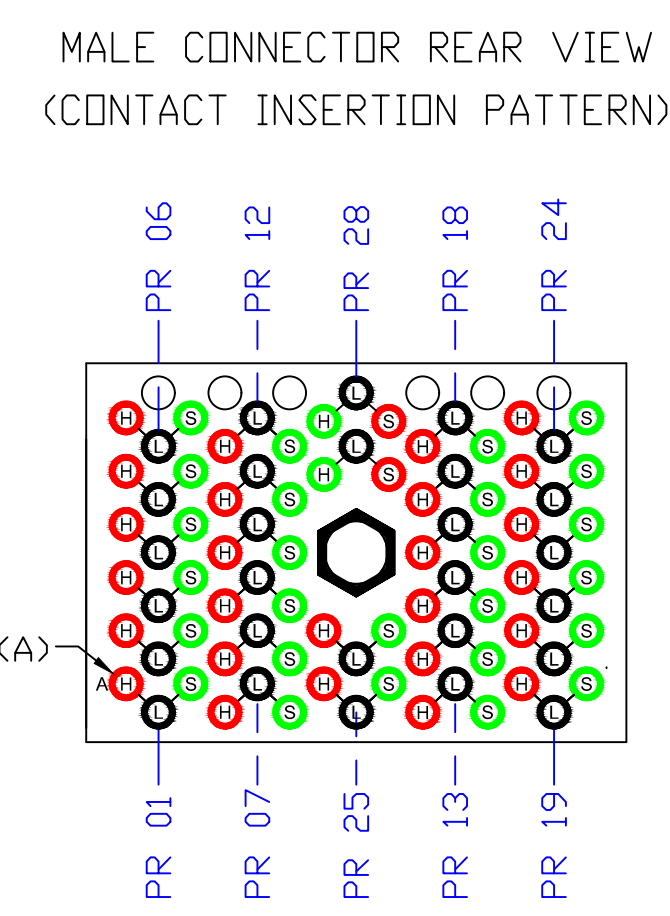

### SCHEMATIC NON-NORMALED SWITCHED GND VIEW

### TOOLS AND ACCESSORIES PART NUMBERS

DESCRIPTION	PART NUMBER
CONTACT CRIMP TOOL	K2MA-01
CONTACT REMOVAL TOOL	516-280-300
CONTACT INSERTION TOOL	516-280-400
90 PIN MALE CONNECTOR WITH SCREW	E90MS
90 PIN FEMALE CONNECTOR WITH NUT	E90FN
CONNECTOR CONTACTS (PINS)	EPIN
REPLACEMENT HARDWARE KIT	9690R
PROGRAMMING SHUNTS (RED)	382811-9
PROGRAMMING SHUNTS (WHITE)	382811-0

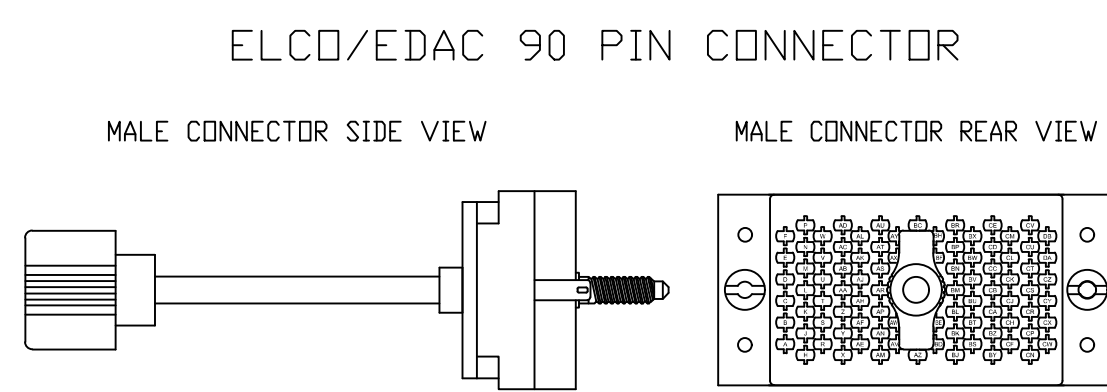

MATING HARDWARE SUPPLIED  
FOR PURCHASE OF ADDITIONAL MATING HARDWARE  
SEE ACCESSORIES DRAWING FOR PART NUMBERS.

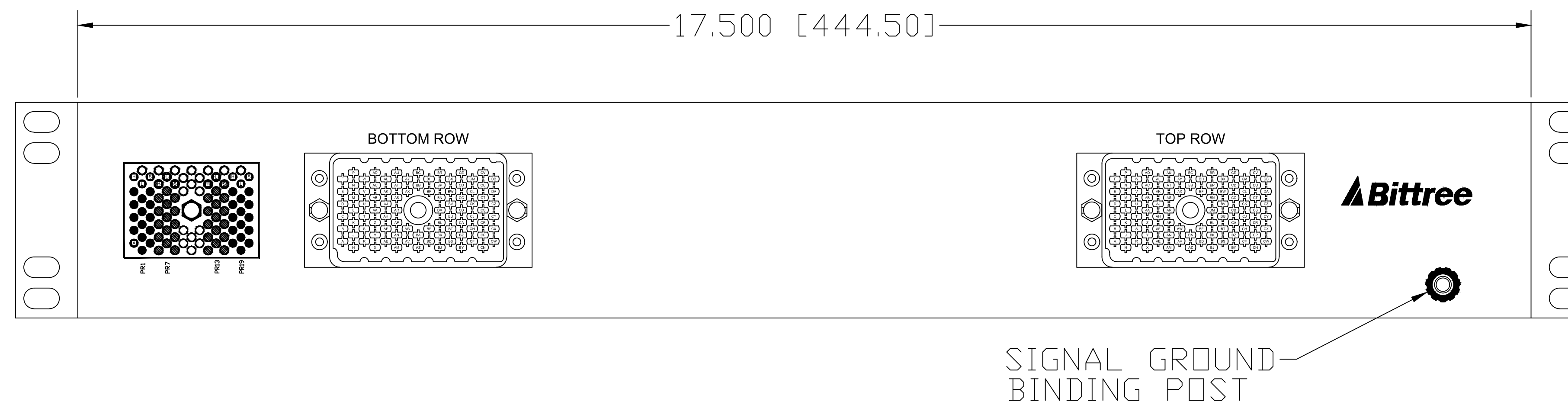

### REAR VIEW

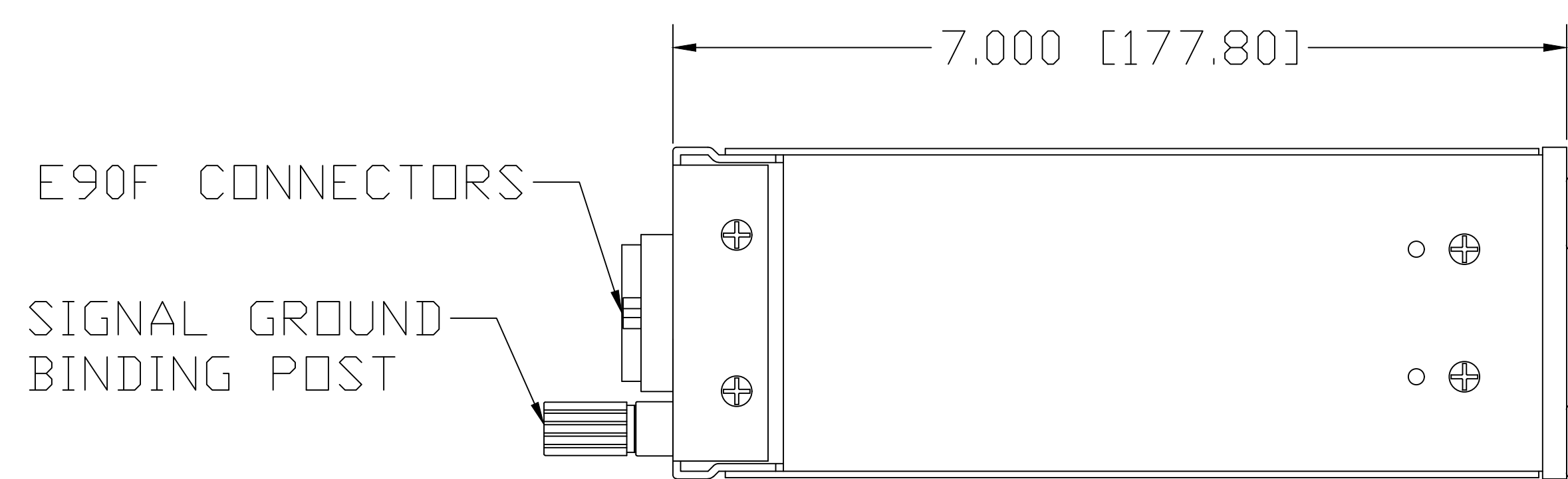
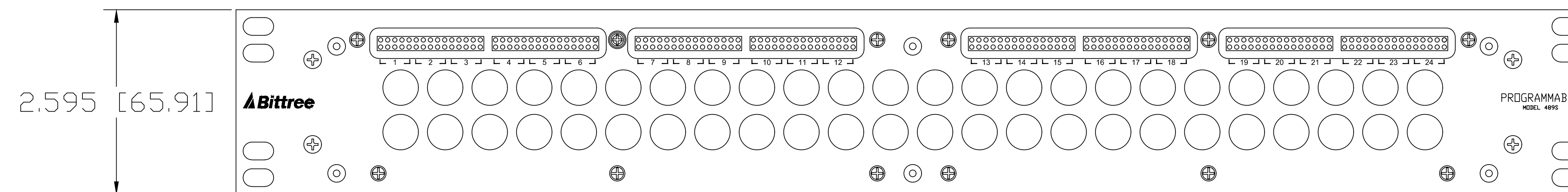

### LEFT SIDE VIEW

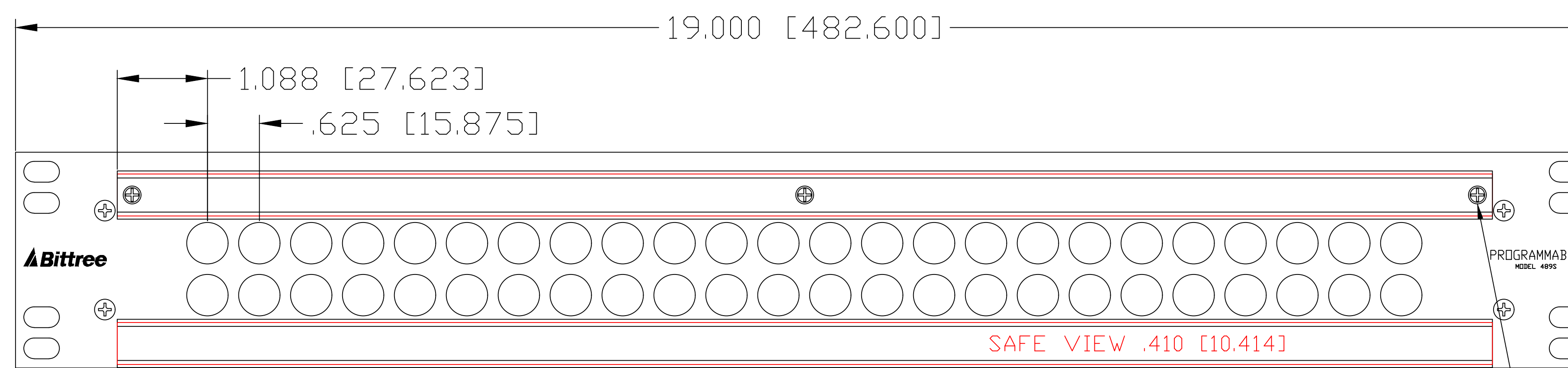

DESIGNATION:	PART NBR.	DIMENSIONS
STAINLESS STEEL HOLDERS:	DS580-10/S,	.580 [14.732] x 16.56 [420.620]
TRANSLUCENT LEXAN INSERTS:	DS580-10/P,	.505 [12.827] x 16.56 [420.624]
WHITE STYRENE INSERTS:	DS580-10/D,	.505 [12.827] x 16.56 [420.624]

REMOVE SCREWS TO ACCESS PROGRAMMING SHUNTS (3X)

### FRONT VIEWS

DATA CONTAINED IN THIS DOCUMENT IS PROPRIETARY AND SHALL NOT BE DISCLOSED, COPIED OR USED FOR PROCUREMENT OR MANUFACTURE WITHOUT EXPRESS WRITTEN PERMISSION OF BITTREE INCORPORATED

DWG. NO.: B48DCNNSSHE90M20U7L

PART NO.: B48DC-NNSSH/E90 M20U7L

DESIGNATION: DS580-10SA-ASSY

LAYER (DS\_INSERT) IS PROVIDED FOR THE CREATION OF LEGEND STRIPS FOR THIS PATCHBAY. THE RED OUTLINE MATCHES THE SIZE OF INSERT. PLEASE NOTE THE VIEWABLE AREA IS LISTED IN NOTES BELOW THE FRONT PANEL VIEW.

DWG. SCALE: FULL

PDF. SCALE: NONE

ALL POSSIBLE CARE HAS BEEN TAKEN IN PREPARING THIS SET OF DRAWINGS. STATEMENTS AND SPECIFICATIONS ARE BELIEVED TRUE BUT CANNOT BE GUARANTEED AND THEREFORE WE ARE NOT RESPONSIBLE FOR ANY INACCURACIES. THIS DOCUMENT SHOULD BE USED AS THE BASIS FOR DESIGN OR TO ESTABLISH SPECIFICATION LIMITS.

BITTREE RESERVES THE RIGHT TO CHANGE OR ALTER SPECIFICATIONS OR MATERIALS WITHOUT NOTICE. PROVIDED THE FUNCTION AND PERFORMANCE OF THE PRODUCT REMAINS REASONABLY SIMILAR OR IS IMPROVED.

NOTE: DS\_INSERT LAYER IS A SCALED 1:1 LABEL INSERT OUTLINE

REV.:	DATE: 11/14/2017	BY: G.S.	CHANGES:
-------	------------------	----------	----------