

RoHS COMPLIANT



Bittree

PATCHING SYSTEMS

AUDIO, VIDEO, DATA
600 WEST ELK AVENUE
GLENDALE, CA. 91204
TEL 818 500-8142
FAX 818 500-7062
WWW.BITTREE.COM

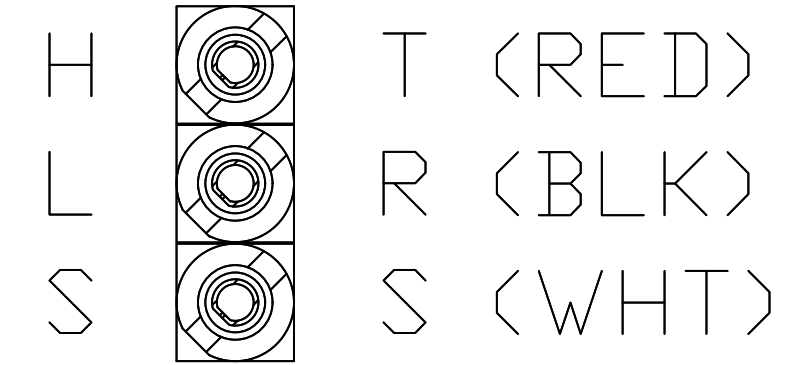

IDC PUNCH DOWN
REAR VIEW PIN-OUT

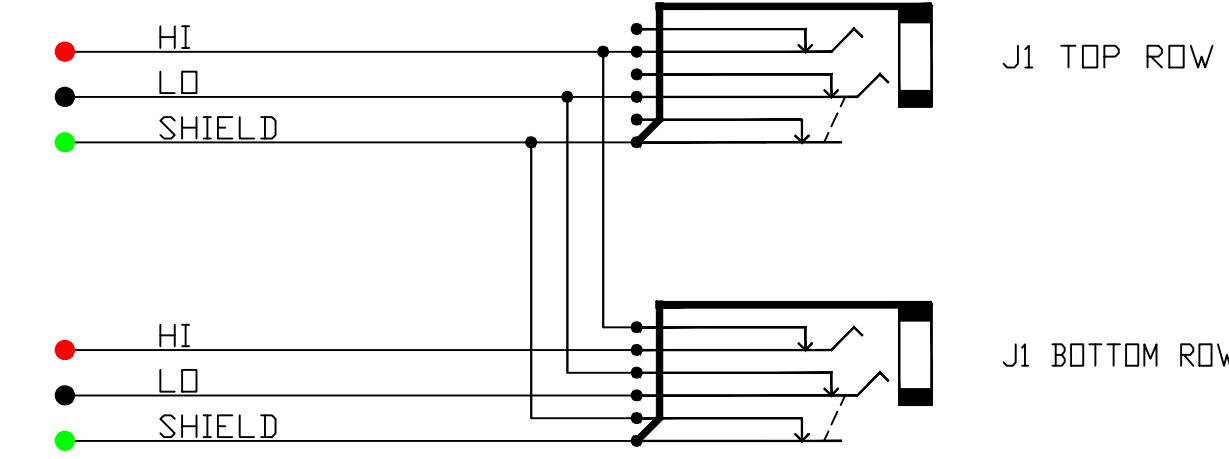

SCHEMATIC
HALF-NORMALIZED SWITCHED GND VIEW

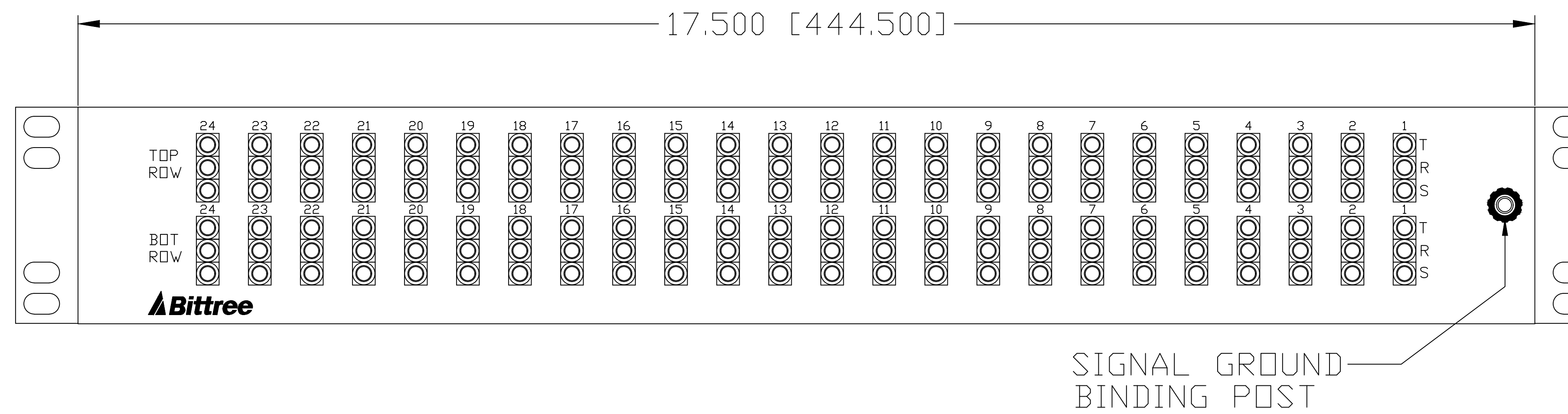

REAR VIEW

TOOLS AND ACCESSORIES PART NUMBERS

DESCRIPTION	PART NUMBER
IMPACT TOOL WITH LIGHT	PT1A
REPLACEMENT IMPACT TOOL TIP	PT2B
THERMOPLASTIC HOUSINGS (BLACK)	K51000
THERMOPLASTIC HOUSINGS (RED)	K51002
THERMOPLASTIC HOUSINGS (WHITE)	K51009
CONNECTOR CONTACTS	K514
PVC TUBING, 2.4 IN (6 CM), BAG OF 100	PTC100
REPLACEMENT HARDWARE KIT	961DR
PROGRAMMING SHUNTS (RED)	382811-9
PROGRAMMING SHUNTS (WHITE)	382811-0
LACING BAR 6IN (152.4MM)	LB-17500
LACING BAR 3IN (76.2MM)	LB175-3

IDC PUNCH DOWN

PLASTIC HOUSINGS: IDC CONTACT: K514

- K51000 (BLACK)
- K51002 (RED)
- K51003 (ORANGE)
- K51004 (YELLOW)
- K51006 (BLUE)
- K51009 (WHITE)

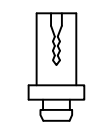

REPAIR HARDWARE KIT SUPPLIED

FOR PURCHASE OF ADDITIONAL MATING HARDWARE SEE ACCESSORIES DRAWING OR USE ABOVE PART NUMBERS

DATA CONTAINED IN THIS DOCUMENT IS PROPRIETARY AND SHALL NOT BE DISCLOSED, COPIED OR USED FOR PROCUREMENT OR MANUFACTURE WITHOUT EXPRESS WRITTEN PERMISSION OF BITTREE INCORPORATED

DWG. NO.: B48DCHNSSHIDM20U12L

PART NO.: B48DC-HNSSH/ID M20U12L

DESIGNATION: DS580-10SA-ASSY

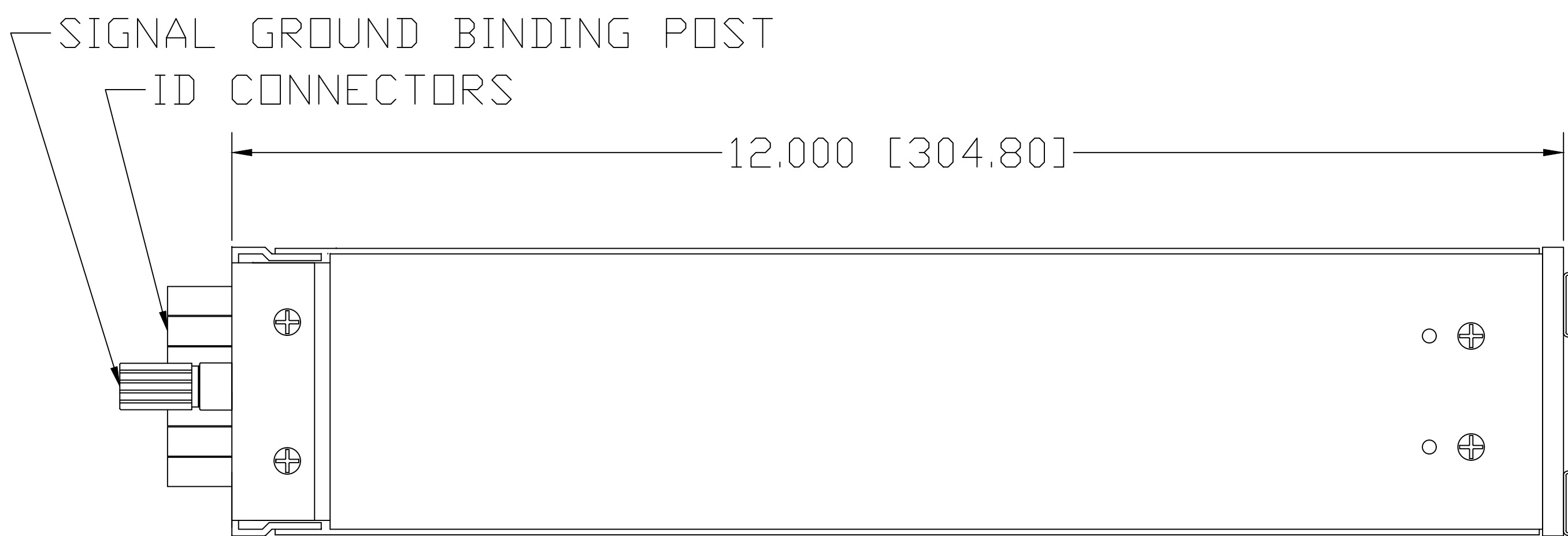
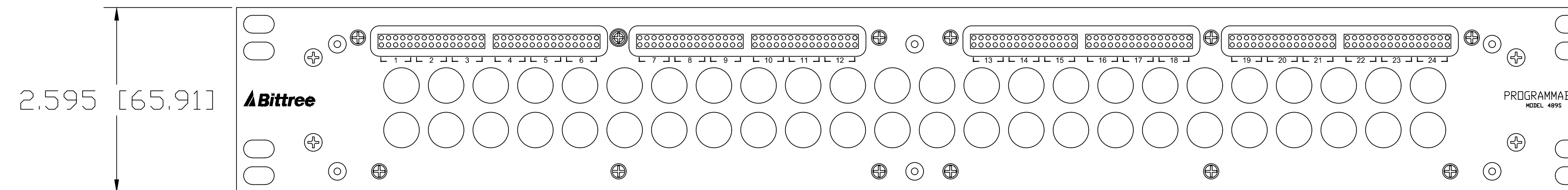

LEFT SIDE VIEW

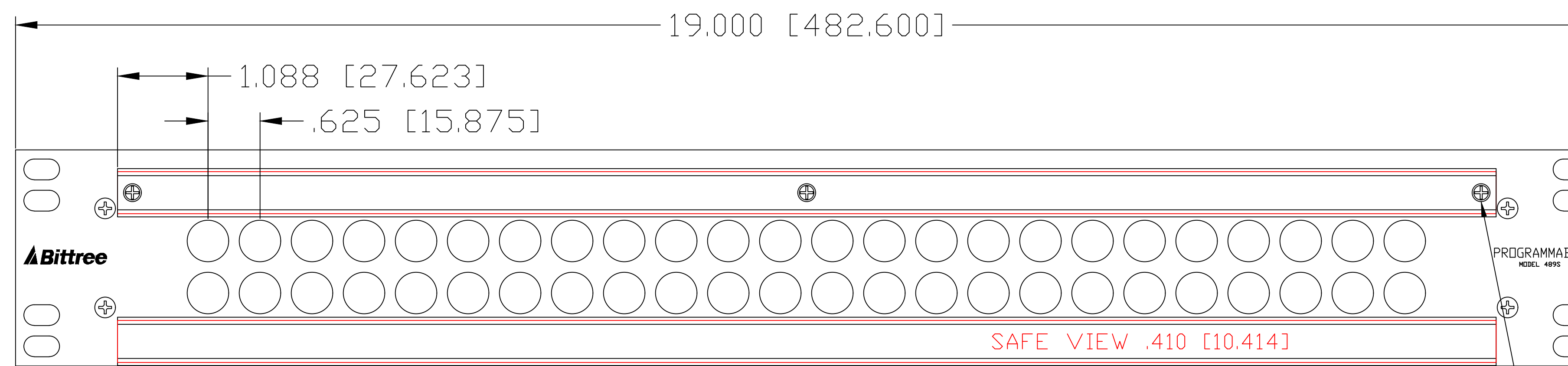

FRONT VIEWS

DESIGNATION:	PART NBR.	DIMENSIONS
STAINLESS STEEL HOLDERS:	DS580-10/S,	.580 [14.732] x 16.56 [420.620]
TRANSLUCENT LEXAN INSERTS:	DS580-10/P,	.505 [12.827] x 16.56 [420.624]
WHITE STYRENE INSERTS:	DS580-10/D,	.505 [12.827] x 16.56 [420.624]

REMOVE SCREWS TO ACCESS PROGRAMMING SHUNTS (3X)

LAYER (DS_INSERT) IS PROVIDED FOR THE CREATION OF LEGEND STRIPS FOR THIS PATCHBAY. THE RED OUTLINE MATCHES THE SIZE OF INSERT. PLEASE NOTE THE VIEWABLE AREA IS LISTED IN NOTES BELOW THE FRONT PANEL VIEW.

DWG. SCALE: FULL

PDF. SCALE: NONE

ALL POSSIBLE CARE HAS BEEN TAKEN IN PREPARING THIS SET OF DRAWINGS. STATEMENTS AND SPECIFICATIONS ARE BELIEVED TRUE BUT CANNOT BE GUARANTEED AND THEREFORE WE ARE NOT RESPONSIBLE FOR ANY INACCURACIES. THIS DOCUMENT SHOULD BE USED AS THE BASIS FOR DESIGN OR TO ESTABLISH SPECIFICATION LIMITS.

BITTREE RESERVES THE RIGHT TO CHANGE OR ALTER SPECIFICATIONS OR MATERIALS WITHOUT NOTICE. PROVIDED THE FUNCTION AND PERFORMANCE OF THE PRODUCT REMAINS REASONABLY SIMILAR OR IS IMPROVED.

NOTE: DS_INSERT LAYER IS A SCALED 1:1 LABEL INSERT OUTLINE

REV.:	DATE: 11/14/2017	BY: G.S.	CHANGES:
-------	------------------	----------	----------