



# BERLIN GARDENS

STRUCTURES COLLECTION 2023

SINCE 1988 | MADE IN THE USA

# Living our values.

At Berlin Gardens, our first goal is to bring honor and glory to our creator, God, in everything we do.

We do this by manufacturing the highest quality products, delivering our products on time and going beyond your expectations with our customer service.

All of this starts by living by our Core Values of honesty, efficiency, attitude, respect and trust.

We not only say this, but we believe it.

We hope our products help you *take life outdoors*<sup>™</sup>.

— The Yoder Family

## Contents

### PERGOLAS

Urbana Vinyl Pergola	6
Outback Wood Pergola	8
Mendoza Wood Pergola	10
Vineyard Wood Pergola	12
Alcove Wood Pergola	14
Vinyl Pergola Gallery	16
Wood Pergola Gallery	18
Design a Vinyl Pergola	20
Design a Wood Pergola	21

### PAVILIONS

Victoria Vinyl Pavilion	22
Wellington Composite Pavilion	24
Hampton Wood Pavilion	26
Cascade Wood Pavilion	28
Breckenridge Wood Pavilion	30
Mesa Wood Pavilion	32
Prairie Wood Pavilion	34
Norwood Wood Pavilion	36
Vinyl + Composite Pavilion Gallery	38
Wood Pavilion Gallery	40
Design a Vinyl or Composite Pavilion	42
Design a Wood Pavilion	44
Miscellaneous Gallery	46
Fabric Options	48
Dia Shade	49
Curtains	50
Privacy Wall	51

# The options are endless.



**It's your choice,  
make it your own.**

An outdoor sanctuary. A quiet respite. A new place to gather with family and friends.

A structure from Berlin Gardens can transform your landscape into the haven you've been pining for. From open concepts to decorative touches, there's a structure that suits your tastes and standards.

*(Shown above): Standard Cascade*

## Classic, carefree vinyl

Durable and beautiful, vinyl requires very little attention. Regular cleaning with a mild dish detergent or similar product is normally all that's needed to keep your structure looking its best.

- Contains 50% recycled material
- Made in the U.S.A.
- Won't crack, fade or chalk
- Easy to assemble — or we'll assemble if you prefer

## Natural, beautiful wood

Clear-grade, treated lumber helps protect your structure from the elements. Our structures are made from hand-selected Southern Yellow Pine.

- Pressure-treated to resist decay
- Air-dried after treatment for enhanced durability
- Harvested in the U.S.A.
- Milled to exact specifications
- Please refer to in-person samples for an accurate color
- All wood posts are laminated to limit warping; laminations are visible
- Manufactured in kit form



### Compare our structures:

	Pergola	Pavilion
Full shade / protection from rain		●
Partial shade	●	
Curtains	●	●
Privacy walls	●	●
Dia shade	●	
Customizable	●	●
Structurally engineered	●	●
Manufactured in kit form	●	●

### See how our materials stack up:

	Vinyl	Wood	Composite
Ease of cleaning	●	●	●
Durable	●	●	●
Highest quality material possible	●	●	●
Low maintenance	●		●
Paintable / Stainable (color customizable)		●	●
Made in the U.S.A.	●	●	●

## Protect your investment

Like all lumber products exposed to the elements, your wooden structure will weather over time. Eventually, you will notice splits, cracks or checks — separations in the wood caused by changes in moisture content. This is perfectly natural. In fact, many feel it adds to the character of a structure.

### So let nature do its work.

To keep your structure looking beautiful for years to come, just use the provided stain to protect exposed wood in new cracks and splits.

# Urbana

**STANDARD MODEL INCLUDES:**

- White vinyl
- 6" X 6" posts
- Scrolled or classic end caps
- Pressure treated wood inserts in posts, beams, and purlins



The Urbana Vinyl Pergola complements your home with its classic styling and crisp, clean lines.



## Specifications | Urbana Vinyl Pergola

*Please Note: Urbana Pergolas with sides of 22' and above will require additional posts.*

Size	10'	12'	14'	16'	20'	24'
A (Outside to outside of top)	10'	12'	14'	16'	20'	24'
B (Center to center of posts)	82"	106"	130"	154"	202"	250"
C	Overall Height is 103"					
D	Distance from bottom of post to bottom of beam is 88"					
E (Post base size)	6" X 6" Square Post: 9" X 9" 8" X 8" Square Post/Savannah Post: 11¼" X 11¼" Round Post: 13" X 13"					

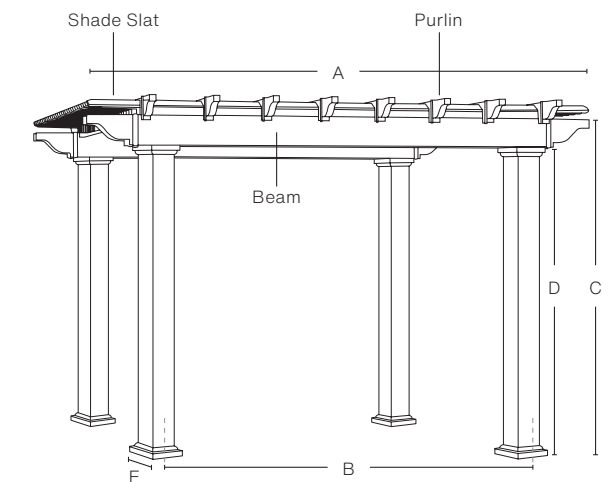

# Outback

**STANDARD MODEL INCLUDES:**

- 6" X 6" laminated, pressure treated wood posts
- Scrolled or classic end cuts
- 2" X 6" purlins and 2" X 2" shade slats
- Pressure treated wood purlins notched onto the beams for added stability



(Shown above): 8" X 8" posts; Cedartone stain

The casual look of the Outback Pergola fits seamlessly into your space, inviting you outside.



Attached to house; Dia shade; Arched braces

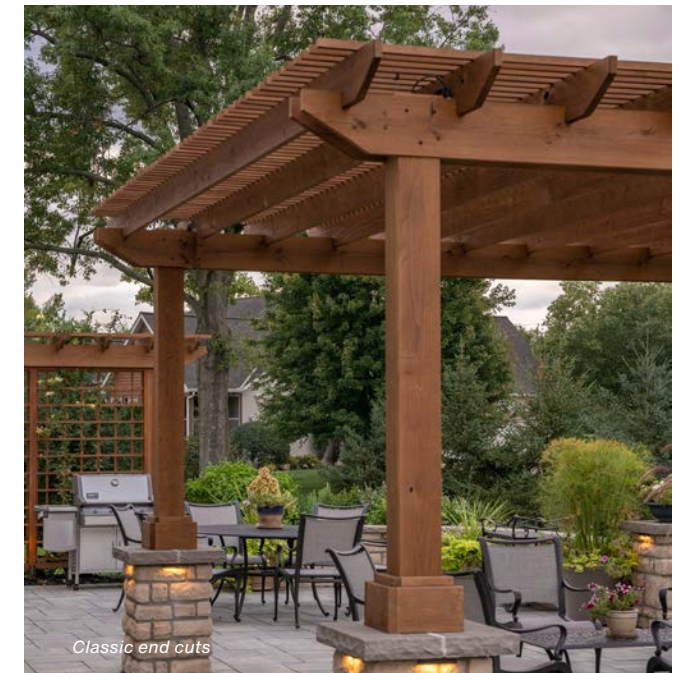

Classic end cuts

## Specifications | Outback Wood Pergola

Please Note: Outback Pergolas with sides of 22' and above will require additional posts.

Size	10'	12'	14'	16'	20'	24'
A (Outside to outside of top)	10'	12'	14'	16'	20'	24'
B (Center to center of posts)	82 <sup>3</sup> / <sub>4</sub> "	106 <sup>3</sup> / <sub>4</sub> "	130 <sup>3</sup> / <sub>4</sub> "	154 <sup>3</sup> / <sub>4</sub> "	204 <sup>3</sup> / <sub>4</sub> "	250 <sup>3</sup> / <sub>4</sub> "
C	Overall Height is 101"					
D	Distance from bottom of post to bottom of beam is 87"					
E (Post base size)	6" X 6" Square Post: 10 <sup>1</sup> / <sub>2</sub> " X 10 <sup>1</sup> / <sub>2</sub> " 8" X 8" Square Post: 12 <sup>1</sup> / <sub>2</sub> " X 12 <sup>1</sup> / <sub>2</sub> "					

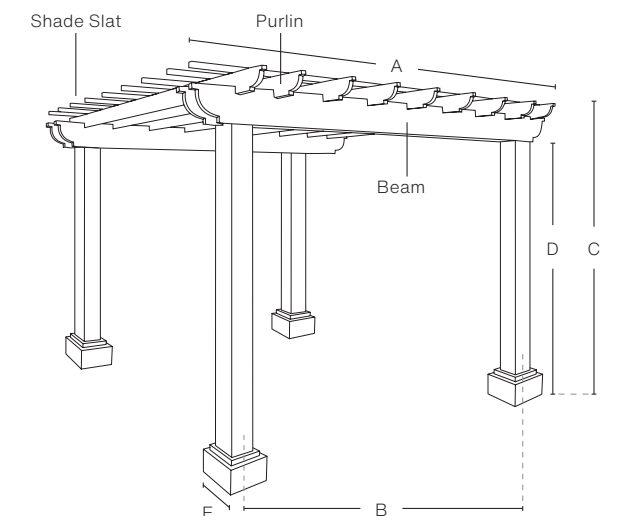

# Mendoza



**STANDARD MODEL INCLUDES:**  
 6" X 6" laminated, pressure treated wood posts  
 Scrolled or classic end cuts  
 2" X 8" purlins  
 Pressure treated wood purlins notched onto the beams for added stability

(Shown above): Dia shade

Embracing the great outdoors, the Mendoza top is open and airy.



8" X 8" posts



Savannah posts; Curtains

## Specifications | Mendoza Wood Pergola

Please Note: Mendoza Pergolas with sides of 22' and above will require additional posts.

Size	10'	12'	14'	16'	20'	24'
A (Outside to outside of top)	10'	12'	14'	16'	20'	24'
B (Center to center of posts)	82¾"	106¾"	130¾"	154¾"	204¾"	250¾"
C	Overall Height is 101"					
D	Distance from bottom of post to bottom of beam is 87"					
E (Post base size)	6" X 6" Square Post: 10½" X 10½" 8" X 8" Square Post: 12½" X 12½"					

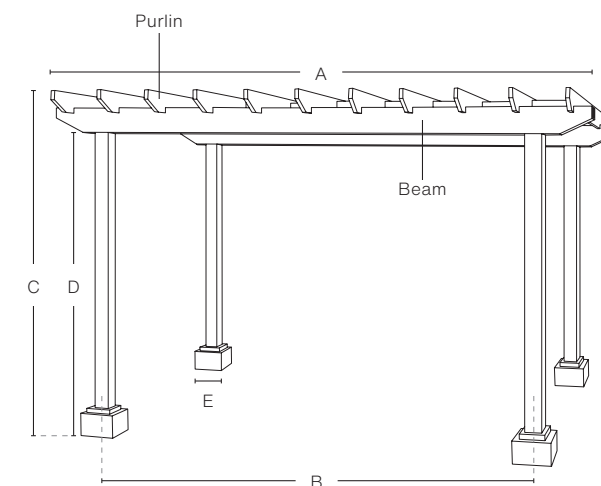

# Vineyard



**STANDARD MODEL INCLUDES:**

- 8" X 8" laminated, pressure treated wood posts
- Pressure treated wood beams notched onto the posts for added stability
- Modern checkered top design

(Shown above): Shade slats

The Vineyard Pergola allows for the perfect windswept draft. The rectangular model and flat top encourage a contemporary look for any space.



Half lattice

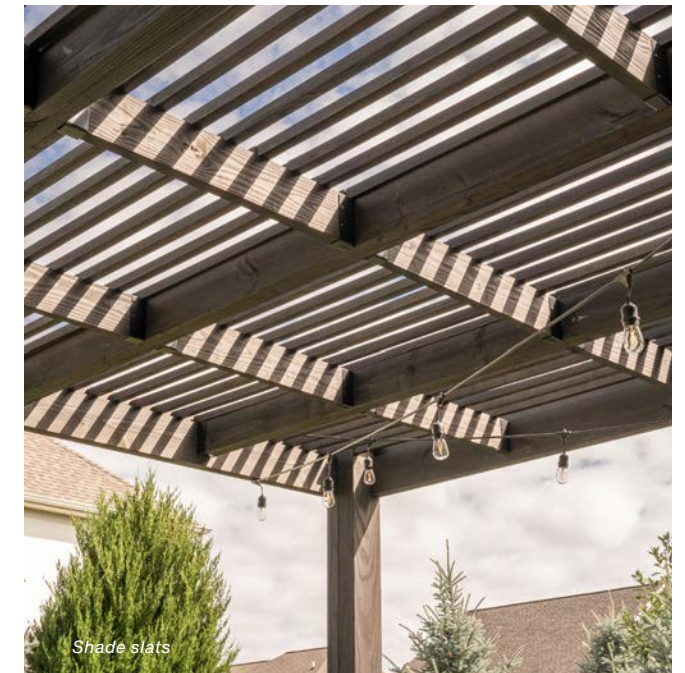

Shade slats

## Specifications | Vineyard Wood Pergola

Please Note: Vineyard Pergolas with sides of 20' and above will require additional posts.

Size	10'	12'	14'	16'	18'	20'	24'
A (Outside to outside of top)	10'	12'	14'	16'	18'	20'	24'
B (Center to center of posts)	113"	137"	161"	185"	209"	233"	281"
C	Overall Height is 98" (varies with width)						
D	Distance from bottom of post to bottom of beam is 89"						
E (Post base size)	12½" X 12½"						

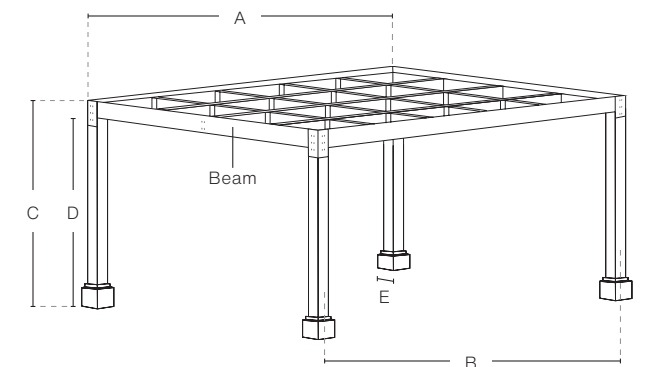

# Alcove

**STANDARD MODEL INCLUDES:**

- 6" X 6" posts
- Scrolled end cuts
- 2" X 6" purlins
- 2" X 2" shade slats



Create an inviting visual backdrop with the Alcove.



*Shown with privacy walls*

### Specifications | Alcove Wood Pergola

*Please Note: Alcove is only available in 8', 10' and 12'.*

Size	8'	10'	12'
A (Outside to outside of top)	140"	174"	205"
B (Center to center of posts)	66¾"	90¾"	114¾"
C (Diagonal distance center to center of posts)	94"	128"	162"
D	Overall Height is 102½"		
E	Distance from bottom of post to bottom of beam is 87"		
F (Post base size)	6" X 6" Square Post: 10½" X 10½"		

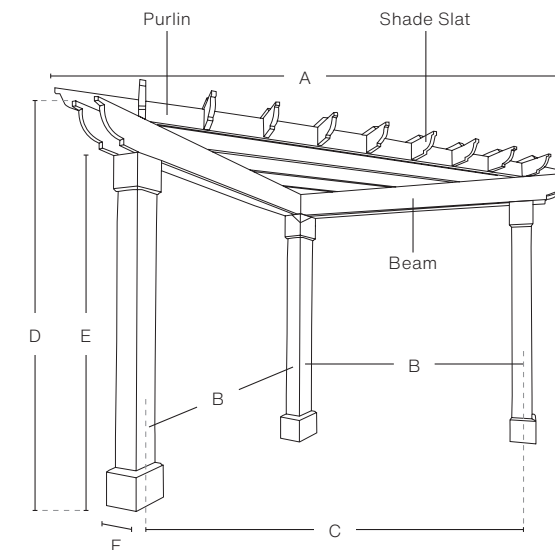





(Shown above): Regular shade; 8" X 8" posts; Straight braces; Attached to the house





(Shown above): Standard Outback with custom lattice walls/panels



# Design a Vinyl Pergola in 6 easy steps:

## 1 Choose a size.

### Things to consider:

- How much space do you have available?
- Berlin Gardens measurements are based on the TOP dimensions, not the "footprint" of the posts. The posts are set in 16" from the outside edge of the purlins and beams.

### Sizes (outside to outside of top)

Widths (purlins) available: 10', 12', 14', 16', 18'\*

Lengths (beams) available: 10', 12', 14', 16', 18', 20', 22', 24'

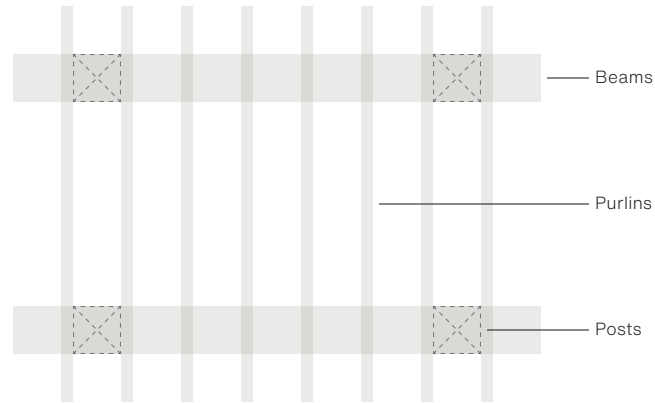

Beams and purlins extend 16" past post positions. Pergolas 22' and above will have 6 posts. Length must be equal or greater than the width. \*18' width is not available with deluxe shade.

## 2 Choose a site type.

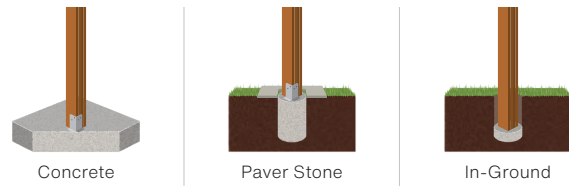

\*Concrete footer should be installed prior to structure.

## 3 Choose a shade style.

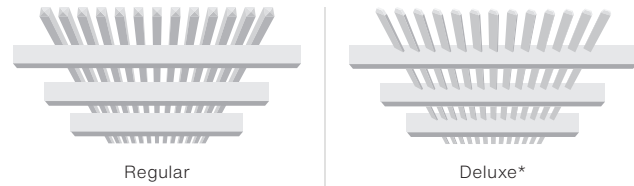

\*18' width is not available with deluxe shade.

## 4 Choose a post style.

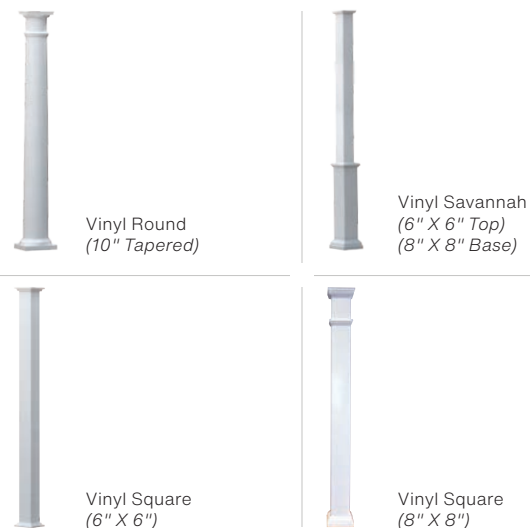

## 5 Choose an end cap.

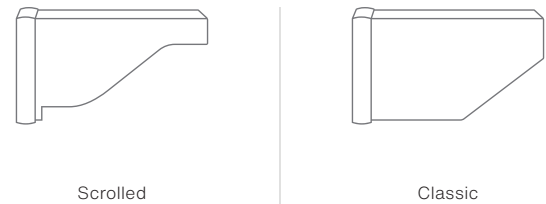

## 6 Choose a color.



# Design a Wood Pergola in 7 easy steps:

## 1 Choose a size.

### Things to consider:

- How much space do you have available?
- Berlin Gardens measurements are based on the TOP dimensions, not the "footprint" of the posts. The posts are set in 16" from the outside edge of the purlins and beams.

### Sizes (outside to outside of top)

Widths (purlins) available: 10', 12', 14', 16', 18'

Lengths (beams) available: 10', 12', 14', 16', 18', 20', 22', 24'

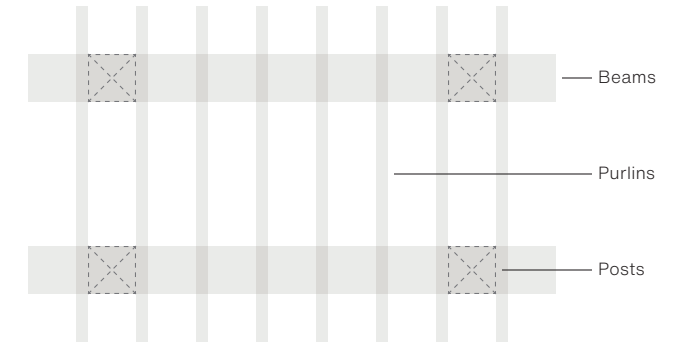

Beams and purlins extend 16" past post positions on all pergolas except Vineyard. Vineyard beams and purlins extend 1.5" past post. Pergolas 22' and above will have 6 posts. Length must be equal or greater than the width.

## 2 Choose a style.

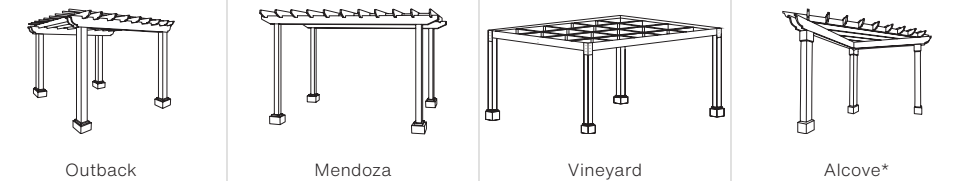

\*Alcove is only available in 8', 10' and 12'.

## 3 Choose a site type.

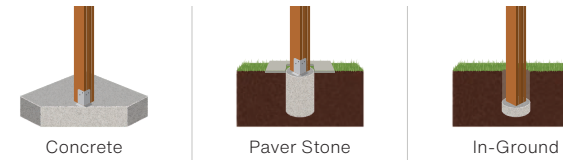

\*Concrete footer should be installed prior to structure.

## 4 Choose a vineyard shade.

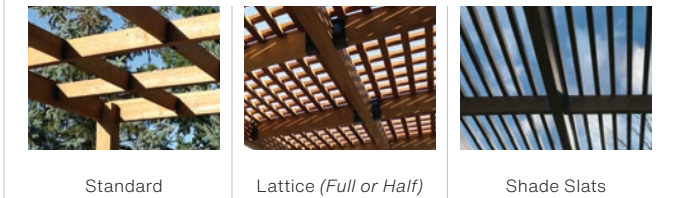

## 5 Choose a post style.

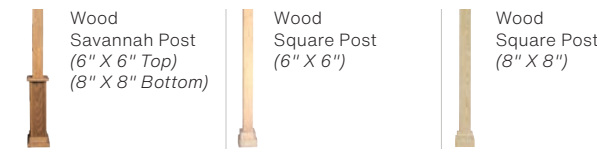

\*Vineyard is only offered with an 8" X 8" wood square post.

## 6 Choose an end cap.

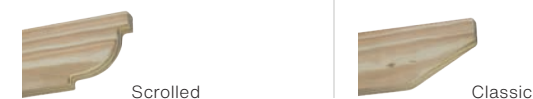

## 7 Choose a color.



\*Please refer to in-person samples for an accurate color.

# Victoria

**STANDARD MODEL INCLUDES:**

- 8" X 8" square posts
- Straight or arched beams (beams are wrapped with cellular PVC trim)
- Painted rafters with exposed pine sheathing (clear sealer on sheathing)



Inspired by the graceful architecture of Victorian England, this pavilion is the perfect spot for relaxing in royal style.



Clay with arched beams; Round tapered columns with curtains



Premiere arch with a Classic roof

## Specifications | Victoria Vinyl Pavilion

Please Note: Victoria Pavilions with sides of 20' and above will require additional posts.

Size	10'	12'	14'	16'	18'	20'	24'
A	139"	163"	187"	211"	235"	259"	307"
B (Center to center of posts)	114"	138"	162"	186"	210"	234"	282"
C (Regular roof)	130"	136"	142"	148"	154"	160"	172"
C (Classic roof)	147"	153"	159"	165"	171"	177"	189"
D	Distance from bottom of post to bottom of beam is 84"						
E (Post base size)	Round Column: 13" X 13" 8" X 8" Square: 11¼" X 11¼"						

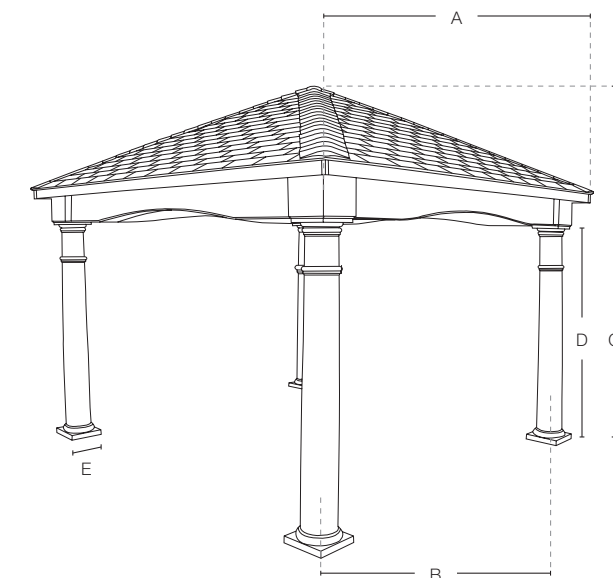

# Wellington

Refined style —  
natural beauty.

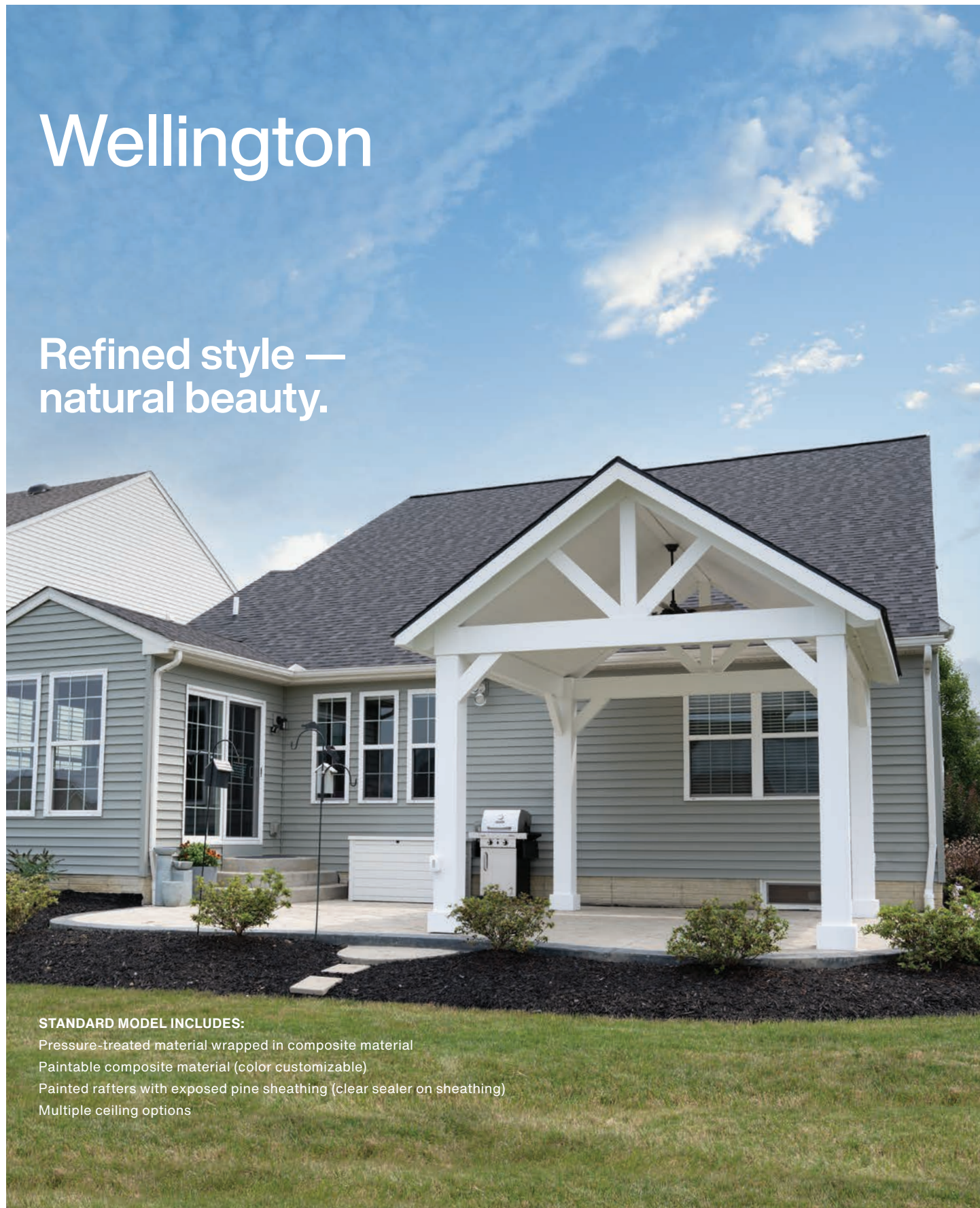

**STANDARD MODEL INCLUDES:**

- Pressure-treated material wrapped in composite material
- Paintable composite material (color customizable)
- Painted rafters with exposed pine sheathing (clear sealer on sheathing)
- Multiple ceiling options

With clean lines and trend-setting aesthetics, the Wellington adds a low-maintenance yet stylish touch to your backyard retreat.



Windsor One ceiling

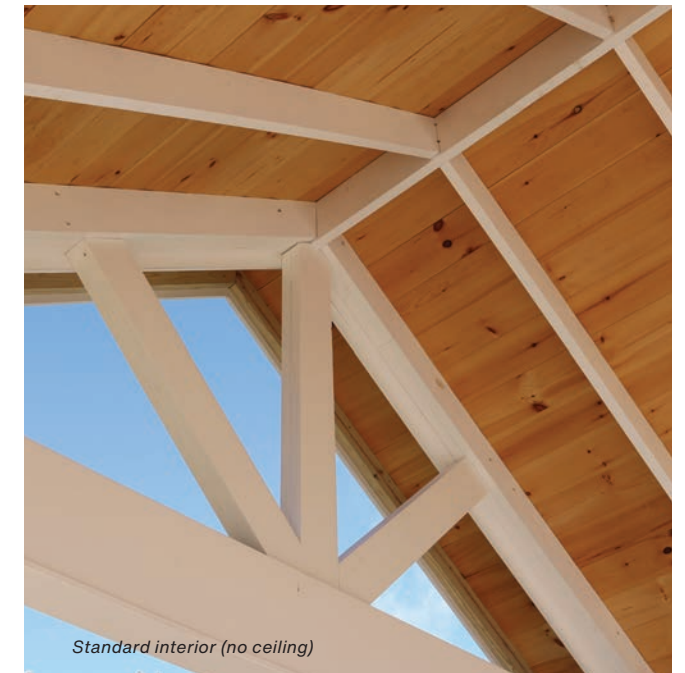

Standard interior (no ceiling)

### Specifications | Wellington Composite Pavilion

Please Note: Wellington Pavilions with sides of 20' and above will require additional posts.

Size	10'	12'	14'	16'	18'	20'	24'
A (Outside to outside of top)	12"	14"	16"	18"	20"	22"	26"
B (Center to center of posts)	111"	135"	159"	183"	207"	231"	279"
C (Overall height)	144"	152"	160"	168"	176"	183"	200"
D	Distance from bottom of post to bottom of beam is 87"						
E	Distance from bottom of post to top of beam is 96"						

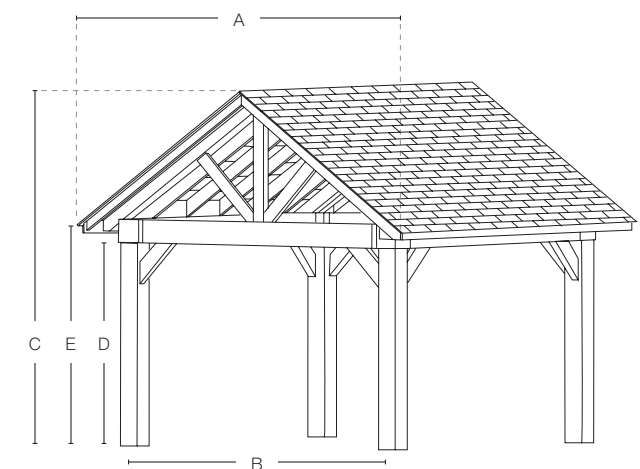

# Hampton

**STANDARD MODEL INCLUDES:**

- Hampton posts
- Arched or straight beams
- 6" overhang
- No notched post and beam joint
- Exposed pine sheathing (ceiling not available)
- Not customizable



Reminiscent of the architecture found throughout the Long Island seaside retreat, the Hampton is a timeless addition to your landscape.



6" X 6" posts



Classic roof

## Specifications | Hampton Wood Pavilion

Please Note: Hampton Pavilions with sides of 20' and above will require additional posts.

Size	10'	12'	14'	16'	20'
A	127"	151"	175"	199"	247"
B (Center to center of posts)	113¼"	137¼"	161¼"	185¼"	233¼"
C (Regular roof)	130"	136"	142"	148"	N/A
C (Classic roof)	147"	153"	159"	165"	N/A
D	Distance from bottom of post to bottom of beam is 87"				
E	Distance from bottom of post to top of beam is 96"				
E (Post base size)	6" X 6" Square: 10½" X 10½" 8" X 8" Square: 12½" X 12½" Hampton Style: 12½" X 12½"				

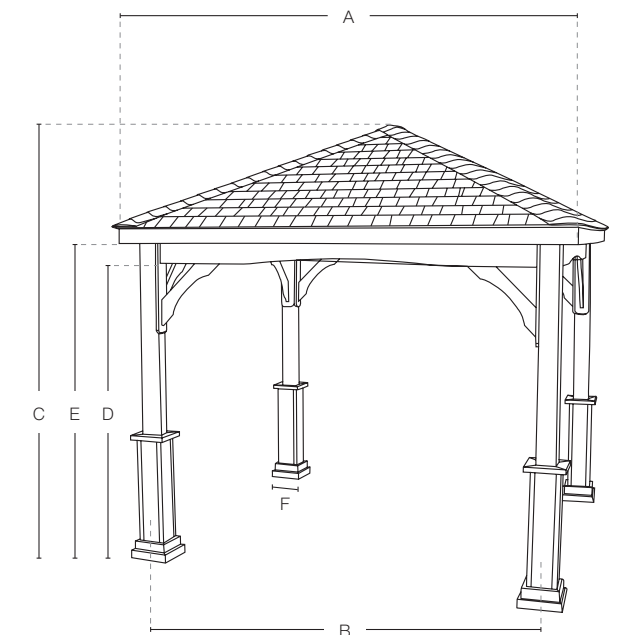

# Cascade

**STANDARD MODEL INCLUDES:**

- 8" X 8" posts
- Straight beams
- Straight or arched braces
- Notched post and beam joint
- Hip roof design
- 11" overhang



Form meets function in this beautifully constructed pavilion — a perfect backdrop for your next gathering.



Specifications | Cascade Wood Pavilion

Please Note: Cascade Pavilions with sides of 20' and above will require additional posts.

Size	10'	12'	14'	16'	18'	20'	24'
A (Outside to outside of roof)	139"	163"	187"	211"	235"	259"	307"
B (Center to center of posts)	111"	135"	159"	183"	207"	231"	279"
C (Regular roof)	133"	139"	145"	151"	157"	163"	175"
C (Classic roof)	150"	156"	162"	168"	174"	180"	192"
D	Distance from bottom of post to bottom of beam is 87"						
E	Distance from bottom of post to top of beam is 96"						
F (Post base size)	8" X 8" Square: 12½" X 12½"						

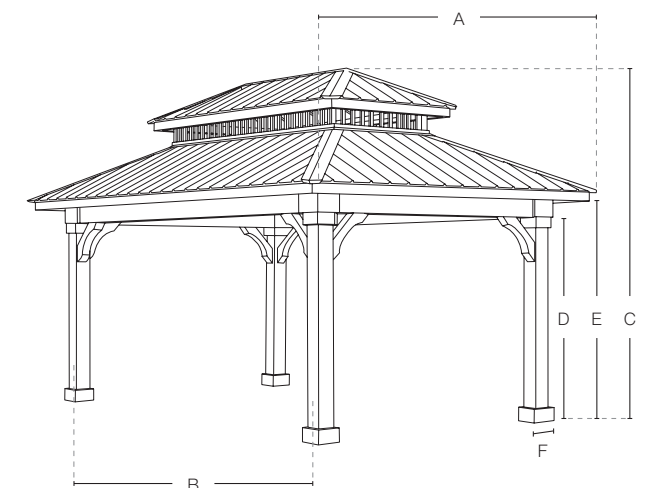

# Breckenridge

**STANDARD MODEL INCLUDES:**

- 8" X 8" posts
- Straight beams
- Straight or arched braces
- Notched post and beam joint
- Gable roof design
- 12" overhang
- Made with optional ceiling



With its open gable trusses, this pavilion maximizes the benefits of being outdoors while keeping you under shelter.

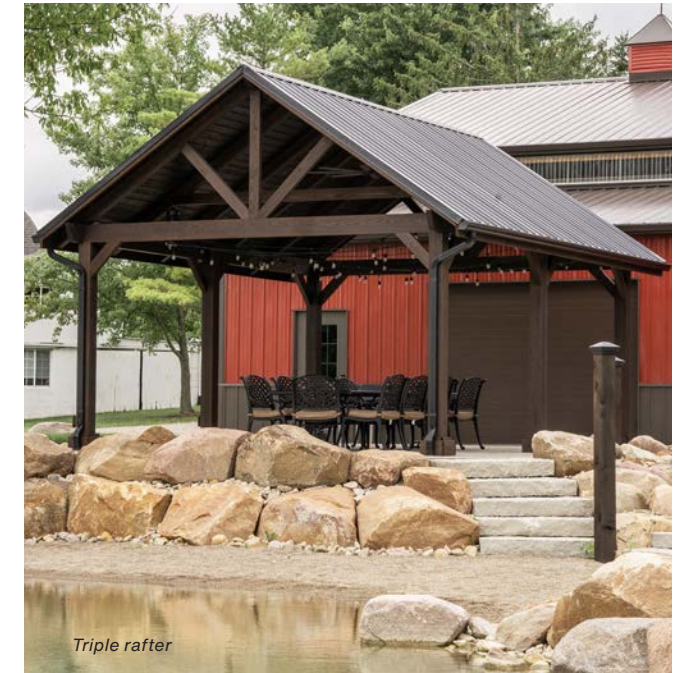

## Specifications | Breckenridge Wood Pavilion

*Please Note: Breckenridge Pavilions with sides of 20' and above will require additional posts.*

Size	10'	12'	14'	16'	18'	20'	24'
A (Outside to outside of roof)	144"	168"	192"	216"	240"	264"	312"
B (Center to center of posts)	113"	137"	161"	185"	209"	233"	281"
C (Regular roof)	144"	152"	160"	168"	176"	183"	200"
D	Distance from bottom of post to bottom of beam is 87"						
E	Distance from bottom of post to top of beam is 96"						
F (Post base size)	8" X 8" Square: 12½" X 12½"						

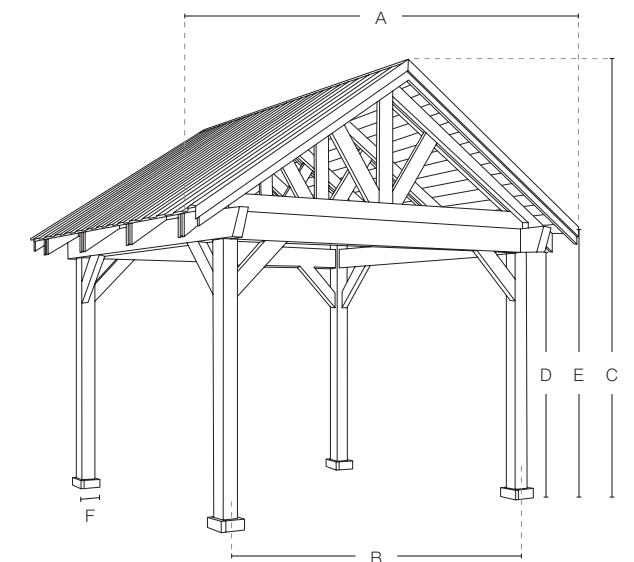



# Mesa

**STANDARD MODEL INCLUDES:**

- Western red cedar timbers
- Solid cedar 8" X 8" posts (no wire chase)
- 4" X 10" beams — 4" X 6" rafters
- 2" X 6" tongue-and-groove pine sheathing
- 12" eave overhang
- 16" gable overhang



An instant focal point to your backyard. Constructed with stout and mighty timber with a gable roof design, it's a spacious structure for any gathering — or a leisurely afternoon.



Standard interior

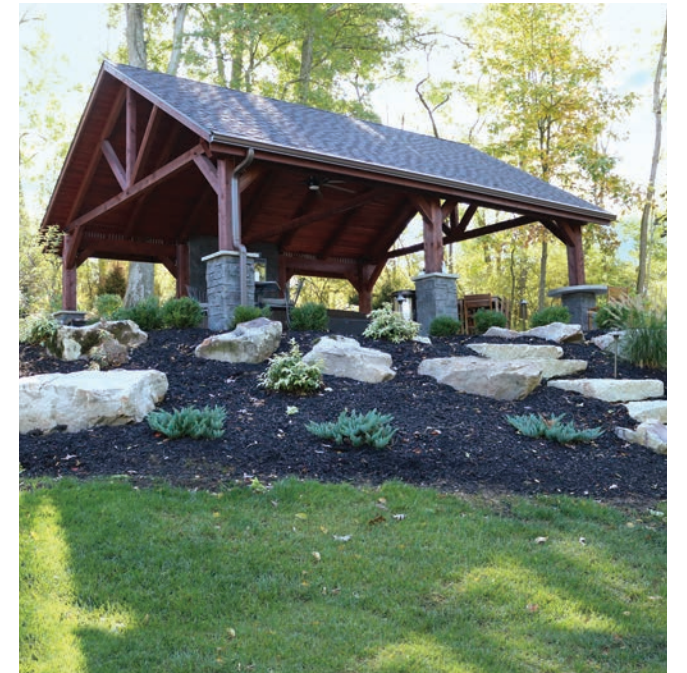

Specifications | Mesa Wood Pavilion

Please Note: Mesa Pavilions with sides of 20' and above will require additional posts.

Size	10'	12'	14'	16'	18'	20'	24'
A (Outside to outside of roof)	12'	14'	16'	18'	20'	22'	26'
B (Center to center of posts)	112"	136"	160"	184"	208"	232"	280"
C (Overall height)	144"	152"	160"	168"	176"	183"	200"
D	Distance from bottom of post to bottom of beam is 86"						
E	Distance from bottom of post to top of beam is 96"						

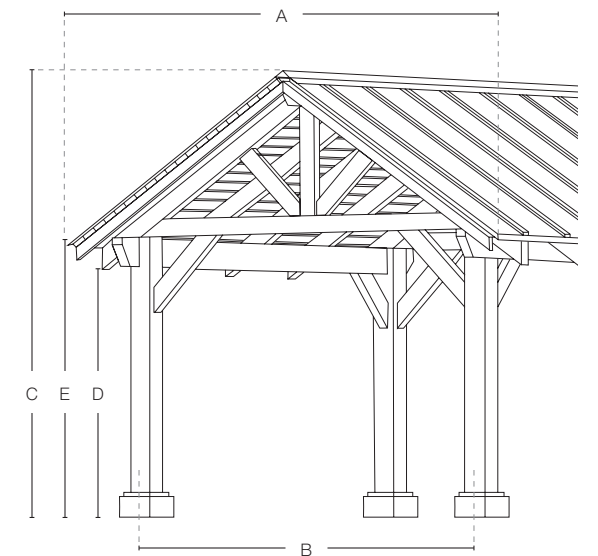

# Prairie



**STANDARD MODEL INCLUDES:**

- 8" X 8" posts
- Straight, three-ply beam
- Straight braces
- Slant roof design
- Notched post and beam joint

The Prairie appeals to minimalistic styles with its distinctive lines and classic shed roof.



Open Eave roof; Horizontal privacy wall



Finished ceiling

### Specifications | Prairie Wood Pavilion

Please Note: Prairie Pavilions with sides of 20' and above will require additional posts.

Size	10'	12'	14'	16'	18'	20'	24'
X (Outside to outside slanted roof side)	160"	184"	208"	N/A	N/A	N/A	N/A
A (Outside to outside of roof)	144"	168"	192"	216"	240"	264"	312"
B (Center to center of posts)	113"	137"	161"	185"	209"	233"	281"
C (Overall height)	118"	120"	122"	N/A	N/A	N/A	N/A

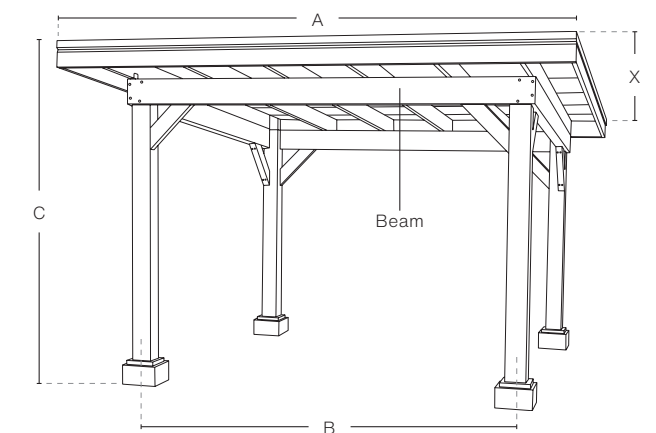

# Norwood

**STANDARD MODEL INCLUDES:**

- Western Red cedar timber
- Solid cedar 8" X 8" posts (no wire chase)
- 4" X 10" beams — 4" X 8" rafters
- 2" X 6" tongue-and-groove pine sheathing

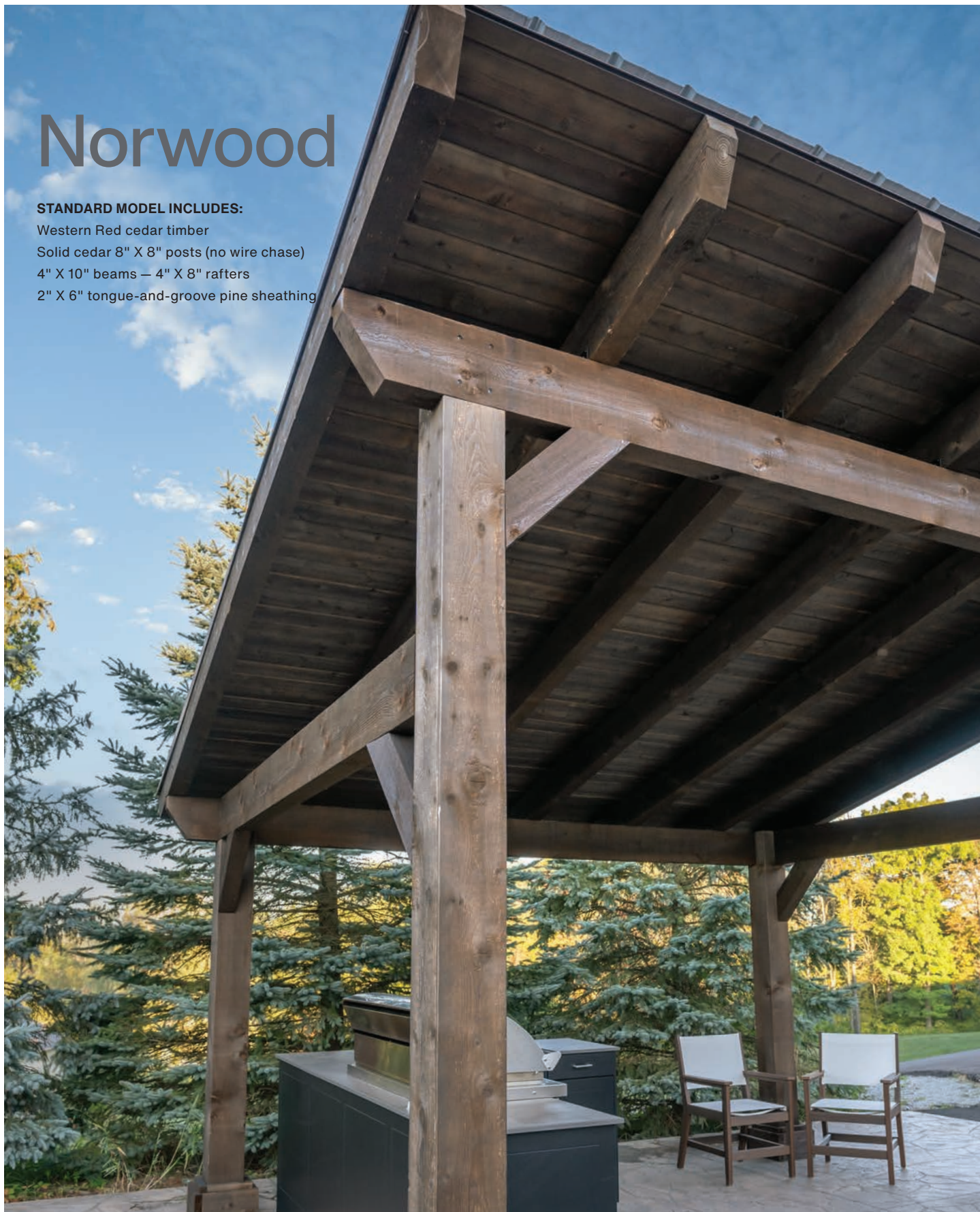

Norwood is a surefire way to enjoy your outdoor space.



*Metal privacy wall*



## Specifications | Norwood Wood Pavilion

*Please Note: Norwood Pavilions with sides of 20' and above will require additional posts.*

Size	10'	12'	14'	16'
X (Outside to outside slanted roof side)				
A (Outside to outside of roof)	12'	14'	16'	18'
B (Center to center of posts)	112"	136"	160"	184"
C (Overall height)	143"	149"	155"	161"
D	Distance from bottom of post to bottom of beam is 86"			
E	Distance from bottom of post to top of beam is 96"			

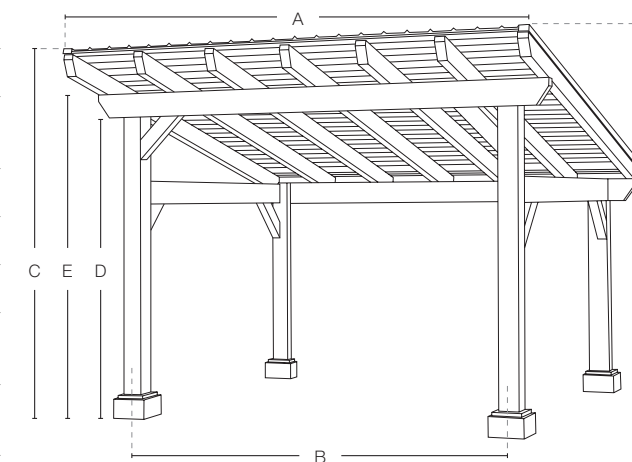



(Shown above): Round posts; Vinyl beaded ceiling





Victoria or Cascade interior:  
Tongue and groove wood ceiling



Standard Breckenridge interior:  
Triple rafter



Standard Cascade or Hampton interior:  
Painted exterior



Standard Breckenridge interior:  
Rafter roof



Victoria interior:  
Stained rafters and sheathing (Custom)



Standard Victoria interior:  
Painted rafters and stained sheathing



# Design a Vinyl or Composite Pavilion in 8 easy steps:

## 1 Choose a size.

### Things to consider:

- How much space do you have available?
- Berlin Gardens pavilions are available in many sizes.
- Measure your available space keeping in mind both post and roof dimensions (*roof extends 11" past post positions*).

### Victoria & Wellington Sizes:

Widths available: 10', 12', 14', 16', 18', 20'  
 Lengths available: 10', 12', 14', 16', 18', 20', 24'

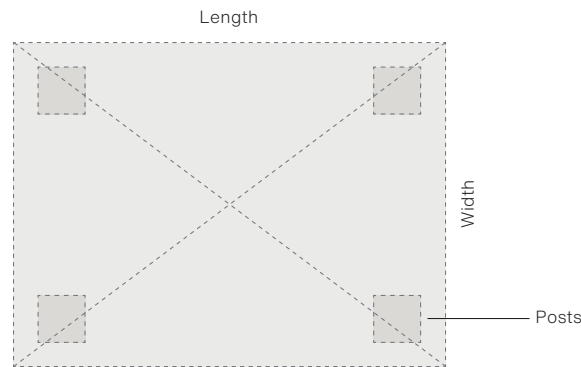

## 2 Choose a site type.

Concrete footers recommended.

*\*Concrete footer should be installed prior to structure.*

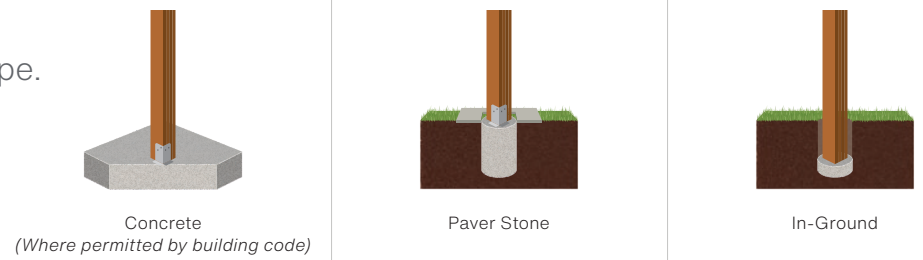

## 3 Choose a beam style.



## 4 Choose a post style.



Fabric options and accessories on pages 48-51

## 5 Choose a vinyl/composite color.

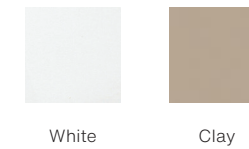

## 6 Choose a ceiling style.



## 7 Choose a roof style.



## 8 Choose a roofing material\*.

### 30-Year Architectural Asphalt Shingles

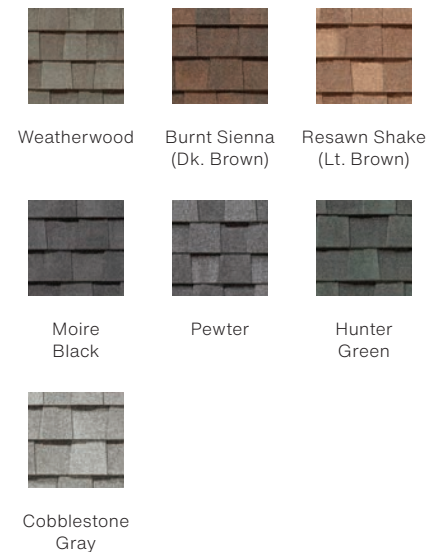

### Metal Roofing



*\*Please refer to in-person samples for an accurate color.*

# Design a Wood Pavilion in 7 easy steps:

## 1 Choose a style and size.

### Things to consider:

- How much space do you have available?
- Berlin Gardens pavilions are available in many sizes.
- Measure your available space keeping in mind both post and roof dimensions (*roof extends 11" past post positions*).

### Hampton Sizes:

Widths available: 10', 12', 14'  
Lengths available: 10', 12', 14', 16', 20'

### Breckenridge and Mesa Sizes:

Widths available: 10', 12', 14', 16', 18', 20'  
Lengths available: 10', 12', 14', 16', 18', 20', 24'

### Cascade Sizes:

Widths available: 10', 12', 14', 16', 18', 20'  
Lengths available: 10', 12', 14', 16', 18', 20', 24'

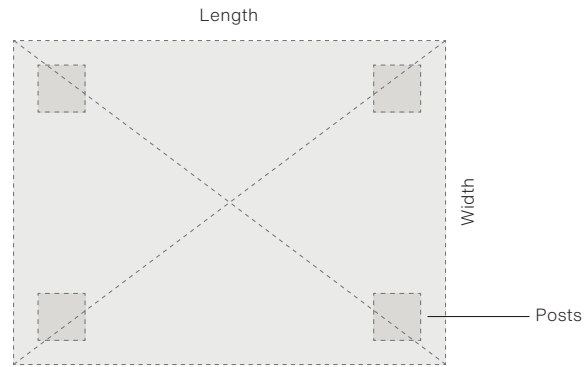

### Prairie Sizes:

Widths available: 10', 12', 14'  
Lengths available: 10', 12', 14', 16', 18', 20', 24'

### Norwood Sizes:

Widths available: 10', 12', 14', 16'  
Lengths available: 10', 12', 14', 16', 18', 20', 24'

## 2 Choose a site type.

Concrete footers recommended.

*\*Concrete footer should be installed prior to structure.*



## 3 Choose a beam style.



## 4 Choose a ceiling style.

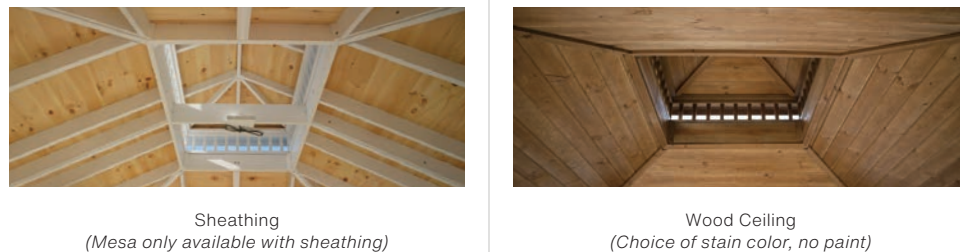

## 5 Choose a color.

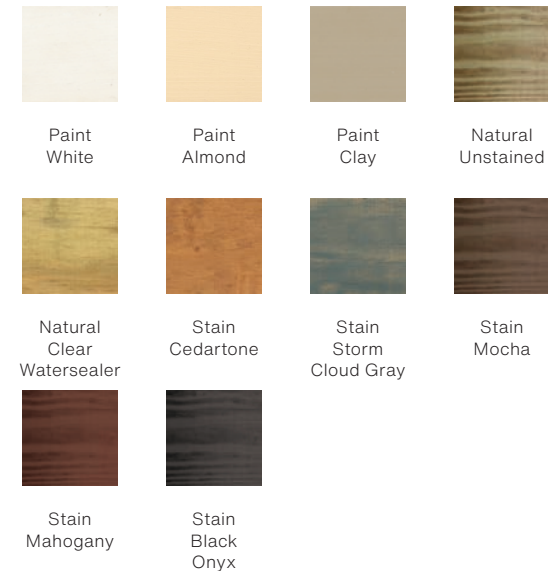

*\*Please refer to in-person samples for an accurate color.*

## 6 Choose a roof style.



## 7 Choose a roofing material\*.

### 30-Year Architectural Asphalt Shingles

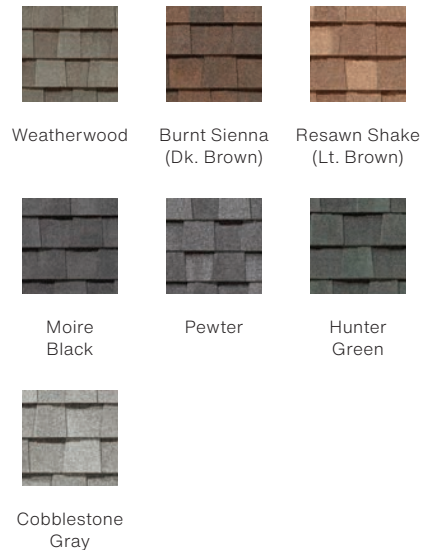

### Metal Roofing



*\*Please refer to in-person samples for an accurate color.*



*Cascade with Premier arched beams; Outback attached to house with Dia shade*



*Urbana with 8" X 8" posts; Straight braces*



*Cascade with Classic roof & Premier arched beams*



*Breckenridge with finished ceiling*



Fabric Group A



Fabric Group B



Fabric Group C

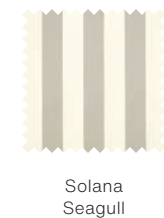

Dia Shade

(Pergola only)



Our Dia Shade allows you to control the amount of shade to create the optimal outdoor experience.

- Track is powder-coated white, bronze or black
- Stainless fasteners and components
- Available in all fabrics shown to the left
- Maximum width per section is 54"
- Track runs parallel with beams
- 10' and 12' purlin lengths will have two shade sections
- 14' and 16' purlin lengths will have three shade sections
- Not available in cut yardage



Curtains



*Curtains hang on an easy-to-install system.*

Curtains add warmth and privacy to your outdoor oasis and are available in many fabric options to fit your style.

- Standard Curtain Panel is 52" wide by 86" long
- Mounting hardware and rod available
- Available in all fabrics shown on pages 48-49
- Curtain rods are powder-coated, galvanized steel
- Rods are available in white, bronze and black



Privacy Wall

Privacy walls are the perfect addition to your structure lending some seclusion to your outdoor room.



*Horizontal Privacy Wall*

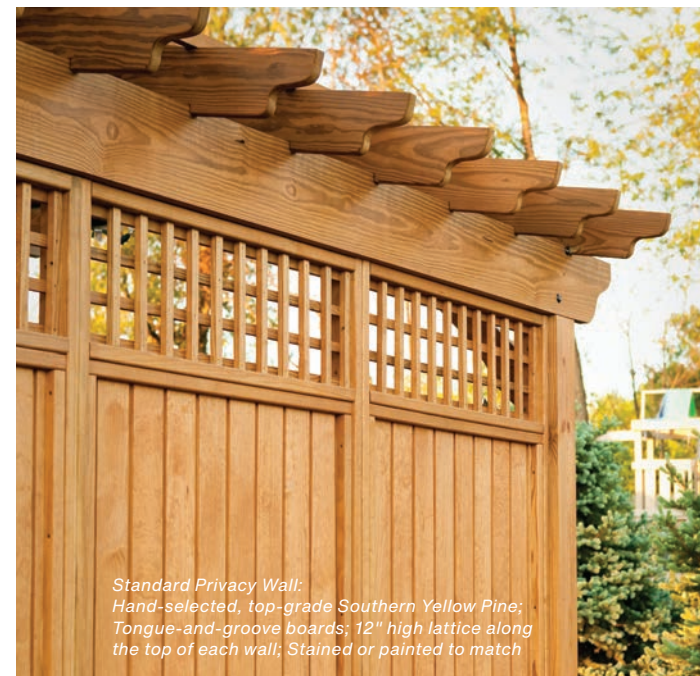

*Standard Privacy Wall:  
Hand-selected, top-grade Southern Yellow Pine;  
Tongue-and-groove boards; 12" high lattice along  
the top of each wall; Stained or painted to match*



*Louvered Privacy Wall*



*Metal Privacy Wall*

# BERLIN GARDENS

TAKE LIFE OUTDOORS™

[berlingardensllc.com](http://berlingardensllc.com)

800.593.3411

