

ATV and UTV Accessories

2014-2015



INTRODUCTION

My dealer number is: _____



PPE Enterprises trading as ATV City

Eleven Mile Lane,
Wymondham,
Norfolk,
NR18 9LR

Tel: 01953 609999
Fax: 01953 609998
sales@atvcity.co.uk
www.atvcity.co.uk

© 2014 ATV City

This catalogue is copyright 2014 ATV City. It may not, in whole or in part, be copied or reproduced in whole or in part, without the express written permission of ATV City. All images, graphics and descriptions herein are the property of ATV City, or are used with express written permission.

Disclaimer: While every effort is made to keep all information herein up to date, we cannot be responsible for typographical errors or erroneous information contained within this document, beyond the normal terms of our returns policy.



CONTENTS

1 - BEARINGS, BUSH KITS, BALLJOINTS

- 1-2 Standard Bearings
- 1-3 Wheel Bearing Kits
- 1-15 Rear Ring & Pinion Gears/Sets
- 1-16 Diff. Bearing Kits
- 1-26 Diff. Seal Kits
- 1-31 Swingarm Bearing Kits, Shock Bearing Kits, A-Arm Bearing Kits, Suspension Bearing/Bush Kits
- 1-39 Ball Joints
- 1-50 Steering Bearing Kits
- 1-55 King Pin Kits
- 1-56 Tie Rod End Kits

2 BRAKING

- 2-2 Brake Pads, Shoes and Discs
- 2-20 Brake Pad Diagrams
- 2-23 Brake Drum Seals
- 2-25 Brake Calipers
- 2-26 Master Cylinder Rebuild Kits
- 2-27 Brake Caliper Rebuild Kits
- 2-31 Wheel Cylinders & Rebuild Kits
- 2-32 Brake Drums & Backing Plates
- 2-33 Brake Cleaners & Lubricants

3 BULLBARS, MUDFLAP KITS

- 3-2 Bull Bar Kits, Mudflap Kits

4 CABLES

- 4-2 Cables
- 4-4 Cable Luber

5 CARBURETTOR PARTS

- 5-1 Carburettor Repair Kits
- 5-5 Carburettor Cleaner, Float Valves, Carburettor Tool Kits,

6 DRIVE LINE

- 6-2 Universal Joints
- 6-21 Universal Joint Size Charts
- 6-23 ATV/UTV CV Axles & Boot Kits
- 6-53 CV Boot Kit - Universal
- 6-55 Axles, Axle Hubs, Axles Nuts,

- 6-54 CVT Drive Belts - ATV
- 6-66 CVT Drive Belts - UTV

7 ELECTRICAL

- 7-2 Batteries
- 7-3 Battery Fitment Chart
- 7-6 CDI Units
- 7-8 Regulator Rectifiers
- 7-12 Stator Units
- 7-13 Bulbs & Fuses
- 7-14 Handlebar Parts, Heated grips, Switch Blocks, Kill Switches, Handlebar Grips
- 7-15 Spark Plugs & Caps
- 7-16 Spark Plug Fitment Chart
- 7-21 Starter Motors
- 7-27 Gear Shift Motors
- 7-28 Starter Brush Kits
- 7-29 Insulation Tape
- 7-30 Cigarette Plug, Solenoid Relays, Horns
- 7-31 Security - Tracker, Spot Lights, Electronic Cleaners
- 7-32 Ignition Switches
- 7-33 ATV Cooling Fans

8 EXHAUSTS

- 8-2 Exhausts, Gaskets & Clamps

9 MISCELLANEOUS

- 9-2 Puncture Repair Kits, Cable Ties
- 9-3 "Dog Mats, Handlebar Mittens, Plastic Fasteners (Mudguard Extending), Heated Grips, Fuel Line, Fuel Filter"
- 9-4 "Tow Balls, Tie Downs, Shock Absorbers, Gun Racks Windscreens, Cargo Nets"
- 9-5 "Gear Shift Levers, Bike Covers, Mirrors, Mirror Mounts, Tax Disc Holders, Grips, Indicators, Grip Lock (Glue)"
- 9-6 Tail Lights
- 9-7 Workshop Manuals -Clymer
- 9-8 "Service Stickers, Pull Start Handles/Rope, Diff. Filler Caps, Helmets, Universal Carrier Mount"
- 9-9 Winches
- 9-11 Winch mounts
- 9-12 Winch Accessories & Parts
- 9-13 Tool Boxes, Reflectors, Spot Lights
- 9-14 UTV Accessories

CONTENTS

10 FILTERS

- 10-2 Oil Filters
- 10-7 Fuel Filters, Fuel Pump, Air Filters

11 SEAT COVERS, OVER COVERS

- 11-2 Seat Covers - Staple On
- 11-5 Seat Over Covers

12 TOOLS

- 12-2 Workshop Tools and Consumables
- 12-6 Nuts, Bolts, Washers, Split Pins
- 12-12 CRC Sprays & Lubricants

13 TYRES

- 13-2 Innova ATV Tyres
- 13-5 Vee Rubber
- 13-6 Artrax
- 13-8 Tyre Fitment Chart
- 13-12 Tubes, Valves,
- 13-13 Puncture Repair Kits, Hub & Stub Wheel Kits
- 13-14 Tyre Bead Sealer, Tyre Mounting Paste

14 ENGINE COMPONENTS

- 14-2 Cam Chains
- 14-3 Gasket Sets
- 14-5 Piston Kits
- 14-7 Piston Ring Kits
- 14-8 Conrod Kits

15 SPRAYERS, BOOMS AND ACCESSORIES

- 15-2 Fimco Spot Sprayers
- 15-3 Fimco 3-Point Linkage Sprayer
- 15-4 Fimco Spreaders and Booms
- 15-6 Fimco Parts Manual
- 15-21 Pumps
- 15-22 Hand Lances

16 C-DAX PRODUCTS

- 16-2 SprayRider
- 16-3 SprayRider™ 50 & 80
- 16-3 Dual Tank Kit 50 & 80

- 16-4 Spray-On 200
- 16-5 Spray-On 400
- 16-6 Eliminator Weed Wiper
- 16-7 MultiBoom
- 16-7 3 & 4m Booms
- 16-8 Controlled Droplet Application (CDA)
- 16-8 Conventional Spraying vs CDA Spraying
- 16-9 CDA Booms
- 16-9 Amenity Boom
- 16-10 Lances and Spray Guns
- 16-10 12-Volt Pumps
- 16-10 Hose Reels
- 16-11 QuickSmart Attachment System
- 16-12 Tip Calibration Guide
- 16-13 SpreadMaster
- 16-14 SlugMaster
- 16-15 BoxMate
- 16-15 ATV Carrier Mat
- 16-16 Spotlight
- 16-16 Gun Rack
- 16-16 Universal Fitting Windscreen
- 16-16 Mud Flap Kits
- 16-17 C-DAX (ATV City) Terms of Trade

17 TERMS AND CONDITIONS, TYRE PATTERN GUIDE

- 17-2 Terms and Condition
- 17-4 Advertising Opportunities
- 17-5 Tyre Pattern Guide
- 17-7 Notes



INDEX

A

A-Arm Bush Kit	1-31
Air Con Cleaner	12-13
Air Filters	10-7
Allen Key Set	12-4
Alternators	7-21
Amenity Boom	16-9
Angle Sensors - Honda	7-27
ATV Carrier Mat	16-15
Axles	6-54
Axle Nuts	6-54
Axle Hubs	6-54

B

Ball Joints	1-39
Batteries	7-2
Battery Fitment Chart	7-3
Battery Pole Protect	7-2/7-31/12-13
Bearings - Diff. Kits	1-16
Bearings - Suspension Kits	1-31
Bearings - Standard	1-2
Bearings - Steering Kits	1-50
Bearings - Wheel Kits	1-3
Bolts - Flange	12-10
Bolts - Plain	12-9
Booms	16-7/16-9
BoxMate	16-15
Brake Adjusting Bung	2-32
Brake Calipers	2-25
Brake Caliper Rebuild Kits	2-27
Brake Cleaners & Lubricants	2-33/ 12-11
Brake Discs	2-2
Brake Drum Seals	7-13
Brake Drums & Backing Plates	2-32
Brake Lube	2-33
Brake Pads/ Shoes and Discs	2-20
Brake Pad Diagrams	2-23
Bulbs	7-13/12-3
Bullbars	3-2
Bungees	9-2/12-3

C

Cab Enclosure - UTV	9-14
Cables	4-2
Cable Luber	4-4 / 12-1
Cable Ties	9-2/12-2
Caliper - Brake	2-25
Cam Chains	14-2
Car Care	12-22
Carburettor Cleaner	5-5
Carburettor Repair Kits	5-1
Carburettor Tool Kit	5-5
Cargo Net	9-13
CDA Booms	16-9
CDI Units	7-6
Chain Lube	12-15

Cigarette Plug	7-30
Clamp - Fuel Line	9-3/12-2
Claw - Flexible	12-4
Cleaners - Air Con	12-13
Cleaners - Air Sensor	12-12
Cleaners - Carburettor	12-12
Cleaners - Electronic	12-12
Cleaners - Engine	12-12
Cleaners - Motor Clean	12-13
Clymer Workshop Manual	12-6
Complete CV Shaft	6-23
Conrod Kits	14-8
Controlled Droplet Application	16-8
Copper Paste	2-33/12-17
Covers - ATV	9-5
Covers - Seat	11-2
CRC	12-12
Crown Wheel + Pinion Kit	1-15
CV Boot Crimping Tool	12-4
CV Boot Kit - Universal	6-53
CV Shafts	6-23
CVT Drive Belts - ATV	6-55
CVT Drive Belts - UTV	6-66
CV Boot Kits	6-23

D

Dead Man Killswitch	7-14
Diff Filler Cap	9-8
Diff Repair Kits	1-26
Diff Seal Kit	1-26
Disc Brake Quiet	2-33
Disc Brakes	2-2
Dog Mat	9-3
Drive Belts	6-55
Dual Tank Kit	16-3

E

Ear Defenders	12-2
Eliminator Weed Wiper	16-6
Exhaust Mounting Paste	8-3
Exhaust/Mufflers	8-2
Exhaust Repair Bandage	8-3
Exhaust Repair Gum	8-3
Electronic Cleaners	7-31

F

Fan - Cooling / Motor	7-33
Fasteners	9-3 / 12-6
Filler Cap	9-8
Filters - Air	10-7
Filters - Oil	10-2
Fimco	15-1
Float Valves	5-5
Fuel Container	12-4
Fuel Filter	9-3/10-7
Fuel Hose	12-2
Fuel Line	9-3/12-2
Fuel Line Clamp	9-3/12-2
Fuel Pump	10-7

Funnel	12-4
Fuses	7-13/12-3

G

Galvanising Spray	12-26
Gasket Remover	12-19
Gasket Sets	14-3
Gear Shift Levers	9-5
Gear Shift Motors	7-27
Gloves - Workshop	12-3
Glow Plugs	7-15
Glue Aerosol	12-27
Grease	12-16
Grips	7-14
Grip Lock (Glue)	9-5
Gun Care	12-21
Gun Carrier - UTV	9-14
Gun Racks	9-4/16-16

H

Hammer - Rubber	12-4
Hand Holds UTV	9-15
Hand Lance	15-22
Handlebar Grips	7-14/9-5
Handlebar Heated Grips	7-14/9-3
Handlebar Mittens	9-3
Helmets	9-8
Hex Key Set, T-Handle	12-4
Horns	7-30
Hose Reels	16-10
Hub & Stubs	18-13

I

Ignition Switches	7-32
Indicators	9-5
Insulation Tape	12-2/7-29
IRS Bush Kits	1-31

J

Jump Leads	12-4
------------	------

K

Kill Switches	7-14
King Pin Kits	1-55
Knife	12-4

L

Lance - Hand Sprayer	15-22
Lances	16-10
Light Bulbs	7-13/12-3
Lock-Tite	12-20
Luggage Net	9-13

M

Master Cylinder Rebuild Kits	2-26
Maintenance Spray	12-14
Mirror/Mirror Mount	9-5
Mud Flap Bolts (Plastic)	9-3/12-2
Mud Flap Kits	3-2

INDEX

MultiBoom	16-7	Spanners	12-4	WD-40 (5-56)	12-14
Mud Flap Kits	16-16	Spark Plugs & Caps	7-15	Wheel Cylinders & Rebuild Kits	2-31
N		Split Pins	12-8	Wheel Hub & Stub Kits	13-13
Net - Cargo	9-13	Spot Light	7-31/9-13/16-16	Winch Accessories/Parts	9-12
Nuts - Castle	12-7	SpreadMaster	16-13	Winch Mounts	9-11
Nuts - Domed	12-7	Spray Guns	16-10	Windscreens	9-4
Nuts - Flanged	12-7	SprayOn	16-4,16-5	Windscreens - UTV	9-15
Nuts - Nyloc	12-7	SprayRider	16-2,16-3	Wire Brush	12-4
Nuts - Plain	12-6	Starter Brush Kits	7-28	Workshop Manuals	9-7
O		Starter Motors	7-21	Winches	9-9
Oil Filters	10-2	Stator Units	7-12	Wheel Bearing Kits	1-3
P		Steering Bearing Kits	1-50		
Paint	12-18	Steering Bush Kits	1-54		
Paint Pens	12-26	Super Glue	12-20		
Penetrating Oil	12-14	Suspension Bush Kits	1-31		
Pinion Kits	1-15	Swing Arm Bearing Kits	1-31		
Piston Kits	14-5	T			
Piston Ring Kits	14-7	T-Bar Allen Key	12-4		
Plastic Fasteners	9-3/12-2	T-Bar Screwdriver	12-4		
Pull Start Handle	9-8/12-4	T-Bar Socket Set	12-4		
Pull Start Rope	9-7/12-4	Tailgate Cable UTV	9-15		
Pumps - Sprayers	15-2	Tail Lights	9-6		
Pumps	16-10	Tap & Die Set	12-4		
Punch Set	12-4	Tape Measure	12-4		
Puncture Repair Kits	9-2/12-5/13-13	Tax Disc Holder	9-5/12-2		
Puncture Repair Strings	9-2/12-5/13-13	Tie Downs	9-4/12-5		
Puncture Preventer Liquid	9-2/13-8	Tie Rod Kits	1-56		
Q		Tip Calibration Guide	16-12		
QuickSmart Attachment System	16-11	Tool Boxes	9-13		
R		Tow Balls	9-4/12-5		
Rack & Pinion Tie Rod Kits	1-57	Tow Hitch Assy	9-4		
Reflectors	9-13/12-5	Tubes	13-12		
Regulators/Rectifiers	7-8	Tyre	13-2		
Relays - Solenoids	7-30	Tyre Bead Sealer	13-9/12-5/13-14		
Roll Cage Organiser - UTV	9-15	Tyre Fitment	13-8		
Roll Cage Top - UTV	9-14	Tyre Mounting Paste	12-5/13-9/13-14		
S		Tyre Pressure Gauge	12-5		
Safety Glasses	12-2	Tyre Sealer	12-5/13-9/13-14		
Seal Kits - Diff.	1-26	Tyre Valves / Cores / Caps	12-5/13-7		
Seat Covers	11-2	U			
Seat Heater	7-14/11-2	Universal Carrier Mount	9-8		
Seat Over Covers	11-5	Universal Fitting Windscreen	16-16		
Seat Over Covers - UTV	9-15	Universal Joints	6-2		
Seat Repair Sticker	11-2	Universal Joints Size Chart	6-21		
Security - Tracker	7-31	UTV Accessories	9-14		
Service Stickers	9-8/12-2	V			
Shock Absorbers	9-4	Valves - Tyre	13-12		
Shock Bushes	1-31	Valve Core Removal Tool	12-5/13-12		
SlugMaster	16-14	Vernier Gauge	12-4		
Silicone Spray	12-15	Volt Pumps	16-10		
Socket Set T-Bar	12-4	W			
Screwdriver T-Bar	12-4	Washers Bumper	12-8		
Solenoid Relays	7-30	Washers Flat	12-8		
		Washers Spring	12-8		



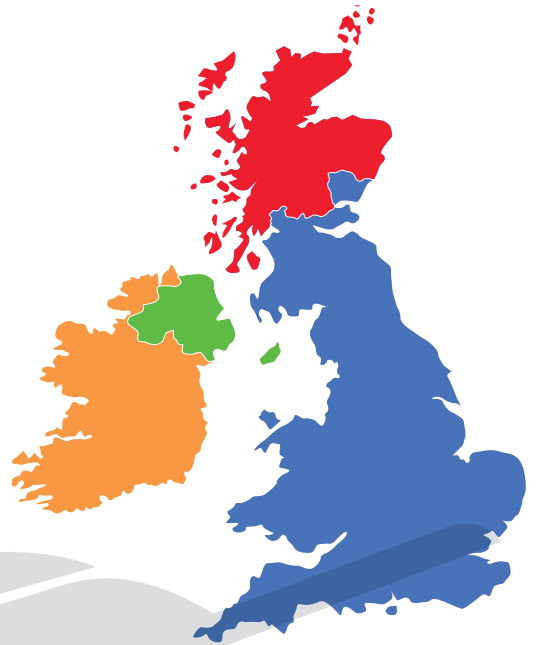

DELIVERY TARIFF 2014

DELIVERY CHARGES:

AREA	SPEND UNDER £120.00	SPEND OVER £120.00
BLUE AREA	<p>All Parcels up to 30kg: £7.50 for the first parcel, then £5.00 per subsequent parcel. Next Day Service*</p> <p>(Isle of Wight Surcharge: £7.50 extra) *Extra Charge for premium delivery services, please call for prices</p>	<p>CARRIAGE PAID*</p> <p>*For next day service only. Does not include any premium delivery surcharges</p>
RED AREA	<p>Each Parcel up to 30kg: £16.00 2-3 day service</p>	<p>Single Parcel £8.00 Multiple Parcels £4.50 per parcel</p>
	Scottish offshore islands – Extra surcharge of £13.50 per consignment	
GREEN AREA	<p>Each Parcel up to 30kg: £16.00 2-3 day service</p>	<p>Single Parcel £8.00 Multiple Parcels £4.50 per parcel</p>
ORANGE AREA	<p>Each Parcel up to 30kg: £16.00 2-3 day service</p>	<p>Single Parcel £8.00 Multiple Parcels £4.50 per parcel</p>

For oversize items there will be a surcharge



INTERNATIONAL DELIVERY TARIFF 2014

DELIVERY CHARGES:

AREA	SPEND UNDER £200.00	SPEND OVER £200.00
	(Each parcel weighing up to 30kg. Large items i.e. tyres, sprayers etc, we will quote for.) * Delivery times may vary	(Each parcel weighing up to 30kg. Large items i.e. tyres, sprayers etc, we will quote for.) * Delivery times may vary
BLUE AREA 5, 6, 7, 9, 10	£14.00	£7.00
RED AREA 8, 11, 17	£16.00	£8.00
GREEN AREA 4, 12, 16, 21	£18.00	£9.00
ORANGE AREA 1, 3, 13, 14, 15, 18, 19, 20, 22, 23, 24, 25, 26, 27, 28, 29, 30, 31, 35, 36	£25.00	£15.00
YELLOW AREA 32, 33, 34, 37, 38	CALL OR EMAIL FOR PRICE	



the best part of your atv

- 1: BEARINGS, BUSH KITS, BALLJOINTS
- 2: BRAKING
- 3: BULLBARS, MUDFLAP KITS
- 4: CABLES
- 5: CARBURETTOR PARTS
- 6: DRIVE LINE / CVT BELTS / AXLES
- 7: ELECTRICAL
- 8: EXHAUSTS
- 9: MISCELLANEOUS
- 10: FILTERS
- 11: SEAT COVERS, OVER COVERS
- 12: TOOLS
- 13: TYRES / TUBES / RIMS
- 14: ENGINE COMPONENTS
- 15: SPRAYERS & SPRAYER ACCESSORIES



1: BEARINGS, BUSH KITS, BALL JOINTS

BEARINGS STANDARD

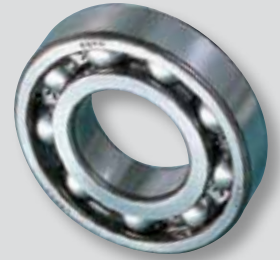

Bearings

ATV City Part No.	Bearing	Model
200.30203	30203-4T YAMAHA SWINGARM	YFM/YFB KVF360 SWING ARM 92116-1001
200.60/32	60/32 91055-HA0-681	TRX350-450 L/H AXLE TUNNEL (OEM 91055-HA0-681) (Seal to suit above 530.5811)
200.6001	6001-2RS	
200.6002	6002-2RS	
200.6003	6003-2RS	
200.6004	6004-2RS	
200.6005	6005-2RS	KAWASAKI MULE FRT WHEEL BRG
200.6006	6006-2RS	YAMAHA/SUZUKI FRONT WHEEL BEARING
200.6007	6007-2RS	
200.6201	6201-2RS	
200.6202	6202-2RS	
200.6203	6203-2RS	
200.6204	6204-2RS	
200.6205	6205-2RS	KLF220-400 L/H REAR AXLE
200.6301	6301-2RS	
200.6302	6302-2RS	
200.6303	6303-2RS	
200.6304	6304-2RS	
200.6904	6904-2RS	
200.7203	7203B 91066-HC4	TRX300-450 SWINGARM
200.DG4070	DG4070	
200.1030-30	1030-30	Polaris 900 Diesel Front Prop Bearing O.E.M Ref 3514703
200.UC205	UC205	Mule 3010/4010 Front Prop Shaft Bearing
200.P205	P205	Mule 3010/4010 Front Prop Shaft Bearing Block OEM RUF #92138-1052

Bearings

Braking

Bullbars

Cables

Carburettor

Driveline

Electrical

Exhausts

BEARINGS WHEEL/SEAL KITS



Arctic Cat

Engine	Year	Description	Front Wheel Bearing Kit	Rear Wheel Bearing Kit
50	2008	50 2x4	525.1395	525.1435
50	2004 - 06	50 Y-6 Youth	525.1395	525.1396
90	2006 - 13	90 DVX / Utility / Y-12	525.1395	525.1396
150	2009 - 13	150 Utility	525.1049	525.1595
250	1999 - 05	250 2x4 / 4X4	525.1434	525.1434
250	2006 - 09	250 2x4	525.1035	
250	2005	250 4x4	525.1496	525.1496
250	2006 - 08	DVX250	525.1035	525.1527
300	1998 - 04	300 2x4 / 4x4	525.1434	525.1434
300	2010 - 12	300 2x4	525.1035	
300	2005	300 4x4	525.1496	525.1496
300	2009 - 12	DVX300	525.1035	525.1527
350	2011	350 Utility 4x4	525.1496	525.1496
366	2008 - 11	366 FIS w/AT	525.1496	525.1496
375	2002	375 2x4 4x4 w/AT	525.1434	525.1436
400	1998 - 00	400 2x4	525.1434	525.1433
400	2001	400 2x4	525.1434	525.1436
400	2003 - 04	400 2x4 FIS w/AT - w/MT	525.1434	525.1434
400	2009 - 13	400 FIS 4x4 TRV	525.1496	525.1496
400	2002 - 04	400 FIS 4x4 w/AT - w/MT	525.1434	525.1434
400	2005 - 08	400 FIS 4x4 w/AT - w/MT	525.1496	525.1496
400	2004	400 TBX 4x4	525.1434	525.1434
400	2005 - 06	400 TBX 4x4	525.1496	525.1496
400	2007	400 TRV	525.1496	525.1496
400	2006	400 VP 4x4	525.1496	525.1496
425	2011 - 12	425 Utility 4x4	525.1496	525.1496
450	2010 - 11	450 H1	525.1496	525.1496
450	2011 - 12	450XC 4x4	525.1496	525.1496
454	1996 - 98	454 2x4	525.1434	525.1433
500	1998 - 99	500 4x4	525.1434	525.1433
500	2000 - 02	500 4x4 w/AT - w/AT	525.1434	525.1436
500	2002 - 04	500 FIS 4x4 w/AT - w/MT	525.1434	525.1434
500	2005 - 09	500 FIS 4x4 w/AT - w/MT	525.1496	525.1496
500	2002	500 FIS TBX 4x4	525.1434	525.1436
500	2003 - 04	500 FIS TBX / TRV 4x4	525.1434	525.1434
500	2005 - 08	500 FIS TBX / TRV 4x4	525.1496	525.1496
550	2009 - 12	550 GT / H1 / TRV EFI 4X4	525.1496	525.1496

BEARINGS WHEEL/SEAL KITS



Bearings

Braking

Bullbars

Cables

Carburettor

Driveline

Electrical

Exhausts



Arctic Cat (continued)

Engine	Year	Description	Front Wheel Bearing Kit	Rear Wheel Bearing Kit
550	2009 - 13	550 Prowler XT & EFI	525-1496	525.1496
650	2006 - 09	650 Prowler XT	525.1496	525.1496
650	2005 - 11	650 4x4 H1	525.1496	525.1496
650	2004	650 4x4 w/AT V2	525.1434	525.1496
650	2005 - 06	650 4x4 w/AT V2	525.1496	525.1496
700	2012	HDX	525.1496	525.1496
700	2008 - 13	700 Prowler XTX & EFI	525.1496	525.1496
700	2008 - 13	700 Diesel / EFI / H1 / GT / TRV	525.1496	525.1496
1000	2011 - 13	1000 Prowler H2 XTZ & EFI	525.1496	525.1496
1000	2009 - 10	Prowler H2 1000 XTZ	525.1496	525.1496
1000	2012	1000i GT	525.1496	525.1496
1000	2010 - 11	H2 MUDPRO	525.1496	525.1496
1000	2008 - 11	H2 THUNDERCAT	525.1496	525.1496
1000	2012 - 13	WILDCAT	525.1496	525.1496

Can Am

Engine	Year	Description	Front Wheel Bearing Kit	Rear Wheel Bearing Kit
50	2002 - 14	DS 50 / 70 / 90	525.1395	525.1396
175	2003 - 07	Rally 175	525.1431	525.1495
250	2006 - 14	DS 250	525.1566	
330	2004 - 05	Outlander 330	525.1520	
400	2003 - 05	Outlander 400	525.1520	
400	2006 - 14	Outlander 400 / 500	525.1516	525.1516
500	2002 - 03	Quest 500	525.1519	525.1518
500	2008 - 14	Renegade 500	525.1516	525.1516
500	1999 - 01	Traxter 500	525.1509	525.1518
500	2002 - 05	Traxter 500	525.1519	525.1518
650	2000 - 07	DS650	525.1431	525.1432
650	2007 - 14	Outlander 650	525.1516	525.1516
650	2002 - 04	Quest 650	525.1519	525.1518
650	2004 - 05	Traxter 650	525.1519	525.1518
800	2006 - 14	Outlander 800	525.1516	525.1516
800	2007 - 14	Renegade 800	525.1516	525.1516
800	2011 - 13	Commander 800	525.1516	525.1516
1000	2011 - 13	Commander 1000	525.1516	525.1516
1000	2012 - 14	Renegade 1000	525.1516	525.1516

BEARINGS WHEEL/SEAL KITS



Honda

Engine	Year	Description	Front Wheel Bearing Kit	Rear Wheel Bearing Kit
70	1973 - 77	ATC70	525.1187	525.1277
70	1978 - 85	ATC70	525.1187	525.1108
70	1986 - 87	TRX70	525.1050	525.1108
90	1973 - 78	ATC90	525.1049	525.1116
90	1993 - 14	TRX90	525.1052	525.1029
110	1979 - 81	ATC110	525.1211	525.1122
110	1982 - 85	ATC110	525.1317	525.1122
125	1984 - 85	ATC125M	525.1317	525.1122
125	1986 - 87	ATC125M	525.1317	525.1032
125	1985 - 86	TRX125	525.1052	525.1122
125	1987 - 88	TRX125	525.1052	525.1032
185	1980 - 83	ATC185	525.1317	525.1122
200	1982 - 83	ATC200E	525.1317	525.1122
200	1984	ATC200ES	525.1317	525.1365
200	1984 - 85	ATC200M	525.1317	525.1122
200	1984 - 86	ATC200S	525.1317	525.1122
200	1983 - 85	ATC200X	525.1317	525.1122
200	1986 - 87	ATC200X	525.1317	525.1445
200	1984	TRX200	525.1112	525.1365
200	1990 - 97	TRX200, TRX200D	525.1510	525.1124
200	1986 - 87	TRX200SX	525.1208	525.1126
250	1985 - 87	ATC250ES	525.1317	525.1036
250	1985	ATC250SX	525.1317	525.1019
250	1986 - 87	ATC250SX	525.1317	525.1036
250	1977 - 84	FL250	525.1070	525.1114
250	1985 - 87	TRX250 Fourtrax	525.1112	525.1036
250	1997 - 14	TRX250 Recon	525.1510	525.1034
250	2001 - 14	TRX250EX Sportrax	525.1083	525.1034
300	1988 - 92	TRX300 Fourtrax 300 2WD	525.1035	525.1123
300	1993 - 00	TRX300 Fourtrax 300 2WD	525.1112	525.1123
300	1988 - 00	TRX300FW Fourtrax 4x4	525.1003	525.1123
350	1985	FL350	525.1112	
350	1986	TRX350	525.1028	525.1036
350	1987 - 89	TRX350 D	525.1004	525.1036
350	2000 - 06	TRX350FE / FM 4x4	525.1513	525.1037
350	2000 - 06	TRX350TE / TM 2x4	525.1510	525.1037
400	2004 - 07	TRX400FA	525.1513	525.1037

BEARINGS WHEEL/SEAL KITS



Bearings

Braking

Bullbars

Cables

Carburettor

Driveline

Electrical

Exhausts



Honda (continued)

Engine	Year	Description	Front Wheel Bearing Kit	Rear Wheel Bearing Kit
400	1995 - 03	TRX400FW Fourtrax Foreman 4X4	525.1005	525.1037
420	2009 - 14	TRX420 FA	525.1003	525.1624
420	2007 - 13	TRX420 FE/FM	525.1003	525.1580
420	2007 - 13	TRX420 TE/TM	525.1530	525.1580
420	2014	TRX420FE/FM/TE/TM	525.1688	525.1689
450	1998 - 04	TRX450S/ES/FE/FM	525.1005	525.1037
500	2001 - 04	TRX500FA	525.1005	525.1037
500	2005 - 14	TRX500FA	525.1572	525.1037
500	2005 - 13	TRX500FE / FM	525.1572	525.1037
500	2005 - 06	TRX500TM	525.1530	525.1037
500	2014	TRX500FE/FM	525.1688	525.1689
650	2003 - 05	TRX650 Rincon	525.1005	525.1480
680	2006 - 14	TRX680 Rincon	525.1572	525.1480
700	2008 - 09	TRX700XX	525.1576	525.1624

Kawasaki

Engine	Year	Description	Front Wheel Bearing Kit	Rear Wheel Bearing Kit
50	2003 - 06	KFX50	525.1194	525.1397
50	2007 - 14	KFX50	525.1395	525.1396
80	2003 - 06	KFX80	525.1194	525.1158
90	2007 - 14	KFX90	525.1395	525.1396
220	1988 - 11	KLF220 / 250 Bayou	525.1088	525.1275
300	2012 - 14	KVF300 Brute Force	525.1035	
300	1986 - 87	KLF300A Bayou	525.1070	525.1274
300	1988 - 04	KLF300B Bayou	525.1023	525.1274
300	1989 - 04	KLF300C Bayou 4X4	525.1502	525.1275
300	1999 - 02	KVF300A Prairie 4x4	525.1502	525.1146
300	1999 - 00	KVF300B Prairie 2x4	525.1502	525.1146
300	2001 - 02	KVF300B Prairie 2x4	525.1497	525.1146
360	2003 - 13	KVF360A /B / C Prairie 4x4	525.1497	
400	1993 - 99	KLF400 Bayou	525.1502	525.1275
400	1997 - 01	KVF400A / D Prairie 4x4	525.1502	525.1146
400	2002	KVF400C Prairie 4x4	525.1497	525.1146
400	2001 - 02	KVF400D Prairie	525.1497	525.1146
650	2005 - 13	KVF650 Brute force	525.1497	

BEARINGS WHEEL/SEAL KITS



Kawasaki (continued)

Engine	Year	Description	Front Wheel Bearing Kit	Rear Wheel Bearing Kit
650	2006 - 13	KVF650 I Brute force	525.1497	525.1536
650	2002 - 03	KVF650 Prairie	525.1497	
700	2004 - 09	KFX 700 V-Force	525.1035	
700	2004 - 06	KVF700 Prairie	525.1497	
750	2005 - 14	KVF750 Brute Force / EPS	525.1497	525.1536
300	1991 - 04	Mule 500 / 520 / 550	525.1403	525.1274
400	2005 - 14	Mule 600	525.1536	525.1571
400	2005 - 14	Mule 610 4X4	525.1536	525.1571
450	1988	Mule 1000	525.1403	525.1405
540	1990 - 91	Mule 2010 / 2020 / 2030	525.1404	525.1405
620	1993 - 00	Mule 2500 2510 / 2520	525.1404	525.1405
620	2001 - 08	Mule 3000	525.1404	525.1536
620	2001 - 03	Mule 3020	525.1404	525.1536
620	2009 - 14	Mule 4000 / 4010 4x4	525.1404	525.1536
750	2008 - 13	TERYX 750 4X4	525.1496	525.1536
950	2000	Mule 2510 Diesel	525.1404	525.1405
950	2003 - 06	Mule 3010 Diesel	525.1404	525.1536
950	2010 - 11	Mule 4010 4x4 Diesel	525.1404	525.1536
950	2001 - 02	Mule 2510 Diesel	525.1404	525.1536

Kymco

Engine	Year	Description	Front Wheel Bearing Kit	Rear Wheel Bearing Kit
50		MAXXER 50	525.1395	525.1401
50	2003 - 08	Mongoose 50 2 & 4 stroke	525.1395	525.1396
50		MXer 50	525.1049	525.1595
50		MXU 50	525.1049	525.1595
70	2006 - 08	Mongoose	525.1395	525.1396
90	2004 - 05	Mongoose 90	525.1395	525.1396
150	2004 - 05	MXer 150	525.1049	525.1595
150	2005 - 08	MXU 150	525.1049	525.1595
250		KXR250	525.1035	525.1527
250		MAXXER250	525.1035	525.1527
250	2004 - 08	Mongoose 250	525.1035	525.1527
250	2004 - 05	MXU250	525.1035	525.1527

BEARINGS WHEEL/SEAL KITS



Bearings

Braking

Bullbars

Cables

Carburettor

Driveline

Electrical

Exhausts



Kymco (continued)

Engine	Year	Description	Front Wheel Bearing Kit	Rear Wheel Bearing Kit
300		MAXXER300	525.1035	525.1527
300	2005 - 08	Mongoose 300	525.1035	525.1527
300	2005 - 08	MXU 300	525.1035	
400		MXU 400	525.1496	525.1496
500		MXU 500 2WD	525.1496	525.1592
500		MXU 500 4WD	525.1496	525.1592

Polaris

Engine	Year	Description	Front Wheel Bearing Kit	Rear Wheel Bearing Kit
0	2011 - 12	LSV Electric	525.1424	525.1150
0	2010 - 13	Ranger EV4X4	525.1424	525.1150
50	2008 - 13	Outlaw 50	525.1395	525.1499
50	2004 - 07	Predator 50	525.1395	525.1499
50	2001 - 03	Scrambler 50	525.1395	525.1396
90	2007 - 14	Outlaw 90	525.1395	525.1435
90	2003	Predator 90	525.1395	525.1396
90	2004 - 06	Predator 90	525.1395	525.1435
90	2001 - 03	Scrambler / Sportsman 90	525.1395	525.1396
90	2004 - 14	Sportsman 90	525.1395	525.1435
170	2009 - 14	Ranger RZR170	525.1665	525.1667
200	2005	Phoenix 200	525.1500	
200	2006 - 14	Phoenix 200	525.1541	
200	2007	Sawtooth 200	525.1541	
250	1990 - 98	Trail Blazer 250	525.1129	525.1321
250	1999 - 04	Trail Blazer 250	525.1129	525.1151
250	2005 - 06	Trail Blazer 250	525.1500	525.1151
250	1988 - 99	Trail Boss 250	525.1129	525.1321
250	1987 - 93	Trail Boss 250 4x4	525.1008	525.1321
250	2000 - 02	Xplorer 250 4X4	525.1008	525.1151
300	1994 - 95	300 2x4	525.1129	525.1321
300	1994	300 4X4	525.1008	525.1321
300	2006 - 07	Hawkeye 2x4 / 4x4	525.1424	525.1424
300	2008 - 11	Hawkeye 2x4	525.1424	525.1424
300	2008 - 10	Sportsman 300 4X4	525.1424	525.1424
300	1995	Trail Boss 300 4X4	525.1008	525.1321
300	1996 - 98	Xplorer 300 4x4	525.1008	525.1321
300	1999	Xplorer 300 4x4	525.1008	525.1152
300	1996 - 99	Xpress 300	525.1129	525.1321

BEARINGS WHEEL/SEAL KITS



Polaris (continued)

Engine	Year	Description	Front Wheel Bearing Kit	Rear Wheel Bearing Kit
325	2000 - 01	Magnum 325 2x4	525.1129	525.1322
325	2002	Magnum 325 2x4	525.1129	525.1424
325	2000 - 01	Magnum 325 4x4	525.1008	525.1322
325	2002	Magnum 325 4x4	525.1008	525.1424
325	2001	Magnum 325 4x4 HDS	525.1424	525.1424
325	2002	Magnum 325 4x4 HDS	525.1424	525.1424
325	2000 - 02	Trail Boss 325	525.1129	525.1151
325	2000 - 01	Xpedition 325	525.1008	525.1322
325	2002	Xpedition 325	525.1008	525.1424
330	2004 - 05	ATP 330 4X4	525.1424	525.1424
330	2003 - 05	Magnum 330 2x4	525.1129	525.1424
330	2003 - 05	Magnum 330 4x4	525.1424	525.1424
330	2008 - 09	Trail Blazer 330	525.1500	525.1151
330	2010 - 13	Trail Blazer 330	525.1424	525.1151
330	2003 - 04	Trail Boss 330	525.1129	525.1151
330	2005 - 09	Trail Boss 330	525.1500	525.1151
330	2010 - 12	Trail Boss 330	525.1424	525.1151
335	1999 - 00	Sportsman 335	525.1008	525.1150
335	1999	Worker 335	525.1008	525.1150
380	2000	Scrambler 380 2x4	525.1129	525.1151
400	2001 - 02	Scrambler 400 2x4	525.1129	525.1151
400	1995 - 97	Scrambler 400 4x4	525.1008	525.1321
400	1998 - 02	Scrambler 400 4x4	525.1008	525.1151
400	1994 - 98	Sport 400	525.1129	525.1321
400	1999	Sport 400	525.1129	525.1151
400	1994 - 97	Sportsman 400 4x4	525.1008	525.1321
400	2001 - 03	Sportsman 400 4x4	525.1008	525.1150
400	2005	Sportsman 400 4X4	525.1424	525.1150
400	2004	Sportsman 400 4x4 AA AE AG	525.1008	525.1150
400	2004	Sportsman 400 4X4 AQ-AV	525.1424	525.1150
400	2008 - 10	Sportsman 400 HO 4x4	525.1424	525.1424
400	2011 - 14	Sportsman 400 HO 4x4	525.1424	525.1150
400	2003	Trail Blazer 400	525.1129	525.1151
400	1995 - 98	Xplorer 400L 4x4	525.1008	525.1321
400	1999 - 02	Xplorer 400L 4x4	525.1008	525.1151
400	1996 - 97	Xpress 400L 2x4	525.1129	525.1321
400	2012 - 14	Hawkeye 400 HO 2x4	525.1424	525.1150

BEARINGS WHEEL/SEAL KITS



Bearings

Braking

Bullbars

Cables

Carburettor

Driveline

Electrical

Exhausts



Polaris (continued)

Engine	Year	Description	Front Wheel Bearing Kit	Rear Wheel Bearing Kit
425	1995 - 98	Magnum 425 2x4	525.1129	525.1321
425	1996	Magnum 425 4x4	525.1008	
425	1998	Magnum 425 4x4	525.1008	525.1321
425	2000 - 01	Xpedition 425	525.1008	525.1322
425	2002	Xpedition 425	525.1008	525.1424
450	2006 - 07	Sportsman 450	525.1424	525.1150
455	1999 - 01	Diesel 455 4x4	525.1008	525.1150
500	2004	ATP 500 4X4	525.1424	525.1424
500	2005	ATP 500 4X4	525.1424	525.1424
500	2002 - 05	ATV 500 Pro / 4x4	525.1424	525.1424
500	2002	Magnum 500 2x4 HDS	525.1129	525.1424
500	1999 - 01	Magnum 500 4x4	525.1008	525.1322
500	2001 - 03	Magnum 500 4x4 HDS	525.1424	525.1424
500	2003	PTV Series 10 4x4	525.1424	525.1424
500	2000 - 02	Scrambler 500 2x4	525.1129	525.1151
500	2008	Scrambler 500 2x4	525.1500	525.1151
500	1997	Scrambler 500 4x4	525.1008	525.1321
500	1998 - 09	Scrambler 500 4x4	525.1008	525.1151
500	2010 - 12	Scrambler 500 4x4	525.1424	525.1151
500	1996 - 03	Sportsman 500 4x4 / DUSE / HO / RSE	525.1008	525.1150
500	2005 - 13	Sportsman 500 4x4 HO	525.1424	525.1150
500	2004	Sportsman 500 4x4 HO AA- AC- AE- AG	525.1008	525.1150
500	2004	Sportsman 500 4x4 HO AO - AW	525.1424	525.1150
500	2006 - 09	Sportsman 500 X2	525.1424	525.1150
500	2000 - 08	Sportsman 500 6x6	525.1008	525.1151
500	2011 - 13	Sportsman Forest / Tractor 500	525.1424	525.1150
	2008 - 13	Sportsman Touring 500 EFI	525.1424	525.1150
500	1999 - 02	Worker 500 4x4	525.1008	525.1150
500	1997	Xplorer 500	525.1008	525.1150
550	2010 - 14	Sportsman 550 EPS / X2 / Touring / Forest / XP	525.1628	525.1628
570	2014	Sportsman 570	525.1424	525.1150
600	2003 - 05	Sportsman 600 4x4	525.1424	525.1150
700	2002 - 08	Sportsman 700 4x4 / Twin / MV7 / X2	525.1424	525.1150
800	2005 - 13	Sportsman 800 EFI / X2	525.1424	525.1150

BEARINGS WHEEL/SEAL KITS



Polaris (continued)

Engine	Year	Description	Front Wheel Bearing Kit	Rear Wheel Bearing Kit
800	2009 - 12	Sportsman 800 EFI 6x6	525.1424	525.1150
500	2004	Ranger 6X6 500	525.1424	525.1150
500	2007	Ranger Series 10 Et 11 4x4 Et 6x6	525.1424	525.1150
700	2005 - 08	Ranger 4x4 700	525.1424	525.1150
700	2009	Ranger 4x4 700	525.1628	525.1150
700	2007 - 09	Ranger 4x4 700 Et CREW	525.1424	525.1150
700	2006 - 09	Ranger 6x6 700 EFI	525.1424	525.1150
800	2010 - 14	Ranger 4x4 800 EFI Et CREW	525.1628	525.1150
800	2010 - 14	RANGER 6X6 800	525.1628	525.1150
800	2011	RANGER RZR 4/EPS RGE	525.1628	525.1150
800	2009	RANGER RZR S 800	525.1615	525.1150
800	2010 - 14	RANGER RZR S 800	525.1628	525.1150
800	2012	RANGER XP 800	525.1628	525.1150
800	2008 - 09	RZR 800	525.1615	525.1150
800	2011 - 13	RZR 800	525.1628	525.1150
800	2010	RZR 800 Built 1/01/10 and after	525.1628	525.1150
800	2010	RZR 800 Built 12/31/09 and Before	525.1615	525.1150
900	2011 - 14	Ranger 4x4 900 D	525.1628	525.1150
900	2012 - 14	Ranger 4x4 CREW DIESEL 900 D	525.1628	525.1150
900	2011 - 14	Ranger RZR XP 900	525.1628	525.1628
850	2009 - 14	Sportsman 850 Forest / XP / X2 / EPS	525.1628	525.1628
400	2010 - 14	Ranger 400 4X4	525.1424	525.1150
800	2013 - 14	Ranger 4X4 800 EFI Midsize	525.1424	525.1150

Suzuki

Engine	Year	Description	Front Wheel Bearing Kit	Rear Wheel Bearing Kit
50	1984 - 87	LT-50	525.1045	525.1364
50	2002 - 05	LT-A / LT-Z50	525.1194	525.1397
80	1987 - 06	LT-80	525.1194	525.1158
90	2007 - 09	LT-Z90 QUADSPORT	525.1194	525.1158
160	1989 - 04	LT-160	525.1215	525.1122
250	1985 - 86	LT-250EF	525.1043	525.1145
250	1987	LT-4WD 250	525.1108	525.1477

BEARINGS WHEEL/SEAL KITS



Bearings

Braking

Bullbars

Cables

Carburettor

Driveline

Electrical

Exhausts



Suzuki

Engine	Year	Description	Front Wheel Bearing Kit	Rear Wheel Bearing Kit
250	1988 - 98	LT-4WD 250	525.1108	525.1299
250	1988 - 01	LT-F250	525.1108	525.1299
250	2002 - 12	LT-F250 Ozark	525.1215	525.1478
250	1999 - 02	LT-F250F (Except Ozark)	525.1108	525.1299
250	1997 - 98	LT-F4WD 250	525.1108	525.1299
250	2004 - 09	LT-Z250	525.1042	525.1478
300	1987 - 89	LT-300E	525.1043	525.1331
300	1991 - 02	LT-F4WDX King Quad 300	525.1108	525.1299
400	2002 - 13	LT-A400 / LT-F400 2x4/4x4 King Quad / Eiger	525.1108	525.1293
450	2007 - 10	LTA-450 X King Quad	525.1538	525.1537
500	2000 - 01	LT-A500F Quad Master Auto	525.1108	525.1293
500	2002 - 07	LT-A500F Vinson	525.1108	525.1293
500	2009 - 11	LT-A500X	525.1538	525.1537
500	2001	LT-F500F Quad Master	525.1108	525.1293
500	1998 - 99	LT-F500F Quad Runner	525.1108	525.1293
500	2002 - 07	LT-F500F Vinson	525.1108	525.1293
700	2005 - 07	LTA-700 X King Quad	525.1538	525.1537
700	2004 - 06	LTV-700F Twin Peaks	525.1497	
750	2008 - 13	LTA-750 X King Quad	525.1538	525.1537



BEARINGS WHEEL/SEAL KITS



Yamaha

Engine	Year	Description	Front Wheel Bearing Kit	Rear Wheel Bearing Kit
50	2004 - 08	YFM50 Raptor	525.1052	525.1109
80	1985 - 86	YFM80	525.1104	525.1397
80	1987 - 88	YFM80	525.1052	525.1397
80	1992 - 01	YFM80 Badger	525.1052	525.1109
80	2005 - 08	YFM80 Grizzly	525.1052	525.1109
80	2002 - 08	YFM80 Raptor	525.1052	525.1109
90	2009 - 13	YFM90 Raptor	525.1613	525.1579
100	1987 - 88	YFM100	525.1052	525.1397
100	1989 - 91	YFM100	525.1052	525.1109
125	1991 - 04	YFA1	525.1052	525.1314
125	2004 - 12	YFM125 Grizzly	525.1052	525.1314
125	2011 - 12	YFM125 Raptor	525.1044	525.1508
200	1985	YFM200 Moto-4	525.1064	525.1011
200	1983 - 05	YTM200 EK	525.1060	525.1011
200	1983	YTM200 K	525.1060	525.1131
200	1984	YTM200L / N	525.1104	525.1131
225	1986 - 88	YFM225 Moto-4	525.1064	525.1011
225	1983 - 86	YTM225 Tri-Moto DXL	525.1104	525.1011
250	1992 - 94	YFB250 Timberwolf	525.1048	525.1134
250	1995 - 98	YFB250 Timberwolf	525.1044	525.1134
250	1994 - 00	YFB250FW Timberwolf	525.1108	525.1134
250	1999	YFM250 Beartracker	525.1226	525.1014
250	2000	YFM250 Beartracker	525.1226	525.1139
250	2001 - 04	YFM250 Beartracker	525.1044	525.1139
250	2007 - 09	YFM250 Big Bear	525.1044	525.1139
250	1989 - 91	YFM250 Moto-4	525.1044	525.1010
250	2005 - 06	YFM250B Bruin	525.1044	525.1139
300	2012 - 13	YFM300 Grizzly	525.1566	525.1124
350	2007 - 11	YFM350 Grizzly IRS	525.1108	525.1496
350	2004 - 06	YFM350B / A Bruin 2WD	525.1108	525.1139
350	1987 - 89	YFM350ER Moto-4	525.1064	525.1010
350	1990 - 95	YFM350ER Moto-4	525.1044	525.1010
350	2004 - 06	YFM350FA Bruin 4WD	525.1108	525.1139
350	2007 - 14	YFM350FGW Grizzly 4WD	525.1108	525.1139
350	1987 - 95	YFM350FW Big Bear	525.1108	525.1010
350	1996 - 97	YFM350FW Big Bear	525.1108	525.1014
350	1998 - 99	YFM350FW Big Bear	525.1108	525.1014
350	2007 - 11	YFM350GW Grizzly 2WD	525.1108	525.1139

BEARINGS WHEEL/SEAL KITS



Bearings

Braking

Bullbars

Cables

Carburettor

Driveline

Electrical

Exhausts



Yamaha (continued)

Engine	Year	Description	Front Wheel Bearing Kit	Rear Wheel Bearing Kit
350	1996 - 99	YFM350U Big Bear	525.1108	525.1014
350	1995 - 99	YFM35FX Wolverine	525.1108	525.1017
350	2000 - 05	YFM35FX Wolverine	525.1108	525.1018
350	2006 - 09	YFM35X Wolverine	525.1108	525.1139
400	2000 - 04	YFM400 Big Bear 2WD	525.1108	525.1139
400	2000 - 06	YFM400 Big Bear 4WD	525.1108	525.1139
400	2007 - 12	YFM400 Big Bear IRS	525.1108	525.1496
400	2007 - 08	YFM400 Grizzly IRS	525.1108	525.1496
400	2000 - 01	YFM400 Kodiak 2WD	525.1108	525.1012
400	2003 - 04	YFM400 Kodiak 2WD	525.1108	525.1139
400	1993 - 99	YFM400 Kodiak 4WD	525.1108	525.1015
400	2000 - 02	YFM400 Kodiak 4WD	525.1108	525.1012
400	2003 - 04	YFM400 Kodiak 4WD	525.1108	525.1139
400	2005 - 06	YFM400 Kodiak 4WD	525.1108	525.1496
450	2007 - 14	YFM450 Grizzly IRS	525.1108	525.1496
450	2003 - 04	YFM450 Kodiak	525.1108	525.1012
450	2005 - 06	YFM450 Kodiak	525.1108	525.1496
450	2006 - 10	YFM45FX Wolverine 450 4X4	525.1108	525.1567
550	2009 - 14	YFM550 Grizzly / EPS	525.1496	525.1496
600	1998	YFM600 Grizzly	525.1108	525.1014
600	1999 - 01	YFM600 Grizzly	525.1108	525.1139
660	2002	YFM660 Grizzly	525.1408	525.1409
660	2003 - 08	YFM660 Grizzly	525.1496	525.1496
700	2007 - 14	YFM700 Grizzly / EPS	525.1496	525.1496
450	2006 - 09	450RHINO	525.1108	525.1542
660	2004 - 07	660 RHINO	525.1108	525.1542
700	2008 - 11	700 RHINO FI	525.1108	525.1542
700	2012 - 13	700 RHINO FI	525.1108	525.1542
700	2004 - 06	700PROHAULER	525.1543	
1000	2004 - 05	1000PROHAULER	525.1543	

REAR RING & PINION GEARS / SETS



Honda

ATV City P/N	Description	Model Fitment	Oem Ref
128.0030	Ring Et Pinion Set	TRX300 88-00 TRX300FW 88-00	41310-HM5-A10
128.0070	Ring Gear	TRX400FW 95-01 TRX450 S / ES 98-01 TRX450 FM / FE 02-04 TRX500FA Rubicon 01-04	41310-HM7-000 (Crown Wheel Only)
128.0050	Pinion - Rear	TRX420 FE / FM / TE / TM 07-13	41421-HP5-600
128.0200	Ring Gear - Rear	TRX420 FE / FM / TE / TM 07-13	41431-HP5-600

Suzuki

ATV City P/N	Description	Model Fitment	Oem Ref
128.0110	Ring Gear	LTF250 Ozark 02-12 LTZ250 04-09	27321-05GA0



(Sample picture)

Bearings

Braking

Bullbars

Cables

Carburettor

Driveline

Electrical

Exhausts

DIFFERENTIAL KITS



Arctic Cat

Engine	Year	Description	Front Differential Bearing and Seal Kit	Rear Differential Bearing and Seal Kit
250	2001 - 02	250 4x4	525.2022	
250	2003	250 4x4	525.2042	
250	2004 - 05	250 4x4	525.2049	
300	1998 - 01	300 4x4	525.2022	
300	2002 - 03	300 4x4	525.2042	
300	2004	300 4x4	525.2050	
300	2005	300 4x4	525.2049	
366	2008 - 11	366 FIS w/AT	525.2050	525.2050
375	2002	375 2x4 w/AT		525.2043
375	2002	375 4x4 w/AT	525.2042	525.2043
400	1998 - 01	400 2x4		525.2041
400	2003	400 2x4 FIS w/AT		525.2043
400	2004	400 2x4 FIS w/AT w/MT		525.2050
400	2003	400 2x4 FIS w/MT		525.2042
400	1998 - 00	400 4x4	525.2022	525.2041
400	2003	400 4x4 w/AT	525.2042	525.2043
400	2004	400 4x4 w/AT w/MT	525.2049	525.2043
400	2001	400 4x4 w/MT	525.2022	525.2041
400	2002 - 03	400 4x4 w/MT	525.2042	525.2043
400	2009 - 11	400 FIS 4x4 TRV	525.2051	525.2050
400	2003	400 FIS 4x4 w/AT	525.2042	525.2042
400	2004	400 FIS 4x4 w/AT	525.2049	525.2050
400	2005 - 08	400 FIS 4x4 w/AT	525.2051	525.2050
400	2002 - 03	400 FIS 4x4 w/MT	525.2042	525.2042
400	2004	400 FIS 4x4 w/MT	525.2049	525.2050
400	2005 - 08	400 FIS 4x4 w/MT	525.2051	525.2050
400	2004	400 TBX 4x4	525.2049	525.2050
400	2005 - 06	400 TBX 4x4	525.2050	525.2050
400	2007	400 TRV	525.2050	525.2050
400	2006	400 VP 4x4	525.2050	525.2043
450	2010 - 11	450 H1	525.2051	525.2050
454	1997 - 98	454 2x4		525.2041
454	1996 - 98	454 4x4	525.2022	525.2041
500	1998 - 99	500 4x4	525.2022	525.2041
500	2000 - 01	500 4x4 w/AT / w/MT	525.2022	525.2041
500	2002	500 4x4 w/AT	525.2042	525.2043

Bearings

Braking

Bullbars

Cables

Carburettor

Driveline

Electrical

Exhausts

DIFFERENTIAL KITS



Arctic Cat (continued)

Engine	Year	Description	Front Differential Bearing and Seal Kit	Rear Differential Bearing and Seal Kit
500	2002 - 03	500 FIS 4x4 w/AT	525.2042	525.2042
500	2004	500 FIS 4x4 w/AT / w/MT	525.2049	525.2050
500	2005 - 09	500 FIS 4x4 w/AT / w/MT	525.2051	525.2050
500	2002	500 FIS 4x4 w/MT	525.2042	525.2042
500	2002	500 FIS TBX 4x4	525.2042	525.2043
500	2003	500 FIS TBX 4x4	525.2042	525.2042
500	2004	500 FIS TBX 4x4	525.2049	525.2050
500	2005 - 06	500 FIS TBX 4x4	525.2051	525.2050
500	2003	500 FIS TRV 4x4	525.2042	525.2042
500	2004	500 FIS TRV 4x4	525.2049	525.2050
500	2005 - 06	500 FIS TRV 4x4	525.2051	525.2050
500	2008	500 FIS TRV 4x4	525.2050	525.2050
550	2009 - 13	550 GT / H1 / TRV EFI 4X4	525.2051	525.2050
650	2004 - 12	650 4x4 H1 / V2	525.2051	525.2050
700	2008 - 11	700 Diesel	525.2051	525.2050
700	2007 - 13	700 EFI 4x4 / H1 / GT / TRV	525.2051	525.2050
1000	2012 - 13	1000i GT/TRV/XT	525.2051	525.2072
1000	2010 - 11	H2 MUDPRO	525.2051	525.2072
1000	2008 - 11	H2 THUNDERCAT	525.2051	525.2072
550	2009 - 13	550 Prowler XT & EFI	525.2051	525.2050
650	2006 - 09	650 Prowler XT	525.2051	525.2050
700	2012	HDX	525.2051	525.2050
700	2008 - 13	700 Prowler XTX & EFI	525.2051	525.2050
1000	2011 - 13	1000 Prowler H2 XTZ & EFI	525.2051	525.2072
1000	2009 - 11	Prowler H2 1000 XTZ	525.2051	

DIFFERENTIAL KITS



Can Am

Engine	Year	Description	Front Differential Bearing and Seal Kit	Rear Differential Bearing and Seal Kit
330	2004 - 05	Outlander 330 / 400	525.2069	525.2069
400	2006 - 13	Outlander 400 / 500 / 650 / 800 / 1000	525.2069	525.2068
500	2008 - 09	Renegade 500	525.2069	525.2068
500	2010 - 13	Renegade 500	525.2069	
500	2004 - 05	Traxter 500 / 650	525.2069	
650	2002 - 04	Quest 650	525.2069	
800	2007 - 13	Renegade 800 / 1000	525.2069	525.2068
800	2011 - 13	Commander 800	525.2069	
1000	2011 - 13	Commander 1000	525.2069	
1000	2013	Maverick 1000	525.2069	

Honda

Engine	Year	Description	Front Differential Bearing and Seal Kit	Rear Differential Bearing and Seal Kit
250	1985 - 87	ATC250ES		525.2008
250	1985 - 87	ATC250SX		525.2008
250	1985 - 87	TRX250 Fourtrax		525.2008
250	1997 - 14	TRX250 Recon		525.2009
250	2001 - 14	TRX250EX Sportrax		525.2009
300	1988 - 00	TRX300 Fourtrax 300 2x4		525.2010
300	1988 - 00	TRX300FW Fourtrax 4x4	525.2001	525.2010
350	1987 - 89	TRX350D	525.2002	525.2011
350	2000 - 06	TRX350TE / FM 2wd / 4wd 2000 - 06	525.2003	525.2012
400	2004 - 07	TRX400FA	525.2046	525.2012
400	1995 - 01	TRX400FW Fourtrax Foreman 4X4	525.2004	525.2013
400	2002 - 03	TRX400FW Fourtrax Foreman 4X4	525.2006	525.2014
420	2009 - 14	TRX420 FA	525.2071	525.2067
420	2014	TRX420FE/FM/TE/TM		525.2079
420	2007 - 12	TRX420 FE/TM	525.2071	525.2070
450	1998 - 01	TRX450 S/ES	525.2004	525.2013
450	2002 - 04	TRX450FE/FM	525.2006	525.2014
450	1998 - 01	TRX450S	525.2004	525.2013
500	2001 - 04	TRX500FA	525.2006	525.2014

DIFFERENTIAL KITS



Honda (continued)

Engine	Year	Description	Front Differential Bearing and Seal Kit	Rear Differential Bearing and Seal Kit
500	2005 - 14	TRX500FA	525.2060	525.2061
500	2005 - 11	TRX500FE / FM / TM	525.2060	525.2061
500	2012 - 13	TRX500FE	525.2078	525.2079
500	2012 - 13	TRX500FM	525.2078	525.2079
500	2014	TRX500FE / FM		525.2079
650	2003 - 14	TRX650 / 680 Rincon	525.2060	525.2047

Kawasaki

Engine	Year	Description	Front Differential Bearing and Seal Kit	Rear Differential Bearing and Seal Kit
220	1988 - 11	KLF220 / 250 Bayou		525.2018
300	1986 - 87	KLF300A Bayou		525.2019
300	1988 - 04	KLF300B Bayou		525.2038
300	1989 - 04	KLF300C Bayou 4x4	525.2015	525.2020
300	1999 - 02	KVF300A / B Prairie 4x4	525.2016	525.2021
360	2003 - 13	KVF360A / B / C Prairie 4x4	525.2066	525.2062
400	1993 - 99	KLF400 Bayou	525.2015	525.2020
400	1997 - 98	KVF400A / B Prairie 4x4	525.2016	525.2021
400	1999 - 02	KVF400C Prairie 4x4	525.2016	525.2021
400	1999 - 02	KVF400D Prairie		525.2021
400	2005 - 14	Mule 610 4x4	525.2016	
620	1993-2014	Mule 2510/3010/4010	525.2093	
650	2005 - 13	KVF650 Brute force	525.2066	525.2062
650	2006 - 13	KVF650 I Brute force	525.2066	525.2091
650	2002 - 03	KVF650 Prairie	525.2066	525.2062
700	2004 - 09	KFX 700 V-Force		525.2062
700	2004 - 06	KVF700 Prairie	525.2066	525.2062
750	2005 - 14	KVF750 Brute Force	525.2066	525.2091
750	2008-13	Teryx 750 4x4	525.2094	525.2095
950	2000-13	Mule 2510/3010/4010	525.2093	

DIFFERENTIAL KITS



Polaris

Engine	Year	Description	Front Differential Bearing and Seal Kit	Rear Differential Bearing and Seal Kit
250	2000 - 02	Xplorer 250 4X4	525.2054	
300	2006 - 07	Hawkeye 4x4 / 2x4	525.2065	525.2090
300	2008 - 10	Sportsman 300 4X4	525.2065	525.2090
325	2000 - 02	Magnum 325 2x4 / 4x4		525.2056
325	2001 - 02	Magnum 325 4x4 HDS	525.2058	525.2056
325	2000 - 02	Xpedition 325	525.2053	525.2056
330	2004 - 05	ATP 330 4X4	525.2059	
330	2003 - 05	Magnum 330 2x4		525.2057
330	2003 - 05	Magnum 330 4x4	525.2059	525.2057
335	1999 - 00	Sportsman 335	525.2054	
335	1999	Worker 335	525.2054	
400	2001 - 03	Sportsman 400 4x4	525.2054	
400	2005	Sportsman 400 4X4	525.2059	525.2089
400	2004	Sportsman 400 4x4 AA AE AG	525.2054	
400	2004	Sportsman 400 4X4 AQ-AV	525.2059	525.2089
400	2008 - 10	Sportsman 400 HO 4x4	525.2065	525.2090
400	1999 - 02	Xplorer 400L 4x4	525.2054	
400	2011 - 14	Sportsman 400 HO 4X4	525.2065	525.2087
425	2000 - 02	Xpedition 425	525.2053	525.2056
450	2006	Sportsman 450	525.2059	
450	2007	Sportsman 450	525.2065	
455	2000 - 01	Diesel 455 4x4	525.2054	
455	1999	Diesel 455 4x4 (after 9/98)	525.2054	
455	1999	Diesel 455 4x4 (before 9/98)	525.2055	
500	2004 - 05	ATP 500 4X4	525.2059	
500	2002	ATV 500 Pro	525.2058	525.2056
500	2002	Magnum 500 2x4 HDS		525.2056
500	1999 - 01	Magnum 500 4x4	525.2053	525.2056
500	2002	Magnum 500 4x4	525.2059	525.2056
500	2001 - 02	Magnum 500 4x4 HDS	525.2058	525.2056
500	2003	Magnum 500 4x4 HDS	525.2058	525.2057
500	2003	PTV Series 10 4x4	525.2058	525.2056
500	1998	Scrambler 500 4x4	525.2055	
500	1999 - 09	Scrambler 500 4x4	525.2054	
500	2010 - 12	Scrambler 500 4x4	525.2065	525.2092

DIFFERENTIAL KITS



Polaris (continued)

Engine	Year	Description	Front Differential Bearing and Seal Kit	Rear Differential Bearing and Seal Kit
500	1998	Sportsman 500 4x4	525.2055	
500	2000	Sportsman 500 4x4	525.2054	
500	1999	Sportsman 500 4x4 (after 9/98)	525.2054	
500	1999	Sportsman 500 4x4 (before 9/98)	525.2055	
500	2001 - 02	Sportsman 500 4x4 DUSE	525.2054	
500	2001 - 04	Sportsman 500 4x4 HO	525.2054	
500	2005 - 06	Sportsman 500 4x4 HO	525.2059	525.2089
500	2007 - 10	Sportsman 500 4x4 HO	525.2065	525.2089
500	2004	Sportsman 500 4x4 HO AA- AC- AE- AG	525.2054	
500	2004	Sportsman 500 4x4 HO AO - AW	525.2059	
500	2000 - 02	Sportsman 500 4x4 RSE	525.2054	
500	1999	Sportsman 500 4x4 RSE (after 9/98)	525.2054	
500	1999	Sportsman 500 4x4 RSE (before 9/98)	525.2055	
500	2009 - 10	Sportsman 500 EFI	525.2065	
500	2008 - 11	Sportsman 500 HO	525.2065	
500	2006 - 09	Sportsman 500 X2	525.2065	
500	2011 - 13	Sportsman Forest 500	525.2065	525.2087
500	2008 - 13	Sportsman Touring 500 EFI	525.2065	525.2084
500	2000 - 02	Worker 500 4x4	525.2054	
500	1999	Worker 500 4x4 (after 9/98)	525.2054	
500	1999	Worker 500 4x4 (before 9/98)	525.2055	
500	1997	Xplorer 500	525.2055	
500	2012 - 13	Sportsman 500 4X4 HO	525.2065	525.2087
550	2010 - 14	Sportsman 550 EPS / X2	525.2076	525.2080
550	2009 - 10	XP 550 Built after 12/1/08	525.2076	525.2080
550	2009	XP 550 Built before 12/1/08	525.2076	525.2081
570	2014	Sportsman 570		525.2087
600	2003 - 04	Sportsman 600 4x4	525.2059	525.2056
600	2005	Sportsman 600 4X4	525.2059	525.2057
700	2002 - 04	Sportsman 700 4x4	525.2059	525.2056
700	2005 - 07	Sportsman 700 Twin	525.2059	525.2057
700	2007	Sportsman 700 Twin EFI	525.2065	525.2057
700	2005	Sportsman MV7	525.2059	525.2057

DIFFERENTIAL KITS



Bearings

Braking

Bullbars

Cables

Carburettor

Driveline

Electrical

Exhausts



Polaris (continued)

Engine	Year	Description	Front Differential Bearing and Seal Kit	Rear Differential Bearing and Seal Kit
700	2008	Sportsman X2 700 Twin EFI	525.2059	525.2084
800	2005 - 06	Sportsman 800 EFI	525.2059	525.2057
800	2008 - 09	Sportsman 800 EFI BUILT 31/1/08 AND BEFORE	525.2065	525.2057
800	2009 - 10	Sportsman 800 EFI	525.2065	525.2096
800	2008 - 09	Sportsman Touring 800 EFI	525.2065	525.2084
800	2007 - 09	Sportsman X2 800 EFI	525.2065	525.2084
800	2011 - 13	Sportsman 800 EFI	525.2065	525.2087
850	2013 - 14	Scrambler HO / XP		525.2080
850	2011 - 14	Sportsman Forest 850	525.2076	525.2080
850	2010 - 14	Sportsman Touring EPS 850	525.2076	525.2080
850	2011	Sportsman X2 850	525.2076	525.2080
850	2010 - 14	Sportsman XP 850, Sportsman XP 850 EPS	525.2076	
0	2011	LSV ELECTRIC 4X4	525.2059	
0	2010 - 13	RANGER EV 4X4	525.2059	
400	2010 - 14	Ranger 4x4 400	525.2065	
500	2001 - 03	Big Boss 500 6x6	525.2054	
500	2004 - 08	Ranger 4x4 500	525.2059	
500	2010 - 13	Ranger 4x4 500 Et CREW	525.2065	525.2084
500	2002 - 04	Ranger 6X6 500	525.2059	
500	2007	Ranger Series 10 / 11 4x4 Et 6x6	525.2059	
500	2000 - 08	Sportsman 500 6x6	525.2054	
700	2005 - 06	Ranger 4x4 700	525.2059	525.2083
700	2009	Ranger 4x4 700	525.2065	525.2082
700	2008 - 09	Ranger 4x4 700 Et CREW	525.2059	525.2082
700	2006 - 09	Ranger 6x6 700 EFI	525.2059	
800	2010 - 14	Ranger 4x4 800 EFI Et CREW	525.2065	525.2084
800	2010 - 14	RANGER 6X6 800	525.2065	525.2082
800	2011 - 14	RANGER RZR 4/EPS RGE	525.2075	525.2088
800	2009 - 10	RANGER RZR S 800	525.2077	525.2088
800	2011 - 14	RANGER RZR S 800	525.2075	525.2088
800	2012	RANGER XP 800	525.2065	525.2084
800	2008 - 10	RZR 800	525.2077	525.2088
800	2011 - 13	RZR 800	525.2077	525.2088

DIFFERENTIAL KITS



Polaris (continued)

Engine	Year	Description	Front Differential Bearing and Seal Kit	Rear Differential Bearing and Seal Kit
800	2009 - 13	Sportsman 800 EFI 6x6	525.2065	525.2096
900	2011 - 14	Ranger 4x4 900 D	525.2075	525.2082
900	2011 - 14	Ranger 4x4 CREW DIESEL 900 D	525.2075	525.2082
900	2011 - 14	Ranger RZR XP 900	525.2075	525.2085

Suzuki

Engine	Year	Description	Front Differential Bearing and Seal Kit	Rear Differential Bearing and Seal Kit
230	1986 - 87	LT-F230		525.2023
250	1987 - 98	LT-4WD 250	525.2022	
250	2002 - 12	LT-F250 Ozark		525.2048
250	1999 - 02	LT-F250F (Except Ozark)	525.2022	
250	1997 - 98	LT-F4WD 250	525.2022	
250	2004 - 09	LT-Z250		525.2048
300	1991 - 99	LT-F4WDX King Quad 300	525.2022	
500	2000	LT-A500F Quad Master Auto	525.2022	525.2041
500	2001	LT-A500F Quad Master Auto	525.2022	525.2064
500	2000	LT-F500F Quad Master	525.2022	525.2041
500	2001	LT-F500F Quad Master	525.2022	525.2064
500	1998 - 00	LT-F500F Quad Runner	525.2022	525.2041
500	2002	LT-F500F Vinson	525.2022	525.2064
700	2004 - 06	LTV-700F Twin Peaks	525.2066	525.2062

DIFFERENTIAL KITS



Yamaha

Engine	Year	Description	Front Differential Bearing and Seal Kit	Rear Differential Bearing and Seal Kit
225	1986 - 88	YFM225 Moto-4		525.2030
225	1983 - 86	YTM225 Tri-Moto		525.2030
250	1992 - 98	YFB250 Timberwolf		525.2030
250	1994 - 00	YFB250FW Timberwolf	525.2026	525.2030
250	1999 - 04	YFM250 Beartracker		525.2033
250	2007 - 09	YFM250 Big Bear		525.2033
250	1989 - 91	YFM250 Moto-4		525.2030
250	2005 - 06	YFM250B Bruin		525.2033
350	2007 - 11	YFM350 Grizzly IRS	525.2073	
350	2004 - 06	YFM350A / B Bruin 2WD		525.2033
350	1987 - 95	YFM350ER Moto-4		525.2030
350	2004 - 06	YFM350FA Bruin 4WD	525.2028	525.2033
350	2007 - 12	YFM350FGW Grizzly 4WD	525.2028	525.2033
350	1987 - 95	YFM350FW Big Bear	525.2026	525.2030
350	1996 - 97	YFM350FW Big Bear	525.2026	525.2033
350	1998 - 99	YFM350FW Big Bear	525.2001	525.2033
350	2007 - 11	YFM350GW Grizzly 2WD		525.2033
350	1996 - 99	YFM350U Big Bear		525.2033
350	1995 - 97	YFM35FX Wolverine	525.2027	525.2033
350	1998 - 05	YFM35FX Wolverine	525.2001	525.2033
350	2006 - 09	YFM35X Wolverine		525.2033
400	2000 - 04	YFM400 Big Bear 2WD		525.2033
400	2000 - 01	YFM400 Big Bear 4WD	525.2001	525.2033
400	2002 - 06	YFM400 Big Bear 4WD	525.2028	525.2033
400	2007 - 12	YFM400 Big Bear IRS	525.2073	
400	2007 - 08	YFM400 Grizzly IRS	525.2028	
400	2000 - 04	YFM400 Kodiak 2WD		525.2033
400	1993 - 98	YFM400 Kodiak 4WD	525.2026	525.2033
400	1999	YFM400 Kodiak 4WD	525.2001	525.2033
400	2000 - 04	YFM400 Kodiak 4WD	525.2028	525.2033
400	2005 - 06	YFM400 Kodiak 4WD	525.2028	
450	2007	YFM450 Grizzly IRS	525.2044	
450	2008 - 14	YFM450 Grizzly IRS	525.2073	
450	2003 - 04	YFM450 Kodiak	525.2044	525.2033
450	2005 - 06	YFM450 Kodiak	525.2044	

Bearings

Braking

Bullbars

Cables

Carburettor

Driveline

Electrical

Exhausts

DIFFERENTIAL KITS



Yamaha

Engine	Year	Description	Front Differential Bearing and Seal Kit	Rear Differential Bearing and Seal Kit
450	2006 - 10	YFM45FX Wolverine 450 4X4	525.2028	525.2033
550	2009 - 14	YFM550 Grizzly / EPS	525.2073	525.2074
600	1998 - 01	YFM600 Grizzly	525.2029	525.2033
660	2002 - 08	YFM660 Grizzly	525.2044	525.2045
700	2007 - 14	YFM700 Grizzly / EPS	525.2073	525.2074
450	2006 - 09	450RHINO	525.2044	525.2045
660	2004 - 07	660 RHINO	525.2044	525.2045
700	2008 - 11	700 RHINO FI	525.2073	525.2045
700	2012 - 13	700 RHINO FI	525.2073	525.2045

DIFF SEAL KITS



Arctic Cat - ATV

Model No	Year	Front Differential Seal Only Kit	Rear Differential Seal Only Kit
250 4x4	2001 - 02	525.2022-5	
300 4x4	1998 - 01	525.2022-5	
300 4x4	2004	525.2050-5	
366 FIS w/AT	2008 - 11	525.2050-5	525.2050-5
400 4x4	1998 - 00	525.2022-5	
400 4x4 w/MT	2001	525.2022-5	
400 FIS 2x4 w/AT - w/MT	2004		525.2050-5
400 FIS 4x4 TRV	2009 - 12	525.2051-5	525.2050-5
400 FIS 4x4 TRV	2013		525.2050-5
400 FIS 4x4 w/AT	2004		525.2050-5
400 FIS 4x4 w/AT - w/MT	2005 - 08	525.2051-5	525.2050-5
400 TBX 4x4	2004		525.2050-5
400 TBX 4x4	2005 - 06	525.2050-5	525.2050-5
400 TRV	2007	525.2050-5	525.2050-5
400 VP 4x4	2006	525.2050-5	
425 4x4	2011 - 12	525.2051-5	525.2050-5
450 H1	2010 - 11	525.2051-5	525.2050-5
450i TRV EFI / GT	2012	525.2051-5	525.2050-5
550 TRV XT	2013	525.2051-5	525.2050-5
454 4x4	1996 - 98	525.2022-5	
500 4x4 w/MT - w/AT	1998 - 01	525.2022-5	
500 EFI	2013		525.2050-5
500 FIS 4x4 w/AT - w/MT	2004		525.2050-5
500 FIS 4x4 w/AT - w/MT	2005 - 09	525.2051-5	525.2050-5
500 FIS TBX / TRV 4x4	2004		525.2050-5
500 FIS TBX / TRV 4x4	2005 - 06	525.2051-5	525.2050-5
500 FIS TRV 4x4	2008	525.2050-5	525.2050-5
500 TRV	2013		525.2050-5
500 XT EFI	2013	525.2051-5	525.2050-5
550 EFI 4X4	2013	525.2051-5	525.2050-5
550 GT EFI 4X4	2012	525.2051-5	525.2050-5
550 H1 FIS 4X4	2009 - 11	525.2051-5	525.2050-5
550 i EFI 4X4	2012	525.2051-5	525.2050-5
550 TRV 4X4	2013	525.2051-5	525.2050-5
550 TRV 4x4 w/AT	2009 - 11	525.2051-5	525.2050-5

Arctic Cat - ATV Cont.

Model No	Year	Front Differential Seal Only Kit	Rear Differential Seal Only Kit
550 XT EFI 4X4	2013	525.2051-5	525.2050-5
550i TRV GT EFI 4X4	2012	525.2051-5	525.2050-5
650 4x4 H1	2005 - 11	525.2051-5	525.2050-5
650 4x4 H1 Mud Pro	2010 - 11	525.2051-5	525.2050-5
650 4x4 w/AT V2	2004 - 06	525.2051-5	525.2050-5
650i 4x4	2012	525.2051-5	525.2050-5
700 EFI 4x4	2007 - 12	525.2051-5	525.2050-5
700 EFI H1 MUDPRO	2009 - 11	525.2051-5	525.2050-5
700 EFI H1 w/AT	2008 - 11	525.2051-5	525.2050-5
700 GT EFI	2012	525.2051-5	525.2050-5
700 H1 TRV	2008 - 11	525.2051-5	525.2050-5
700 LTD EFI	2013	525.2051-5	525.2050-5
700 XT	2013	525.2051-5	525.2072-5
700i Diesel EFI	2008 - 13	525.2051-5	525.2050-5
700i EFI MUDPRO	2012 - 13	525.2051-5	525.2050-5
700i TRV Cruiser EFI	2012	525.2051-5	525.2050-5
700i TRV GT EFI	2012	525.2051-5	525.2050-5
1000 Cruiser	2012	525.2051-5	525.2072-5
1000 TRV GT	2012	525.2051-5	525.2072-5
1000 TRV LTD	2013	525.2051-5	525.2072-5
1000 XT	2013	525.2051-5	525.2072-5
1000i GT	2012	525.2051-5	525.2072-5
1000i LDT EFI MUDPRO	2012 - 13	525.2051-5	525.2072-5
H2 MUDPRO	2010 - 11	525.2051-5	525.2072-5
H2 THUNDERCAT	2008 - 11	525.2051-5	525.2072-5

Arctic Cat - UTV

Model No	Year	Front Differential Seal Only Kit	Rear Differential Seal Only Kit
550 Prowler XT	2009 - 13	525.2050-5	525.2050-5
650 Prowler XT	2006 - 09	525.2050-5	525.2050-5
700 Prowler HDX	2012	525.2050-5	525.2050-5
700 Prowler XTX	2008 - 12	525.2050-5	525.2050-5
1000 Prowler XTZ	2011 - 13	525.2050-5	525.2072-5
Prowler H2 1000 XTZ	2009 - 11	525.2050-5	525.2072-5

DIFF SEAL KITS



Can-Am ATV

Model No	Year	Front Differential Seal Only Kit	Rear Differential Seal Only Kit
Outlander 330	2004 - 05	525.2069-5	525.2069-5
Outlander 400	2003 - 05	525.2069-5	525.2069-5
Outlander 400	2006 - 11	525.2069-5	525.2068-5
Outlander 400	2012 - 13	525.2069-5	525.2086-5
Outlander 500	2007 - 11	525.2069-5	525.2068-5
Outlander 500	2012 - 13	525.2069-5	525.2086-5
Outlander 500 Power Steering	2010 - 11	525.2069-5	525.2068-5
Outlander 500 Power Steering	2012	525.2069-5	525.2086-5
Renegade 500	2008 - 11	525.2069-5	525.2068-5
Renegade 500	2012 - 13	525.2069-5	525.2086-5
Renegade 500 Power Steering	2012	525.2069-5	525.2086-5
Traxter 500	1999 - 05	525.2069-5	
Outlander 650	2007 - 11	525.2069-5	525.2068-5
Outlander 650	2012 - 13	525.2069-5	525.2086-5
Outlander 650 Power Steering	2010 - 11	525.2069-5	525.2068-5
Outlander 650 Power Steering	2012	525.2069-5	525.2086-5
Quest 650	2002 - 04	525.2069-5	
Traxter 650	2004 - 05	525.2069-5	
Outlander 800	2006 - 11	525.2069-5	525.2068-5
Outlander 800	2013	525.2069-5	525.2086-5
Outlander 800 Power Steering	2010 - 11	525.2069-5	525.2068-5
Outlander 800 Power Steering-MAX	2012	525.2069-5	525.2086-5
Outlander 800 Xmr-MAX	2012	525.2069-5	525.2086-5
Outlander STD XT 800R	2012	525.2069-5	525.2086-5
Renegade 800	2007 - 11	525.2069-5	525.2068-5
Renegade 800	2012 - 13	525.2069-5	525.2086-5
Renegade 800 Power Steering	2010 - 11	525.2069-5	525.2068-5
Outlander 1000	2013	525.2069-5	525.2086-5
Outlander STD XT 1000	2012	525.2069-5	525.2086-5
Renegade 1000	2012 - 13	525.2069-5	525.2086-5

Can-Am UTV

Model No	Year	Front Differential Seal Only Kit	Rear Differential Seal Only Kit
Commander 800	2011 - 12	525.2069-5	
Commander 800	2013	525.2069-5	525.2086-5
Commander 1000	2011 - 12	525.2069-5	
Commander 1000	2013	525.2069-5	525.2086-5

Honda - ATV

Model No	Year	Front Differential Seal Only Kit	Rear Differential Seal Only Kit
TRX250 Recon	1997 - 13		525.2009-5
TRX250EX Sportrax	2001 - 12		525.2009-5
TRX300 Fourtrax 300	1988 - 00		525.2010-5
TRX300FW Fourtrax 4x4	1988 - 00	525.2001-5	525.2010-5
TRX350FE/FM/TM/TE	2000 - 06	525.2003-5	525.2012-5
TRX400FA/FGA	2004 - 07		525.2012-5
TRX400FW Fourtrax Foreman 4X4	1995 - 01	525.2004-5	525.2013-5
TRX400FW Fourtrax Foreman 4X4	2002 - 03	525.2006-5	525.2014-5
TRX420 FA/FPA	2009 - 13	525.2071-5	525.2067-5
TRX420 FE/FM	2007 - 13	525.2071-5	525.2070-5
TRX420 FPE/FPM	2011 - 13	525.2071-5	525.2070-5
TRX420 TE/TM	2007 - 10		525.2070-5
TRX450ES	1998 - 01	525.2004-5	525.2013-5
TRX450FE/FM	2002 - 04	525.2006-5	525.2014-5
TRX450S	1998 - 01	525.2004-5	525.2013-5
TRX500FA	2001 - 04	525.2006-5	525.2014-5
TRX500FA	2005 - 13	525.2060-5	525.2061-5
TRX500FE	2005 - 11	525.2060-5	525.2061-5
TRX500FGA	2004	525.2060-5	525.2014-5
TRX500FGA	2005 - 09	525.2060-5	525.2061-5
TRX500FM	2005 - 11	525.2060-5	525.2061-5
TRX500FPA	2009 - 13	525.2060-5	525.2061-5
TRX500FPE/FPM	2008 - 11	525.2060-5	525.2061-5
TRX500TM	2005 - 06		525.2061-5
TRX650 Rincon	2003 - 05	525.2060-5	525.2047-5
TRX680 Rincon	2006 - 13	525.2060-5	525.2047-5

DIFF SEAL KITS



Can-Am UTV

Model No	Year	Front Differential Seal Only Kit	Rear Differential Seal Only Kit
Commander 800	2011 - 12	525.2069-5	
Commander 800	2013	525.2069-5	525.2086-5
Commander 1000	2011 - 12	525.2069-5	
Commander 1000	2013	525.2069-5	525.2086-5

Honda - ATV

Model No	Year	Front Differential Seal Only Kit	Rear Differential Seal Only Kit
TRX250 Recon	1997 - 13		525.2009-5
TRX250EX Sportrax	2001 - 12		525.2009-5
TRX300 Fourtrax 300	1988 - 00		525.2010-5
TRX300FW Fourtrax 4x4	1988 - 00	525.2001-5	525.2010-5
TRX350FE/FM/TM/TE	2000 - 06	525.2003-5	525.2012-5
TRX400FA/FGA	2004 - 07		525.2012-5
TRX400FW Fourtrax Foreman 4X4	1995 - 01	525.2004-5	525.2013-5
TRX400FW Fourtrax Foreman 4X4	2002 - 03	525.2006-5	525.2014-5
TRX420 FA/FPA	2009 - 13	525.2071-5	525.2067-5
TRX420 FE/FM	2007 - 13	525.2071-5	525.2070-5
TRX420 FPE/FPM	2011 - 13	525.2071-5	525.2070-5
TRX420 TE/TM	2007 - 10		525.2070-5
TRX450ES	1998 - 01	525.2004-5	525.2013-5
TRX450FE/FM	2002 - 04	525.2006-5	525.2014-5
TRX450S	1998 - 01	525.2004-5	525.2013-5
TRX500FA	2001 - 04	525.2006-5	525.2014-5
TRX500FA	2005 - 13	525.2060-5	525.2061-5
TRX500FE	2005 - 11	525.2060-5	525.2061-5
TRX500FGA	2004	525.2060-5	525.2014-5
TRX500FGA	2005 - 09	525.2060-5	525.2061-5
TRX500FM	2005 - 11	525.2060-5	525.2061-5
TRX500FPA	2009 - 13	525.2060-5	525.2061-5
TRX500FPE/FPM	2008 - 11	525.2060-5	525.2061-5
TRX500TM	2005 - 06		525.2061-5
TRX650 Rincon	2003 - 05	525.2060-5	525.2047-5
TRX680 Rincon	2006 - 13	525.2060-5	525.2047-5

Kawasaki - ATV

Model No	Year	Front Differential Seal Only Kit	Rear Differential Seal Only Kit
KLF300C Bayou 4X4	1989 - 04		525.2020-5
KVF300A / B Prairie 4x4/2x4	1999 - 02		525.2021-5
KVF360A Et C Prairie 4x4	2003 - 13	525.2066-5	
KLF400 Bayou	1993 - 99		525.2020-5
KVF400A / B / C / D Prairie	1997 - 02		525.2021-5
KVF650 Brute force	2005 - 12	525.2066-5	525.2062-5
KVF650 I Brute force	2006 - 13	525.2066-5	525.2091-5
KVF650 Prairie	2002 - 03	525.2066-5	525.2062-5
KFX 700 V-Force	2004 - 09		525.2062-5
KVF700 Prairie	2004 - 06	525.2066-5	525.2062-5
KVF750 Brute Force / EPS	2005 - 13	525.2066-5	525.2091-5

Polaris - ATV

Model No	Year	Front Differential Seal Only Kit	Rear Differential Seal Only Kit
Magnum 325 2x4 / 4x4 / HDS	2000 - 02		525.2056-5
Xpedition 325	2000 - 02		525.2056-5
ATP 330 4X4	2004 - 05	525.2059-5	
Magnum 330 4x4	2003 - 05	525.2059-5	
Sportsman 400 4X4 / AQ-AV	2004 - 05	525.2059-5	
Xpedition 425	2000 - 02		525.2056-5
Sportsman 450	2006	525.2059-5	
ATP 500 4X4	2004 - 05	525.2059-5	
ATV 500 Pro	2002		525.2056-5
Magnum 500 4x4 / HDS	1999 - 02		525.2056-5
Magnum 500 4x4	2002	525.2059-5	525.2056-5
Magnum 500 4x4 HDS	2001 - 02		525.2056-5
PTV Series 10 4x4	2003		525.2056-5
Sportsman 500 4x4 HO AO - AX	2004	525.2059-5	
Sportsman 500 4x4 HO	2005 - 06	525.2059-5	
Sportsman 600 4x4	2003 - 04	525.2059-5	525.2056-5
Sportsman 600 4X4	2005	525.2059-5	
Sportsman 700 4x4	2002 - 04	525.2059-5	525.2056-5
Sportsman 700 Twin/EFI	2005 - 06	525.2059-5	

DIFF SEAL KITS



Kawasaki - ATV

Model No	Year	Front Differential Seal Only Kit	Rear Differential Seal Only Kit
KLF300C Bayou 4X4	1989 - 04		525.2020-5
KVF300A/B Prairie 4x4/2x4	1999 - 02		525.2021-5
KVF360A Et C Prairie 4x4	2003 - 13	525.2066-5	
KLF400 Bayou	1993 - 99		525.2020-5
KVF400A/B/C/D Prairie	1997 - 02		525.2021-5
KVF650 Brute force	2005 - 12	525.2066-5	525.2062-5
KVF650 I Brute force	2006 - 13	525.2066-5	525.2091-5
KVF650 Prairie	2002 - 03	525.2066-5	525.2062-5
KFX 700 V-Force	2004 - 09		525.2062-5
KVF700 Prairie	2004 - 06	525.2066-5	525.2062-5
KVF750 Brute Force / EPS	2005 - 13	525.2066-5	525.2091-5

Polaris - ATV

Model No	Year	Front Differential Seal Only Kit	Rear Differential Seal Only Kit
Magnum 325 2x4/4x4/HDS	2000 - 02		525.2056-5
Xpedition 325	2000 - 02		525.2056-5
ATP 330 4X4	2004 - 05	525.2059-5	
Magnum 330 4x4	2003 - 05	525.2059-5	
Sportsman 400 4X4/AQ-AV	2004 - 05	525.2059-5	
Xpedition 425	2000 - 02		525.2056-5
Sportsman 450	2006	525.2059-5	
ATP 500 4X4	2004 - 05	525.2059-5	
ATV 500 Pro	2002		525.2056-5
Magnum 500 4x4 / HDS	1999 - 02		525.2056-5
Magnum 500 4x4	2002	525.2059-5	525.2056-5
Magnum 500 4x4 HDS	2001 - 02		525.2056-5
PTV Series 10 4x4	2003		525.2056-5
Sportsman 500 4x4 HO/AO-AX	2004	525.2059-5	
Sportsman 500 4x4 HO	2005 - 06	525.2059-5	
Sportsman 600 4x4	2003 - 04	525.2059-5	525.2056-5
Sportsman 600 4X4	2005	525.2059-5	
Sportsman 700 4x4	2002 - 04	525.2059-5	525.2056-5
Sportsman 700 Twin/EFI	2005 - 06	525.2059-5	

Polaris - ATV Cont.

Model No	Year	Front Differential Seal Only Kit	Rear Differential Seal Only Kit
Sportsman MV7	2005	525.2059-5	
Sportsman X2 700 Twin EFI	2008	525.2059-5	
Sportsman 800 EFI	2005 - 06	525.2059-5	

Polaris - UTV

Model No	Year	Front Differential Seal Only Kit	Rear Differential Seal Only Kit
LSV ELECTRIC 4X4	2011 - 12	525.2059-5	525.2020-5
RANGER EV 4X4	2010 - 12	525.2059-5	525.2021-5
Ranger 4x4 500	2002 - 08	525.2059-5	
Ranger 6X6 500	2002	525.2059-5	525.2020-5
Ranger 6X6 500	2004	525.2059-5	525.2021-5
Ranger Series 10 4x4 Et 6x6	2007	525.2059-5	525.2062-5
Ranger Series 11 4x4 Et 6x6	2007	525.2059-5	525.2091-5
Ranger 4x4 700 / 6x6 / Crew	2005 - 09	525.2059-5	

Suzuki - ATV

Model No	Year	Front Differential Seal Only Kit	Rear Differential Seal Only Kit
LT-4WD 250	1987 - 98	525.2022-5	
LT-F250F (Except Ozark)	1999 - 02	525.2022-5	
LT-F4WD 250	1997 - 98	525.2022-5	
LT-F300F King Quad	1991 - 02	525.2022-5	
LT-A500F Quad Master Auto	2000 - 01	525.2022-5	
LT-F500F	1998 - 02	525.2022-5	
LTV-700F Twin Peaks	2004 - 06	525.2066-5	525.2062-5

DIFF SEAL KITS



Yamaha - ATV

Model No	Year	Front Differential Seal Only Kit	Rear Differential Seal Only Kit
YFB250 / FW Timberwolf	1994 - 00		525.2030-5
YFM250 Beartracker	1999 - 04		525.2033-5
YFM250 Big Bear	2007 - 09		525.2033-5
YFM250B Bruin	2005 - 06		525.2033-5
YFM350 Grizzly 4WD	2013		525.2033-5
YFM350 Grizzly IRS	2007 - 11	525.2044-5	
YFM350BA Bruin 2WD	2004 - 06		525.2033-5
YFM350ER Moto-4	1987 - 95		525.2030-5
YFM350FA Bruin 4WD	2004 - 06	525.2028-5	525.2033-5
YFM350FGW Grizzly 4WD	2007 - 12	525.2028-5	525.2033-5
YFM350FW Big Bear	1987 - 95		525.2030-5
YFM350FW Big Bear	1996 - 97		525.2033-5
YFM350FW Big Bear	1998 - 99	525.2001-5	525.2033-5
YFM350GW Grizzly 2WD	2007 - 11		525.2033-5
YFM350U Big Bear	1996 - 99		525.2033-5
YFM35FX Wolverine	1995 - 97		525.2033-5
YFM35FX Wolverine	1998 - 99	525.2001-5	525.2033-5
YFM35FX Wolverine	2000 - 05	525.2001-5	525.2033-5
YFM35X Wolverine	2006 - 09		525.2033-5
YFM400 Big Bear 2WD	2000 - 04		525.2033-5
YFM400 Big Bear 4WD	2000 - 01	525.2001-5	525.2033-5
YFM400 Big Bear 4WD	2002 - 06	525.2028-5	525.2033-5
YFM400 Big Bear IRS	2007 - 12	525.2044-5	
YFM400 Grizzly IRS	2007 - 08	525.2028-5	
YFM400 Kodiak 2WD	2000 - 04		525.2033-5
YFM400 Kodiak 4WD	1993 - 98		525.2033-5
YFM400 Kodiak 4WD	1999	525.2001-5	525.2033-5
YFM400 Kodiak 4WD	2000 - 04	525.2028-5	525.2033-5
YFM400 Kodiak 4WD	2005 - 06	525.2028-5	
YFM450 Grizzly EPS	2013	525.2044-5	
YFM450 Grizzly IRS	2007	525.2044-5	
YFM450 Grizzly IRS	2008 - 13	525.2044-5	
YFM450 Kodiak	2003 - 04	525.2044-5	525.2033-5
YFM450 Kodiak	2005 - 06	525.2044-5	
YFM45FX Wolverine 450 4X4	2006 - 10	525.2028-5	525.2033-5

Yamaha - ATV Cont.

Model No	Year	Front Differential Seal Only Kit	Rear Differential Seal Only Kit
YFM550 Grizzly/EPS	2009 - 13	525.2044-5	525.2074-5
YFM600 Grizzly	1998 - 01		525.2033-5
YFM600 Grizzly	2002	525.2044-5	525.2045-5
YFM660 Grizzly	2002 - 08	525.2044-5	525.2045-5
YFM700 Grizzly	2007 - 13	525.2044-5	525.2074-5
YFM700 Grizzly EPS	2008 - 13	525.2044-5	525.2074-5

Bearings

Braking

Bullbars

Cables

Carburettor

Driveline

Electrical

Exhausts



SUSPENSION KITS

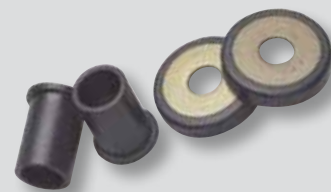

Arctic Cat

Eng	Year	Model No	Lower A-Arm Kit	Upper A-Arm Kit	Rear Independent Suspension Kit	Swing Arm Bearing Kit	Front shock bushing kit	Rear shock bushing kit
250	1999 - 05	250 2x4	550.1039	550.1039	550.1066		521.0001	521.0001
250	2006 - 09	250 2x4	550.1073	550.1073		528.1056		521.0001
250	2001 - 02	250 4x4	550.1039	550.1039	550.1066		521.0001	521.0001
250	2003 - 05	250 4x4	550.1039	550.1039	550.1066		521.0001	521.0001
250	2006 - 08	DVX250	550.1073	550.1073				
300	1998 - 04	300 2x4	550.1039	550.1039	550.1066		521.0001	521.0001
300	2010 - 12	300 2x4	550.1073	550.1073		528.1056		
300	1998 - 05	300 4x4	550.1039	550.1039	550.1066		521.0001	521.0001
300	2009 - 12	DVX300	550.1073	550.1073				
375	2002	375 2x4 w/AT	550.1039	550.1061			521.0001	521.0001
400	1998 - 01	400 2x4	550.1039	550.1039			521.0001	521.0001
400	2003	400 2x4 FIS w/AT - w/MT	550.1039	550.1061	550.1065		521.0001	521.0001
400	2004	400 2x4 FIS w/AT	550.1060	550.1061	550.1064		521.0001	521.0001
400	2004	400 2x4 FIS w/MT	550.1060	550.1061			521.0001	521.0001
400	1998 - 00	400 4x4	550.1039	550.1039			521.0001	521.0001
400	2003 - 04	400 4x4 w/AT	550.1039	550.1061			521.0001	521.0001
400	2001	400 4x4 w/MT	550.1039	550.1039			521.0001	521.0001
400	2002 - 04	400 4x4 w/MT	550.1039	550.1061			521.0001	521.0001
400	2009 - 13	400 FIS 4x4 TRV	550.1060	550.1061	550.1064			
400	2003	400 FIS 4x4 w/AT	550.1039	550.1061	550.1065		521.0001	521.0001
400	2004 - 06	400 FIS 4x4 w/AT	550.1060	550.1061	550.1064		521.0001	521.0001
400	2007 - 08	400 FIS 4x4 w/AT	550.1060	550.1061	550.1064			
400	2002 - 03	400 FIS 4x4 w/MT	550.1039	550.1061	550.1065		521.0001	521.0001
400	2004 - 06	400 FIS 4x4 w/MT	550.1060	550.1061	550.1064		521.0001	521.0001
400	2007 - 08	400 FIS 4x4 w/MT	550.1060	550.1061	550.1064			
400	2004	400 TBX 4x4	550.1039	550.1061	550.1065		521.0001	521.0001
400	2005 - 06	400 TBX 4x4	550.1060	550.1061	550.1064		521.0001	521.0001
400	2007	400 TRV	550.1060	550.1061				
400	2006	400 VP 4x4	550.1039	550.1061			521.0001	521.0001
450	2011 - 12	450 H1	550.1060	550.1061	550.1064			
454	1996 - 98	454 2x4 / 4x4	550.1039	550.1039			521.0001	521.0001
500	1998 - 01	500 4x4 w/MT - w/AT	550.1039	550.1039			521.0001	521.0001
500	2002	500 4x4 w/AT - FIS TBX	550.1039	550.1061			521.0001	521.0001
500	2002 - 03	500 FIS 4x4 w/AT	550.1039	550.1061	550.1065		521.0001	521.0001
500	2004 - 06	500 FIS 4x4 w/AT - w/MT	550.1060	550.1061	550.1064		521.0001	521.0001
500	2007 - 00	500 FIS 4x4 w/AT - w/MT	550.1060	550.1061	550.1064			
500	2002	500 FIS 4x4 w/MT	550.1039	550.1061	550.1065		521.0001	521.0001
500	2003 - 08	500 FIS TBX / TRV 4x4	550.1039	550.1061	550.1065		521.0001	521.0001
500	2013	500 EFI/TRV/XT	550.1060	550.1061	550.1064			
550	2009 - 13	550 H1 FIS / GT / TRV 4X4	550.1060	550.1061	550.1064			
550	2009 - 13	550 Prowler XT & EFI	550.1060	550.1061	550.1064			
650	2006 - 09	650 Prowler XT	550.1060	550.1061	550.1064			
650	2004 - 13	650 4x4 w/AT V2	550.1060	550.1061	550.1064		521.0001	521.0001

SUSPENSION KITS

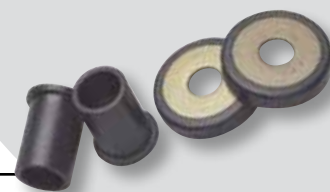

Arctic Cat Cont.

Eng	Year	Model No	Lower A-Arm Kit	Upper A-Arm Kit	Rear Independent Suspension Kit	Swing Arm Bearing Kit	Front shock bushing kit	Rear shock bushing kit
700	2008 - 13	700 Diesel / EFI / GT / H1 TRV / GT	550.1060	550.1061	550.1064			
700	2008 - 13	700 Prowler XTX Et EFI	550.1060	550.1061	550.1064			
700	2012	HDX	550.1060	550.1061				
1000	2010 - 11	H2 MUDPRO	550.1060	550.1061	550.1064			
1000	2008 - 11	H2 THUNDERCAT	550.1060	550.1061	550.1064			
1000	2011 - 13	1000 Prowler H2 XTZ Et EFI	550.1060	550.1061	550.1064			
1000	2009 - 10	Prowler H2 1000 XTZ	550.1060	550.1061				

Can Am

Eng	Year	Model No	Lower A-Arm Kit	Upper A-Arm Kit	Rear Independent Suspension Kit	Swing Arm Bearing Kit	Front shock bushing kit	Rear shock bushing kit
330	2004 - 05	Outlander 330	550.1062		550.1069			
400	2003 - 12	Outlander 400	550.1062		550.1069			
400	2013 - 14	Outlander 400			550.1069			
450	2008 - 14	DS450 STD/X	550.1062	550.1062				
500	2007 - 12	Outlander 500	550.1062		550.1069			
500	2013 - 14	Outlander 500	550.1062	550.1062	550.1080			
500	2002 - 03	Quest 500	550.1062	550.1062		528.1155		
500	2018 - 12	Renegade 500	550.1062	550.1062	550.1069			
500	2013 - 14	Renegade 500	550.1062	550.1062	550.1080			
500	1999 - 00	Traxter 500				528.1155		
500	2001 - 05	Traxter 500	550.1062	550.1062		528.1155		
650	2007 - 12	Outlander 650	550.1062	550.1062	550.1069			
650	2013 - 14	Outlander 650	550.1062	550.1062	550.1080			
650	2002 - 04	Quest 650	550.1062	550.1062		528.1155		
650	2004 - 05	Traxter 650	550.1062	550.1062		528.1155		
800	2006 - 11	Outlander 800	550.1062	550.1062	550.1069			
800	2013 - 14	Outlander 800	550.1062	550.1062	550.1080			
800	2012	Outlander STD XT 800R	550.1062	550.1062	550.1080			
800	2007 - 11	Renegade 800	550.1062	550.1062	550.1069			
800	2012 - 14	Renegade 800	550.1062	550.1062	550.1080			
800	2011 - 13	Commander 800	550.1062		550.1079			
1000	2011 - 13	Commander 1000	550.1062		550.1079			
1000	2013 - 14	Outlander 1000	550.1062	550.1062	550.1080			
1000	2012 - 14	Outlander STD XT 1000	550.1062	550.1062	550.1080			
1000	2012 - 14	Renegade 1000	550.1062	550.1062	550.1080			

Honda

Eng	Year	Model No	Lower A-Arm Kit	Upper A-Arm Kit	Rear Independent Suspension Kit	Swing Arm Bearing Kit	Front shock bushing kit	Rear shock bushing kit
90	1993 - 13	TRX90	550.1038			528.1009		
250	1985 - 87	ATC250ES / SX				528.1056		
250	1985 - 87	TRX250 Fourtrax				528.1056	521.1008	529.5052
250	1997 - 13	TRX250 Recon	100.0010	100.0010		528.1056	521.1008	

SUSPENSION KITS

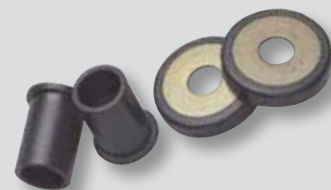

Honda Cont.

Eng	Year	Model No	Lower A-Arm Kit	Upper A-Arm Kit	Rear Independent Suspension Kit	Swing Arm Bearing Kit	Front shock bushing kit	Rear shock bushing kit
250	2001 - 12	TRX250EX Sportrax	100.0010	100.0010		528.1056	521.1008	
300	1988 - 92	TRX300 Fourtrax 300	100.0010			528.1056		
300	1993 - 00	TRX300 Fourtrax 300	100.0010	100.0010		528.1056		
300	1988 - 00	TRX300FW Fourtrax 4x4	100.0010	100.0010		528.1056		
350	2002	TRX350FE / TM Fourtrax Rancher	100.0010	100.0010		528.1056	521.0008	529.5052
350	2006	TRX350 FE/FM	100.0010	100.0010		528.1056	521.1008	521.1011
350	2000 - 01	TRX350FM / TE Fourtrax Rancher	100.0010	100.0010		528.1056	521.1008	
400	2004 - 07	TRX400FA	100.0010	100.0010		528.1056	521.1008	
400	1995 - 03	TRX400FW Fourtrax Foreman 4X4	100.0010	100.0010		528.1056		
420	2009 - 14	TRX420 FA	100.0010	100.0010	550.1068		521.1009	
420	2007 - 13	TRX420 FE/FM/TE/TM	100.0010	100.0010		528.1203	521.1009	521.1010
420	2014	TRX420FE/FM/TE/TM	100.0010	100.0010		528.1211		
450	1998 - 04	TRX450ES / S / FM / FE	100.0010	100.0010		528.1056	521.0007	
500	2001	TRX500FA	100.0010	550.1003		528.1056	529.5053	529.5053
500	2007 - 14	TRX500FA	100.0010	550.1003		528.1056	521.1008	521.1008
500	2005 - 06	TRX500FE / FM	100.0010	550.1003		528.1056	529.5053	529.5053
500	2007	TRX500FE	100.0010	550.1003		528.1056	529.1008	529.5053
500	2008 - 11	TRX500FE / FPE	100.0010	550.1003		528.1056	521.1008	521.1008
500	2012 - 13	TRX500FE / FM / FPE/M	100.0010	550.1003		528.1203	521.1008	521.1011
500	2014	TRX500FE/FM				528.1211		
500	2007 - 11	TRX500FM	100.0010	550.1003		528.1056	521.1008	521.1008
500	2009 - 14	TRX500FPA	100.0010	550.1003		528.1056	521.1008	521.1008
500	2008 - 11	TRX500FPM	100.0010	550.1003		528.1056	521.1008	521.1008
500	2005 - 06	TRX500TM	100.0010	550.1003		528.1056	529.5053	529.5053
650	2003 - 13	TRX650 / 680 Rincon	100.0010	550.1033	550.1035		529.5053	
700	2008 - 09	TRX700XX	550.1020	550.1020				529.5019

Lower Shock Bush Upgrade Kit Part No.

350	00-06	TRX350FE/TM					100.0020	
450	98-04	TRX450S/FM					100.0025	
500	09-12	TRX500FM/FA					100.0030	

Stainless Steel Upgrade Bush for 550.1003

		TRX420 / 500 (Centre tube bush only)		100.0035				
--	--	--	--	----------	--	--	--	--



SUSPENSION KITS

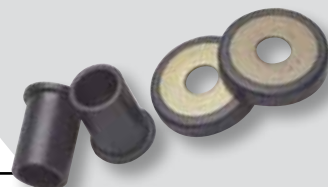

Kawasaki

Eng	Year	Model No	Lower A-Arm Kit	Upper A-Arm Kit	Rear Independent Suspension Kit	Swing Arm Bearing Kit	Front shock bushing kit	Rear shock bushing kit
300	1986 - 87	KLF300A Bayou		550.1010				
300	1988 - 04	KLF300B Bayou	550.1040	550.1040				
300	1989 - 04	KLF300C Bayou 4X4	550.1040	550.1040				
300	1999 - 02	KVF300A / B Prairie 4x4	550.1040			528.1059	521-0006	
360	2003 - 13	KVF360A / B / C Prairie 4x4	550.1040			528.1059	521-0006	521-0005
400	1993 - 99	KLF400 Bayou	550.1040	550.1040				
400	1997 - 02	KVF400A / B / C Prairie 4x4	550.1040			528.1059		
450	2008 - 14	KFX450R	550.1067	550.1029				
620	1994 - 13	KAF 620 Mule 2500/2510/2520/3010/4010	550.1040					
650	2005 - 13	KVF650 Brute force	550.1031			528.1059		
650	2006 - 13	KVF650 I Brute force	550.1029	550.1032	550.1043			
650	2002 - 03	KVF650 Prairie	550.1031			528.1059	521.0006	
700	2004 - 09	KFX 700 V-Force	550.1029	550.1029		528.1059	521.0006	521.0005
700	2004 - 06	KVF700 Prairie	550.1031			528.1059		
750	2005 - 11	KVF750 Brute Force	550.1029	550.1032	550.1043			
750	2012 - 14	KVF750 Brute Force	550.1089	550.1088	550.1043			
950	2000 - 13	KAF950 Mule Diesel 2510/3010/4010	550.1040					

Polaris

Eng	Year	Model No	Lower A-Arm Kit	Upper A-Arm Kit	Rear Independent Suspension Kit	Swing Arm Bearing Kit	Front shock bushing kit	Rear shock bushing kit
200	2005 - 13	Phoenix 200				528.1056		
200	2007	Sawtooth 200				528.1056		
250	1990 - 06	Trail Blazer 250	550.1048					
250	1988 - 92	Trail Boss 250	550.1049					
250	1993 - 99	Trail Boss 250	550.1048					
250	1987 - 92	Trail Boss 250 4x4	550.1049					
250	1993	Trail Boss 250 4x4	550.1048					
250	2000 - 02	Xplorer 250 4X4	550.1048					
300	1994 - 95	300 2x4 / 4x4	550.1048					
300	2006 - 11	Hawkeye 2x4 / 4x4	550.1049		550.1057			
300	2008 - 10	Sportsman 300 4X4	550.1049		550.1057			
300	1995	Trail Boss 300 4X4	550.1048					
300	1996 - 99	Xplorer 300 4x4	550.1048					
300	1996 - 99	Xpress 300	550.1048					
325	2000 - 02	Magnum 325 2x4/4x4/HDS	550.1048					
325	2000 - 02	Trail Boss 325	550.1048					
325	2000 - 02	Xpedition 325	550.1048					
330	2004 - 05	ATP 330 4X4	550.1049					
330	2003 - 05	Magnum 330 2x4 / 4x4	550.1049					
330	2008 - 13	Trail Blazer 330	550.1049					
330	2003 - 13	Trail Boss 330	550.1049					
335	1999 - 00	Sportsman 335	550.1048		550.1054			
335	1999	Worker 335	550.1048		550.1054			

SUSPENSION KITS

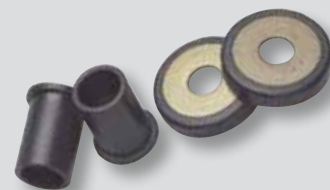

Polaris Cont.

Eng	Year	Model No	Lower A-Arm Kit	Upper A-Arm Kit	Rear Independent Suspension Kit	Swing Arm Bearing Kit	Front shock bushing kit	Rear shock bushing kit
380	2000	Scrambler 380 2x4	550.1048					
400	1995 - 02	Scrambler 400 2x4	550.1048					
400	1994 - 99	Sport 400	550.1048					
400	1994 - 97	Sportsman 400 4x4	550.1048					521.5000
400	2001 - 02	Sportsman 400 4x4	550.1048		550.1054			521.5000
400	2003 - 05	Sportsman 400 4x4	550.1049		550.1046			521.5000
400	2008 - 10	Sportsman 400 HO 4x4	550.1049		550.1057			521.5000
400	2011 - 14	Sportsman 400 HO 4x4	550.1049		550.1046			521.5000
400	2003	Trail Blazer 400	550.1049					
400	1995 - 02	Xplorer 400L 4x4	550.1048					
425	1995 - 98	Magnum 425 2x4	550.1048					
425	2000 - 02	Xpedition 425	550.1048					
450	2006 - 07	Sportsman 450	550.1049		550.1046			521.5000
455	1999 - 01	Diesel 455 4x4	550.1048					
500	2004 - 05	ATP 500 4X4	550.1049					
500	1999 - 03	Magnum 500 4x4	550.1048					
500	1997 - 02	Scrambler 500 2x4	550.1048					
500	2003	Scrambler 500 4x4	550.1049					
500	2004 - 07	Scrambler 500 4x4	550.1049					
500	2008 - 09	Scrambler 500 4x4	550.1049					
500	2010 - 12	Scrambler 500 4x4	550.1049					
500	1996 - 99	Sportsman 500 4x4	550.1048		550.1054			521.5000
500	2000	Sportsman 500 4x4	550.1048		550.1054			521.5000
500	2001	Sportsman 500 4x4 DUSE	550.1048		550.1054			521.5000
500	2002	Sportsman 500 4x4 DUSE	550.1048		550.1054			521.5000
500	2001 - 02	Sportsman 500 4x4 HO	550.1048		550.1046			521.5000
500	2003 - 13	Sportsman 500 4x4 HO	550.1049		550.1046			521.5000
500	2000 - 02	Sportsman 500 4x4 RSE	550.1048		550.1054			521.5000
500	2008 - 10	Sportsman 500 EFI / HO	550.1049		550.1046			521.5000
500	2006 - 07	Sportsman 500 X2	550.0050		550.1047			521.5000
500	2008 - 09	Sportsman 500 X2	550.0050		550.1056			521.5000
500	2011 - 13	Sportsman Forest 500	550.1049		550.1046			521.5000
500	2008	Sportsman Touring 500 EFI	550.1049		550.1046			521.5000
500	2009 - 13	Sportsman Touring 500 EFI	550.0050		550.1046			521.5000
500	1999 - 00	Worker 500 4x4	550.1048		550.1054			
500	1997	Xplorer 500	550.1048		550.1054			
550	2010	Sportsman 550 EPS / X2	550.0050	550.0050	550.1084		521.5000	521.5000
550	2011	Sportsman 550 / EPS / X2	550.1051	550.1051	550.1083		521.5000	521.5000
550	2012 - 13	Sportsman 550 / EPS / X2	550.1051	550.1051	550.1082		521.5000	521.5000

SUSPENSION KITS

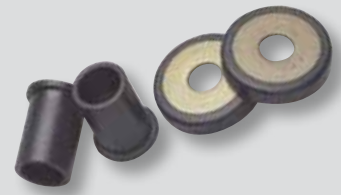

Polaris Cont.

Eng	Year	Model No	Lower A-Arm Kit	Upper A-Arm Kit	Rear Independent Suspension Kit	Swing Arm Bearing Kit	Front shock bushing kit	Rear shock bushing kit
550	2009	XP 550 Built	550.1051	550.1051			521.5000	521.5000
570	2014	Sportsman 570	550.1049		550.1046			
600	2003 - 05	Sportsman 600 4x4	550.1049		550.1046			521.5000
700	2002 - 07	Sportsman 700 4x4	550.1049		550.1046			521.5000
700	2005	Sportsman MV7	550.1049		550.1046			521.5000
700	2008	Sportsman X2 700 Twin EFI	550.0050		550.1056			521.5000
800	2005 - 13	Sportsman 800 EFI	550.1049		550.1046			521.5000
800	2008	Sportsman Touring 800 EFI	550.1049		550.1056			521.5000
800	2009	Sportsman Touring 800 EFI	550.0050		550.1056			521.5000
800	2007	Sportsman X2 800 EFI	550.0050		550.1047			521.5000
800	2008 - 09	Sportsman X2 800 EFI	550.0050		550.1056			521.5000
850	2012 - 13	Sportsman Forest 850 / EPS / Touring	550.1051	550.1051	550.1082		521.5000	521.5000
850	2010	Sportsman Touring EPS 850	550.0050	550.0050	550.1083		521.5000	521.5000
850	2011	Sportsman X2 850	550.1051	550.1051	550.1083		521.5000	521.5000
850	2009	Sportsman XP 850	550.1051	550.1051	550.1085		521.5000	521.5000
850	2010	Sportsman XP 850, Sportsman XP 850 EPS	550.0050	550.0050	550.1084		521.5000	521.5000
850	2011	Sportsman XP 850	550.1051	550.1051	550.1083		521.5000	521.5000
850	2012 - 14	Sportsman XP 850 EPS	550.1051	550.1051	550.1082		521.5000	521.5000
0	2011 - 12	LSV ELECTRIC 4X4	550.1074*		550.1072			
0	2010 - 13	RANGER EV 4X4	550.1074*		550.1072			
400	2010 - 14	Ranger 4x4 400	550.1074*		550.1072		521.5000	521.5000
500	2008 - 09	Ranger 2x4 500	550.1074*		550.1072			
500	2004 - 08	Ranger 4x4 500	550.1074*		550.1072			
500	2009 - 10	Ranger 4x4 500	550.1074*	550.1074*	550.1072		521.5000	521.5000
500	2011 - 13	Ranger 4x4 500 Et CREW	550.1074*		550.1072		521.5000	521.5000
500	2004	Ranger 6X6 500	550.1074*		550.1072			
500	2000 - 02	Sportsman 500 6x6	550.1048					
500	2003 - 08	Sportsman 500 6x6	550.1049					
570	2012 - 13	Ranger RZR 570	550.1049	550.1049	550.1081			
570	2014	Ranger RZR 570	550.1049	550.1049				
700	2005 - 08	Ranger 4x4 700	550.1074*		550.1072			
700	2009	Ranger 4x4 700	550.1074*	550.1074*	550.1072		521.5000	521.5000
700	2007 - 09	Ranger 4x4 700 Et CREW	550.1074*		550.1072			
700	2006 - 07	Ranger 6x6 700 EFI	550.1074*					
700	2008 - 09	Ranger 6x6 700 EFI	550.1074*		550.1072			
800	2010 - 14	Ranger 4x4 800 EFI Et CREW	550.1074*	550.1074*	550.1072		521.5000	521.5000
800	2010 - 14	RANGER 6X6 800	550.1074*	550.1074*	550.1072		521.5000	521.5000
800	2009 - 13	RANGER RZR S 800 / 4/ EPS RGE	550.1049	550.1049	550.1077			
800	2012	RANGER XP 800	550.1074*	550.1074	550.1072		521.5000	521.5000
800	2008 - 13	RZR 800	550.1049	550.1049	550.1077			
800	2009 - 12	Sportsman 800 EFI 6x6	550.1049					521.5000
850	2012 - 13	Sportsman Touring EPS 850	550.1051	550.1051	550.1082			
900	2011 - 14	Ranger 4x4 900 D	550.1074*	550.1074*	550.1072		521.5000	521.5000

*550.1074 Polaris Ranger Upgraded Kit available - Use 550.1074-1

SUSPENSION KITS

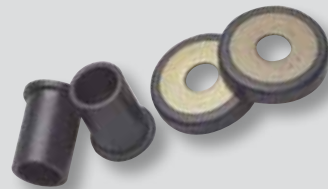

Polaris Cont.

Eng	Year	Model No	Lower A-Arm Kit	Upper A-Arm Kit	Rear Independent Suspension Kit	Swing Arm Bearing Kit	Front shock bushing kit	Rear shock bushing kit
900	2012 - 13	Ranger 4x4 CREW DIESEL 900 D	550.1074*	550.1074*	550.1072		521.5000	521.5000
900	2011 - 13	Ranger RZR XP 900	550.1076	550.1049				

*550.1074 Polaris Ranger Upgraded Kit available - Use 550.1074-1

Suzuki

Eng	Year	Model No	Lower A-Arm Kit	Upper A-Arm Kit	Rear Independent Suspension Kit	Swing Arm Bearing Kit	Front shock bushing kit	Rear shock bushing kit
250	1987 - 98	LT-4WD 250	550.1039	550.1039				
250	1988 - 01	LT-F250	550.1039	550.1039				
250	2002 - 12	LT-F250 Ozark	550.1039	550.1039				
250	1999 - 02	LT-F250F (Except Ozark)		550.1039				
250	1997 - 98	LT-F4WD 250	550.1039	550.1039				
250	2004 - 09	LT-Z250	550.1039	550.1039		528.1133		
300	1991 - 02	LT-F4WDX King Quad 300	550.1039	550.1039				
400	2008 - 13	LT-A / LT-F400 2x4 / 4x4 King Quad	550.1039	550.1039				
400	2002 - 07	LT-A / LT-F400 Eiger 2wd / 4wd	550.1039	550.1039				
450	2007	LTA-450 X King Quad	550.1039	550.1037	550.1041			
450	2008 - 10	LTA-450 X King Quad	550.1039	550.1037	550.1045			
500	2000 - 01	LT-A500F Quad Master Auto	550.1039	550.1039				
500	2002 - 07	LT-A500F Vinson	550.1039	550.1039		528.1155		
500	2009 - 13	LT-A500X / XP	550.1039	550.1078	550.1075			
500	2000 - 01	LT-F500F Quad Master	550.1039	550.1039				
500	1998 - 99	LT-F500F Quad Runner	550.1039	550.1039				
500	2002	LT-F500F Vinson	550.1039	550.1039				
500	2003 - 07	LT-F500F Vinson	550.1039	550.1039		528.1155		
700	2005 - 07	LTA-700 X King Quad	550.1039	550.1037	550.1041			
700	2004 - 06	LTV-700F Twin Peaks	550.1031			528.1059		
750	2008 - 13	LTA-750 X / XP King Quad	550.1039	550.1078	550.1075			

Yamaha

Eng	Year	Model No	Lower A-Arm Kit	Upper A-Arm Kit	Rear Independent Suspension Kit	Swing Arm Bearing Kit	Front shock bushing kit	Rear shock bushing kit
125	1991 - 03	YFA1	550.1009			528.1130		
125	2004	YFA1	550.1009			528.1130		
125	2004	YFM125 Grizzly	550.1009			528.1130		

SUSPENSION KITS

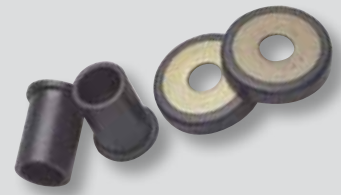

Yamaha Cont.

Eng	Year	Model No	Lower A-Arm Kit	Upper A-Arm Kit	Rear Independent Suspension Kit	Swing Arm Bearing Kit	Front shock bushing kit	Rear shock bushing kit
125	2005 - 13	YFM125 Grizzly	550.1009			528.1130		
125	2011 - 13	YFM125 Raptor	550.1009	550.1005		528.1187		
200	1986 - 89	YFM200 Moto-4	550.1011			528.1058		
225	1986 - 88	YFM225 Moto-4	550.1001			528.1058		
225	1983 - 86	YFM225 Tri-Moto				528.1058		
250	1992 - 98	YFB250 Timberwolf	550.1036			528.1058		
250	1994 - 00	YFB250FW Timberwolf	550.1036			528.1058		
250	1999 - 04	YFM250 Beartracker	550.1036			528.1084		
250	2007 - 09	YFM250 Big Bear	550.1036			528.1084		
250	1989 - 91	YFM250 Moto-4	550.1001			528.1058		
250	2005 - 06	YFM250B Bruin	550.1036			528.1084		
250	2008 - 13	YFM250 RAPTOR	550.1009	550.1005		528.1187		
350	2007 - 11	YFM350 Grizzly IRS	550.1036	550.1036	550.1034*			
350	2013	YFM350 Grizzly	550.1036	550.1036				
350	2004 - 06	YFM350A Bruin 2WD	550.1036	550.1036				
350	1987 - 95	YFM350ER Moto-4		550.1001		528.1058		
350	2004 - 06	YFM350FA Bruin 4WD	550.1036	550.1036				
350	2007 - 14	YFM350FGW Grizzly 4WD	550.1036	550.1036				
350	1987 - 99	YFM350FW Big Bear	550.1036	550.1036		528.1058		
350	2007 - 11	YFM350GW Grizzly 2WD	550.1036	550.1036				
350	1996 - 99	YFM350U Big Bear	550.1036	550.1036		528.1058		
350	1995 - 05	YFM35FX Wolverine	550.1036	550.1036		528.1058		
350	2006 - 09	YFM35X Wolverine	550.1036	550.1036				
350	2009 - 13	YFM350 RAPTOR	550.1009	550.1009		528.1124		
400	2000 - 06	YFM400 Big Bear 2WD/4WD	550.1036	550.1036		528.1084		
400	2007 - 12	YFM400 Big Bear IRS	550.1036	550.1036	550.1034*			
400	2007 - 08	YFM400 Grizzly IRS	550.1036	550.1036	550.1034*			
400	2000 - 04	YFM400 Kodiak 2WD	550.1036	550.1036				
400	1999	YFM400 Kodiak 4WD	550.1036	550.1036		528.1058		
400	2000 - 06	YFM400 Kodiak 4WD	550.1036	550.1036				
450	2007 - 14	YFM450 Grizzly IRS	550.1036	550.1036	550.1034*			
450	2003 - 04	YFM450 Kodiak	550.1036	550.1036				
450	2005 - 06	YFM450 Kodiak	550.1036	550.1036	550.1034*			
450	2006 - 10	YFM45FX Wolverine 450 4X4	550.1036	550.1036				
450	2009 - 14	YFZ450R/X	550.1009	550.1058				
550	2009 - 14	YFM550 Grizzly / EPS	550.1036	550.1036	550.1034*			
600	1998 - 01	YFM600 Grizzly	550.1036			528.1058		
660	2002 - 08	YFM660 Grizzly	550.1036	550.1036	550.1034*			
700	2007 - 14	YFM700 Grizzly	550.1036	550.1036	550.1034*			
700	2008 - 14	YFM700 Grizzly EPS	550.1036	550.1036	550.1034*			
450	2006 - 09	450RHINO	550.1036	550.1036	550.1034*			
660	2004 - 07	660 RHINO	550.1036	550.1036	550.1034*			
700	2008 - 13	700 RHINO FI	550.1036	550.1036	550.1034*			

*550.1034 - Knuckle only kit available - 550.1034-1

BALL JOINTS



Arctic Cat

Lower Ball Joint Kit ATV City Part No.	Upper Ball Joint Kit ATV City Part No.	Model
	542.1032	250 2x4 1999 - 05
542.1032	542.1032	250 4x4 2001 - 05
542.1032	542.1032	300 2x4 1998 - 04
542.1032	542.1032	300 4x4 1998 - 05
542.1032	542.1032	350 Utility 4x4 2011
542.1032	542.1032	350 CR 2012
542.1032	542.1032	366 FIS w/AT 2008 - 11
542.1032	542.1032	375 2x4 - 4x4 w/AT 2002
542.1032	542.1032	400 2x4 1998 - 01
542.1032	542.1032	400 4x4 1998 - 00
542.1032	542.1032	400 4x4 w/AT 2003 - 04
542.1032	542.1032	400 4x4 w/MT 2001-04
542.1032	542.1032	400 FIS 2x4 w/AT - w/MT 2003 - 04
542.1032	542.1032	400 FIS 4x4 TRV 2009 - 13
542.1032	542.1032	400 FIS 4x4 w/AT 2003 - 08
542.1032	542.1032	400 FIS 4x4 w/MT 2002-08
542.1032	542.1032	400 TBX 4x4 2004 - 06
542.1032	542.1032	400 TRV 2007
542.1032	542.1032	400 VP 4x4 2006
542.1032	542.1032	425 4x4 2011 - 12
542.1032	542.1032	450 H1 2010 - 11
542.1032	542.1032	450i EFI, TRV, GT 2012
542.1032	542.1032	450XC 4x4 2011-12
542.1032	542.1032	550 TRV XT 2013
542.1032	542.1032	454 2x4 / 4x4 1997 - 98
542.1032	542.1032	500 4x4 1998 - 99
542.1032	542.1032	500 4x4 w/AT 2000 - 02
542.1032	542.1032	500 4x4 w/MT 2000 - 01
542.1032	542.1032	500 EFI 2013
542.1032	542.1032	500 FIS 4x4 w/AT 2002-09
542.1032	542.1032	500 FIS 4x4 w/MT 2002-09
542.1032	542.1032	500 FIS TBX 4x4 2002 - 06
542.1032	542.1032	500 FIS TRV 4x4 2003 - 08
542.1032	542.1032	500 TRV 2013
542.1032	542.1032	500 XT EFI, EFI 4x4 2013
542.1032	542.1032	550 GT EFI 4X4 2012

BALL JOINTS



Arctic Cat Cont.

Lower Ball Joint Kit ATV City Part No.	Upper Ball Joint Kit ATV City Part No.	Model
542.1032	542.1032	550 H1 FIS 4X4 2009 - 11 2009 - 11
542.1032	542.1032	550 i EFI 4X4 2012 2012
542.1032	542.1032	550 TRV 4X4 2013
542.1032	542.1032	550 TRV 4x4 w/AT 2009 - 11
542.1032	542.1032	550 XT EFI 4X4 2013
542.1032	542.1032	550i TRV GT EFI 4X4 2012
542.1032	542.1032	650 4x4 H1 2005 - 09
542.1032	542.1032	650 4x4 H1, 650 4x4 H1 Mud Pro 2010 - 11
542.1032	542.1032	650 4x4 w/AT V2 2004 - 06
542.1032	542.1032	650i 4x4 2012
542.1032	542.1032	700 EFI 4x4 2006 -13
542.1032	542.1032	700 EFI H1 MUDPRO 2009 - 11
542.1032	542.1032	700 GT EFI 2012
542.1032	542.1032	700 H1 TRV 2008-11
542.1032	542.1032	700 LTD EFI 2013
542.1032	542.1032	700 XT 2013
542.1032	542.1032	700i Diesel EFI 2008-13
542.1032	542.1032	700i EFI MUDPRO 2012-13
542.1032	542.1032	700i TRV Cruiser / GT EFI 2012
542.1032	542.1032	1000 Cruiser / Gti 2012
542.1032	542.1032	1000 TRV GT 2012
542.1032	542.1032	1000 TRV LTD 2013
542.1032	542.1032	1000 XT 2013
542.1032	542.1032	1000i LDT EFI MUDPRO 2012-13
542.1032	542.1032	H2 MUDPRO 2010 - 11
542.1032	542.1032	H2 THUNDERCAT 2008 - 11

Arctic Cat - Sport ATV

Lower Ball Joint Kit ATV City Part No.	Upper Ball Joint Kit ATV City Part No.	Model
	542.1019	400 DVX 2004 - 08



BALL JOINTS



Arctic Cat - UTV

Lower Ball Joint Kit ATV City Part No.	Upper Ball Joint Kit ATV City Part No.	Model
542.1032	542.1032	550 Prowler XT 2009 - 13
542.1032	542.1032	650 Prowler XT 2006 - 09
542.1032	542.1032	700 Prowler HDX 2012 - 13
542.1032	542.1032	700 Prowler XT 2008 - 13
542.1032	542.1032	1000 Prowler XTZ 2011-13
542.1032	542.1032	Prowler H2 1000 XTZ 2009 - 11
542.1032	542.1032	Wildcat GT 2012 - 13

Can Am - Utility ATV

Lower Ball Joint Kit ATV City Part No.	Upper Ball Joint Kit ATV City Part No.	Model
542.1040	542.1036	Outlander 400 2006 - 14
542.1040	542.1036	Outlander 500 2007 - 12
542.1042	542.1043	Outlander 500 2013 - 14
542.1040	542.1036	Outlander 500 Power Steering 2010 - 12
542.1039	542.1039	Quest 500 2002 - 03
542.1039	542.1039	Renegade 500 2008 - 12
542.1042	542.1043	Renegade 500 2013 - 14
542.1039	542.1039	Renegade 500 Power Steering 2012
542.1039	542.1039	Traxter 500 1999 - 05
542.1040	542.1039	Outlander 650 2007 - 12
542.1042	542.1043	Outlander 650 2013 - 14
542.1040	542.1039	Outlander 650 Power Steering 2010 - 12
542.1039	542.1039	Quest 650 2002 - 04
542.1039	542.1039	Traxter 650 2004-05
542.1040	542.1039	Outlander 800 2006 - 11
542.1042	542.1043	Outlander 800 2013 - 14
542.1040	542.1039	Outlander 800 Power Steering 2010 - 11
542.1040	542.1039	Outlander 800 Power Steering-MAX 2012
542.1040	542.1039	Outlander 800 Xmr-MAX 2012
542.1042	542.1043	Outlander STD XT 800R 2012
542.1039	542.1039	Renegade 800 2007 - 11
542.1042	542.1043	Renegade 800 2012 - 13
542.1039	542.1039	Renegade 800 Power Steering 2010 - 11
542.1042	542.1043	Outlander 1000 2013 - 14
542.1042	542.1043	Outlander STD XT 1000 2012 - 14
542.1042	542.1043	Renegade 1000 2012 - 14

BALL JOINTS



Can Am - Sport ATV

Lower Ball Joint Kit ATV City Part No.	Upper Ball Joint Kit ATV City Part No.	Model
542.1050	542.1050	DS650 2000 - 07

Can Am - UTV

Lower Ball Joint Kit ATV City Part No.	Upper Ball Joint Kit ATV City Part No.	Model
542.1042	542.1043	Commander 800 2011 - 13
542.1042	542.1043	Commander 1000 2011 - 13
542.1042	542.1043	Maverick 1000 2013

Honda - Utility ATV

Lower Ball Joint Kit ATV City Part No.	Upper Ball Joint Kit ATV City Part No.	Model
542.1008	542.1009	TRX250 Recon 1997 - 14
542.1014	542.1009	TRX250EX Sportrax 2001 - 14
	542.1033	TRX300 Fourtrax 300 1988 - 92
542.1009	542.1009	TRX300 Fourtrax 300 1993 - 00
542.1009	542.1009	TRX300FW Fourtrax 4x4 1988 - 00
542.1009	542.1015	TRX350FE/FM/TE/TM 2000 - 06
542.1009	542.1015	TRX400FA/FGA 2004 - 07
542.1009	542.1009	TRX400FW Fourtrax Foreman 4X4 1995 - 03
542.1009	542.1015	TRX420 FA / FPA 2009 - 14
542.1009	542.1015	TRX420 FE/FM/TE/TM/FPE/FPM 2007 - 13
542.1015	542.1015	TRX420 FE/FM/TE/TM 2014
542.1015	542.1015	TRX450FE/FM/ES/S 1998 - 04
542.1015	542.1015	TRX500FA 2001 - 14
542.1015	542.1015	TRX500FE/TM/FPA/FM 2005 - 14
542.1015	542.1015	TRX650 Rincon 2003 - 05
542.1015	542.1015	TRX680 Rincon 2006 - 14



BALL JOINTS



Kawasaki - Utility ATV

Lower Ball Joint Kit ATV City Part No.	Upper Ball Joint Kit ATV City Part No.	Model
542.1018	542.1018	KLF300B/A Bayou 1986 - 04
542.1016	542.1017	KLF300C Bayou 4X4 1989 - 04
542.1016	542.1036	KVF300A/B Prairie 4x4 / 2x4 1999 - 00
542.1020	542.1036	KVF300A/B Prairie 4x4 / 2x4 2001 - 02
542.1033	542.1036	KVF360A Et C Prairie 4x4 2003 - 13
542.1033	542.1036	KVF360B Prairie 2003 - 10
542.1016	542.1017	KLF400 Bayou 1993 - 99
542.1016	542.1036	KVF400A / B Prairie 1997 - 98
542.1016	542.1036	KVF400C Prairie 4x4 1999 - 00
542.1020	542.1036	KVF400C Prairie 4x4 2001 - 02
542.1016	542.1036	KVF400D Prairie 1999 - 00
542.1020	542.1036	KVF400D Prairie 2001 - 02
542.1033	542.1036	KVF650 Brute force 2005 - 13
542.1033	542.1033	KVF650 I Brute force 2006 - 13
542.1033	542.1036	KVF650 Prairie 2002 - 03
542.1033	542.1033	KFX 700 V-Force 2004 - 09
542.1033	542.1036	KVF700 Prairie 2004 - 06
542.1033	542.1033	KVF750 Brute Force / EPS 2005 - 14

Kawasaki - Sport ATV

Lower Ball Joint Kit ATV City Part No.	Upper Ball Joint Kit ATV City Part No.	Model
542.1016	542.1017	KSF250 Mojave 1987 - 04
542.1016	542.1017	KEF300 Lakota 1995 - 03
	542.1027	KFX400 2003
	542.1019	KFX400 2004 - 06
542.1033	542.1033	KFX450R 2008 - 14

Kawasaki - UTV

Lower Ball Joint Kit ATV City Part No.	Upper Ball Joint Kit ATV City Part No.	Model
542.1041		Mule 600 / 610 2005 - 14
542.1041		Mule 2500 1994 - 00
542.1041		Mule 2520 1993 - 00
542.1041		Mule 3000 /3010 2001 - 08
542.1041		Mule 3020 2001 - 03

BALL JOINTS



Kawasaki - UTV Cont.

Lower Ball Joint Kit ATV City Part No.	Upper Ball Joint Kit ATV City Part No.	Model
542.1041		Mule 4000 2009 - 13
542.1041		Mule 4010 4x4 2009 - 14
542.1033	542.1033	TERYX 4 4X4 2012 - 14
542.1033	542.1033	TERYX 750 4X4 2008 - 13
542.1033		Mule 2510 Diesel 2000 - 02
542.1033		Mule 3010 Diesel 2003 - 06
542.1041		Mule 4010 4x4 Diesel 2010
542.1033		Mule 4010 4x4 Diesel 2011 - 13

Polaris - Utility ATV

Lower Ball Joint Kit ATV City Part No.	Upper Ball Joint Kit ATV City Part No.	Model
542.1031	542.1031	Phoenix 200 2005 - 14
542.1031	542.1031	Sawtooth 200 2006 - 07
542.1030		Trail Blazer 250 1990 - 06
542.1030		Trail Boss 250 1988 - 99
542.1030		Trail Boss 250 4x4 1989 - 93
542.1030		Xplorer 250 4X4 2000 - 02
542.1030		300 2x4 / 4x4 1994 - 95
542.1037		Hawkeye 2x4 2006 - 11
542.1037		Hawkeye 4x4 2006 - 07
542.1037		Sportsman 300 4X4 2008 - 10
542.1030		Trail Boss 300 4X4 1995
542.1030		Xplorer 300 4x4 1996 - 99
542.1030		Xpress 300 1996 - 99
542.1030		Magnum 325 2x4 / 4x4 2000 - 02
542.1030		Magnum 325 4x4 HDS 2001 - 02
542.1030		Trail Boss 325 2000 - 02
542.1030		Xpedition 325 2000 - 02
542.1030		ATP 330 4X4 2004 - 05
542.1030		Magnum 330 2x4 / 4x4 2003 - 05
542.1030		Trail Blazer 330 2008-13
542.1030		Trail Boss 330 2003 - 13
542.1030		Sportsman 335 1999-00
542.1030		Worker 335 1999
542.1030		350L 2x4 / 4x4 1993
542.1030		Sportsman 350 4x4 1993
542.1030		Trail Boss 350L 2x4 / 4x4 1990 - 92

BALL JOINTS



Polaris - Utility ATV Cont.

Lower Ball Joint Kit ATV City Part No.	Upper Ball Joint Kit ATV City Part No.	Model
542.1030		Scrambler 380 2x4 2000
542.1030		400L 1994-95
542.1030		Hawkeye 400 HO 2x4 2012 - 14
542.1030		Scrambler 400 2x4 1995 - 02
542.1030		Sportsman 400 4x4 1994 - 97
542.1030		Sportsman 400 4x4 2001-05
542.1030		Sportsman 400 4x4 AA AE AG 2004
542.1037		Sportsman 400 HO 4x4 2009 - 10
542.1030		Sportsman 400 HO 4x4 2011 - 14
542.1037		Sportsman 400 HO 4x4 2008
542.1030		Trail Blazer 400 2003
542.1030		Xplorer 400L 4x4 1995 - 02
542.1030		Magnum 425 2x4 / 4x4 1995 - 98
542.1030		Xpedition 425 2000 - 02
542.1030		Sportsman 450 2006 - 07
542.1030		Diesel 455 4x4 1999 - 01
542.1030		ATP 500 4X4 2004 - 05
542.1030		ATV 500 Pro 2002
542.1030		Magnum 500 2x4 HDS 2002
542.1030		Magnum 500 4x4 1999 - 02
542.1030		Magnum 500 4x4 HDS 2001 - 03
542.1030		PTV Series 10 4x4 2003
542.1030		Scrambler 500 4x4 1998 - 12
542.1030		Sportsman 500 4x4 / X2 1996 - 13
542.1030		Sportsman Touring 500 EFI 2008 - 13
542.1030		Worker 500 4x4 1999 - 02
542.1030		Xplorer 500 1997
542.1037	542.1037	Sportsman 550 2010 - 14
542.1037	542.1037	XP 550 2009
542.1030		Sportsman 570 2014
542.1030		Sportsman 600 4x4 2003 - 05
542.1030		Sportsman 700 4x4 2002 - 08
542.1030		Sportsman 800 2005 - 13
542.1037	542.1037	Scrambler HO/ EPS 850 2013
542.1037	542.1037	Sportsman 850 2010 - 14
542.1037	542.1037	Sportsman XP 850 2009 - 14
542.1037		Scrambler HO/EPS 850 2014
542.1037		Scrambler XP 850 HO EPS 2014

BALL JOINTS



Polaris - Sport

Lower Ball Joint Kit ATV City Part No.	Upper Ball Joint Kit ATV City Part No.	Model
542.1035	542.1035	Outlaw 450 2008 - 10
542.1035	542.1035	Outlaw 500 2006 - 07
542.1031	542.1031	Predator 500 2003 - 06
542.1035	542.1035	Predator 500 2007
542.1035	542.1035	Outlaw 525 IRS / S 2007 - 11

Polaris - UTV

Lower Ball Joint Kit ATV City Part No.	Upper Ball Joint Kit ATV City Part No.	Model
542.1030		LSV ELECTRIC 4X4 2011 - 12
542.1030		RANGER EV 4X4 2010 - 13
542.1030		Big Boss 250 4x6 / 6x6 1989 - 93
542.1030		Big Boss 300 6x6 1994
542.1030		Big Boss 350L 6x6 1993
542.1030		Big Boss 400L 6x6 1994 - 97
542.1030		Magnum 400L 6x6 1996 - 97
542.1030		Ranger 4x4 400 2010 - 14
542.1030		Big Boss 500 6x6 1998 - 03
542.1030		PTV Series 10 6X6 2003
542.1030		Ranger 2x4 500 2008 - 09
542.1030		Ranger 4x4 500 1999 - 08
542.1037	542.1037	Ranger 4x4 500 2009 - 10
542.1030		Ranger 4x4 500 2011 - 13
542.1030		Ranger 4x4 500 Crew 2011 - 13
542.1030		Ranger 6X6 500 2002 - 04
542.1030		Ranger Series 10 / 11 4x4 & 6x6 2007
542.1030		Sportsman 500 6x6 2000 - 08
542.1037	542.1037	RANGER RZR 570 EFI 2012 - 14
542.1030		Ranger 4x4 700 2005 - 08
542.1037	542.1037	Ranger 4x4 700 2009
542.1030		Ranger 4x4 700 CREW 2008 - 09
542.1030		Ranger 6x6 700 EFI 2006 - 09
542.1037	542.1037	Ranger 4x4 800 EFI / CREW 2010 - 14
542.1030		Ranger 4x4 800 EFI MIDSIZE 2013 - 14
542.1037	542.1037	RANGER 6X6 800 2010 - 14
542.1037	542.1037	RANGER 800 Crew 2013 - 14
542.1037	542.1037	RANGER RZR 4/EPS RGE 2010 -14

BALL JOINTS



Polaris - UTV Cont.

Lower Ball Joint Kit ATV City Part No.	Upper Ball Joint Kit ATV City Part No.	Model
542.1037	542.1037	RANGER RZR 4 800 2010 - 13
542.1037	542.1037	RANGER RZR S 800 2009 - 14
542.1037	542.1037	RANGER XP 800 2012
542.1037	542.1037	RZR 800 XP 2008 - 13
542.1037	542.1037	RZR 800 2008 - 13
542.1037	542.1037	Ranger 4x4 CREW DIESEL 900 2011 - 14
542.1037	542.1037	Ranger 4x4 DIESEL 900 2011 - 14
542.1037	542.1037	Ranger 900 XP 2013 - 14
542.1037	542.1037	Ranger RZR XP 900 2011 - 14
542.1051	542.1051	RZR XP 1000 2014

Suzuki - Utility ATV

Lower Ball Joint Kit ATV City Part No.	Upper Ball Joint Kit ATV City Part No.	Model
542.1022	542.1024	LT-250EF 1985 - 86
542.1022	542.1022	LT-4WD 250 1987 - 98
542.1022	542.1022	LT-F250 1988 - 01
	542.1027	LT-F250 Ozark 2002 - 04
	542.1019	LT-F250 Ozark 2005 - 13
542.1022	542.1022	LT-F250F (Except Ozark) 1999 - 02
542.1022	542.1022	LT-F4WD 250 1997 - 98
542.1022	542.1024	LT-300E 1987 - 89
542.1022	542.1022	LT-F300F King Quad 1991 - 02
542.1026	542.1026	LT-A / LT-F400 King Quad 2008 - 13
542.1026	542.1026	LT-A / LT-F400 Eiger 2002 - 07
542.1019	542.1019	LTA-450 X King Quad 2007 - 10
542.1022		LT-A500F Quad Master Auto 2000 - 01
542.1026	542.1026	LT-A500F Vinson 2002 - 07
542.1019	542.1019	LT-A500X 2009 - 13
542.1022		LT-F500F 1998 - 02
542.1026	542.1026	LT-F500F Vinson 2003 - 07
542.1019	542.1019	LTA-700 X King Quad 2005 - 07
542.1033	542.1036	LTV-700F Twin Peaks 2004 - 06
542.1019	542.1019	LTA-750 X King Quad 2008 - 13

BALL JOINTS



Suzuki - Sport ATV

Lower Ball Joint Kit ATV City Part No.	Upper Ball Joint Kit ATV City Part No.	Model
542.1029	542.1029	LT-Z250 2004 - 09
	542.1027	LT-Z400 2003 - 04
	542.1019	LT-Z400 2005 - 13
542.1022	542.1024	LT-500R 1987 - 90

Yamaha - Utility ATV

Lower Ball Joint Kit ATV City Part No.	Upper Ball Joint Kit ATV City Part No.	Model
	542.1036	YFB250 Timberwolf 1992 - 98
	542.1036	YFB250FW Timberwolf 1994 - 00
542.1028	542.1036	YFM250 Beartracker 1999 - 04
542.1028	542.1036	YFM250 Big Bear 2007 - 09
542.1028	542.1036	YFM250B Bruin 2005 - 06
542.1009	542.1009	YFM350 Grizzly 4WD 2013
542.1009	542.1009	YFM350 Grizzly IRS 2007 - 11
542.1009	542.1009	YFM350A / FA Bruin 2004-06
542.1009	542.1009	YFM350FGW Grizzly 4WD 2007 - 14
542.1009	542.1009	YFM350GW Grizzly 2WD 2007-11
542.1009	542.1009	YFM35X Wolverine 2006 - 09
542.1009	542.1009	YFM400 Big Bear 2WD 2000 - 04
542.1009	542.1009	YFM400 Big Bear 4WD 2000 - 06
542.1009	542.1009	YFM400 Big Bear IRS 2007 - 12
542.1009	542.1009	YFM400 Grizzly IRS 2007 - 08
542.1009	542.1009	YFM400 Kodiak 2WD 2003 - 04
542.1009	542.1009	YFM400 Kodiak 4WD 2003 - 06
542.1009	542.1009	YFM450 Grizzly EPS 2011 - 14
542.1009	542.1009	YFM450 Grizzly IRS 2007 - 14
542.1009	542.1009	YFM450 Kodiak 2003 - 06
542.1009	542.1009	YFM45FX Wolverine 450 4X4 2006 - 10
542.1038	542.1029	YFM550 Grizzly 2009 - 12
542.1038	542.1038	YFM550 Grizzly / EPS 2013 - 14
542.1038	542.1029	YFM550 Grizzly EPS 2009 - 12
	542.1036	YFM600 Grizzly 1998 - 01
542.1034		YFM600 Grizzly 2002
542.1034		YFM660 Grizzly 2002 - 08
542.1038	542.1029	YFM700 Grizzly 2007 - 12
542.1038	542.1038	YFM700 Grizzly / EPS 2013 - 14
542.1038	542.1029	YFM700 Grizzly EPS 2008 - 12

Bearings

Braking

Bullbars

Cables

Carburettor

Driveline

Electrical

Exhausts

BALL JOINTS



Yamaha - Sport

Lower Ball Joint Kit ATV City Part No.	Upper Ball Joint Kit ATV City Part No.	Model
542.1029		YFZ450 2004 - 13
542.1029	542.1029	YFZ450R 2009 - 14
542.1029	542.1029	YFZ450X 2010 - 11
542.1029		YFM660R Raptor 2001 - 05
542.1029		YFM700R Raptor 2006 - 13

Yamaha - UTV

Lower Ball Joint Kit ATV City Part No.	Upper Ball Joint Kit ATV City Part No.	Model
542.1009	542.1009	450RHINO 2006 - 09
542.1009	542.1009	660 RHINO 2004 - 07
542.1009	542.1009	700 RHINO FI 2008 - 13

STEERING BEARING KITS



Arctic Cat - Utility ATV

Model	Year	
250 2x4 / 4x4	1999 - 05	525.1614
300 4x4	1998 - 05	525.1614
350 Utility 4x4	2011	525.1614
350 CR	2012	525.1614
366 FIS w/AT	2008 - 11	525.1614
375 w/AT	2002	525.1614
400 4x4 / 2x4 w/AT - w/MT / FIS	1998 - 12	525.1614
400 TBX / TRV / VP 4x4	2004 - 06	525.1614
425 4x4	2011 - 12	525.1614
450i EFI, TRV, GT , H1	2010 - 12	525.1614
454	1996 - 98	525.1614
500 4x4 / FIS /TRV / XT	1998 - 13	525.1614
550 H1 FIS 4X4 / GT / TRV / XT	2009 - 13	525.1614
650 4x4 H1 / V2 / EFI	2004 - 11	525.1614
700 Diesel / EFI / HI / GT / LTD / XT /TRV	2008-13	525.1614
1000 Cruiser / TRV / XT / GT / H2	2008 - 12	525.1614

Can Am - Utility ATV

Model	Year	
Outlander 330	2004 - 05	525.1631
Outlander 400	2003 - 13	525.1631
Outlander 500	2007 - 12	525.1631
Quest 500	2002 - 03	525.1631
Renegade 500	2008 - 12	525.1631
Traxter 500	1999 - 05	525.1631
Outlander 650	2007 - 12	525.1631
Quest 650	2002 - 04	525.1631
Traxter 650	2004-05	525.1631
Outlander 800	2006 - 11	525.1631
Outlander 800 Xmr-MAX	2012	525.1631
Renegade 800	2007 - 11	525.1631

Can Am - Sport ATV

Model	Year	
DS 450 STD/X / MXC / XXC	2009 - 12	525.1631
DS650	2000 - 07	525.1631

STEERING BEARING KITS



CF-Moto - Utility ATV

Model	Year	
ATV 500		525.1515
X-LANDER		525.1515

Honda - Utility ATV

Model	Year	
TRX200/D	1990 - 97	525.1460
TRX250 Recon	1997 - 13	525.1460
TRX250EX Sportrax	2001 - 12	525.1460
TRX300 Fourtrax 300	1988 - 92	525.1460
TRX300 Fourtrax 300	1993 - 00	525.1459
TRX300FW Fourtrax 4x4	1988 - 00	525.1459
TRX350D	1986 - 89	525.1514
TRX350FE/FM/TE/TM	2000 - 06	525.1459
TRX400FA/FGA	2004 - 07	525.1459
TRX400FW Fourtrax Foreman 4X4	1995 - 03	525.1459
TRX420 FA/FM/FE/TE/TM/FP	2007 - 13	525.1459
TRX420 FE/FM/TE/TM	2014	525.1687
TRX450FE/FM/S/ES	1998 - 04	525.1459
TRX500FA	2001 - 14	525.1462
TRX500FE/FM/FP/TM	2005 - 11	525.1462
TRX500 FE/FM	2012-13	525.1685
TRX500 FE/FM	2014	525.1687
TRX650 Rincon	2003 - 05	525.1462
TRX680 Rincon	2006 - 14	525.1462

Honda - Sport ATV

Model	Year	
TRX250R	1988 - 89	525.1460
TRX250X	1987 - 92	525.1461
TRX300 EX	1993 - 09	525.1461
TRX400EX	1999 - 13	525.1460
TRX450ER	2006-13	525.1460
TRX450R	2004 - 09	525.1460
TRX700XX	2008 - 09	525.1460

STEERING BEARING KITS



Kawasaki - Utility ATV

Model	Year	
KLF220 Bayou	1988 - 11	522.1051
KLF250 Bayou	2003 - 11	522.1051
KLF300A / B / C Bayou	1986 - 04	522.1051
KLF400 Bayou	1993 - 99	522.1051
KVF400A / B / C Prairie 4x4	1997 - 99	522.1051
KFX 700 V-Force	2004 - 09	522.1051
KVF750 Brute Force	2012 - 14	525.1664

Kawasaki - Sport ATV

Model	Year	
KSF250 Mojave	1987 - 04	522.1051
KEF300 Lakota	1995 - 03	522.1051

Polaris - Utility ATV

Model	Year	
Trail Blazer 250	2002 - 06	525.1623
Xplorer 250 4X4	2001 - 02	525.1623
Hawkeye 2x4 / 4x4	2006 - 07	525.1623
Magnum 325	2002	525.1623
Trail Boss 325	2002	525.1623
Xpedition 325	2002	525.1623
ATP 330 4X4	2004 - 05	525.1623
Magnum 330 2x4 / 4x4	2003 - 05	525.1623
Trail Boss 330	2003 - 07	525.1623
Scrambler 400 2x4 / 4x4	2001 - 02	525.1623
Sportsman 400 4x4	2001-04	525.1623
Trail Blazer 400	2003	525.1623
Xplorer 400L 4x4	2001 - 02	525.1623
Xpedition 425	2001 - 02	525.1623
Sportsman 450	2006 - 07	525.1623
ATP 500 4X4	2004 - 05	525.1623
Magnum 500 4x4 HDS	2001 - 03	525.1623
Scrambler 500 4x4 / 2x4	2001 - 07	525.1623
Sportsman 500 4x4	2001 - 07	525.1623
Worker 500 4x4	2001 - 02	525.1623
Sportsman 600 4x4	2003 - 05	525.1623
Sportsman 700 4x4 / Twin	2002 - 04	525.1623
Sportsman MV7	2005	525.1623
Sportsman 800 EFI	2005 - 07	525.1623
Sportsman X2 800 EFI	2007	525.1623

Bearings

Braking

Bullbars

Cables

Carburettor

Driveline

Electrical

Exhausts

STEERING BEARING KITS



Yamaha - Utility ATV

Model	Year	
YFB250FW Timberwolf	1994 - 00	525.1515
YFM350 Grizzly IRS	2007 - 11	525.1515
YFM350A/FA AB Bruin	2004 - 06	525.1515
YFM350 Grizzly 4WD / 2WD	2007 - 13	525.1515
YFM350FW Big Bear	1987 - 97	525.1515
YFM350U Big Bear	1996 - 99	525.1515
YFM35FX / X Wolverine	1995 - 09	525.1515
YFM400 Big Bear 2WD	2000 - 04	525.1515
YFM400 Big Bear 4WD	2000 - 06	525.1515
YFM400 Big Bear IRS	2007 - 12	525.1515
YFM400 Grizzly IRS	2007 - 08	525.1515
YFM400 Kodiak 2WD	2000 - 04	525.1515
YFM400 Kodiak 4WD	1993 - 99	525.1515
YFM400 Kodiak 4WD	2000 - 06	525.1515
YFM450 Grizzly EPS	2011 - 14	525.1515
YFM450 Grizzly IRS	2007 - 14	525.1515
YFM450 Kodiak	2003 - 06	525.1515
YFM45FX Wolverine 450 4X4	2006 - 10	525.1515
YFM550 Grizzly	2009 - 14	525.1515
YFM600 Grizzly	1998 - 02	525.1515
YFM660 Grizzly	2002 - 08	525.1515
YFM700 Grizzly	2007 - 14	525.1515

Yamaha - Sport ATV

Model	Year	
YFM350 Raptor	2004 - 13	525.1515
YFM350 Warrior	1988 - 04	525.1515
YFZ350 Banshee	1987 - 06	525.1515
YFZ450	2004 - 13	525.1515
YFZ450R	2009 - 14	525.1515
YFM660R Raptor	2001 - 05	525.1515
YFM700R Raptor	2006 - 14	525.1515

STEERING BEARING KITS

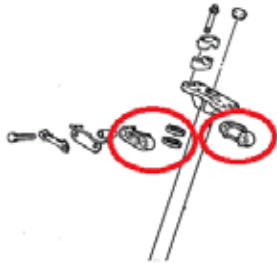

Yamaha - Top Steering Bushing & Seal Kit

Model	Year
Badger	1992-02
Banshee	1987-06
Blaster	1988 - 06
YFM 125 Breeze	1989 - 04
YFM 125 Grizzly	2005 - 09
YFM250 Bear Tracker	1999 - 03
YFM250 Bruin	2005 - 06
YFM250 Big Bear	2007 - 09
YFM350 Bruin	2004 - 06
YFM350 Big Bear	1988 - 99
YFM350 Grizzly	2007 - 09
YFM350 Grizzly IRS	2007 - 09
YFM400 Big Bear	1996 - 09
YFM600 Grizzly	1998 - 01
YFM700 Grizzly	2007-13

Plus Many More Yamaha Applications use the same OEM number 1UY-23812-00

ATV CITY P/N 522.5000

Yamaha Top Steering Bush
 Part Number 522.5000
 Oem Ref # 1UY-23812-00
 Each Kit Contains 2 Bushes
 & 2 Seals

Bearings

Braking

Bullbars

Cables

Carburettor

Driveline

Electrical

Exhausts



KING PIN KITS



Honda

King Pin Kit	Model No	Year
542.1012	TRX90	1993 - 13
542.1012	TRX125	1987 - 88
542.1010	TRX200SX	1987
542.1013	TRX200/D	1990 - 97

Kawasaki

King Pin Kit	Model No	Year
542.1006	KFX50	2003 - 06
542.1005	KFX80	2003 - 06
542.1011	KLF220 Bayou	1988 - 11
542.1011	KLF250 Bayou	2003 - 11

Suzuki

King Pin Kit	Model No	Year
542.1006	LT-50	1984 - 87
542.1006	LT-A50	2002 - 05
542.1005	LT-Z50	2006 - 09
542.1005	LT-80	1987 - 06
542.1007	LT-125 / 160 / 185	1983 - 04

Yamaha

King Pin Kit	Model No	Year
542.1002	YFM50 Raptor	2004 - 08
542.1002	YFM80 Raptor	2002 - 08
542.1001	YFM80	1985 - 88
542.1002	YFM80 Badger	1992 - 01
542.1002	YFM80 Grizzly	2005 - 08
542.1001	YFM100	1987 - 91
542.1002	YFA1	1991 - 04
542.1002	YFM125 Grizzly	2004 - 13
542.1003	YFM200 Moto-4	1985 - 89
542.1003	YFM225 Moto-4	1986 - 88
542.1004	YFM250 Moto-4	1989 - 91
542.1003	YFM350ER Moto-4	1987 - 88
542.1004	YFM350ER Moto-4	1989 - 95

TIE ROD KITS



Arctic Cat - Utility ATV

Model No	Year	Tie Rod End Kit	Tie Rod End Kit outer only	Tie Rod End Kit, Left Hand Side, Inner and Outer	Tie Rod End Kit, Right Hand Side, Inner and Outer
50 Y-6 Youth	2004 - 05	551.1003			
50 Y-6 Youth	2006	551.1026			
90 Y-12 Youth	2002 - 05	551.1003			
90 Y-12 Youth	2006	551.1026			
150 Utility	2009 - 13	551.1016			
250 2x4	1999 - 05	551.1027			
250 2x4	2006 - 09	551.1016			
250 4x4	2001 - 05	551.1027			
DVX250	2006 - 08	551.1016			
300 2x4	1998 - 04	551.1027			
300 2x4	2010 - 12	551.1016			
300 4x4	1998 - 05	551.1027			
DVX300	2009 - 12	551.1016			
366 FIS w/AT	2008 - 11	551.1027			
375 2x4 / 4x4 w/AT	2002	551.1027			
400 2x4	1998 - 01	551.1027			
400 4x4 FIS / TRV / TBX / VP	1998 - 12	551.1027			
450i EFI, TRV, GT, H1	2012	551.1027			
454 2x4 / 4x4	1997 - 98	551.1027			
500 4x4 FIS / TBX / TRV / XT / EFI	1998 - 13	551.1027			
550 GT EFI / H1 / TRV / XT / FIS	2009 - 13	551.1027			
650 4x4	2004 - 12	551.1027			
700 - Diesel / EFI / GT / TRV / XT / LTD	2007-13	551.1027			
1000 Cruiser / TRV / XT / LTD / H2	2008 - 13	551.1027			

Arctic Cat - Sport ATV

Model No	Year	Tie Rod End Kit	Tie Rod End Kit outer only	Tie Rod End Kit, Left Hand Side, Inner and Outer	Tie Rod End Kit, Right Hand Side, Inner and Outer
400 DVX	2004 - 08	551.1016			



TIE ROD KITS



Can Am - Utility ATV

Model No	Year	Tie Rod End Kit	Tie Rod End Kit outer only	Tie Rod End Kit, Left Hand Side, Inner and Outer	Tie Rod End Kit, Right Hand Side, Inner and Outer
Outlander 330	2004 - 05	551.1009			
Outlander 400	2003 - 14	551.1009			
Outlander 500	2007 - 14	551.1009			
Renegade 500	2008 - 12	551.1009			
Renegade 500	2013 - 14	551.1034			
Traxter 500	1999 - 05	551.1034			
Outlander 650	2007 - 12	551.1009			
Outlander 650	2013 - 14	551.1034			
Quest 650	2002 - 04	551.1034			
Traxter 650	2004-05	551.1034			
Outlander 800	2013 - 14	551.1034			
Outlander 800 / Power Steering / -MAX	2006 - 12	551.1009			
Outlander STD XT 800R	2012	551.1034			
Renegade 800	2007 - 11	551.1009			
Renegade 800	2012 - 14	551.1034			
Outlander 1000	2013 - 14	551.1034			
Outlander STD XT 1000	2012 - 14	551.1034			
Renegade 1000	2012 - 14	551.1034			

Can Am - Sport ATV

Model No	Year	Tie Rod End Kit	Tie Rod End Kit outer only	Tie Rod End Kit, Left Hand Side, Inner and Outer	Tie Rod End Kit, Right Hand Side, Inner and Outer
DS650	2000-07	551.1034			

Can Am - UTV

Model No	Year	Tie Rod End Kit	Tie Rod End Kit outer only	Tie Rod End Kit, Left Hand Side, Inner and Outer	Tie Rod End Kit, Right Hand Side, Inner and Outer
Commander 800	2011		551.1037-S	551.1046-L	551.1046-R
Commander 800	2012		551.1048	551.1047-L	551.1047-R
Commander 800	2013		551.1049	551.1048-L	551.1048-R
Commander 1000	2011		551.1037-S	551.1046-L	551.1046-R
Commander 1000	2012		551.1048	551.1047-L	551.1047-R
Commander 1000	2013		551.1049	551.1048-L	551.1048-R
Maverick 1000	2013		551.1054	551.1054-L	551.1054-R



Outer Tie Rod End Kits
(2 required per vehicle)

Rebuild Kits (Includes HD Inner
Et Outer Rod Ends Et Boot)

TIE ROD KITS



Honda - Utility ATV

Model No	Year	Tie Rod End Kit	Tie Rod End Kit outer only	Tie Rod End Kit, Left Hand Side, Inner and Outer	Tie Rod End Kit, Right Hand Side, Inner and Outer
TRX90	1993 - 13	551.1001			
TRX200/D	1990 - 97	551.1008	541.1015		
TRX200SX	1987	551.1001			
TRX250 Fourtrax	1985 - 86	551.1001			
TRX250 Fourtrax	1987	551.1005			
TRX250 Recon	1997 - 14	551.1008	541.1015		
TRX250EX Sportrax	2001 - 14	551.1008	541.1015		
TRX300 2wd / 4wd Fourtrax 300	1988 - 00	551.1008	541.1015		
TRX350D	1986 - 89	551.1003			
TRX350FE/FM/TE/TM	2000 - 06	551.1008	541.1015		
TRX400FA/FGA	2004 - 07	551.1008	541.1015		
TRX400FW Fourtrax Foreman 4X4	1995 - 03	551.1008	541.1015		
TRX420 FA/FM/FE/TM/TE	2009 - 14	551.1008	541.1015		
TRX450FE/FM/S/ES	1998 - 04	551.1008	541.1015		
TRX500FA	2001 - 14	551.1053	541.1015		
TRX500FE/FM	2005-14	551.1053	541.1015		
TRX650 Rincon	2003 - 05	551.1053	541.1015		
TRX680 Rincon	2006 - 14	551.1053	541.1015		

Honda - Sport ATV

Model No	Year	Tie Rod End Kit	Tie Rod End Kit outer only	Tie Rod End Kit, Left Hand Side, Inner and Outer	Tie Rod End Kit, Right Hand Side, Inner and Outer
TRX250R	1986 - 89	551.1006			
TRX250X	1987 - 92	551.1006			
TRX300 EX	1993 - 09	551.1006			
TRX400EX	1999 - 14	551.1006			
TRX400X	2012 - 13	551.1006			
TRX450ER	2006 - 14	551.1006			
TRX450R	2004 - 09	551.1006			



TIE ROD KITS



Kawasaki - Utility ATV

Model No	Year	Tie Rod End Kit	Tie Rod End Kit outer only	Tie Rod End Kit, Left Hand Side, Inner and Outer	Tie Rod End Kit, Right Hand Side, Inner and Outer
KLF220 Bayou	1988 - 11	551.1012			
KLF250 Bayou	2003 - 11	551.1012			
KLF300C Bayou 4X4	1989 - 04	551.1012			
KVF300 Brute Force	2012 - 13	551.1016			
KVF300A / B Prairie 4x4	1999 - 00	551.1012			
KVF300A / B Prairie 4x4	2001 - 02	551.1013			
KVF360A / B / C Prairie 4x4	2003 - 13	551.1009			
KLF400 Bayou	1993 - 99	551.1012			
KVF400A / B / C / D Prairie 4x4	1997 - 00	551.1012			
KVF400C / D Prairie	2001 - 02	551.1013			
KVF650 Brute force	2005 - 13	551.1023			
KVF650 i Brute force	2006 - 13	551.1006			
KVF650 Prairie	2002 - 03	551.1023			
KFX700 V-Force	2004 - 09	551.1024			
KVF700 Prairie	2004 - 06	551.1023			
KVF750 Brute Force	2005 - 14	551.1006			

Kawasaki - Sport ATV

Model No	Year	Tie Rod End Kit	Tie Rod End Kit outer only	Tie Rod End Kit, Left Hand Side, Inner and Outer	Tie Rod End Kit, Right Hand Side, Inner and Outer
KFX50	2003 - 06	551.1004			
KFX80	2003 - 06	551.1014			
KSF250 Mojave	1987 - 04	551.1012			
KEF300 Lakota	1995 - 03	551.1012			
KFX400	2003	551.1012			
KFX400	2004 - 06	551.1016			
KFX450R	2008 - 14	551.1028			

Kawasaki - UTV

Model No	Year	Tie Rod End Kit	Tie Rod End Kit outer only	Tie Rod End Kit, Left Hand Side, Inner and Outer	Tie Rod End Kit, Right Hand Side, Inner and Outer
TERYX 750 4X4	2008 - 13		551.1045	551.1044-L	551.1044-R

Outer Tie Rod End Kits
(2 required per vehicle)

Rebuild Kits (Includes HD Inner
& Outer Rod Ends & Boot)

TIE ROD KITS



Polaris - Utility ATV

Model No	Year	Tie Rod End Kit	Tie Rod End Kit outer only	Tie Rod End Kit, Left Hand Side, Inner and Outer	Tie Rod End Kit, Right Hand Side, Inner and Outer
Sportsman 90	2001 - 06	551.1026			
Sportsman 90	2007 - 14	551.1016			
Phoenix 200	2006-09	551.1012			
Sawtooth 200	2007 - 14	551.1012			
Trail Blazer 250	1990 - 95	551.1020			
Trail Blazer 250	1996	551.1022			
Trail Blazer 250	1997 - 06	551.1021			
Trail Boss 250	1988 - 99	551.1020			
Trail Boss 250 4x4	1987 - 88	551.1020			
Trail Boss 250 4x4	1989 - 93	551.1022			
Xplorer 250 4X4	2000 - 02	551.1021			
300 2x4	1994 - 95	551.1020			
300 4X4	1994	551.1022			
Hawkeye 2x4	2006 - 11	551.1033			
Hawkeye 4x4	2006 - 07	551.1033			
Sportsman 300 4X4	2008 - 10	551.1033			
Trail Boss 300 4X4	1995	551.1022			
Xplorer 300 4x4	1996 - 97	551.1022			
Xplorer 300 4x4	1998 - 99	551.1021			
Xpress 300	1996 - 97	551.1022			
Xpress 300	1998 - 99	551.1021			
Magnum 325	2000 - 02	551.1021			
Trail Boss 325	2000 - 02	551.1021			
Xpedition 325	2000 - 02	551.1021			
ATP 330 4X4	2004 - 05	551.1021			
Magnum 330	2003 - 05	551.1021			
Trail Blazer 330	2008-13	551.1021			
Trail Boss 330	2003 - 04	551.1021			
Trail Boss 330	2005 - 13	551.1021			
Sportsman 335	1999-00	551.1021			
Worker 335	1999	551.1021			
Sportsman 350 4x4	1993	551.1022			
Scrambler 380 2x4	2000	551.1021			
400L 2x4	1994-95	551.1020			
400L 4x4	1994	551.1022			
Hawkeye 400 HO 2x4	2012 - 14	551.1021			
Scrambler 400 2x4	2001 - 02	551.1021			
Scrambler 400 4x4	1995 - 96	551.1022			
Scrambler 400 4x4	1997 - 02	551.1021			
Sportsman 400 4x4	1994 - 97	551.1022			
Sportsman 400 4x4	2001 - 05	551.1021			
Sportsman 400 HO 4x4	2008 - 10	551.1033			
Sportsman 400 HO 4x4	2011 - 14	551.1021			

TIE ROD KITS



Polaris - Utility ATV Cont.

Model No	Year	Tie Rod End Kit	Tie Rod End Kit outer only	Tie Rod End Kit, Left Hand Side, Inner and Outer	Tie Rod End Kit, Right Hand Side, Inner and Outer
Trail Blazer 400	2003	551.1021			
Xplorer 400L 4x4 / 4x4	1995 - 97	551.1022			
Xplorer 400L 4x4	1998 - 02	551.1021			
Magnum 425 2x4	1995	551.1020			
Magnum 425 2x4	1996 - 97	551.1022			
Magnum 425 2x4	1998	551.1021			
Magnum 425 4x4	1995 - 98	551.1022			
Xpedition 425	2000 - 02	551.1021			
Sportsman 450	2006 - 07	551.1021			
Diesel 455 4x4	1999 - 01	551.1021			
ATP 500 4X4	2004 - 05	551.1021			
ATV 500 Pro	2002	551.1021			
Magnum 500 4x4	1999 - 03	551.1021			
PTV Series 10 4x4	2003	551.1021			
Scrambler 500 2x4/ 4x4	2000 - 12	551.1021			
Sportsman 500 4x4	1996 - 13	551.1022			
Worker 500 4x4	1999 - 02	551.1021			
Xplorer 500	1997	551.1022			
Sportsman 550	2010 - 14	551.1050			
XP 550	2009	551.1051			
XP550	2010	551.1050			
Sportsman 570	2014	551.1021			
Sportsman 600 4x4	2003 - 05	551.1021			
Sportsman 700 4x4	2002 - 08	551.1021			
Sportsman 800 EFI	2005 - 14	551.1021			
Scrambler HO/ EPS 850	2013 - 14	551.1050			
Sportsman / XP 850	2010 - 14	551.1050			

Polaris - Sport ATV

Model No	Year	Tie Rod End Kit	Tie Rod End Kit outer only	Tie Rod End Kit, Left Hand Side, Inner and Outer	Tie Rod End Kit, Right Hand Side, Inner and Outer
Predator 50	2004 - 07	551.1026			
Scrambler 50	2001 - 03	551.1026			
Outlaw 90	2007 - 14	551.1016			
Predator 90	2003 - 06	551.1026			
Scrambler 90	2001 - 03	551.1026			
Sport 400	1997 - 99	551.1021			
Outlaw 450	2008 - 10	551.1051			
Outlaw500	2006 - 07	551.1036			
Predator 500	2003 - 06	551.1025			
Predator 500	2007	551.1051			
Outlaw 525 IRS	2007 - 08	551.1036			
Outlaw 525 IRS	2009 - 11	551.1051			

TIE ROD KITS



Outer Tie Rod End Kits
(2 required per vehicle)

Rebuild Kits (Includes HD Inner
Et Outer Rod Ends Et Boot)



Polaris - UTV

Model No	Year	Tie Rod End Kit	Tie Rod End Kit outer only	Tie Rod End Kit, Left Hand Side, Inner and Outer	Tie Rod End Kit, Right Hand Side, Inner and Outer
LSV Electric 4X4	2011 - 12		551.1030	551.1039-L	551.1039-R
Ranger EV 4X4	2010 - 13		551.1030	551.1039-L	551.1039-R
Big Boss 250 4x6	1989 - 92	551.1020			
Big Boss 250 6x6	1991 - 93	551.1022			
Big Boss 300 6x6	1994	551.1022			
Big Boss 350L 6x6	1993	551.1022			
Big Boss 400L 6x6	1994 - 97	551.1022			
Magnum 400L 6x6	1996 - 97	551.1022			
Ranger 4x4 400	2010 - 14		551.1030	551.1039-L	551.1039-R
Big Boss 500 6x6	1998 - 03	551.1021			
PTV Series 10 6X6	2003	551.1021			
Ranger 2x4 500	2008 - 09		551.1030	551.1040-L	551.1040-R
Ranger 4x4 500	1999		551.1030		
Ranger 4x4 500	2004		551.1030		
Ranger 4x4 500	2005 - 08		551.1030	551.1040-L	551.1040-R
Ranger 4x4 500	2009 - 10		551.1030	551.1041-L	551.1041-R
Ranger 4x4 500	2011 - 13		551.1030	551.1039-L	551.1039-R
Ranger 4x4 500 Crew	2011 - 13		551.1030	551.1039-L	551.1039-R
Ranger 6X6 500	2002 - 04		551.1030		
Ranger Series 10 Et 11 4x4 Et 6x6	2007		551.1030		
Sportsman 500 6x6	2000 - 08	551.1021			
Ranger RZR 570 EFI	2012 - 14		551.1030	551.1039-L	551.1039-R
Ranger 4x4 700	2005 - 08		551.1030	551.1040-L	551.1040-R
Ranger 4x4 700	2009		551.1030	551.1041-L	551.1041-R
Ranger 4x4 700 CREW	2008 - 09		551.1030	551.1040-L	551.1040-R
Ranger 6x6 700 EFI	2006 - 09		551.1030	551.1040-L	551.1040-R
Ranger 4x4 800 EFI	2010 - 13		551.1030	551.1041-L	551.1041-R
Ranger 4x4 800 EFI Crew	2010		551.1030		
Ranger 4x4 800 EFI Crew	2011 - 14		551.1030	551.1041-L	551.1041-R
Ranger 4x4 800 EFI Midsize	2013		551.1030	551.1039-L	551.1039-R
Ranger 6X6 800	2010		551.1030		
Ranger 6X6 800	2011 - 14		551.1030	551.1041-L	551.1041-R
Ranger 800 Crew	2013		551.1030	551.1041-L	551.1041-R
Ranger RZR 4/EPS RGE	2011		551.1030	551.1042-L	551.1042-R
Ranger RZR 4 800	2013		551.1030	551.1042-L	551.1042-R
Ranger RZR S 800	2009 - 13		551.1030	551.1042-L	551.1042-R
Ranger XP 800	2012		551.1030	551.1041-L	551.1041-R
RZR 800	2008 - 13		551.1030	551.1043-L	551.1043-R

Bearings

Braking

Bullbars

Cables

Carburettor

Driveline

Electrical

Exhausts

TIE ROD KITS



Outer Tie Rod End Kits
(2 required per vehicle.)

Rebuild Kits (Includes HD Inner
& Outer Rod Ends & Boot.)

Polaris - UTV Cont.

Model No	Year	Tie Rod End Kit	Tie Rod End Kit outer only	Tie Rod End Kit, Left Hand Side, Inner and Outer	Tie Rod End Kit, Right Hand Side, Inner and Outer
Sportsman Forest 800 6x6	2013	551.1021			
Ranger 4x4 Crew Diesel 900	2012		551.1030	551.1042-L	551.1042-R
Ranger 4x4 Diesel 900	2011 - 14		551.1030	551.1041-L	551.1041-R
Ranger 900 XP	2013 - 14		551.1030	551.1042-L	551.1042-R
Ranger Diesel 900 Crew	2013 - 14		551.1030	551.1041-L	551.1041-R
Ranger RZR 4 XP 900	2012 - 14		551.1030	551.1049-L	551.1049-R
Ranger RZR XP 900	2011 - 13		551.1030	551.1049-L	551.1049-R
Magnum 400L 6x6	1996 - 97	551.1022			
Ranger 4x4 400	2010 - 13		551.1030	551.1039-L	551.1039-R

Suzuki - Utility ATV

Model No	Year	Tie Rod End Kit	Tie Rod End Kit outer only	Tie Rod End Kit, Left Hand Side, Inner and Outer	Tie Rod End Kit, Right Hand Side, Inner and Outer
LT-50	1984 - 87	551.1012			
LT-A50	2002 - 05	551.1004			
LT-160	1991 - 04	551.1002			
LT-F230	1986 - 87	551.1014			
LT-250EF	1985 - 86	551.1014			
LT-4WD 250	1987 - 98	551.1015			
LT-F250	1988 - 01	551.1014			
LT-F250 Ozark	2002 - 03	551.1014			
LT-F250 Ozark	2004 - 13	551.1016			
LT-F250F (Except Ozark)	1997 - 02	551.1015			
LT-Z250	2004 - 09	551.1016			
LT-300E	1987 - 89	551.1014			
LT-F300F King Quad	1991 - 02	551.1015			
LT-A/LT-F400 King Quad	2008 - 13	551.1016			
LT-A400 Eiger 2wd / 4wd	2002 - 04	551.1014			
LT-A400F Eiger 4wd / 2wd	2005 - 07	551.1016			
LTA-450 X King Quad	2007 - 10	551.1029			
LT-A500F Quad Master Auto	2000 - 01	551.1032			
LT-A/LT-F500F Vinson	2002 - 03	551.1012			
LT-A/LT-F500F Vinson	2004 - 07	551.1016			
LT-A500X	2009 - 10	551.1028			
LT-A500X	2011 - 13	551.1029			
LT-F500F	1998 - 02	551.1032			
LTA-700 X King Quad	2005 - 07	551.1029			

TIE ROD KITS



Suzuki - Utility ATV Cont.

Model No	Year	Tie Rod End Kit	Tie Rod End Kit outer only	Tie Rod End Kit, Left Hand Side, Inner and Outer	Tie Rod End Kit, Right Hand Side, Inner and Outer
LTV-700F Twin Peaks	2004 - 06	551.1023			
LTA-750 X King Quad	2008 - 13	551.1029			
LTA-750 XP King Quad Power Steering	2011 - 13	551.1028			

Suzuki - Sport ATV

Model No	Year	Tie Rod End Kit	Tie Rod End Kit outer only	Tie Rod End Kit, Left Hand Side, Inner and Outer	Tie Rod End Kit, Right Hand Side, Inner and Outer
LT-Z50	2006 - 09	551.1004			
LT-80	1987 - 06	551.1014			
LT-Z90 QUADSPORT	2007 - 09	551.1004			
LT-250R	1985 - 92	551.1014			
LT-250S	1989 - 90	551.1014			
LT-Z400	2003	551.1012			
LT-Z400	2004 - 08	551.1016			
LT-Z400	2009 - 13	551.1028			
LT-R450	2006 - 11	551.1028			
LT-500R	1987 - 90	551.1017			

Yamaha - Utility ATV

Model No	Year	Tie Rod End Kit	Tie Rod End Kit outer only	Tie Rod End Kit, Left Hand Side, Inner and Outer	Tie Rod End Kit, Right Hand Side, Inner and Outer
YFM80	1985 - 88	551.1011			
YFM80 Badger	1992 - 01	551.1011			
YFM80 Grizzly	2005 - 08	551.1011			
YFM100	1987 - 91	551.1011			
YFA1	1991 - 04	551.1016			
YFM125 Grizzly	2004 - 13	551.1016			
YFM200 Moto-4	1985	551.1010			
YFM200 Moto-4	1986 - 89	551.1016			
YFM225 Moto-4	1986 - 88	551.1016			
YFB250 / FW Timberwolf	1992 - 00	551.1016			
YFM250 Beartracker	1999 - 04	551.1007			
YFM250 Big Bear	2007 - 09	551.1007			
YFM250 Moto-4	1989 - 91	551.1016			
YFM250B Bruin	2005 - 06	551.1007			
YFM350 Grizzly 4WD	2013	551.1016			

TIE ROD KITS



Yamaha - Utility ATV Cont.

Model No	Year	Tie Rod End Kit	Tie Rod End Kit outer only	Tie Rod End Kit, Left Hand Side, Inner and Outer	Tie Rod End Kit, Right Hand Side, Inner and Outer
YFM350 Grizzly IRS	2007 - 11	551.1007			
YFM350A/ AB / FA Bruin 2WD / 4WD	2004-06	551.1007			
YFM350ER Moto-4	1987 - 95	551.1016			
YFM350FGW Grizzly 4WD	2007 - 11	551.1007			
YFM350FW Big Bear	1987 - 99	551.1016			
YFM350GW Grizzly 2WD	2007-11	551.1007			
YFM350FGW Grizzly	2012 - 14	551.1016			
YFM350U Big Bear	1996 - 99	551.1016			
YFM35FX Wolverine	1995 - 05	551.1016			
YFM35X Wolverine	2006 - 09	551.1007			
YFM400 Big Bear 2WD	2000 - 04	551.1007			
YFM400 Big Bear 4WD	2000 - 06	551.1007			
YFM400 Big Bear IRS	2007 - 12	551.1007			
YFM400 Grizzly IRS	2007 - 08	551.1007			
YFM400 Kodiak 2WD	2000 - 01	551.1016			
YFM400 Kodiak 2WD / 4WD	2003 - 04	551.1007			
YFM400 Kodiak 4WD	1993 - 02	551.1016			
YFM400 Kodiak 4WD	2005 - 06	551.1031			
YFM450 Grizzly EPS	2013	551.1016			
YFM450 Grizzly IRS	2007 - 12	551.1031			
YFM450 Grizzly IRS	2013 - 14	551.1016			
YFM450 Kodiak	2003 - 04	551.1007			
YFM450 Kodiak	2005 - 06	551.1031			
YFM45FX Wolverine 450 4X4	2006 - 10	551.1007			
YFM550 Grizzly	2009 - 14	551.1016			
YFM600 Grizzly	1998 - 02	551.1016			
YFM660 Grizzly	2002 - 08	551.1016			
YFM700 Grizzly	2007 - 14	551.1016			

Yamaha - Sport ATV

Model No	Year	Tie Rod End Kit	Tie Rod End Kit outer only	Tie Rod End Kit, Left Hand Side, Inner and Outer	Tie Rod End Kit, Right Hand Side, Inner and Outer
YFM50 Raptor	2004 - 08	551.1011			
YFM80 Raptor	2002 - 08	551.1011			
YFM90 Raptor	2009 - 13	551.1026			
YFM125 Raptor	2011 - 13	551.1016			
YFS200 Blaster	1988 - 06	551.1016			
YFM 250 Raptor	2008 - 13	551.1016			

TIE ROD KITS



Yamaha - Sport ATV Cont.

Model No	Year	Tie Rod End Kit	Tie Rod End Kit outer only	Tie Rod End Kit, Left Hand Side, Inner and Outer	Tie Rod End Kit, Right Hand Side, Inner and Outer
YFM350 Raptor	2004 - 13	551.1016			
YFM350 Warrior	1987 - 04	551.1016			
YFZ350 Banshee	1987 - 06	551.1016			
YFZ450	2004 - 05	551.1016			
YFZ450	2006 - 13	551.1028			
YFZ450R	2009 - 14	551.1028			
YFZ450X	2010 - 11	551.1028			
YFM660R Raptor	2001 - 05	551.1016			
YFM700R Raptor	2006 - 13	551.1028			

Yamaha - UTV

Model No	Year	Tie Rod End Kit	Tie Rod End Kit outer only	Tie Rod End Kit, Left Hand Side, Inner and Outer	Tie Rod End Kit, Right Hand Side, Inner and Outer
450 RHINO	2006 - 09		551.1037-S	551.1038	551.1038
660 RHINO	2004 - 07		551.1037-S	551.1038	551.1038
700 RHINO FI	2008 - 13		551.1037-S	551.1038	551.1038
700 VIKING	2014		551.1037-S		

Outer Tie Rod End Kits
(2 required per vehicle)

Rebuild Kits (Includes HD Inner
& Outer Rod Ends & Boot)





the best part of your atv

- 1: BEARINGS, BUSH KITS, BALLJOINTS
- 2: BRAKING
- 3: BULLBARS, MUDFLAP KITS
- 4: CABLES
- 5: CARBURETTOR PARTS
- 6: DRIVE LINE / CVT BELTS / AXLES
- 7: ELECTRICAL
- 8: EXHAUSTS
- 9: MISCELLANEOUS
- 10: FILTERS
- 11: SEAT COVERS, OVER COVERS
- 12: TOOLS
- 13: TYRES / TUBES / RIMS
- 14: ENGINE COMPONENTS
- 15: SPRAYERS & SPRAYER ACCESSORIES



2: BRAKING

BRAKE PADS/SHOES AND DISCS



Adly

Make & Model	Year	Left / Right	Front Brake Pad/Shoe	Brake Disc - Front	Rear Brake Pad/Shoe	Brake Disc - Rear
Crossroad 220 Sentinel Quad			250.H1085			
Hurricane 280 Quad	08-09		250.H1085			
Canyon 280 / 300 Quad	08-09		250.H1085			
Crossroad 300 Sentinel Quad	08-09		250.H1085			
Hurricane 300 Quad	08-09		250.H1085			
300 RS Quad	07-08		250.H1085			
300 XS Quad	07-08		250.H1085			
Utility 300	05-07		250.H1085			
320 S Quad	08		250.H1085			
Hurricane 320 Quad	08-09		250.H1085			
500 S	08		250.H1085			

Aeon

Make & Model	Year	Left / Right	Front Brake Pad/Shoe	Brake Disc - Front	Rear Brake Pad/Shoe	Brake Disc - Rear
Overland 125	02-06				250.Y2032	
Cobra RS 180	06				250.Y2032	
Overland 180	02-11				250.Y2032	
Cobra 220	06-11				250.K5020	
Overland 300	06-07				250.K5020	
Cube X4 350 - Side X Side	11					
Cobra 350	10-11				250.K5020	
Cobra 400	10-11				250.K5020	
Overland 600	11		250.H1085		250.K5020	

Apache

Make & Model	Year	Left / Right	Front Brake Pad/Shoe	Brake Disc - Front	Rear Brake Pad/Shoe	Brake Disc - Rear
RLX 320 Utility			250.K5020		250.K5020	
RLX 450 S			250.K5020		250.K5020	

BRAKE PADS/SHOES AND DISCS

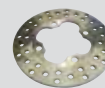

Arctic Cat (ATV)

Make & Model	Year	Left / Right	Front Brake Pad/Shoe	Brake Disc - Front	Rear Brake Pad/Shoe	Brake Disc - Rear
250 2 X 4 / 4 x 4 Utility	05-09		250.07088		250.07088	
250 DVX Sport	06-08		250.H1085			
300 4 X 4 Utility	05		250.07088		250.07088	
300 ATV	10-12		250.07088		250.07088	
300 DVX	09-12		250.H1085			
350 ATV	12		250.07088		250.07088	
366 4 X 4 Auto Utility / SE	08-10		250.07088		250.07088	
400 4 X 4 Utility	05-07		250.07088		250.07088	
400 DVX Sport	04-08		250.S3030		250.S3036	
400 TRV	09-10		250.07088		250.07088	
400 4X Auto TRV Multirider	06-07		250.07088		250.07088	
425i	12		250.07088		250.07088	
450 H1 Efi / GT / TRV	10-12		250.07088		250.07088	
XC450i	11-12		250.07088		250.07088	
500 4 x 4 Utility	05-09		250.07088		250.07088	
550 HI EFi	09-10		250.07088		250.07088	
500 4 x 4 Auto TRV Multirider	05-08		250.07088		250.07088	
550 HI EFi LE / TRV / GT / LTD	09-12		250.07088		250.07088	
650 H1 / TRV / TBX / V2	04-12		250.07088		250.07088	
700 Diesel Utility / GT / TRV / EFi / S	07-12		250.07088		250.07088	
1000 GT / TRV / H2 / Thundercat	09-12		250.07088		250.07088	

Arctic Cat (Side x Side)

Make & Model	Year	Left / Right	Front Brake Pad/Shoe	Brake Disc - Front	Rear Brake Pad/Shoe	Brake Disc - Rear
550 Hi EFi Prowler	09		250.07088		250.07088	
XT 550 / Prowler	10-12		250.07088		250.07088	
XT 650 H1 Prowler	06-09		250.07088		250.07088	
XTX / HDX 700 Hi LE Prowler	08-12		250.07088		250.07088	
WILDCAT 1000i H.O.	12		250.07088		250.07088	
XTZ 1000 I / H2 Prowler	09-12		250.07088		250.07088	

Ausa

Make & Model	Year	Left / Right	Front Brake Pad/Shoe	Brake Disc - Front	Rear Brake Pad/Shoe	Brake Disc - Rear
M50D			250.07053		250.07053	
M50D Handbrake			250.07044		250.Y2049	



BRAKE PADS/SHOES AND DISCS



Bombardier/BRP

Make & Model	Year	Left / Right	Front Brake Pad/Shoe	Brake Disc - Front	Rear Brake Pad/Shoe	Brake Disc - Rear
DS 250	06		250.H1085		250.H1085	
Rally 200	05-07				250.Y2032	
Outlander 330 HO	04-05	Left	250.Y2049		250.Y2049	
	04-05	Right	250.07064			
Outlander 400 (7535/7716)	03-04	Left	250.Y2049		250.Y2049	
	03-04	Right	250.07064			
Outlander 400 Max HO	03-06	Left	250.Y2049		250.Y2049	
	03-06	Right	250.07064			
Outlander 650 / MAX / HO Efi 4x4/HO Efi XT 4x4	06	Left	250.Y2049		250.Y2049	
	06	Right	250.07064			
Outlander 800	06	Left	250.Y2049		250.Y2049	
	06	Right	250.07064			
Traxter / XL / XT /Auto / Foot (4x4)	99-01		250.07053		250.07053	
Traxter / XL / XT /Auto / Foot (4x4)	01-05	Left	250.Y2049		250.Y2049	
	01-05	Right	250.07064			
Quest 500 (4x4)	02-04	Left	250.Y2049		250.07064	
	02-04	Right	250.07064			
Traxter Max	03-05	Left	250.Y2049		250.07064	
	03-05	Right	250.07064			
Quest 500 / 650 (2x4)	02	Left	250.Y2049		250.07064	
	02	Right	250.07064			
Quest 650 / XT / MAX (4x4)	02-04	Left	250.Y2049		250.07064	
	02-04	Right	250.07064			
DS 650 / Baja/X	00-06	Left	250.Y2049		250.Y2049	
	00-06	Right	250.07064			

Can Am (ATV)

Make & Model	Year	Left / Right	Front Brake Pad/Shoe	Brake Disc - Front	Rear Brake Pad/Shoe	Brake Disc - Rear
Outlander 500 Max/STD 4x4	2013	Left	250.07450			
		Right	250.07400		250.07450	
Renegade 500	12-13	Left	250.07450		250.07450	
		Right	250.07400		250.07400	
Outlander 650	2013	Left	250.07450			
		Right	250.07400		250.07450	
Outlander 800 R	12-13	Left	250.07450			
		Right	250.07400		250.07450	
Renegade 800	12-13	Left	250.07450		250.07450	
		Right	250.07400		250.07400	
Outlander 1000 STD / XT	12-13	Left	250.07450			
		Right	250.07400		250.07450	
Renegade 1000	12-13	Left	250.07450		250.07450	
		Right	250.07400		250.07400	

BRAKE PADS/SHOES AND DISCS

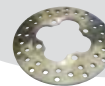

Can Am Side x Side

Make & Model	Year	Left / Right	Front Brake Pad/Shoe	Brake Disc - Front	Rear Brake Pad/Shoe	Brake Disc - Rear
Commander 800 R	11-12	Left	250.Y2032		250.S3031	
		Right	250.S3031			
Commander 1000	11-12	Left	250.Y2032		250.S3031	
		Right	250.S3031			
Commander 1000 X	11-12	Left	250.Y2032		250.S3031	
		Right	250.S3031			
Commander 1000 XT	11-12	Left	250.Y2032		250.S3031	
		Right	250.S3031			

Honda

Make & Model	Year	Left / Right	Front Brake Pad/Shoe	Brake Disc - Front	Rear Brake Pad/Shoe	Brake Disc - Rear
ATC 200 XD	83		250.S3030		250.S3030	
TRX 200 L-DN	90-93		250.MBS1130			
TRX 200 L/M	90-91		250.MBS1130			
TRX 200 D	91-97		250.MBS1130			
TRX 200 SX	86-87		250.MBS1130			
ATC 250 ESF-J	85-88				250.MBS1105	
TRX 250 F/G/H	85-87				250.MBS1105	
TRX 250 TE/TM	97-12		250.MBS1130		250.MBS1136	
TRX 250 EX	01-08		250.S3030		250.MBS1136	
TRX 250 X	09-11		250.S3030		250.MBS1136	
TRX 300 (2WD)	88-00		250.MBS1130		250.MBS1105	
TRX 300 FW (4WD)	88-00		250.MBS1129		250.MBS1105	
TRX 300 EX	93-08		250.S3030		250.S3030	
TRX 300 X9	09		250.S3030		250.S3030	
TRX 350 G-N	86-93				250.MBS1118	
TRX 350 Rancher / Fourtrax ES 4x4/2x4	00-06		250.MBS1129		250.MBS1133	
TRX 400 FW	95-00		250.MBS1129		250.MBS1133	
TRX 400 EX	99-08		250.S3030		250.S3030	
TRX 400 FA Fourtrax AT	04-07		250.MBS1129		250.MBS1133	
TRX 400 X9	09		250.S3030		250.S3030	
TRX 420 FE/FM/TE/TM - Fourtrax (Also Power Steering)	07-13		250.S3030	260.0005	250.MBS1133	
TRX 420 FA Fourtrax Auto 4WD (Also Power Steering)	09-13		250.S3030	260.0005	250.H1084	

BRAKE PADS/SHOES AND DISCS

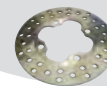

Honda Cont.

Make & Model	Year	Left / Right	Front Brake Pad/Shoe	Brake Disc - Front	Rear Brake Pad/Shoe	Brake Disc - Rear
TRX 450 ES/S/FM/FE Foreman	98-04		250.MBS1129		250.MBS1133	
TRX 450 R	04-09				250.H1084	
TRX 500 FA Fourtrax Foreman - Auto	01-04		250.MBS1129		250.MBS1118	
TRX 500 FA Fourtrax Foreman - Auto	05-11	Left	250.H1091	260.0010	250.MBS1118	
	05-11	Right	250.H1090	260.0010	250.MBS1118	
TRX 500 FAC Fourtrax Foreman AT 2/4 WD	12-13		250.S3030		250.MBS1118	
TRX 500 FE/FM Fourtrax Foreman 4WD/ES (Also Power Steering)	05-11	Left	250.H1091	260.0010	250.MBS1118	
	05-11	Right	250.H1090	260.0010	250.MBS1118	
TRX 500 FE/FMC Fourtrax Foreman ES 2/4 WD	12-13		250.S3030		250.MBS1118	
TRX 500 FPAC Fourtrax Foreman 2/4 WD	12-13		250.S3030		250.MBS1118	
TRX 650 FA Rincon	03-05		250.MBS1129		250.H1084	
TRX 680 FA Rubicon 4X4 Auto	06-10	Left	250.H1091	260.0010	250.H1084	
	06-10	Right	250.H1090	260.0010	250.H1084	
TRX 700 XX	08-12				250.H1091	

John Deere (ATV & Side x Side Models)

Make & Model	Year	Left / Right	Front Brake Pad/Shoe	Brake Disc - Front	Rear Brake Pad/Shoe	Brake Disc - Rear
Trail Buck 500/650 EX/EXT	04-05	Left	250.Y2049		250.07064	
Trail Buck 500/650 EX/EXT	04-05	Right	250.07064			
Buck 500/650 EX/EXT	04-08	Left	250.Y2049		250.07064	
Buck 500/650 EX/EXT	04-08	Right	250.07064			
TX Gator Utility 9461	04-05		250.07072		250.07072	
TX Turf Gator 9462	04-05		250.07072		250.07072	
4PX Gator 4x2/4x4 4x4 Trail 9345	04-05		250.07072		250.07072	
HPX Gator 4x2/4x4 9446	04-08		250.07072		250.07072	
HPX 4 x2 (Petrol) Gator	10-11		250.07072		250.07072	
HPX 4 x4 / 4 x 4 Trail (Petrol) - Gator	10-11		250.07072		250.07072	
HPX 4x4 (Diesel) - Gator - (SN040000)	10		250.07072		250.07072	

BRAKE PADS/SHOES AND DISCS



John Deere (ATV & Side x Side Models) Cont.

Make & Model	Year	Left / Right	Front Brake Pad/Shoe	Brake Disc - Front	Rear Brake Pad/Shoe	Brake Disc - Rear
HPX 4x4 (Diesel) - Gator - (SN040001 - 090000 / SN090001 -)	10 -11		250.HD6021		250.HD6021	
XUV 620 i (Petrol) - Gator	10		250.HD6021		250.HD6021	
XUV 625 i (Petrol) - Gator	11		250.HD6021		250.HD6021	
XUV 825 i (Petrol) - Gator	11		250.HD6021		250.HD6021	
XUV 850 D (Diesel) - Gator	10		250.HD6021		250.HD6021	
XUV 855 D (Diesel) - Gator	11		250.HD6021		250.HD6021	

Kawasaki

Make & Model	Year	Left / Right	Front Brake Pad/Shoe	Brake Disc - Front	Rear Brake Pad/Shoe	Brake Disc - Rear
KFX 50 (KSF 50 A)	03-05		250.MBS3313			
KFX 80 (KSF 80 AF)	03-06		250.MBS3313		250.MBS3315	
KLF 220 A1-A15	88-02		250.MBS4406		250.MBS4410	
KLF 250 A (Bayou 250)	03-11		250.MBS4406		250.MBS4410	
KSF 250 A(KFX 250 Mojave)	87-04			260.0105	250.S3030	
KAF 300 A1/B1/B2 (Mule 500)			250.MBS3322			
KAF 300 C1-C7/D1 (Mule 550)			250.MBS3322			
KEF 300 B1-B3 Lakota Sport	01-03			260.0105	250.S3030	
KLF 300 A Bayou	86-87				250.MBS4410	
KLF 300 B Bayou	88-04		250.K5020	260.0105	250.MBS4410	
KLF 300 C Bayou	89-05	Left	250.Y2032	260.0110	250.MBS4420	
	89-05	Right	250.S3031	260.0110		
KVF 300 A/B (Prairie 4x4 / 4x2)	99-02		250.H1012	260.0110	250.MBS4420	
KVF 360 A / B / C	03-12		250.H1012	260.0115		
	93-99	Left	250.Y2032	260.0110	250.MBS4420	
KLF 400 B Bayou	93-99	Right	250.S3031	260.0110		
	03-06		250.S3030		250.S3036	
KVF 400 A/B/C/D (Prairie 4x4 / 2x4)	97-02		250.H1012	260.0110	250.MBS4420	
KAF 450 B1 (Mule 1000)			250.MBS4417		250.MBS4421	
KFX 450 R Quad (KSF 450 B)	08-12	Left	250.K5044		250.S3030	
		Right	250.K5042			
KAF 540 C1 (Mule 2010)			250.MBS4417		250.MBS4421	
KAF 540 D1 (Mule 2020)			250.MBS4417		250.MBS4421	
KAF 540 E1 (Mule 2030)			250.MBS4417		250.MBS4421	
KAF 620 A1/A2/A3/A6 (Mule 2510)			250.MBS4417		250.MBS4421	

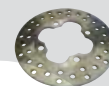

BRAKE PADS/SHOES AND DISCS



Kawasaki Cont.

Make & Model	Year	Left / Right	Front Brake Pad/Shoe	Brake Disc - Front	Rear Brake Pad/Shoe	Brake Disc - Rear
KAF 620 B1/B2/B6 (Mule 2520)			250.MBS4417		250.MBS4421	
KAF 620 C1/C2/C3/C6 (Mule 2500)			250.MBS4417		250.MBS4421	
KAF 620 E1/E2/E3/E4/E5 (Mule 3010)			250.MBS4417		250.MBS4421	
KAF 620 F1/F2 (Mule 3020)			250.MBS4417		250.MBS4421	
KAF 620 G1/G2/G3/G4/G5 Mule (3000)			250.MBS4417		250.MBS4421	
KAF 620 H1/H2/H3 (Mule 3010 4x4)			250.MBS4417		250.MBS4421	
KAF 620 J1/K1/K6F/K7F (Mule 3010 Trans 4x4)	05-07		250.MBS4417		250.MBS4421	
KAF 620 M9F/MAF/MBF/MCF (Mule 4010 Trans 4x4)	09-12		250.MBS4417		250.MBS4421	
KAF 620 N9F (Mule 4010 Trans 4x4 Hardwoods Green)	09		250.MBS4417		250.MBS4421	
KAF 620 P9F/PAF (Mule 4000)	09		250.MBS4417		250.MBS4421	
KAF 620 R/S (Mule 4010 Trans 4x4)	09-12		250.MBS4417		250.MBS4421	
KVF 650 A1/A2 Prairie	02-03	Left	250.K5044	260.0115		
	02-03	Right	250.K5042	260.0115		
KVF 650 D / E Brute Force 4x4	05-11	Left	250.K5044	260.0115		
		Right	250.K5042	260.0115		
KVF 650 E / F / H / G Brute Force 4x4 Hardwoods Green HD	08	Left	250.Y2032	260.0115		
		Right	250.S3031	260.0115		
KSV 700 A1/A2/A6F/A7F/A8F/A9F/ABF (KFX 700) V-Force	04-11	Left	250.K5044			
		Right	250.K5042			
KVF 700 B1/B6F/A7F/A8F 4x4 (Prairie) (KVF 700 A1/A2/A6F/B2)	04-08	Left	250.K5044	260.0115		
		Right	250.K5042	260.0115		
KRF 750 Teryx 750 4x4 (RUV)	08-13	Left	250.Y2032			
		Right	250.S3031			
KVF 750 D8F/D9F/DAF	08-11	Left	250.Y2032	260.0115		
		Right	250.S3031	260.0115		

BRAKE PADS/SHOES AND DISCS

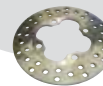

Kawasaki Cont.

Make & Model	Year	Left / Right	Front Brake Pad/Shoe	Brake Disc - Front	Rear Brake Pad/Shoe	Brake Disc - Rear
KAF 950 A1/A2/A3 (Mule 2510 Diesel)			250.MBS4417		250.MBS4421	
KAF 950 B1/B2/B3 (Mule 3010 Diesel)			250.MBS4417		250.MBS4421	
KAF 950 D8F Mule 3010 Diesel 4x4	08		250.MBS4417		250.MBS4421	
KAF 950 E8F Mule 3010 Trans Diesel 4x4	08		250.MBS4417		250.MBS4421	
KAF 950 F9F/FAF/FBF/FCF (Mule 4010 Diesel 4x4)	09-12		250.MBS4417		250.MBS4421	
KAF 950 G9F/GAF/GBF/GCF (Mule 4010 Trans 4x4 Diesel)	09-12		250.MBS4417		250.MBS4421	

Kiotti / Mechron (Side x Side)

Make & Model	Year	Left / Right	Front Brake Pad/Shoe	Brake Disc - Front	Rear Brake Pad/Shoe	Brake Disc - Rear
2200 UTV (Side x Side)	09-12		250.H1022		250.H1022	
2210 UTV (Side x Side)	11-12		250.H1022		250.H1022	

Kymco

Make & Model	Year	Left / Right	Front Brake Pad/Shoe	Brake Disc - Front	Rear Brake Pad/Shoe	Brake Disc - Rear
KXR 250 Mongoose Quad	04-07		250.H1085			
MXU 250	04-09		250.H1085			
Urban Quad 250	06		250.H1085			
Maxxer 300	06-12		250.H1085			
MXU 300	06-11		250.H1085		250.H1085	
MXU 300 R	10-12		250.H1085		250.H1085	
Maxxer 400	09-10		250.07088		250.07088	
MXU 400	08-11		250.07088		250.07088	
Maxxer 450 i	10-12		250.07088		250.07088	
MXU 450 i IRS	11-12		250.07088		250.07088	
MXU 500 (L70000 /Carb Model/4x4)	05-09		250.H1085	260.0210	250.H1085	
MXU 500 (Carb Model)	10				250.H1085	
MXU 500i (EFI Model)	10				250.H1085	
MXU 500 i DX Parking Brake	12		250.H1085			



BRAKE PADS/SHOES AND DISCS

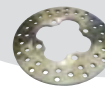

Kymco Cont.

Make & Model	Year	Left / Right	Front Brake Pad/Shoe	Brake Disc - Front	Rear Brake Pad/Shoe	Brake Disc - Rear
MXU 500 i IRS (4x4 - IRS) (LAAOCD/CM) Parking brake	09-11		250.H1085			
UXV 500 (Side x Side/4x4/ U10000)	08-09		250.H1085		250.H1085	
UXV 500 i (Side x Side/4x4/ U10100)	10-12		250.H1085		250.H1085	
MXU 550 i Parking Brake	12		250.H1085			

Massey-Ferguson (ATV)

Make & Model	Year	Left / Right	Front Brake Pad/Shoe	Brake Disc - Front	Rear Brake Pad/Shoe	Brake Disc - Rear
MF 400/4WD Auto (376cc)	05-09		250.07088		250.07088	
MF 500/4WD Auto (493cc)	05-09		250.07088		250.07088	
MF 650 2 cyl/4WD Auto (633cc)	05-09		250.07088		250.07088	
MF 650/4WD Auto (641cc)	05-09		250.07088		250.07088	
MF 700 2 D/4WD Auto (686cc Diesel)	05-08		250.07088		250.07088	

Polaris

Make & Model	Year	Left / Right	Front Brake Pad/Shoe	Brake Disc - Front	Rear Brake Pad/Shoe	Brake Disc - Rear
250 Big Boss 4 x 6 / 6 x 6	89-92		250.07036			
250 Big Boss 4 x 6 / 6 x 6 Middle Axle Brake	89-92		250.07036			
250 Trail Blazer	90-06		250.07036		250.07058	
Trail Boss 2 x 4	85-87		250.MBS2206			
Trail Boss 2 x 4 / 4 x 4	88-89		250.07036			
250 Trail Boss 2 x 4 / 4 x 4	91-92		250.07036			
250 Xplorer (4 x 4)	00		250.07036			
300 2 x 4 / 4 x 4	94-95		250.07036			
300 Big Boss 6 x 6	94		250.07036			
300 Big Boss 6 x 6 Middle Axle Brake	94		250.07036			
300 Hawkeye 2x4 / 4x4	06-07		250.07088		250.07088	
300 Hawkeye 2x4	08-09		250.07036		250.07036	
300 Sportsman (4x4)	08-10		250.07036		250.07036	

BRAKE PADS/SHOES AND DISCS



Polaris Cont.

Make & Model	Year	Left / Right	Front Brake Pad/Shoe	Brake Disc - Front	Rear Brake Pad/Shoe	Brake Disc - Rear
300 Xplorer 4 x 4	96-00		250.07036			
300 / 400 Xpress L	96-97		250.07036			
300 Xpress 2 x 4	98-00		250.07036			
325 Magnum (4 x 4) (2 x 4)	00-01		250.07036			
325 Magnum (2 x 4 / 4 x 4) HDS	02		250.07036		250.07058	
325 Trail Boss	00-02		250.07036			
325 Xpedition	00		250.07036			
325 Xpedition	02		250.07036		250.07058	
330 ATP (4x4)	04-05		250.07036		250.07036	
330 Magnum (2x4/4x4/ HDS)	03-06		250.07036		250.07058	
330 Trail Boss	03-04		250.07036			
330 Trail Boss	05-12		250.07036		250.07058	
330 Trail Blazer	08-12		250.07036		250.07058	
335 Sportsman/Worker 4 x 4	99-00		250.07036			
400 L 2 x 4 / 4 x 4	94-95		250.07036			
400 Big Boss L 6 x 6	94-97		250.07036			
400 Big Boss L 6 x 6 Middle Axle Brake	94-97		250.07036			
400 Scrambler / L 4 x 4 / 2 x 4	94-02		250.07036			
400 Sport L	94-00		250.07036			
400 Sportsman L 4 x 4	94-97		250.07036			
400 Sportsman	01-02		250.07036			
400 Sportsman 400	03-05		250.07036		250.07058	
400 Sportsman HO 4x4	08-10		250.07036		250.07036	
400 Sportsman HO 4x4	11-12		250.07036			
400 Trail Blazer	03		250.07036			
400 Xplorer	95-02		250.07036			
425 Magnum 2 x 4 / 4 x 4	95-98		250.07036			
425 Magnum 6 x 6	96-97		250.07036			
425 Magnum 6 x 6 Middle Axle Brake	97		250.07036			
425 Xpedition (4 x 4)	00		250.07036			
450 S Outlaw	08				250.07036	
450 Outlaw MXR	09-10				250.07036	
450 Sportsman	06-07		250.07036		250.07058	
455cc Diesel 4 x 4 EBS	99-01		250.07036			
500 ATP HO (4x4)	04-05		250.07036		250.07036	

BRAKE PADS/SHOES AND DISCS

Bearings

Braking

Bullbars

Cables

Carburettor

Driveline

Electrical

Exhausts

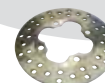

Polaris Cont.

Make & Model	Year	Left / Right	Front Brake Pad/Shoe	Brake Disc - Front	Rear Brake Pad/Shoe	Brake Disc - Rear
500 ATV Pro 4x4 PPS	02		250.07036		250.07058	
500 Big Boss 6 x 6	98-99		250.07036			
500 Big Boss 6 x 6 Middle Axle Brake	98-99		250.07036			
500 Magnum	99-01		250.07036			
500 Magnum (2 x 4/4 x 4 HDS)	02-03		250.07036		250.07058	
500 Outlaw	06-07		250.07036		250.07036	
500 Predator/TLD	03-07		250.07036		250.07036	
500 Scrambler 2x4	01-02		250.07036			
500 Scrambler 2x4	07-08		250.07036		250.07058	
500 Scrambler 4 x 4	97-04		250.07036			
500 Scrambler 4 x 4	05-12		250.07036		250.07058	
500 Sportsman 4 x 4	96-02		250.07036			
500 Sportsman/Worker 4 x 4	98-02		250.07036			
500 Sportsman HO/EFI	03-08		250.07036		250.07058	
500 Sportsman HO	09-12		250.07036			
500 Sportsman X2	06-08		250.07036		250.07058	
500 Sportsman 6 x 6	00-08		250.07036			
500 Sportsman X 2 EFI	07-09		250.07036		250.07036	
500 Sportsman Forest	12		250.07036		250.07058	
500 Sportsman Touring H.O.	08-11		250.07036		250.07036	
500 Sportsman Touring H.O.	11-12		250.07036		250.07075	
500 Sportsman EFI Quad H.O.	08-11		250.07036		250.07058	
500 Xplorer 4 x 4	97		250.07036			
525 S Outlaw	08-10				250.07036	
525 Outlaw IRS	08-11				250.07036	
550 Sportsman / XP / X2	09-12		250.07120		250.07120	
600 Sportsman 4x4	03-05		250.07036		250.07058	
700 Sportsman (4x4) / MV / X2	02-08		250.07036		250.07058	
800 Sportsman EFI / X2	05-09		250.07036		250.07058	
800 Sportsman EFI	10-12		250.07036			
800 Sportsman EFI Intl/HO	07-11		250.07036		250.07058	
800 Sportsman Forest	12		250.07120		250.07120	
800 Sportsman Touring/EFI	08-09		250.07036		250.07036	
800 Sportsman "Big Boss" / EFI 6x6 / EFI	09-12		250.07036		250.07058	

BRAKE PADS/SHOES AND DISCS

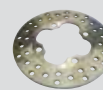
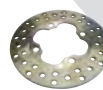

Polaris Cont.

Make & Model	Year	Left / Right	Front Brake Pad/Shoe	Brake Disc - Front	Rear Brake Pad/Shoe	Brake Disc - Rear
850 Sportsman Touring EPS	10-12		250.07120		250.07120	
850 Sportsman Forest	12		250.07120		250.07120	
850 XP Sportsman	09-12		250.07120		250.07120	
850 XP EPS Sportsman	09-12		250.07120		250.07120	

Polaris Side x Side Models

Make & Model	Year	Left / Right	Front Brake Pad/Shoe	Brake Disc - Front	Rear Brake Pad/Shoe	Hand Brake Pads
PPS/PTV 4x4/Series 10			250.07036		250.07058	
PPS/PTV 6x6/Series 10			250.07036			
PPS/UTV 2x4 / 4x6 Series 10			250.07075		250.07075	
1500 PPS/UTV 2x4 Series 11			250.07075		250.07075	
PPS LUH 6x6	02		250.07036			
PPS/Series 11 2x4/4x4/6x6			250.07075		250.07075	
Ranger Series 10 / 11			250.07075		250.07075	
Ranger 2x4/4x4	04-05		250.07075		250.07075	250.P1011
Ranger 6x6	04-05		250.07075		250.07075	250.P1011
Ranger TM	04-06		250.07075		250.07075	
Ranger XP	05		250.07075		250.07075	250.P1011
500 Ranger Series 10 6x6			250.07075		250.07075	
Ranger (Note: Middle brake N/A)	99		250.07036			
Note # For 6x6 model 4 rear discs required						
400 Ranger HO	10-11		250.09999		250.07075	
500 Ranger (2x4/4x4)	06-07		250.07075		250.07075	250.P1011
500 Ranger (4x4 EFI)	08-10		250.09999		250.07075	250.P1011
500 Ranger (4x4 EFI)	11-12		250.07075		250.07075	
500 Ranger (Carb) 2x4	08-09		250.09999		250.07075	250.P1011
500 Ranger (EFI) 4x4 H.O.	09-11		250.09999		250.07075	250.P1011
500 Ranger Crew	11-12		250.09999		250.07075	250.P1011
550 Sportsman X2	10		250.07120		250.07120	
700 Ranger 6x6 EFI	06-09		250.07075		250.07075	250.P1011
700 Ranger XP 4x4	06		250.07075		250.07075	250.P1011
700 Ranger 4x4 EFI/LE	07		250.07075		250.07075	250.P1011
700 Ranger 4x4 EFI	09		250.09999		250.07075	250.P1011
700 Ranger Crew (EFI) 4x4	09		250.09999		250.09999	250.P1011
700 Ranger 6x4 EFI	08		250.09999		250.07075	250.P1011



BRAKE PADS/SHOES AND DISCS

Bearings

Braking

Bullbars

Cables

Carburettor

Driveline

Electrical

Exhausts



Polaris Side x Side Models Cont.

Make & Model	Year	Left / Right	Front Brake Pad/Shoe	Brake Disc - Front	Rear Brake Pad/Shoe	Hand Brake Pad
700 Ranger XP 4x4	08		250.09999		250.07075	250.P1011
800 Ranger RZR	08-12				250.07036	
800 Ranger RZR S EFI	09-12				250.07036	
800 Ranger RZR-4	10-12		250.09999		250.07075	
Ranger EV (Electric)	10-11		250.09999		250.07075	250.P1011
800 Ranger HD / XP / 6X6	10-11		250.09999		250.07075	250.P1011
800 Ranger Crew	10-12		250.09999		250.09999	250.P1011
900 D Ranger 4X4 Diesel	11		250.09999		250.07075	250.P1011
900 Ranger RZR XP	11-12		250.09999		250.07075	



Quadzilla

Make & Model	Year	Left / Right	Front Brake Pad/Shoe	Brake Disc - Front	Rear Brake Pad/Shoe	Brake Disc - Rear
Ram R170	03-05		250.MBS2206		250.S3031	
Ram R170 E Stinger	03-05		250.MBS2206		250.S3031	
Stinger R170E	06		250.MBS2206		250.S3031	
4 Cross 200 E SUV	06-07				250.K5020	
4 Cross 200cc					250.Y2032	
ST 200 E (Automatic)	06-07		250.MBS2206		250.S3031	
ST 200 E (5 speed manual)	06-07				250.K5020	
250 e	06-11		250.K5020		250.K5020	
QZ 250 (Front disc model)			250.K5020		250.K5020	
Ram R250	03-05		250.MBS2206		250.S3031	
Stinger R250 E	06				250.K5020	
XRV 250					250.H1012	
QZ 270			250.K5020		250.K5020	
300 e XLC Stinger	07-11		250.K5020		250.K5020	
300 E XLC	06-07				250.K5020	
300 SE 4 Valve	06-07				250.K5020	
Jow 300	07-08		250.K5020		250.K5020	
QZ 300 XLC			250.K5020		250.K5020	
RL 300 Buggy	09-11		250.K5020		250.K5020	
XL 300					250.H1012	
320 CUV			250.K5020		250.K5020	
QZ 450 RS	06-09		250.K5020		250.K5020	
QZ 450 Sport	08-09		250.K5020		250.K5020	
CUV 500 Side X Side	10-11				250.Y2047	



BRAKE PADS/SHOES AND DISCS

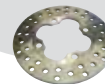

Quadzilla Cont.

Make & Model	Year	Left / Right	Front Brake Pad/Shoe	Brake Disc - Front	Rear Brake Pad/Shoe	Brake Disc - Rear
QZ 500 E/ES 4x4	09-11				250.Y2047	
RL 500 MK 11 Buggie	10-11				250.Y2047	
RS 5 4WD	10-11				250.Y2047	
XLC 500	10-11		250.K5020		250.K5020	
RS 6 4WD	10-11	Left	250.S3031			
	10-11	Right	250.Y2032			
RS 7 4WD	10-11		250.H1085		250.K5020	
X7 R	10-11		250.H1085		250.K5020	
RS 8	10-11		250.H1085		250.K5020	
Z 6 4X4	10-11				250.Y2047	

Suzuki

Make & Model	Year	Left / Right	Front Brake Pad/Shoe	Brake Disc - Front	Rear Brake Pad/Shoe	Brake Disc - Rear
LT-A 50 K Quadmaster	02-05		250.MBS3313			
LT-Z 50 K6/K7/K8/K9 Quadport	06-12		250.MBS3313			
LT 80 L/M/N/P/R/S/T/V/W/X/Y/K1-K6	87-06		250.MBS3313		250.MBS3315	
LT-Z 90 K7/K8/K9/L0 Quadport	07-12				250.MBS3315	
LT-F4WDX H-W	87-98		250.MBS3323			
LT 250 RH/RJ/RK/RL	87-90				250.S3036	
LT-F 250 J-K1	88-01		250.MBS3322		250.MBS3324	
LT-F 250 FX-FK2	99-02		250.MBS3322		250.MBS3324	
LT-F 250 K2-L2 Ozark	02-12		250.H1012		250.MBS3326	
LT-Z 250 K4-L0 Quadport	04-12		250.S3030		250.MBS3326	
LT-F4WD H-W	87-98		250.MBS3322		250.MBS3324	
LT-F 300 FX/FY/FK1	99-01		250.MBS3323			
LT-F 300 FK2	02	Left	250.Y2032	260.0205		
	02	Right	250.S3031	260.0205		
LT-F 4WD XH-W	87-98		250.MBS3323			
LT-A / LT-F 400 Eiger 4WD/2WD	02-07		250.H1012	260.0210	250.MBS3305	
LT-F / LT-A 400 King Quad Auto 4WD/2WD	08-13	Left	250.S3058	260.0210	250.MBS3307	
		Right	250.S3057	260.0210		
LT-Z 400 K3-L1	03-12		250.S3030		250.S3036	



BRAKE PADS/SHOES AND DISCS

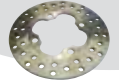

Suzuki Cont.

Make & Model	Year	Left / Right	Front Brake Pad/Shoe	Brake Disc – Front	Rear Brake Pad/Shoe	Brake Disc – Rear
LT-A 450 XK7-XK9	07-10	Left	250.S3058	260.0215		
		Right	250.S3057	260.0215		
LT-R 450 K6-L1	06-12	Left	250.Y2032		250.S3036	
		Right	250.S3031			
LT-A 500 FY/FK1	00-01	Left	250.Y2032			
		Right	250.S3031			
LT-A 500 FK2 Vision 4WD	02		250.H1012	260.0210	250.07064	
LT-A 500 FK3-FK7 Vinson 4WD Auto	03-07		250.H1012	260.0210		
LT-A 500 XPK9-XPL1 (Power Steering)	09-12	Left	250.S3058			
		Right	250.S3057			
LT-F 500 FW-FK2	98-02	Left	250.Y2032			
		Right	250.S3031			
LT-F 500 FK3-FK7 Vinson Quadrunner	03-07		250.H1012	260.0210		
LT-A 700 XK5-XK7 King Quad	05-07	Left	250.S3058	260.0215		
		Right	250.S3057	260.0215		
LT-V 700 FK4/FK5 Twin Peaks	04-05	Left	250.K5044	260.0115		
		Right	250.K5042	260.0115		
LT-A 750 XK8-XK	08-13	Left	250.S3058	260.0215		
		Right	250.S3057	260.0215		

SYM

Make & Model	Year	Left / Right	Front Brake Pad/Shoe	Brake Disc – Front	Rear Brake Pad/Shoe	Brake Disc – Rear
Trackrunner 200 Quad	05-09		250.H1085			
Quadlander 250	05-09		250.H1085			
Citymax 300 Quad	06		250.H1085			
Outlander 300	08-10		250.H1085		250.H1085	
Outlander 300 S	07-08		250.H1085		250.H1085	
Quadraider 600	06-07		250.H1012		250.H1085	
Quadraider 600	08-09		250.H1085		250.H1085	
Quadraider 600LE	10		250.H1085		250.H1085	

BRAKE PADS/SHOES AND DISCS

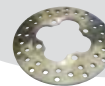

TGB

Make & Model	Year	Left / Right	Front Brake Pad/Shoe	Brake Disc – Front	Rear Brake Pad/Shoe	Brake Disc – Rear
250 Blade/Congo ATV	06-07		250.K5020			
Blade 325 Quad (4x2)	07-12				250.K5020	
Target 325 (4X2)	09-12				250.K5020	
Avenger 400 Quad (4x2)	07-10		250.H1085		250.H1085	
Target 400 (4X2)	09-10				250.K5020	
Blade (4x4) 425 Quad	07-10		250.H1085		250.H1085	
Target 425 (4X4)	09-11				250.K5020	
Blade 450 SE (4x4)	10-11		250.H1085		250.K5020	
Blade 460 R Target	12				250.K5020	
Blade 460 SL IRS 4x4	12		250.H1085		250.K5020	
Avenger 500 R Quad (4x2)	09-10		250.H1085		250.H1085	
Target 500 (4X2)	09-10				250.K5020	
Blade 510 LE	11-12		250.H1085		250.K5020	
Blade 525 SE 4X4	09-10		250.H1085		250.H1085	
Blade 525 SL 4X4	09-10		250.H1085		250.K5020	
525 SE 4X4	09		250.H1085		250.K5020	
Target 525 (4X4)	09-11				250.K5020	
Blade 550 LT 4X4	10-11		250.H1085		250.K5020	
Blade 550 SE 4X4	09-11		250.H1085		250.K5020	
Blade 550 SL 4X4	09-10		250.H1085		250.K5020	
Gunner 550 4 X 4 Target	10-12		250.H1085		250.H1085	
Blade 550 IRS Target	11-12		250.H1085		250.K5020	
550 IRS Blade LT	10-12		250.H1085		250.K5020	

Yamaha

Make & Model	Year	Left / Right	Front Brake Pad/Shoe	Brake Disc – Front	Rear Brake Pad/Shoe	Brake Disc – Rear
YFM 50 S-RX Raptor	04-09		250.MBS2206		250.MBS2220	
YFM 80 D-N Badger	92-01		250.MBS2206		250.MBS2220	
YFM 80 WP-RX Raptor	02-08		250.MBS2206		250.MBS2220	
YFM 80 GT-GX Grizzly	05-08		250.MBS2206		250.MBS2220	
YFM 90 RZ/RA /RB Raptor (With Rear Parking Brake)	10-12				250.K5020	
YFA1W/A/B Breeze	89-91		250.MBS2206			
YFA1D-R Breeze	92-03		250.MBS2206		250.MBS2220	
YFM 125 S/GT-GB Grizzly	04-12		250.MBS2206		250.MBS2220	
YFM 200 DXW/DX/DXA	89-90		250.MBS2206		250.Y2011	
YFS 200 B-P Blaster	91-02		250.MBS2206			



Bearings

Braking

Bullbars

Cables

Carburettor

Driveline

Electrical

Exhausts

BRAKE PADS/SHOES AND DISCS

Bearings

Braking

Bullbars

Cables

Carburettor

Driveline

Electrical

Exhausts

Yamaha Cont.

Make & Model	Year	Left / Right	Front Brake Pad/Shoe	Brake Disc - Front	Rear Brake Pad/Shoe	Brake Disc - Rear
YFS 200 R/S/T/V Blaster	03-06		250.H1012		250.S3030	
YFM 225 DRN/S/T/U	85-89		250.MBS2206		250.Y2011	
YFB 250 D-K Timberwolf	92-98		250.MBS2206		250.MBS2222	
YFB 250 FWF-FWK Timberwolf	94-00		250.MBS2222		250.MBS2222	
YFM 250 W/A/B	90-92		250.MBS2222		250.Y2011	
YFM 250 XLC/XL/X Bear Tracker	99-00		250.MBS2222		250.MBS2222	
YFM 250 XN/XP/XR/XS Bear Tracker	01-04		250.H1012		250.MBS2222	
YFM 250 BT/BV Bruin	05-06		250.H1012		250.MBS2226	
YFM 250 BW/BX/BY Big Bear	07-10		250.H1012		250.MBS2226	
YFM 250 RX/RV Raptor	08-09	Left	250.Y2060		250.S3030	
	08-09	Right	250.Y2059			
YFU1W/YFU1-T (230cc)	89-90		250.MBS2222			
YFM 300 B Grizzly	12				250.K5020	
YFM 350 FWT/FWU Big Bear	87-88				250.Y2011	
YFM 350 FWW-FWG	89-95		250.MBS2219		250.Y2011	
YFM 350 FWH/FWJ/FWK Big Bear	96-98		250.MBS2219			
YFM 350 XD-XS (Warrior)	92-04		250.H1012		250.S3030	
YFM 350 ERD	92		250.MBS2222		250.Y2011	
YFM 350 ERE/ERF/ERG	93-95		250.MBS2222		250.Y2011	
YFM 350 FXG-FXS Wolverine	95-04		250.H1012	260.0305	250.S3030	
YFM 350 UH/UJ/UK	96-98		250.MBS2219		250.MBS2222	
YFM 350 L Big Bear	99		250.H1012	260.0305		
YFM 350 FAS/FAT/FAV Bruin 4x4	04-06		250.H1012	260.0310	250.MBS2226	
YFM 350 ANS/ANT/ANV Bruin 2x4	04-06		250.H1012	260.0310	250.MBS2226	
YFM 350 S/T/V/RW-RV Raptor	04-09		250.S3030		250.S3030	
YFM 350 XV-XY 2WD - Wolverine	06-09		250.H1012	260.0310	250.MBS2226	
YFM 350 GW/GX/GY/GZ Grizzly -2WD	08-10		250.H1012	260.0310	250.MBS2226	
YFM 350 FGW-FGB Grizzly 4WD	07-12		250.H1012	260.0310	250.MBS2226	
YFM 350 FGIW-FGIZ Grizzly 4WD IRS	07-10		250.H1012	260.0310		
YFM 400 FEW-FWL Kodiak	93-99		250.MBS2219		250.MBS2217	
YFM 400 FAM/FAN	00-01		250.H1012	260.0305	250.Y2049	260.0320

BRAKE PADS/SHOES AND DISCS

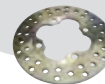















Yamaha Cont.

Make & Model	Year	Left / Right	Front Brake Pad/Shoe	Brake Disc - Front	Rear Brake Pad/Shoe	Brake Disc - Rear
YFM 400 FWP Big Bear 4x4	02		250.S3030	260.0305	250.MBS2217	
YFM 400 FPR/FPS Big Bear	03-04		250.H1012	260.0305	250.MBS2217	
YFM 400 FAR/FAS Kodiak Auto	03-04		250.H1012	260.0310	250.MBS2217	
YFM 400 AR Kodiak (5VH3/4)	03		250.H1012	260.0310	250.MBS2226	
YFM 400 FAT/FAV (Big Bear)	05-06		250.H1012	260.0310	250.Y2049	
YFM 400 FGW/FGX Grizzly	07-08		250.H1012		250.Y2049	
YFM 450 FAR/FAS Kodiak (5ND3/4)	03-04		250.H1012	260.0310	250.Y2049	260.0320
YFM 450 FAT/FAHT/FAV (Kodiak)	05-06		250.H1012	260.0310	250.Y2049	
YFM 450 FXV-FXZ Wolverine	06-10		250.H1012	260.0310	250.Y2049	260.0320
YFM 450 FGIZ/FGIA/FGIB Grizzly IRS	10-12		250.H1012	260.0310		
YFM 450 FGW Grizzly	07		250.H1012	260.0310	250.Y2049	
YFM 450 FGPA/FGPB Grizzly EPS	11-12		250.H1012	260.0310		
YFZ 450 S-X (Quad)	04-08	Left	250.Y2032		250.S3030	
	04-08	Right	250.S3031			
YFZ 450 RY/RZ (Quad)	09-10	Left	250.Y2032			
	09-10	Right	250.S3031			
YFM 550 FGPY/FGPZ/FGPA/FGPB Grizzly EPS	09-12	(Left)	250.Y2060		250.Y2062	
		(Right)	250.Y2059		250.Y2061	
YFM 600 FWAK/FWAL/FWAM/FWAN Grizzly	98-01		250.S3030		250.MBS2217	
YFM 600 HM Grizzly Hunting	00		250.S3030		250.MBS2217	
YFM 660 RN/RP/RR/RS/RT Raptor	01-05		250.S3030		250.S3030	
YFM 660 FR/FS/FT Grizzly	03-05		250.S3030		250.Y2047	
YFM 660 FWAP-FGX Grizzly	02-08		250.S3030		250.Y2047	
YXR 66 FAS/FAT/FAV Rhino 4x4 Side x Side	04-06	Left	250.S3031	260.0315		
	04-06	Right	250.Y2032	260.0315		
YFM 700 RV/RW/RX/RY - Raptor	06-09	Left	250.Y2032			
	06-09	Right	250.S3031			
YFM 700 FGPW/FGPX/FGPY/FGPZ/FGPA/FGPB Grizzly EPS	07-12	Left	250.Y2060		250.Y2062	
		Right	250.Y2059		250.Y2061	
YXR 700 Rhino 4x4 SE	09	Left	250.Y2032	260.0315	250.S3031	
YXR 700 Rhino 4x4 SE	09	Right	250.S3031	260.0315	250.S3031	

BRAKE PADS ID CHART















Brake Pad Sets

Pad	Dimensions mm	ATV City Part No.
	39.5 x 45 x 7.	250.H1012
	77.5 x 42.5 x 7.2	250.H1022
	75.35 x 39.35 x 11.7	250.H1084
	A: 94 x 46 x 8.5 B: 73 x 46 x 11	250.H1085
	81.8 x 38.45 x 10.1	R/H 250.H1090
	81.8 x 38.45 x 10.1	L/H 250.H1091
	97.8 x 42.4 x 7	250.HD6021
	A: 55.5 x 37 x 10 B: 85 x 43 x 8	250.K5020
	A: 26.1 x 119.55 x 7.1 B: 35.6 x 94.54 x 7.8	250.K5042
	A: 26.1 x 119.55 x 7.1 B: 35.6 x 94.54 x 7.8	250.K5044
	97 x 40 x 7	250.07036
	35 x 49 x 7	250.07044
	54.05 x 50.9 x 7.9	250.07053
	90.3 x 41.05 x 8.2	250.07058
	A: 82 x 41 x 9.5 B: 62 x 41 x 9.5	250.07064

BRAKE PADS ID CHART







Brake Pad Sets Cont.

Pad	Dimensions mm	ATV City Part No.
	95.4 x 39.55 x 6.85	250.07072
	97 x 51.7 x 6.95	250.07075
	95 x 48 x 7	250.07088
	96.88 x 42.45 x 6.87	250.07120
	A : 109.15 x 39.2 x 7.65mm B : 96.3 x 36.5 x 7.6mm	250.07400
	A : 109.15 x 39.2 x 7.65mm B : 96.3 x 36.5 x 7.6mm	250.07450
	120.65 x 57.35 x 6.9	250.09999
	Oem Ref 2203147	250.P1011
	46 x 45 x 7.8	250.S3030
	A: 96.7 x 42.7 x 7.4 B: 77 x 42.2 x 7.4	250.S3031
	47 x 45.1 x 7.5	250.S3036
	A: 82 x 40.85 x 8.2 B: 62 x 40.8 x 8.6	R/H 250.S3057
	A: 82 x 40.85 x 8.2 B: 62 x 40.8 x 8.6	L/H 250.S3058





BRAKE PADS ID CHART



	47 x 16.2	250.Y2011
	A: 96.7 x 42 x 7.4 B: 77.3 x 42 x 7.4	250.Y2032
	65.5 x 44.75 x 11.65	250.Y2047
	A: 82.08 x 40.85 x 9.46 B: 62.03 x 40.8 x 9.46	250.Y2049



Brake Pad Sets Cont.

Pad	Dimensions mm	ATV City Part No.
	A: 107 x 33.75 x 8 B: 91.66 x 38.2 x 8	250.Y2059
	A: 107 x 33.75 x 8 B: 91.66 x 38.2 x 8	250.Y2060
	A: 107 x 33.75 x 9 B: 91.66 x 38.2 x 9	250.Y2061
	A: 107 x 33.75 x 9 B: 91.66 x 38.2 x 9	250.Y2062

BRAKE DRUM SEALS



Honda

Front Brake Seal ATV City Part No.	Rear Brake Seal ATV City Part No.	Model
	530.6701	ATC250ES, ATC250SX 1985-87
	530.6701	TRX250 Fourtrax 1985-87
	530.7601	TRX90 1993 - 13
530.15901	530.7601	TRX300 2wd Fourtrax 300 1988 - 00
530.20301	530.7601	TRX300FW Fourtrax 4x4 1988 - 00
	530.6701	TRX350D 1987
530.20301	530.6701	TRX350D 1988 - 89
530.22001	530.7602	TRX350FE/TM Fourtrax Ranger 2000 - 06
530.22001	530.7602	TRX400FA, TRX400FGA Fourtrax Rancher 4X4 2004 - 07
530.20301	530.7602	TRX400FW Fourtrax Foreman 4X4 1995 - 01
530.20301	530.7602	TRX450ES, TRX450S 1998 - 01
530.22001	530.7602	TRX450FE, TRX450FM 2002 - 04
530.22001	530.7602	TRX500FA Rubicon 2001 - 04
	530.7602	TRX500FA, TRX500FM/TM 2005 - 11
530.22001		TRX650 Rincon 2003 - 05

Kawasaki

Front Brake Seal ATV City Part No.	Rear Brake Seal ATV City Part No.	Model
	530.20001	KLF220 Bayou 1988 - 02
	530.20001	KLF250 Bayou 2003-07
	530.20001	KLF300A /B Bayou 1986 - 07 92049-1242
	530.22501	KLF300C/400 Bayou 1993 - 99 92049-1312
530.8000	530.8000	Mule 2510/3020/4010 OEM 92093-1543

BRAKE DRUM SEALS



Suzuki

Front Brake Seal ATV City Part No.	Rear Brake Seal ATV City Part No.	Model
	530.20401	LT-4WD 1987-88
530.19201	530.20401	LT-4WD 1989 - 98
530.19201	530.20401	LT-F250 1988 - 01
530.19201	530.20401	LT-F4WD 1997 - 98
	530.13001	LT-F4WDX King Quad 1991 - 94
530.20801	530.13001	LT-F4WDX King Quad / LTF300F 1995 - 02
	530.15801	LT-A/LT-F400 Eiger 2002-07
	530.13001	LT-F / LT-A 400 4wd King Quad 2008 - 12
	530.13001	LT-F / LT-A 500F Quad Runner 1998 - 02

Yamaha

Front Brake Seal ATV City Part No.	Rear Brake Seal ATV City Part No.	Model
	530.19401	YFB250 Timberwolf 1992 - 94
530.19401	530.19401	YFB250FW Timberwolf 2wd/4wd 1994 - 00
530.19401	530.19401	YFM250 Beartracker 1999-04
530.19401		YFM250 Moto-4 1989 - 91
530.19401		YFM350ER Moto-4 1990 - 95
530.19401		YFM350FW Big Bear 1989 - 95
530.19401	530.19401	YFM350FW Big Bear 1996 - 98
	530.19401	YFM350FW Big Bear 1999
530.19401	530.19401	YFM350U Big Bear 1996 - 98
	530.19401	YFM350U Big Bear 1999
530.19401	530.19401	YFM400 Kodiak (4WD) 1993 - 98
	530.19401	YFM400 Kodiak (4WD) 1999
	530.19401	YFM600 Grizzly 1998-01

BRAKE CALIPERS



Brake Calipers and Pins

ATV City Part No.	Model
255.0005	Yamaha YFM 400/450 00-09 Suzuki Eiger LTF/LTA 400 02-08 LH
255.0010	Yamaha YFM 400/450 00-09 Suzuki Eiger LTF/LTA 400 02-08 RH

These Aftermarket Front brake calipers meet or exceed OEM specifications. All callipers come loaded with semi-metallic brake pads.

Brackets may need to be changed to fit your application.

SOLD EACH.

LEFT FRONT CALIPER...255.0005

RIGHT FRONT CALIPER...255.0010

Arctic Cat

04-08 DVX400

Honda

All TRX250X

01-Up TRX 250EX

All TRX300EX

All TRX400EX

07 - Up Trx 420 Rancher

Kawasaki

03 - 06 KXF400 KSF

99 - 02 KVF300 Prairie

03 - Up KVF360 Prairie

97 - 02 KVF400 Prairie

Suzuki

03-09 LTZ400 QuadSport

04-Up LTZ250 QuadSport

02 Up LT - A500F Vinson

02 Up LT - F/A400 Eiger

02 Up LT - F250 Ozark

Yamaha

01 - 05 YFM660R Raptor

03 - Up YFS200 Blaster

01 - Up YFM250 Bear Tracker

All YFM250 Bruin/Big Bear/Grizzly 250's

90 - Up YZF350 Banshee

04 - Up YFM350R Raptor

95 - Up YFM350FX Wolverine

89 - Up YFM350X Warrior

ALL YFM350 Grizzly

99 YFM350 Big Bear

00 - Up YFM400 Big Bear/Grizzly/Kodiak

03 - Up YFM450 Kodiak/Wolverine/Grizzly

98 - Up YFM600/660 Grizzly

Can be adapted to fit other models

Brake Calipers and Pins Cont.

ATV City Part No.	Model
255.0015	Kawasaki KLF 300/400 LH (Sorry - no right hand available currently)
255.0200	Brake pad locating pins to suit 255.0015
255.0205	Brake pad locating pins to suit 255.0005/0010



MASTER CYLINDER REBUILD KITS



HONDA - FRONT

Part No.	Application	
255.06001	ATC200X	(86-87)
	TRX200	(84)
	TRX200/D	(90-97)
	TRX200SX	(86-88)
	ATC250R	(85-86)
	TRX250	(85-86)
	TRX250	(97-08)
	TRX250EX	(01-08)
	TRX300	(88-99)
	TRX300EX	(05-08)
	ATC250X	(85-86)
	TRX350/D	(86-87)
	TRX350/4X4	(00-03)
	TRX400EX	(99-08)
255.06003	TRX300	(00)
	TRX300FW	(88-00)
	TRX400FW	(95-03)
	TRX450	(98-04)
	TRX500	(01-03)
	TRX500FA/FGA	(04)
255.06005	TRX350	(04-06)
	TRX400	(04-07)
	TRX420	(07-08)
	TRX500	(05-08)
	TRX500FA/FGA	(05-08)
	TRX650	(03-05)
	TRX680	(06-07)

HONDA - REAR

Part No.	Application	
255.06053	TRX650	(03-05)
	TRX680	(06-08)

KAWASAKI - FRONT

Part No.	Application	
255.06101	KSF250	(88-04)
	KEF300	(95-03)
	KLF300 / 4X4	(86-04)
	KVF300 / 4X4	(99-02)
	KVF360	(03-09)
	KLF400	(93-99)
	KVF400/4X4	(97-02)

KAWASAKI - FRONT CONT.

Part No.	Application	
255.06101	KVF650	(02-03)
	KVF650D/E	(05-09)
	KSV700	(04-09)
	KVF700	(04-06)
255.06102	KVF650F/H	(07-09)
	KVF750	(05-09)
	TRX400EX	(99-08)

SUZUKI - FRONT

Part No.	Application		
255.06201	LT230E/GE	(85-93)	
	LT230S	(85-88)	
	LTF230	(86-87)	
	LT250R	(85-92)	
	LTF250S	(89-90)	
	LTZ250	(04-08)	
	LT4WD	(87)	
	LT300E	(87-89)	
	LTZ400/Z	(03-08)	
	LTR450/Z	(06-08)	
	LT500R	(87-90)	
	255.06202	LT250EF	(85-86)
		LTF250/F	(88-08)
		LT4WD	(88-96)
LTF4WD		(97-98)	
LTF4WDX		(91-98)	
LTF300F		(99-02)	
LTA400/F		(02-08)	
LTF400/F		(02-08)	
LTA450X		(07-08)	
LTA500F		(00-07)	
LTF500F	(98-07)		
LTA700X	(05-07)		
LTA750X	(08)		

SUZUKI - REAR

Part No.	Application	
255.06252	LTR450/Z	(06-08)
	LTA500F	(06-07)
	LTF500F	(03-07)

YAMAHA - FRONT

Part No.	Application	
255.06303	YFS200	(03-06)
	YFM350R	(04-08)
	YFM350X	(02-04)
	YFZ350	(02-06)
	YFZ450	(04-06)
	YFM660R	(01-05)
	YFM700R	(06)
255.06304	YFM700FG	(07)
	YFM250B	(05-08)
	YFM250X	(02-04)
	YFM350A/G	(04-08)
	YFM350FA/FG	(04-08)
	YFM350FX	(02-05)
	YFM350X	(06-08)
	YFM400A	(03-04)
	YFM400F	(02-08)
	YFM400FA	(02-06)
YFM450FA/FG	(03-08)	
255.06301	YFM450FX	(06-08)
	YFM660F	(02-08)
	YFM350FW	(87-98)
	YFM350FX	(96-01)
	YFM350U	(96-98)
	YFM350X	(88-01)
	YFZ350	(87-01)
	Big Bear 400	(00-01)
	YFM400FW	(93-98)



Bearings

Braking

Bullbars

Cables

Carburettor

Driveline

Electrical

Exhausts

BRAKE CALIPER REBUILD KITS



Honda

Model	Year	Frnt / Rear	Hanger Pins	Seal Et Pin Kits	Brake Caliper Pistons
ATC200X	83-87	Front	255.08051	255.08501	255.08951
		Rear		255.08551	255.08971
ATC250R	81-84	Front	255.08051		255.08951
	82-84	Rear		255.08551	255.08971
	85-86	Rear		255.08552	
ATC350X	85-86	Rear		255.08551	255.08971
		Front			255.08952
TRX250EX	01-08	Front	255.08051	255.08501	255.08951
TRX250X	87-88	Front	255.08051	255.08501	
		Rear		255.08551	255.08971
TRX250X	91-92	Front	255.08051	255.08501	
		Rear		255.08551	255.08971
TRX250X	2009	Front	255.08051	255.08501	255.08951
TRX300EX	93-08	Front	255.08051	255.08501	255.08951
		Rear		255.08551	255.08971
TRX400EX	99-08	Front	255.08051	255.08501	255.08951
		Rear		255.08551	255.08971
TRX420	07-13	Front	255.08051	255.08503	255.08953
TRX450ER	07-12	Front		255.08504	
		Rear		255.08553	
TRX450R	04-09	Front		255.08504	255.08954
		Rear		255.08553	255.08972
TRX500 Foreman	05-11	Front		255.08505	255.08955
TRX500 Rubicon	05-12	Front		255.08505	255.08955
TRX650 FA	03-05	Rear		255.08554	
TRX680 Rincon	06-12	Front		255.08505	255.08955
		Rear		255.08554	
TRX700XX	08-09	Front		255.08504	255.08954
		Rear		255.08553	255.08972



Brake Pad Hanger Pins – These include required quantities of Brake pad hanger pins.



Brake Caliper Rebuild Kits – Each kit includes all necessary rubber components and pad hanger pins if it's applicable.



Brake caliper pistons – Pistons for replacing brake caliper. Includes required quantities.

BRAKE CALIPER REBUILD KITS



Kawasaki

Model	Year	Frt / Rear	Hanger Pins	Seal Et Pin Kits	Brake Caliper Pistons
KVF300/4x4	99-02	Front	255.08053	255.08602	255.08958
KVF360/4x4	03-12	Front	255.08053	255.08602	255.08958
KLF400	93-99	Front	255.08051	255.08601	255.08952
KVF400/4x4	97-02	Front	255.08053	255.08602	255.08958
KVF650	06-09	Front	255.08051	255.08601	255.08952
KVF750	05-12	Front	255.08051	255.08601	255.08952
KRF750	08-09	Front		255.08601	

Suzuki

Model	Year	Frt / Rear	Hanger Pins	Seal Et Pin Kits	Brake Caliper Pistons
LTF250	02-09	Front	255.08051	255.08701	255.08956
LTZ250	04-09	Front	255.08051	255.08701	255.08956
LT-F300F	99-02	Front			255.08954
LTA/LTF400/F	02-07	Front	255.08051	255.08701	255.08956
LTA/LTF400/F	08-13	Front	255.08054	255.08702	255.08957
LTZ400/Z	03-09	Front	255.08051	255.08701	255.08956
LTA450X	07-08	Front	255.08054	255.08702	255.08957
LTR450	06-09	Front	255.08051	255.08703	255.08952
LTA500F	00-01	Front	255.08051	255.08703	255.08952
	02-07	Front	255.08051	255.08701	255.08956
LTF500F	02-03	Rear			255.08974
	98-02	Front	255.08051	255.08703	255.08952
LTA700X	03-07	Front	255.08051	255.08701	255.08956
	06-07	Front	255.08054	255.08702	255.08957
LTA750X	08-13	Front	255.08054	255.08702	255.08957



Brake Pad Hanger Pins – These include required quantities of Brake pad hanger pins.



Brake Caliper Rebuild Kits – Each kit includes all necessary rubber components and pad hanger pins if it's applicable.



Brake caliper pistons – Pistons for replacing brake caliper. Includes required quantities.

BRAKE CALIPER REBUILD KITS



Yamaha

Model	Year	Frnt / Rear	Hanger Pins	Seal Et Pin Kits	Brake Caliper Pistons
YFS200	04-06	Front	255.08051	255.08801	255.08956
		Rear		255.08851	255.08971
YFM250B	05-09	Front	255.08051	255.08801	255.08956
YFM250X	01-04	Front	255.08051	255.08801	255.08956
YFM250R	08-12	Front		255.08802	255.08957
	08-09	Rear		255.08852	255.08971
	10-12	Rear		255.08851	
YFM350 Bruin	04-06	Front	255.08051	255.08801	255.08956
YFM350F/U	1999	Front	255.08051	255.08801	255.08956
YFM350FG/G	07-12	Front	255.08051	255.08801	255.08956
YFM350FX	95-05	Front	255.08051	255.08801	255.08956
		Rear		255.08853	255.08971
YFM350R	04-12	Front	255.08051	255.08801	255.08956
	04-09	Rear		255.08852	255.08971
YFM350X	89-04	Front	255.08051	255.08801	255.08956
		Rear		255.08853	255.08971
YFM350X	06-09	Front	255.08051	255.08801	255.08956
YFZ350	90-06	Front	255.08051	255.08801	255.08956
	87-06	Rear		255.08853	255.08971
YFM400A	00-01	Rear	255.08055	255.08854	255.08974
YFM400/F	00-12	Front	255.08051	255.08801	255.08956
YFM400A/FA	99-06	Front	255.08051	255.08801	255.08956
YFM400FA	00-06	Rear	255.08055	255.08854	255.08974
YFM450FA	03-06	Front	255.08051	255.08801	255.08956
		Rear	255.08055	255.08854	255.08974
YFM450FG	07-12	Front	255.08051	255.08801	255.08956
	2007	Rear	255.08055	255.08854	250.08974
YFM450FX	06-10	Front	255.08051	255.08801	255.08956
	06-09	Rear	255.08055	255.08854	255.08974



Brake Pad Hanger Pins – These include required quantities of Brake pad hanger pins.



Brake Caliper Rebuild Kits – Each kit includes all necessary rubber components and pad hanger pins if it's applicable.



Brake caliper pistons – Pistons for replacing brake caliper. Includes required quantities.

BRAKE CALIPER REBUILD KITS



Bearings

Braking

Bullbars

Cables

Carburettor

Driveline

Electrical

Exhausts

Yamaha Cont.

Model	Year	Frnt / Rear	Hanger Pins	Seal Et Pin Kits	Brake Caliper Pistons
YFZ450	04-09	Front	255.08054	255.08803	
	04-05	Rear		255.08852	255.08971
	06-09	Rear		255.08859	255.08975
YFZ450R	09-12	Front		255.08803	
		Rear		255.08859	
YFZ450X	10-11	Front		255.08803	
		Rear		255.08859	
YFM550FG	09-12	Front		255.08802	255.08957
		Rear		255.08856	255.08976
YFM600	98-01	Front	255.08051	255.08805	255.08956
YFM660F	02-08	Front	255.08051	255.08805	255.08956
		Rear	255.08056	255.08857	255.08977
YFM660R	01-05	Front	255.08051	255.08801	
		Rear		255.08851	255.08971
YFM700R	06-12	Front	255.08054	255.08803	
		Rear	255.08055	255.08858	
YFM700R	06-09	Front			255.08954
	06-09	Rear			255.08978
YFM700FG	07-12	Front		255.08802	255.08957
		Rear		255.08856	255.08976



Brake Pad Hanger Pins – These include required quantities of Brake pad hanger pins.



Brake Caliper Rebuild Kits – Each kit includes all necessary rubber components and pad hanger pins if it's applicable.



Brake caliper pistons – Pistons for replacing brake caliper. Includes required quantities.

WHEEL CYLINDERS & REBUILD KITS



HONDA

ATV City Part Num	Model	Year
255.06501	TRX200D	90-06
	TRX250	97-12
	TRX300 2wd	88-98
255.06503	TRX300FW 4x4	88-00
	TRX350	00-03
	TRX400FW	95-98
255.06504	TRX350D	86-89
255.06505	TRX350	04-06
	TRX400FA	04-07
	TRX400FW	99-03
	TRX450S/ES	98-04
	TRX500FA	01-04
	TRX650FA	03-05

SUZUKI

ATV City Part Num	Model	Year
255.06541	LT 4WD	87-96
	LTF250	88-01
	LTF 4WD/X	91-98

YAMAHA

ATV City Part Num	Model	Year
255.06561	YFM350FW	87-98
	YFM350U	96-98

REPLACEMENT BRAKE CYLINDERS (FRONT)

Honda

ATV City Part Num	Model	Year	
255.06565 (OEM Ref 45350-HN5-N01)	TRX350	04-06	R/H Front (Stamped "R")
	TRX400FA	04-07	R/H Front (Stamped "R")
	TRX450	98-04	R/H Front (Stamped "R")
255.06570 (OEM Ref 45370-HN5-N01)	TRX350	04-06	L/H Front (Stamped "L")
	TRX400FA	04-07	L/H Front (Stamped "L")
	TRX450	98-04	L/H Front (Stamped "L")
255.06575 (OEM Ref 45310-HC5-006)	TRX300	88-00	R/H Front (Stamped "R")
	TRX350	00-03	R/H Front (Stamped "R")
255.06580 (OEM Ref 45330-HC5-006)	TRX300	88-00	L/H Front (Stamped "L")
	TRX350	00-03	L/H Front (Stamped "L")
255.06585 (OEM Ref 45310-HN2-006)	TRX350	04-06	R/H Rear (Stamped "R")
	TRX450	98-04	R/H Rear (Stamped "R")
	TRX500FA	01-04	R/H Rear (Stamped "R")
255.06590 (OEM Ref 45330-HN2-006)	TRX350	04-06	L/H Rear (Stamped "L")
	TRX450	98-04	L/H Rear (Stamped "L")
	TRX500FA	01-04	L/H Rear (Stamped "L")
255.06595 (OEM Ref 45350-HC5-971)	TRX300	88-00	R/H Rear (Stamped "R")
	TRX350	00-03	R/H Rear (Stamped "R")
	TRX400	96-00	R/H Rear (Stamped "R")
255.06600 (OEM Ref 45370-HC5-971)	TRX300	88-00	L/H Rear (Stamped "L")
	TRX350	00-03	L/H Rear (Stamped "L")
	TRX400	96-00	L/H Rear (Stamped "L")



BRAKE DRUMS & BACKING PLATES



Honda

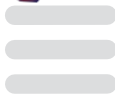

ATV City P/N	Description	Year	Oem Ref
245.0150	TRX300 Rear Brake Backing Plate	88-00	43010-HM5-A10
245.0155	TRX300 Rear Brake Drumv	88-00	42620-HC4-670
245.0005	TRX Front Brake Adjusting Bung		44602-HM5-A10

Kawasaki

ATV City P/N	Description	Year	Oem Ref
245.0200	KAF950 Mule 3010/4010 Front	00-12	41038-0034/1345/7501
	KAF620 Mule 3010/4010 Front	00-08	41038-0034/1345/7501
245.0210	KAF950 Mule 3010/4010 Rear	00-12	41038-0035
	KAF620 Mule 3010/4010 Rear	00-08	41038-0035

*Brake drum seals also available for P/N 245.0200 and 245.0210. Use seal number 530.8000

BRAKE CLEANERS AND LUBRICANTS



Brake Cleaner



ATV City P/N	Description
210.0040	CRC Brakleen 500ml (Aerosol) Brake parts cleaner. A powerful and fast drying cleaner. Cleans and degreases brakes and clutches. Removes oil, brake fluid, grease, street dirt and other hardened deposits. Leaves no residue. Fresh citrus smell.
210.0045	CRC Brakleen 5 Litre (Tin)

Brake Greases & Lubricants



ATV City P/N	Description
210.0230	CRC Braklube 100ml (Tube) A special metal-free lubricant for brake parts, can also be used for aluminium parts. Keeps critical parts free for optimum braking efficiency. Resists water and high temperature. Will not run off calipers and drum brake systems. Prevents corrosion. Do not use on rotors and friction side of brake pads.
210.0240	CRC Braklube 300ml (Aerosol)



210.0250	CRC Copper Paste 100ml (Tube) Effective anti-seize and mounting paste. High quality product based on a drop-free paste with very fine copper powder. Contains anti-corrosion additives, is water resistant and has separating properties up to 1100°C. Used as a paste on screws and bolts, as an effective anti-seize lubricant on connections or on brake pads to absorb disc brake noise.
210.0260	CRC Copper Paste 300ml (Aerosol)
210.0270	CRC Copper Paste 500g (Tin)



210.0345	CRC Disc Brake Quiet 100ml (Bottle) Paste that cures as a tough rubber. Prevents and stops disc brake noise and vibration.
----------	---



the best part of your atv

- 1: BEARINGS, BUSH KITS, BALLJOINTS
- 2: BRAKING
- 3: BULLBARS, MUDFLAP KITS
- 4: CABLES
- 5: CARBURETTOR PARTS
- 6: DRIVE LINE / CVT BELTS / AXLES
- 7: ELECTRICAL
- 8: EXHAUSTS
- 9: MISCELLANEOUS
- 10: FILTERS
- 11: SEAT COVERS, OVER COVERS
- 12: TOOLS
- 13: TYRES / TUBES / RIMS
- 14: ENGINE COMPONENTS
- 15: SPRAYERS & SPRAYER ACCESSORIES



3: BULLBARS, MUDFLAP KITS



BULLBARS



Honda

ATV City Part No.	Model
140.1128	TRX420 2007 - 13
140.1129	TRX500 FPMC 12 - 13

Suzuki

ATV City Part No.	Model
140.3125	LTA 400 FK8 2008
140.3128	LTF450 / 700 2007

Yamaha

ATV City Part No.	Model
140.2130	YFM400/450 Grizzly 2009 - 13
140.56408	YFM 700 Grizzly 2009

MUD FLAP KITS



Mud Flap Kit

ATV City Part No.	Model
145.0100	Universal Mud Flap Kit

THE ATV CITY FARM KIT



Bullbars , Dog Mat , Mudflaps and Towball

MV CITY[®]

the best part of your atv

- 1: BEARINGS, BUSH KITS, BALLJOINTS
- 2: BRAKING
- 3: BULLBARS, MUDFLAP KITS
- 4: CABLES
- 5: CARBURETTOR PARTS
- 6: DRIVE LINE / CVT BELTS / AXLES
- 7: ELECTRICAL
- 8: EXHAUSTS
- 9: MISCELLANEOUS
- 10: FILTERS
- 11: SEAT COVERS, OVER COVERS
- 12: TOOLS
- 13: TYRES / TUBES / RIMS
- 14: ENGINE COMPONENTS
- 15: SPRAYERS & SPRAYER ACCESSORIES

4: CABLES



CABLES



Honda

ATV City Part No.	Part	Model	Oem Ref Number
300.0050	Foot brake cable	TRX250 Recon / Fourtrax 97-13	43470-HM8-000
300.0055	Hand brake cable	TRX250 Recon / Fourtrax 97-13	43460-HM8-800
300.0100	Foot brake cable	TRX300 Big Red / Fourtrax 88-92	43470-HC4-000
300.0105	Hand brake cable	TRX300 Big Red / Fourtrax 88-92	43460-HC4-010
300.0110	Choke cable	TRX300 Big Red / Fourtrax 88-95	17950-HC4-671
300.0115	Foot brake cable	TRX300 Big Red / Fourtrax 93-00	43470-HM5-630
300.0120	Hand brake cable	TRX300 Big Red / Fourtrax 96-00	43460-HM5-A11
300.0125	Choke Cable	TRX300 Big Red / Fourtrax 96-00	17950-HM5-850
300.0215	Foot brake cable	TRX350 Rancher / Fourtrax 00-05	43470-HN5-670
300.0220	Hand brake cable	TRX350 00-05	43460-HN5-670
300.0225	Choke cable	TRX350 00-03	17950-HN5-671
300.0215	Foot brake cable	TRX400FA Rancher / Fourtrax 00-05	43470-HN5-670
300.0215	Foot brake cable	TRX400FW Foreman 95-00	43470-HM7-000
300.0220	Hand brake cable	TRX400FW Foreman 95-00	43460-HM7-000
300.0230	Foot Brake Cable	TRX420TE/FM Rancher / Fourtrax 07-13	43470-HP5-601
300.0235	Hand Brake Cable	TRX420TE/FM Rancher / Fourtrax 07-13	43460-HP5-601
300.0265	Hand Brake Cable	TRX420 FA/FE/TM Rancher 2014	43460-HR3-A21
300.0270	Foot Brake Cable	TRX420 FA/FE/FM Rancher 2014	43470-HR3-A21
300.0240	Foot Brake Cable	TRX450 Foreman 98-04	43470-HN0-A00
300.0245	Hand Brake Cable	TRX450 Foreman 98-04	43460-HN0-A00
300.0250	Foot brake cable	TRX500 Foreman 05-11	43470-HP0-A00
300.0255	Hand Brake Cable	TRX500 Foreman 05-13	43460-HP0-A00
300.0260	Foot Brake Cable	TRX500FE/FM Foreman 12-13	43470-HR0-F01
300.0265	Hand Brake Cable	TRX500 FE/FM Foreman 2014	43460-HR3-A21
300.0270	Foot Brake Cable	TRX500 FE/FM Foreman 2014	43470-HR3-A21

Bearings

Braking

Bullbars

Cables

Carburettor

Driveline

Electrical

Exhausts

CABLES



Kawasaki

ATV City Part No.	Part	Model	Oem Ref Number
300.1005	Hand brake cable	KLF220/250 Bayou	54005-1155
300.1100	Foot brake cable	KLF300B 2wd Bayou (L/H Only)	54005-1157
300.1105	Foot brake cable	KLF300C 4x4 Bayou	54005-1147
300.1110	Hand brake cable	KLF300C 4x4 Bayou	54005-1148
300.1250	Foot brake cable	KLF400 4x4 Bayou 93-99	54005-1169
300.1255	Hand brake cable	KLF400 4x4 Bayou 93-99	54005-1170
300.1300	Foot brake cable	KVF360 Prairie 03-12	54005-0019
300.1305	Hand brake cable	KVF360 Prairie 03-12	54005-0020
300.1300	Foot brake cable	KVF650 Prairie / Brute 02-13	54005-0019
300.1305	Hand brake cable	KVF650 Prairie / Brute 02-13	54005-0020
300.1305	Hand Brake Cable	KVF700 Prairie 04-13	54005-0020
300.1400	Hi-Lo Cable	Mule 3010 / 4010 07-13	54010-1124
300.1405	Forw/Rev Cable	Mule 3010 / 4010 07-13	54010-0006
300.1410	R/H Brake Cable	Mule 3010 / 4010 07-13	54005-1202/0025
300.1415	L/H Brake Cable	Mule 3010 / 4010 07-13	54005-1201/0023/0306

Suzuki

ATV City Part No.	Part	Model	Oem Ref Number
300.2005	Front brake cable	LT80 87-06	58110-40B00
300.2050	Hand Brake Cable	LTF250 Ozark 02-12	58810-05G11
300.2055	Foot Brake Cable	LTF250 Ozark 02-12	58510-05G00
300.2100	Hand brake cable	LTF250 Quad Runner/ 300 King Quad 88-02	58810-19B02
300.2105	Choke cable	LTF250/LTF300 87-02	58410-19B10
300.2150	Foot brake cable	LTF/LTA400 Eiger 02-07	58510-38F01
300.2155	2wd/4wd Shift Cable	LTF/LTA400 Eiger 02-07	58690-38F00
300.2160	Hand Brake Cable	LTF/LTA400 Eiger 02-07	58810-38F11
300.2150	Foot Brake Cable	LTF/LTA400 King Quad 08-13	58510-27H00
300.2160	Hand Brake Cable	LTF/LTA400 King Quad 08-13	58810-27H10
300.2155	2wd/4wd Shift Cable	LTF/LTA400 King Quad 08-13	58690-27H00
300.2200	Hand Brake Cable	LTA450/500/700/750 King Quad 05-13	58810-31G00
300.2205	Foot Brake Cable	LTA450/500/700/750 King Quad 05-13	58510-31G00

CABLES



Yamaha

ATV City Part No.	Part	Model	Oem Ref Number
300.3020	Upper Front Brake Cable	YFM125 Breeze / Grizzly 97-12	3FA-26373-00
300.3025	Lower Front Brake Cable	YFM125 Breeze / Grizzly 97-12	3FA-26361-10
300.3030	Rear Hand Brake Cable	YFM125 Breeze / Grizzly 97-12	3FA-26351-03
300.3100	Upper Front Brake Cable	YFB250 Timberwolf / Bear Tracker 92-00	4BD-26373-01-01
300.3105	Lower Front Brake Cable	YFB250 Timberwolf 92-00	4KD-26361-01-00

Yamaha cont.

ATV City Part No.	Part	Model	Oem Ref Number
300.3110	Rear hand brake cable	YFB250 Timberwolf 92-00	4KD-26341-01-00
300.3200	Rear hand brake cable	YFM350FW Big Bear 87-97	3HN-26341-00-00
300.3400	Hand Brake Cable	YFM350 Grizzly IRS 07-11	4S2-F6341-00
300.3450	Foot Brake Cable	YFM350 Grizzly IRS 07-11	4S2-26361-01
300.3300	Rear hand brake cable	YFM400FW Kodiak 93-98	4SH-26341-00-00
300.3400	Hand Brake Cable	YFM450 Grizzly IRS 08-10	4S2-F6341-00
300.3450	Foot Brake Cable	YFM450 Grizzly IRS 08-10	4S2-26361-01

Cable luber

ATV City Part No.	Description
285.0010	Fully lubricate cables in seconds





the best part of your atv

- 1: BEARINGS, BUSH KITS, BALLJOINTS
- 2: BRAKING
- 3: BULLBARS, MUDFLAP KITS
- 4: CABLES
- 5: CARBURETTOR PARTS
- 6: DRIVE LINE / CVT BELTS / AXLES
- 7: ELECTRICAL
- 8: EXHAUSTS
- 9: MISCELLANEOUS
- 10: FILTERS
- 11: SEAT COVERS, OVER COVERS
- 12: TOOLS
- 13: TYRES / TUBES / RIMS
- 14: ENGINE COMPONENTS
- 15: SPRAYERS & SPRAYER ACCESSORIES



5: CARBURETTOR PARTS

CARBURETTOR REPAIR KITS



"Japanese made complete kits to rebuild O.E carburettors. Each kit contains all necessary parts such as: Jet Needles, main and slow jets, float chamber gasket and float valves."

Honda

ATV City Part No.	Application	Year
165.03042	TRX250/ES	(97-02)
	TRX250EX	(01-05)
	TRX250TE/TM	(02-05)
165.03051	TRX250TE/TM	(06-09)
165.03021	TRX300/FW	(88-90)
165.03029	TRX300/FW	(91-92)
165.03031	TRX300/FW	(93-00)
165.03023	TRX350 / D	(86-88)
165.03039	TRX350	(00-03)
165.03053	TRX350	(04-06)
165.03045	TRX400FA/FGA	(04-07)
165.03037	TRX400FW	(95-03)
165.03040	TRX450ES/S	(98-03)
165.03048	TRX500 (475CC)	(05-09)
165.03043	TRX500FA/FGA	(01-04)
165.03055	TRX500FA/FGA	(05-09)
165.03046	TRX650FA/FGA	(03-05)

Yamaha

ATV City Part No.	Application	Year
165.03319	YFA-1	(89-04)
	YFM125	(04-06)
165.03306	YFB250/U	(92-98)
	YFB250FW	(94-98)
165.03302	YFM250	(89-91)
165.03316	YFM250	(99-04)
165.03324	YFM250B	(05-09)
165.03321	YFM350/4WD	(04-09)
165.03304	YFM350ER	(89-93)
	YFM350FW	(89-97)
	YFM400FW	(93-95)
165.03330	YFM350F	(98-99)
	YFM350U	(99)
165.03326	YFM350FX	(96-05)

CARBURETTOR REPAIR KITS



"Japanese made complete kits to rebuild O.E carburettors. Each kit contains all necessary parts such as: Jet Needles, main and slow jets, float chamber gasket and float valves."

Yamaha cont.

ATV City Part No.	Application	Year
165.03312	Big Bear 400	(00-12)
165.03311	Kodiak 400	(96-98)
165.03313	Kodiak 400	(00-04)
165.03317	YFM450	(03-06)
	YFM450FX	(06)
165.03332	YFM450FG	(07-12)
	YFM450FX	(07-10)
165.03314	YFM600	(98-01)
165.03318	YFM660	(02-05)
165.03333	YFM660F	(06-08)
165.03328	YXR660F Rhino	(04-07)

Suzuki

ATV City Part No.	Application	Year
165.03222	LTA50	(02-05)
165.03223	LTZ50	(06-09)
165.03210	LT80	(87-06)
165.03208	LT160	(89-00)
165.03211	LTF250	(97-99)
	LTF4WD	(97-98)
165.03214	LTF250 / F	(00-02)
165.03215	LTF250	(03-09)
165.03209	LT4WDX	(91-98)
	LTF300F	(99)
165.03220	LTF300F	(00-02)
165.03213	LTA / LTF400F	(03-07)
165.03224	LTA / LTF400F	(08-09)
165.03216	LTA / LTF500F	(02-07)

Kawasaki

ATV City Part No.	Application	Year
165.03222	KSF50	(03-06)

CARBURETTOR REPAIR KITS



"Japanese made complete kits to rebuild O.E carburettors. Each kit contains all necessary parts such as: Jet Needles, main and slow jets, float chamber gasket and float valves."

Kawasaki cont.

ATV City Part No.	Application	Year
165.03101	KLF220	(88-02)
165.03111	KLF250	(03-06)
165.03120	KLF250	(07-11)
165.03103	KLF300	(86-88)
165.03104	KLF300	(89-04)
165.03105	KLF300 4x4	(89-04)
165.03112	KVF360	(03-09)
165.03107	KLF400	(93-95)
165.03108	KLF400	(96-99)
165.03113	KVF650 *	(02-09)
	KVF700	(04-06)
165.03116	KSV700	(04-09)
165.03119	KVF750	(05-07)

Polaris

ATV City Part No.	Application	Year
165.03411	Phoenix 200	(05-09)
165.03409	Magnum 330	(03-05)
	Trail Boss 330	(03-05)
165.03412	Sportsman 400	(01-02)
165.03413	Sportsman 400	(03-05)
165.03414	Sportsman 450	(06-07)
	Sportsman 400 HO	(08-09)
165.03410	Sportsman 500	(03-05)
165.03416	Sportsman 500	(99-00)
165.03417	Sportsman 700	(02-06)

* Parts included for two carburetors

CARBURETTOR REPAIR KITS



CARBURETTOR CLEANER



Carburettor Cleaner

ATV City Part No.	OEM Part No.
210.0060	CRC Carburettor Cleaner 300ml Cleans the carburettor and fuel dispensing system. Dissolves gum and resin. Removes carbon deposits and varnish. CRC Carburettor Cleaner makes the Engine run smoother. Can be used on carburettors of cars, chain saws, lawn Mowers, alarm systems.

FLOAT VALVES



Honda

ATV City Part No.	OEM Part No.	Model
100.0070	16155-397, KJ9	TRX300-450

CARBURETTOR TOOL KITS



Carburettor Tool Kit

ATV City Part No.	OEM Part No.
285.0035	Right angled carb adjusting toolkit





the best part of your atv

- 1: BEARINGS, BUSH KITS, BALLJOINTS
- 2: BRAKING
- 3: BULLBARS, MUDFLAP KITS
- 4: CABLES
- 5: CARBURETTOR PARTS
- 6: DRIVE LINE / CVT BELTS / AXLES
- 7: ELECTRICAL
- 8: EXHAUSTS
- 9: MISCELLANEOUS
- 10: FILTERS
- 11: SEAT COVERS, OVER COVERS
- 12: TOOLS
- 13: TYRES / TUBES / RIMS
- 14: ENGINE COMPONENTS
- 15: SPRAYERS & SPRAYER ACCESSORIES



6: DRIVE LINE



UNIVERSAL JOINTS

Arctic Cat

Model	Year	Application	Figure	Location	ATV City Part No
250	2006-08	2X4	HH	1	600.ATV602
250	2001-05	4X4	BB	1	600.ATV600
300	1998-05	4X4	BB	1	600.ATV600
375	2002	4X4	BB	1	600.ATV601
400	2007-08	4X4	BB	1	600.ATV601
400	2005-06	4X4- Exc. Value Package	BB	1	600.ATV601
400	2005-06	4X4- Value Package	BB	1,3	600.ATV601
400	2003-04	4X4	BB	1	600.ATV601
400	1998-02	4X4	BB	1	600.ATV600
454	1996-98	4X4	BB	1	600.ATV600
500	2003-08	4X4	BB	1	600.ATV601
500	1998-02	4X4	BB	1	600.ATV600
650	2007-08	4X4 - Secondary Drive Shaft	BB	4	600.ATV601
650	2005-06	4X4 H1 - Secondary Drive Shaft	BB	4	600.ATV601
650	2005-06	4X4 V2 - Front Drive Shaft	BB	1,3	600.ATV601
650	2005-06	4X4 V2 - Rear Drive Shaft	BB	4,6	600.ATV603
650	2004	4X4 - Front Drive Shaft	BB	1,3	600.ATV601
650	2004	4X4 - Rear Drive Shaft	BB	4,6	600.ATV603
650 PROWLER XT	2007-08	4X4 - Rear Drive Shaft	MM	6	600.ATV603
650 PROWLER XT	2007-08	4X4 - Secondary Drive Shaft	MM	4	600.ATV603
650 PROWLER XT	2006	4X4 - Front Drive Shaft	MM	1	600.ATV601
650 PROWLER XT	2006	4X4 - Rear Drive Shaft	MM	6	600.ATV603
650 PROWLER XT	2006	4X4 - Secondary Drive Shaft	MM	3	600.ATV601
650 PROWLER XT	2006	4X4 - Secondary Drive Shaft	MM	4	600.ATV603
700	2007-08	4X4 - Front Drive Shaft	BB	1,3	600.ATV601

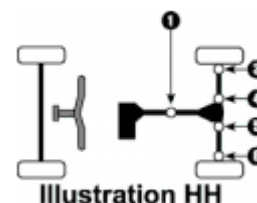
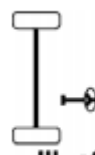
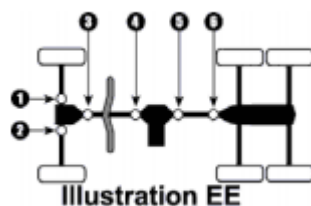
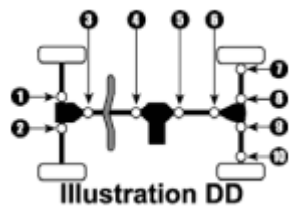
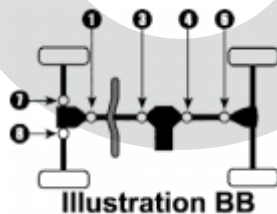
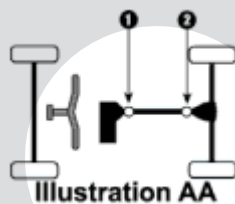

*See page 6-8 for Universal Joint Chart (ATV)



UNIVERSAL JOINTS

CAN-AM(Bombardier)

Model	Year	Application	Figure	Location	ATV City Part No
OUTLANDER 330	2004-05	2WD	AA	1,2	600.ATV505
OUTLANDER 330	2004-05	4WD	LL	4,6	600.ATV505
OUTLANDER 400	2006-07	4WD	LL	4,6	600.ATV505
OUTLANDER 400	2003-05	2WD	AA	1,2	600.ATV505
OUTLANDER 400	2003-05	4WD	LL	4,6	600.ATV505
OUTLANDER 500	2007	4WD	LL	3	600.ATV505
OUTLANDER 500	2007	4WD	LL	4,6	600.ATV800
OUTLANDER 650	2006-07	4WD	LL	3	600.ATV505
OUTLANDER 650	2006-07	4WD	LL	4,6	600.ATV800
OUTLANDER 800	2006-07	4WD	LL	3	600.ATV505
OUTLANDER 800	2006-07	4WD	LL	4,6	600.ATV800
QUEST 500	2004	4WD	LL	4	600.ATV505
QUEST 500	2002-03	4WD	LL	1,3,4	600.ATV505
QUEST 650	2004	4WD	LL	4	600.ATV800
QUEST 650	2002-03	4WD	LL	4	600.ATV800
QUEST 650	2002-03	4WD	LL	1,3	600.ATV505
RENEGADE 500	2008	4WD	LL	3	600.ATV505
RENEGADE 500	2008	4WD	LL	4,6	600.ATV800
RENEGADE 800	2007-08	4WD	LL	3	600.ATV505
RENEGADE 800	2007-08	4WD	LL	4,6	600.ATV800
TRAXTER	1999-04	4WD	LL	1,3,4	600.ATV505

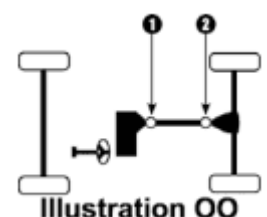
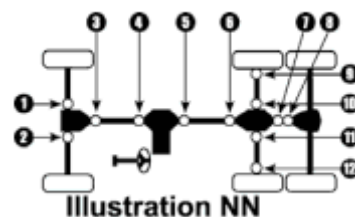
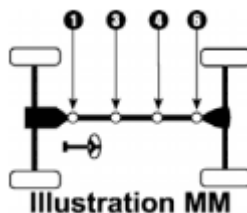
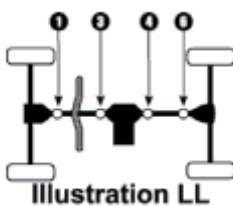
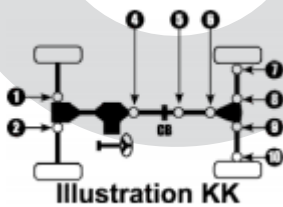
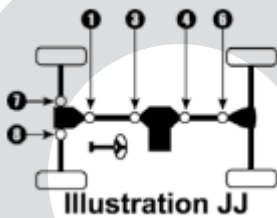

*See page 6-8 for Universal Joint Chart (ATV)



UNIVERSAL JOINTS

JOHN DEERE

Model	Year	Application	Figure	Location	ATV City Part No
GATOR HPX	2005-07	4X4- Front Axles	JJ	7,8	600.ATV500

Kawasaki

Model	Year	Application	Figure	Location	ATV City Part No
BAYOU 300	1989-04	4WD- Front Prop Shaft	LL	1,3	600.ATV700
BAYOU 400	1993-99	4WD- Front Prop Shaft	LL	1,3	600.ATV701
BRUTE FORCE 650	2005-13	4WD	LL	4	600.ATV703
BRUTE FORCE 650i	2006-13	4WD	DD	5,6	600.ATV703
BRUTE FORCE 750i	2005-11	4WD	DD	5,6	600.ATV703
KFX 700	2004-09	2WD	AA	2	600.ATV703
MULE 1000	1988	2WD- 450cc	KK	7,10	600.ATV702
MULE 2500	1994-00	2WD- 620cc	KK	7,8,9,10	600.ATV704
MULE 2510	2000-02	4WD- 620cc & 950cc Diesel- Prop Shaft	KK	4,5,6	600.ATV702
MULE 2510	2000-02	4WD- 620cc & 950cc Diesel- Rear Axles	KK	7,8,9,10	600.ATV704
MULE 2510	1993-99	4WD- 620cc- Front Axles	KK	1,2	600.ATV704
MULE 2510	1993-99	4WD- 620cc- Prop Shaft	KK	4,5,6	600.ATV700
MULE 2510	1993-99	4WD- 620cc- Rear Axles	KK	7,8,9,10	600.ATV704
MULE 2520	1993-00	2WD- 620cc	FF	1,2,3,4	600.ATV704
MULE 3000	2001-08	2WD- 620cc	FF	1,2,3,4	600.ATV704
MULE 3010	2001-08	4WD- 620cc & 950cc Diesel- Prop Shaft	KK	4,5,6	600.ATV702
MULE 3010	2001-08	4WD- 620cc & 950cc Diesel- Rear Axles	KK	7,8,9,10	600.ATV704
MULE 3020	2001-03	2WD- 620cc	FF	1,2,3,4	600.ATV704
MULE 4000	2009-12	2WD- 620cc	FF	1,2,3,4	600.ATV704
MULE 4010	2009-12	4WD- 620cc & 950cc Diesel- Prop Shaft	KK	4,5,6	600.ATV702
MULE 4010	2009-12	4WD- 620cc & 950cc Diesel- Rear Axles	KK	7,8,9,10	600.ATV704

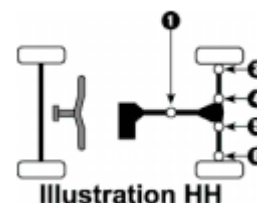
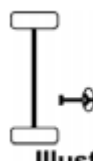
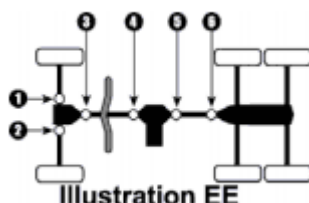
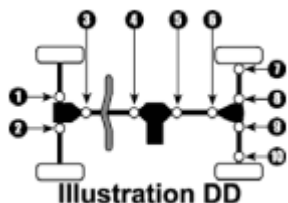
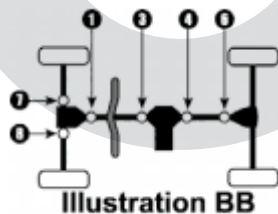
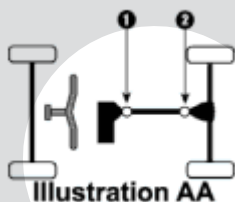

*See page 6-8 for Universal Joint Chart (ATV)



UNIVERSAL JOINTS

Kawasaki(Continued)

Model	Year	Application	Figure	Location	ATV City Part No
MULE 610	2005-12	4WD- 400cc- Front Prop Shaft	DD	3,4	600.ATV702
MULE 610	2005-12	4WD- 400cc- Rear Prop Shaft	DD	5,6	600.ATV702
PRAIRIE 300	1999-02	2WD	AA	2	600.ATV702
PRAIRIE 300	1999-02	4WD- Front Prop Shaft	LL	1,3	600.ATV701
PRAIRIE 300	1999-02	4WD- Rear Prop Shaft	LL	4	600.ATV702
PRAIRIE 360	2010-13	4WD	LL	4	600.ATV703
PRAIRIE 360	2003-09	2WD	AA	2	600.ATV703
PRAIRIE 360	2003-09	4WD	LL	4	600.ATV703
PRAIRIE 400	1999-02	2WD	AA	2	600.ATV702
PRAIRIE 400	1999-02	4WD- Front Prop Shaft	LL	1,3	600.ATV701
PRAIRIE 400	1999-02	4WD- Rear Prop Shaft	LL	4	600.ATV702
PRAIRIE 400	1998	2WD	AA	2	600.ATV702
PRAIRIE 400	1998	4WD- Front Prop Shaft	LL	1,3	600.ATV701
PRAIRIE 400	1998	4WD- Rear Prop Shaft	LL	4	600.ATV701
PRAIRIE 400	1997	4WD- Front Prop Shaft	LL	1,3	600.ATV701
PRAIRIE 400	1997	4WD- Rear Prop Shaft	LL	4	600.ATV701
PRAIRIE 650	2002-03	4WD	LL	4	600.ATV703
PRAIRIE 700	2004-06	4WD	LL	4	600.ATV703
TERYX 750	2012	4WD - Exc. Teryx4 - Front Prop Shaft	LL	1,3	600.ATV702
TERYX 750	2012	4WD - Exc. Teryx4 - Rear Prop Shaft	LL	4,6	600.ATV704
TERYX 750	2008-11	4WD - Front Prop Shaft	LL	1,3	600.ATV702
TERYX 750	2008-11	4WD - Rear Prop Shaft	LL	4,6	600.ATV704

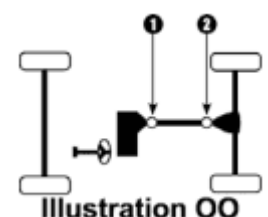
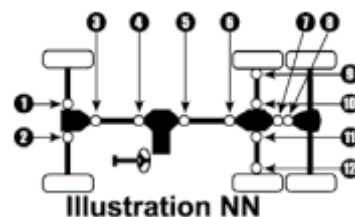
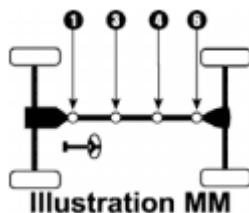
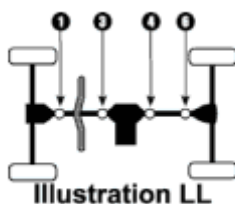
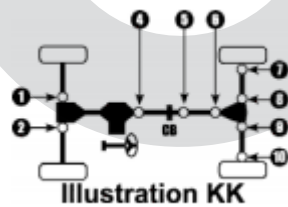
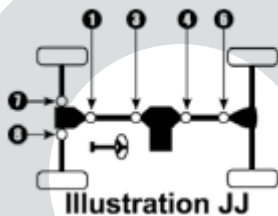

*See page 6-8 for Universal Joint Chart (ATV)



UNIVERSAL JOINTS

Kubota

Model	Year	Application	Figure	Location	ATV City Part No
RTV900	2003-08	4WD- Rear Axles	DD	7,8,9,10	600.ATV900

Polaris

Model	Year	Application	Figure	Location	ATV City Part No
250	1993	6X6	EE	1,2	600.ATV500
250	1990	4X4	BB	7,8	600.ATV500
300	1996	4X4	BB	7,8	600.ATV500
300	1995	4X4	BB	7,8	600.ATV501
300	1994	4X4	BB	7,8	600.ATV500
300	1994	6X6	EE	1,2	600.ATV500
400	1995	6X6 - W/ Inside Lock Rings	EE	1,2	600.ATV500
400	1995	6X6 - W/ Outside Lock Rings	EE	1,2	600.ATV501
400	1994	4X4	BB	7,8	600.ATV500
400	1994	6X6	EE	1,2	600.ATV500
350L	1993	4X4	BB	7,8	600.ATV500
350L	1993	6X6	EE	1,2	600.ATV500
350L	1990	4X4	BB	7,8	600.ATV500
ATP 330	2005	4X4 - Front Prop Shaft	BB	1,3	600.ATV500
ATP 330	2005	4X4 - Rear Prop Shaft	BB	4	600.ATV501
ATP 330	2004	4X4 - Front Axles	BB	7,8	600.ATV500
ATP 330	2004	4X4 - Front Prop Shaft	BB	1,3	600.ATV500
ATP 330	2004	4X4 - Rear Prop Shaft	BB	4	600.ATV501
500 H.O.	2005	4X4 - Front Prop Shaft	BB	1,3	600.ATV500
500 H.O.	2005	4X4 - Rear Prop Shaft	BB	4	600.ATV501
500 H.O.	2004	4X4 - Front Axles	BB	7,8	600.ATV500
500 H.O.	2004	4X4 - Front Prop Shaft	BB	1,3	600.ATV500
500 H.O.	2004	4X4 - Rear Prop Shaft	BB	4	600.ATV501
Pro 500	2002	4X4 - Front Prop Shaft	BB	1,3	600.ATV500
Pro 500	2002	4X4 - Rear Prop Shaft	BB	4	600.ATV500
BIG BOSS 250	1991-92	6X6	EE	1,2	600.ATV500

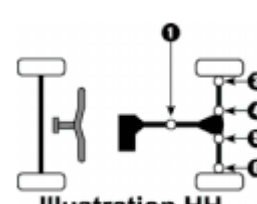
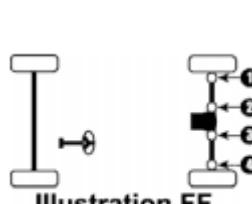
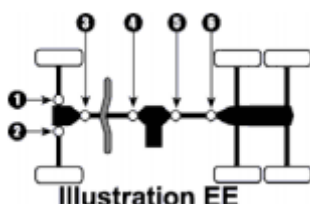
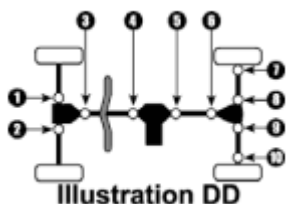
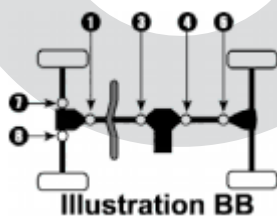
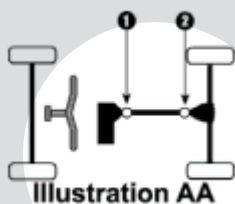

*See page 6-8 for Universal Joint Chart (ATV)

UNIVERSAL JOINTS



Polaris (Continued)

Model	Year	Application	Figure	Location	ATV City Part No
BIG BOSS 400L	1997	6X6	EE	1,2	600.ATV501
BIG BOSS 500	1998-99	6X6	EE	1,2	600.ATV501
DIESEL 455	2001	4X4 - Front Axles- W/ Inside Lock Rings	DD	1,2	600.ATV500
DIESEL 455	2001	4X4 - Front Axles- W/ Outside Lock Rings	DD	1,2	600.ATV501
DIESEL 455	2001	4X4 - Prop Shaft - from 12/07/00	DD	3,4	600.ATV500
DIESEL 455	2001	4X4 - Prop Shaft - to 12/07/00	DD	3,4	N/A
DIESEL 455	2000	4X4 - Front Axles	DD	1,2	600.ATV501
DIESEL 455	1999	4X4 - Front Axles	DD	1,2	600.ATV501
DIESEL 455	1999	4X4 - Prop Shaft	DD	3,4	600.ATV500
DIESEL 455	1999	4X4 - Rear Axles	DD	7,10	600.ATV502
DIESEL 455	1999	4X4 - Rear Axles	DD	8,9	600.ATV503
LUH 500	2002	6X6 - Front Axles	EE	1,2	600.ATV500
LUH 500	2002	6X6 - Prop Shaft	EE	3,4	600.ATV500
MAGNUM 325	2001-02	2X4 - Rear Prop Shaft	AA	1	600.ATV500
MAGNUM 325	2001-02	4X4 - Front Axles- Exc. HDS (Visco-Lok)	BB	7,8	600.ATV501
MAGNUM 325	2001-02	4X4 - Front Axles- HDS (Visco-Lok)	BB	7,8	N/R
MAGNUM 325	2001-02	4X4 - Front Prop Shaft- Exc. HDS (Visco-Lok)	BB	1,3	600.ATV500
MAGNUM 325	2001-02	4X4 - Front Prop Shaft- HDS (Visco-Lok)	BB	1,3	N/A
MAGNUM 325	2001-02	4X4 - Rear Prop Shaft	BB	4	600.ATV500
MAGNUM 325	2000	2X4 - Rear Prop Shaft	AA	1	600.ATV500
MAGNUM 325	2000	4X4 - Front Axles	BB	7,8	600.ATV501
MAGNUM 325	2000	4X4 - Front Prop Shaft	BB	1,3	600.ATV500
MAGNUM 325	2000	4X4 - Rear Prop Shaft	BB	4	600.ATV500
MAGNUM 330	2006	4X4 - Front Prop Shaft	BB	1,3	600.ATV500
MAGNUM 330	2006	4X4 - Rear Prop Shaft	BB	4	600.ATV501
MAGNUM 330	2005	2X4 - Rear Prop Shaft	AA	1	600.ATV501
MAGNUM 330	2005	4X4 - Front Prop Shaft	BB	1,3	600.ATV500
MAGNUM 330	2005	4X4 - Rear Prop Shaft	BB	4	600.ATV501

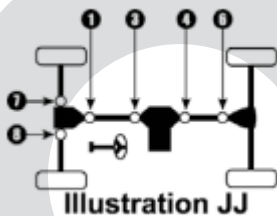

Illustration JJ

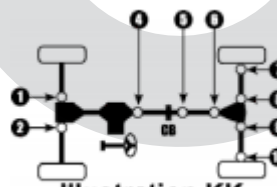

Illustration KK

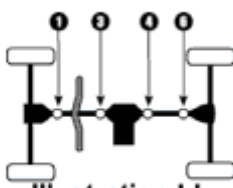

Illustration LL

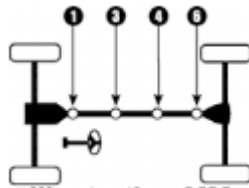

Illustration MM

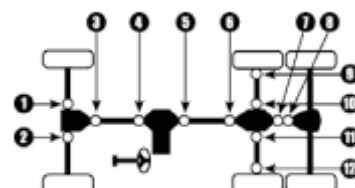

Illustration NN

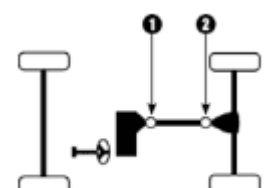

Illustration OO

*See page 6-8 for Universal Joint Chart (ATV)



UNIVERSAL JOINTS

Polaris (Continued)

Model	Year	Application	Figure	Location	ATV City Part No
MAGNUM 330	2003-04	2X4 - Rear Prop Shaft	AA	1	600.ATV501
MAGNUM 330	2003-04	4X4 - Front Axles- Exc. HDS (Visco-Lok)	BB	7,8	600.ATV500
MAGNUM 330	2003-04	4X4 - Front Axles- HDS (Visco-Lok)	BB	7,8	N/R
MAGNUM 330	2003-04	4X4 - Front Prop Shaft	BB	1,3	600.ATV500
MAGNUM 330	2003-04	4X4 - Rear Prop Shaft	BB	4	600.ATV501
MAGNUM 425	1998	4X4	BB	7,8	600.ATV501
MAGNUM 425	1997	4X4	BB	7,8	600.ATV501
MAGNUM 425	1997	6X6	EE	1,2	600.ATV501
MAGNUM 425	1996	4X4- W/ Inside Lock Rings	BB	7,8	600.ATV500
MAGNUM 425	1996	4X4- W/ Outside Lock Rings	BB	7,8	600.ATV501
MAGNUM 425	1996	6X6- W/ Inside Lock Rings	EE	1,2	600.ATV500
MAGNUM 425	1996	6X6- W/ Outside Lock Rings	EE	1,2	600.ATV501
MAGNUM 425	1995	4X4- W/ Inside Lock Rings	BB	7,8	600.ATV500
MAGNUM 425	1995	4X4- W/ Outside Lock Rings	BB	7,8	600.ATV501
MAGNUM 500	2003	4X4 - Front Prop Shaft	BB	1,3	600.ATV500
MAGNUM 500	2003	4X4 - Rear Prop Shaft	BB	4	600.ATV501
MAGNUM 500	2002	4X4 - Front Axles- Exc. HDS (Visco-Lok)	BB	7,8	600.ATV501
MAGNUM 500	2002	4X4 - Front Axles- HDS (Visco-Lok)	BB	7,8	N/R
MAGNUM 500	2002	4X4 - Front Prop Shaft	BB	1,3	600.ATV500
MAGNUM 500	2002	4X4 - Rear Prop Shaft	BB	4	600.ATV500
MAGNUM 500	2001	4X4 - Front Axles- Exc. HDS (Visco-Lok)	BB	7,8	600.ATV501
MAGNUM 500	2001	4X4 - Front Axles- HDS (Visco-Lok)	BB	7,8	N/R
MAGNUM 500	2001	4X4 - Front Prop Shaft- Exc. HDS (Visco-Lok)	BB	1,3	600.ATV500
MAGNUM 500	2001	4X4 - Front Prop Shaft- HDS (Visco-Lok)	BB	1,3	N/A
MAGNUM 500	2001	4X4 - Rear Prop Shaft	BB	4	600.ATV500
MAGNUM 500	1999-00	4X4 - Front Axles	BB	7,8	600.ATV501
MAGNUM 500	1999-00	4X4 - Front Prop Shaft	BB	1,3	600.ATV500
MAGNUM 500	1999-00	4X4 - Rear Prop Shaft	BB	4	N/A

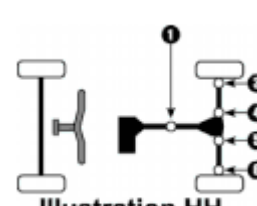
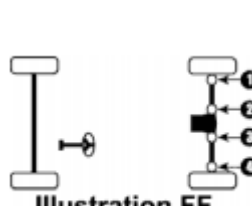
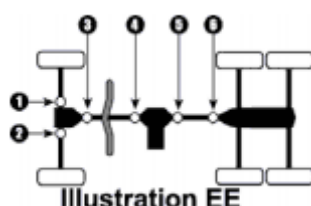
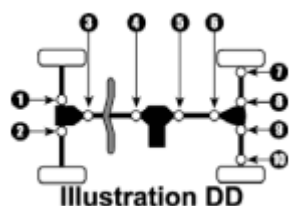
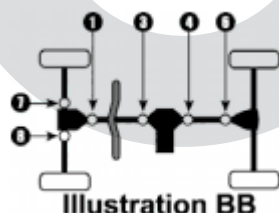
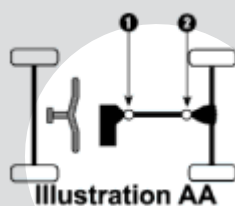

*See page 6-8 for Universal Joint Chart (ATV)



UNIVERSAL JOINTS

Polaris (Continued)

Model	Year	Application	Figure	Location	ATV City Part No
PHOENIX 200	2005-10	2X4	AA	1	600.ATV602
PTV	2002	4X4 - Series 10 PPS - Front Prop Shaft	BB	1,3	600.ATV500
PTV	2002	4X4 - Series 10 PPS - Rear Prop Shaft	BB	4	600.ATV500
PTV	2002	6X6 - Series 10 PPS - Front Axles	NN	1,2	600.ATV500
PTV	2002	6X6 - Series 10 PPS - Front Prop Shaft	NN	3,4	600.ATV500
PTV	2002	6X6 - Series 10 PPS - Rear Prop Shaft	NN	5	N/A
RANGER	2003-04	2X4 - Series 11	OO	1,2	600.ATV500
RANGER	2003-04	4X4 - Series 11- Front Axles	JJ	7,8	600.ATV500
RANGER	2003-04	4X4 - Series 11- Front Prop Shaft	JJ	1,3	600.ATV500
RANGER	2003-04	4X4 - Series 11- Rear Prop Shaft	JJ	4,6	600.ATV500
RANGER	2003-04	6X6 - Series 11- Coupler Shaft	NN	7,8	600.ATV500
RANGER	2003-04	6X6 - Series 11- Front Axles	NN	1,2	600.ATV500
RANGER	2003-04	6X6 - Series 11- Front Prop Shaft	NN	3,4	600.ATV500
RANGER	2003-04	6X6 - Series 11- Middle Axles	NN	9,10,11,12	600.ATV502
RANGER	2003-04	6X6 - Series 11- Rear Prop Shaft	NN	6	600.ATV500
RANGER	2002	2X4 - Series 10	OO	1,2	600.ATV500
RANGER	2002	4X4 - Series 10- Front Axles	JJ	7,8	600.ATV500
RANGER	2002	4X4 - Series 10- Front Prop Shaft	JJ	1,3	600.ATV500
RANGER	2002	4X4 - Series 10- Rear Prop Shaft	JJ	4,6	600.ATV500
RANGER	2002	6X6 - Series 10- Coupler Shaft	NN	7,8	600.ATV500
RANGER	2002	6X6 - Series 10- Front Axles	NN	1,2	600.ATV500
RANGER	2002	6X6 - Series 10- Front Prop Shaft	NN	3,4	600.ATV500
RANGER	2002	6X6 - Series 10- Middle Axles	NN	9,10,11,12	600.ATV502
RANGER	2002	6X6 - Series 10- Rear Prop Shaft	NN	6	600.ATV500
RANGER	1999-01	6X6 - Front Axles	NN	1,2	600.ATV500
RANGER	1999-01	6X6 - Front Prop Shaft	NN	3,4	600.ATV500
RANGER	1999-01	6X6 - Middle Axles	NN	9,10,11,12	600.ATV502

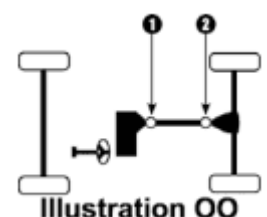
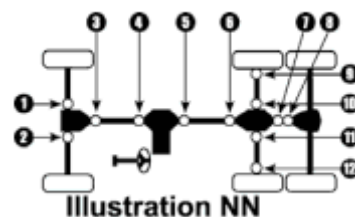
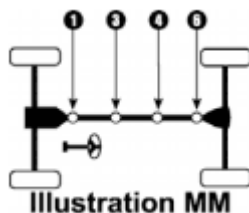
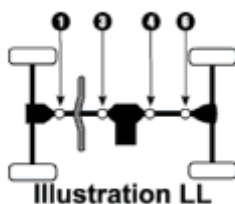
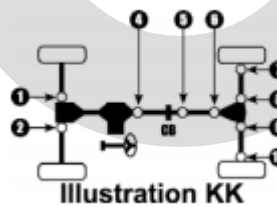
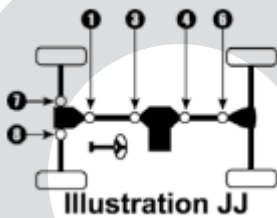

*See page 6-8 for Universal Joint Chart (ATV)



UNIVERSAL JOINTS

Polaris (Continued)

Model	Year	Application	Figure	Location	ATV City Part No
RANGER	1999-01	6X6 - Rear Prop Shaft	NN	6	600.ATV500
RANGER 400	2010-13	4X4 - Front Prop Shaft	JJ	1,3	600.ATV500
RANGER 500	2011-13	4X4 - Crew (Front Prop Shaft)	PP	1,2,3	600.ATV500
RANGER 500	2011-13	4X4 - Exc. Crew (Front Prop Shaft)	JJ	1,3	600.ATV500
RANGER 500	2010	4X4 - Front Prop Shaft	JJ	1,3	600.ATV500
RANGER 500	2008-09	2X4	OO	1,2	600.ATV500
RANGER 500	2008-09	4X4 - Front Prop Shaft	JJ	1,3	600.ATV500
RANGER 500	2008-09	4X4 - Rear Prop Shaft	JJ	4,6	600.ATV500
RANGER 500	2006-07	2X4	OO	1,2	600.ATV500
RANGER 500	2006-07	4X4 - Front Prop Shaft	JJ	1,3	600.ATV500
RANGER 500	2006-07	4X4 - Rear Prop Shaft	JJ	4,6	600.ATV500
RANGER 500	2005	2X4	OO	1,2	600.ATV500
RANGER 500	2005	4X4 - Front Prop Shaft	JJ	1,3	600.ATV500
RANGER 500	2005	4X4 - Rear Prop Shaft	JJ	4,6	600.ATV500
RANGER 500	2005	6X6 - Coupler Shaft	NN	7,8	600.ATV500
RANGER 500	2005	6X6 - Front Axles	NN	1,2	600.ATV500
RANGER 500	2005	6X6 - Front Prop Shaft	NN	3,4	600.ATV500
RANGER 500	2005	6X6 - Middle Axles	NN	9,10,11,12	600.ATV502
RANGER 500	2005	6X6 - Rear Prop Shaft	NN	5,6	600.ATV500
RANGER 570 RZR	2012-13	4X4 - Front Prop Shaft	JJ	1,3	600.ATV500
RANGER 700	2008-09	4X4 - Front Prop Shaft	JJ	1,3	600.ATV500
RANGER 700	2008-09	4X4 - Rear Prop Shaft	JJ	4,6	600.ATV500
RANGER 700	2008-09	6X6 - Coupler Shaft	NN	7,8	600.ATV500
RANGER 700	2008-09	6X6 - Front Prop Shaft	NN	3,4	600.ATV500
RANGER 700	2008-09	6X6 - Rear Prop Shaft	NN	5,6	600.ATV500
RANGER 700	2006-07	4X4 - XP - Front Prop Shaft	JJ	1,3	600.ATV500
RANGER 700	2006-07	4X4 - XP - Rear Prop Shaft	JJ	4,6	600.ATV500
RANGER 700	2006-07	6X6 - Coupler Shaft	NN	7,8	600.ATV500
RANGER 700	2006-07	6X6 - Front Prop Shaft	NN	3,4	600.ATV500
RANGER 700	2006-07	6X6 - Rear Prop Shaft	NN	5,6	600.ATV500
RANGER 700	2005	4X4 - XP - Front Prop Shaft	JJ	1,3	600.ATV500

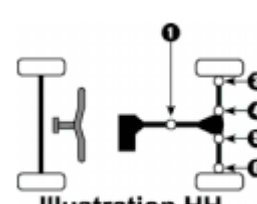
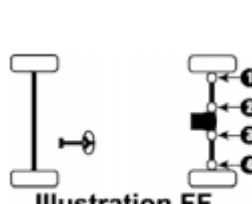
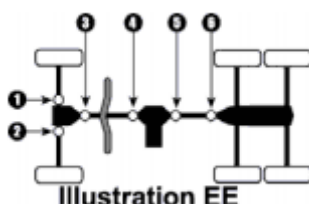
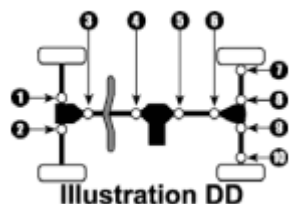
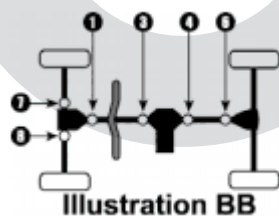
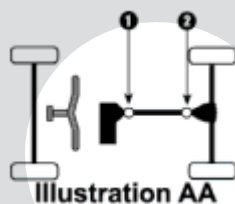

*See page 6-8 for Universal Joint Chart (ATV)

UNIVERSAL JOINTS



Polaris (Continued)

Model	Year	Application	Figure	Location	ATV City Part No
RANGER 700	2005	4X4 - XP - Rear Prop Shaft	JJ	4,6	600.ATV500
RANGER 800	2010-13	4X4 - EFI Crew - (Prop Shaft)	PP	1,2,3	600.ATV500
RANGER 800	2010-13	4X4 - Exc. EFI Crew (Front Shaft)	JJ	1,3	600.ATV500
RANGER 800	2010-13	6X6 - Coupler Shaft	NN	7,8	600.ATV500
RANGER 800	2010-13	6X6 - Front Prop Shaft	NN	3,4	600.ATV500
RANGER 800	2010-13	6X6 - Rear Prop Shaft	NN	5,6	600.ATV500
RANGER 800 RZR	2011-13	4X4 - 4 Seater - Front Prop Shaft	PP	1,2,3	600.ATV500
RANGER 800 RZR	2011-13	4X4 - Exc. 4 Seater - Front Prop Shaft	JJ	1,3	600.ATV500
RANGER 800 RZR	2008-10	4X4 - Front Prop Shaft	JJ	1,3	600.ATV500
RANGER 900	2013	4X4 - Diesel - Front Prop Shaft	PP	1,2,3	600.ATV500
RANGER 900	2013	4X4 - Diesel - Rear Prop Shaft	PP	4,6	600.ATV500
RANGER 900	2013	4X4 - Diesel Crew - Front Prop Shaft	PP	1,2,3	600.ATV500
RANGER 900	2013	4X4 - Diesel Crew - Rear Prop Shaft	PP	4,6	600.ATV500
RANGER 900	2013	4X4 - XP - Front Prop Shaft	JJ	1,3	600.ATV500
RANGER 900	2011-12	4X4 - Front Prop Shaft	PP	1,2,3	600.ATV500
RANGER 900	2011-12	4X4 - XP - Rear Prop Shaft	PP	4,6	600.ATV500
RANGER 900 RZR	2012-13	4X4 - 4 Seater - Front Prop Shaft	PP	1,2,3	600.ATV500
RANGER 900 RZR	2012-13	4X4 - Exc. 4 Seater - Front Prop Shaft	JJ	1,3	600.ATV500
RANGER 900 RZR	2011	4X4 - Front Prop Shaft	JJ	1,3	600.ATV500
RANGER EV (Electric)	2010-13	4X4 - Front Prop Shaft	JJ	1,3	600.ATV500
RANGER EV LSV (Electric)	2011-12	4X4 - Front Prop Shaft	JJ	1,3	600.ATV500
RANGER MVRS	2009	2X4	OO	1,2	600.ATV500
RANGER MVRS	2008	4X4 - Front Prop Shaft	JJ	1,3	600.ATV500
RANGER MVRS	2008	4X4 - Rear Prop Shaft	JJ	4,6	600.ATV500
RANGER TM	2004-06	2X4	OO	1,2	600.ATV500
SAWTOOTH 200	2006-07	2X4	OO	1	600.ATV602
SCRAMBLER 400	1998-02	4X4 - Front Axle- W/ Inside Lock Rings	BB	7,8	600.ATV500

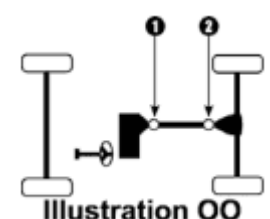
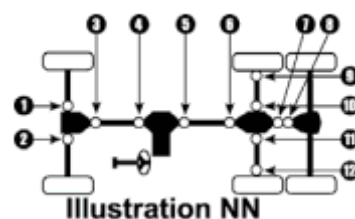
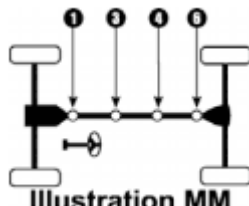
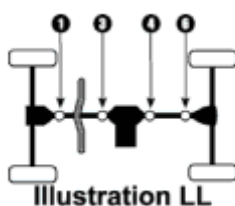
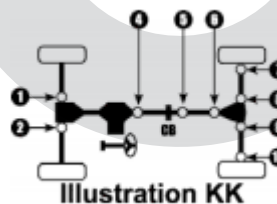
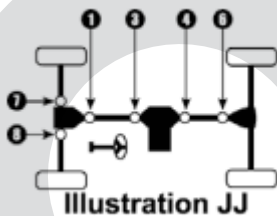

*See page 6-8 for Universal Joint Chart (ATV)



UNIVERSAL JOINTS

Polaris (Continued)

Model	Year	Application	Figure	Location	ATV City Part No
SCRAMBLER 400	1998-02	4X4- Front Axle- W/ Outside Lock Rings	BB	7,8	600.ATV501
SCRAMBLER 400	1998-02	4X4- Prop Shaft	BB	1,3	600.ATV500
SCRAMBLER 400	1995-97	4X4- W/ Inside Lock Rings	BB	7,8	600.ATV500
SCRAMBLER 400	1995-97	4X4- W/ Outside Lock Rings	BB	7,8	600.ATV501
SCRAMBLER 500	2010	4X4- Prop Shaft	BB	1,3	600.ATV500
SCRAMBLER 500	1999-09	4X4- Front Axles	BB	7,8	600.ATV500
SCRAMBLER 500	1999-09	4X4- Prop Shaft	BB	1,3	600.ATV500
SCRAMBLER 500	1998	4X4- Front Axles	BB	7,8	600.ATV501
SCRAMBLER 500	1998	4X4- Prop Shaft	BB	1,3	600.ATV500
SCRAMBLER 500	1997	4X4	BB	7,8	600.ATV501
SPORTSMAN 300	2008-10	4X4 - Front Prop Shaft	JJ	1,3	600.ATV500
SPORTSMAN 335	1999-00	4X4- Front Axles	DD	1,2	600.ATV501
SPORTSMAN 335	1999-00	4X4- Prop Shaft	DD	3,4	600.ATV500
SPORTSMAN 335	1999-00	4X4- Rear Axles	DD	7,10	600.ATV502
SPORTSMAN 335	1999-00	4X4- Rear Axles	DD	8,9	600.ATV503
SPORTSMAN 400	2008-10	4X4- Prop Shaft	BB	1,3	600.ATV500
SPORTSMAN 400	2005	4X4- Prop Shaft	BB	1,3	600.ATV500
SPORTSMAN 400	2002-04	4X4- Front Axles	BB	7,8	600.ATV500
SPORTSMAN 400	2002-04	4X4- Prop Shaft	BB	1,3	600.ATV500
SPORTSMAN 400	2001	4X4- Front Axles	BB	7,8	600.ATV501
SPORTSMAN 400	2001	4X4- Prop Shaft	BB	1,3	600.ATV500
SPORTSMAN 400	1997	4X4	BB	7,8	600.ATV501
SPORTSMAN 400	1995-96	4X4- W/ Inside Lock Rings	BB	7,8	600.ATV500
SPORTSMAN 400	1995-96	4X4- W/ Outside Lock Rings	BB	7,8	600.ATV501
SPORTSMAN 400	1993-94	4X4	BB	7,8	600.ATV500
SPORTSMAN 450	2006-07	4X4	BB	1,3	600.ATV500
SPORTSMAN 500	2009-10	4X4- Prop Shaft	BB	1,3	600.ATV500
SPORTSMAN 500	2005-08	4X4- Prop Shaft	BB	1,3	600.ATV500
SPORTSMAN 500	2005-08	6X6- Front Axles	EE	1,2	600.ATV500

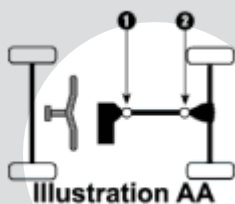

Illustration AA

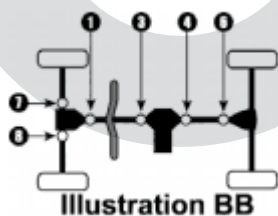

Illustration BB

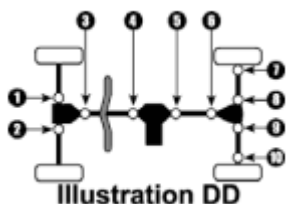

Illustration DD

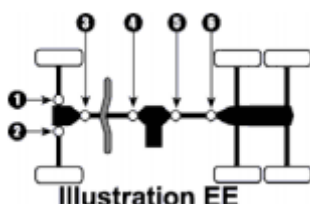

Illustration EE

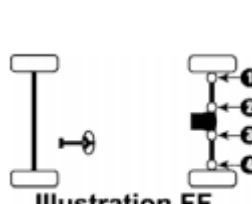

Illustration FF

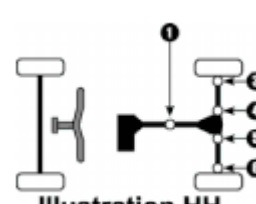

Illustration HH

*See page 6-8 for Universal Joint Chart (ATV)



UNIVERSAL JOINTS

Polaris (Continued)

Model	Year	Application	Figure	Location	ATV City Part No
SPORTSMAN 500	2005-08	6X6- Prop Shaft	EE	3,4	600.ATV500
SPORTSMAN 500	2004	4X4- Front Axles	BB	7,8	600.ATV500
SPORTSMAN 500	2004	4X4- Prop Shaft - W/ Inside Lock Rings	BB	1,3	600.ATV500
SPORTSMAN 500	2004	4X4- Prop Shaft - W/ Outside Lock Rings	BB	1,3	600.ATV501
SPORTSMAN 500	2004	6X6- Front Axles	EE	1,2	600.ATV500
SPORTSMAN 500	2004	6X6- Prop Shaft	EE	3,4	600.ATV500
SPORTSMAN 500	2002-03	4X4- Front Axles	BB	7,8	600.ATV500
SPORTSMAN 500	2002-03	4X4- Prop Shaft	BB	1,3	600.ATV500
SPORTSMAN 500	2002-03	6X6- Front Axles	EE	1,2	600.ATV500
SPORTSMAN 500	2002-03	6X6- Prop Shaft	EE	3,4	600.ATV500
SPORTSMAN 500	1999-01	4X4- Front Axles	BB	7,8	600.ATV501
SPORTSMAN 500	1999-01	4X4- Prop Shaft - W/ Inside Lock Rings	BB	1,3	600.ATV500
SPORTSMAN 500	1999-01	4X4- Prop Shaft - W/ Outside Lock Rings	BB	1,3	600.ATV501
SPORTSMAN 500	1999-01	6X6- Front Axles	EE	1,2	600.ATV501
SPORTSMAN 500	1999-01	6X6- Prop Shaft	EE	3,4	600.ATV500
SPORTSMAN 500	1998	4X4- Front Axles	DD	1,2	600.ATV501
SPORTSMAN 500	1998	4X4- Prop Shaft	DD	3,4	600.ATV500
SPORTSMAN 500	1998	4X4- Rear Axles	DD	7,10	600.ATV502
SPORTSMAN 500	1998	4X4- Rear Axles	DD	8,9	600.ATV503
SPORTSMAN 500	1997	4X4- Front Axles	DD	1,2	600.ATV500
SPORTSMAN 500	1997	4X4- Prop Shaft	DD	3,4	600.ATV500
SPORTSMAN 500	1997	4X4- Rear Axles	DD	7,10	600.ATV502
SPORTSMAN 500	1997	4X4- Rear Axles	DD	8,9	600.ATV503
SPORTSMAN 500	1996	4X4- Front Axles- W/ Inside Snap Rings	DD	1,2	600.ATV500
SPORTSMAN 500	1996	4X4- Front Axles- W/ Outside Snap Rings	DD	1,2	600.ATV501
SPORTSMAN 500	1996	4X4- Prop Shaft	DD	3,4	600.ATV500
SPORTSMAN 500	1996	4X4- Rear Axles	DD	7,10	600.ATV502
SPORTSMAN 500	1996	4X4- Rear Axles	DD	8,9	600.ATV503
SPORTSMAN 500 X2	2006-09	4X4 - Prop Shaft	BB	1,3	600.ATV500

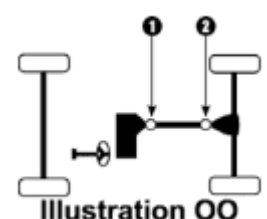
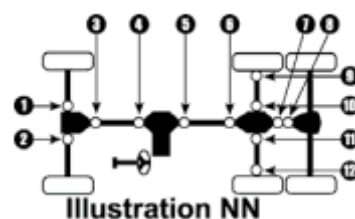
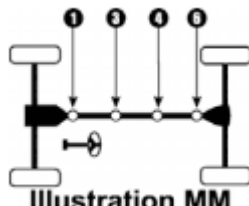
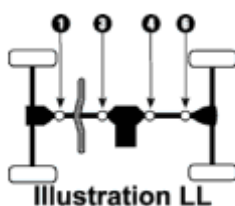
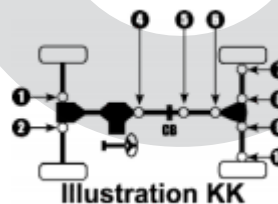
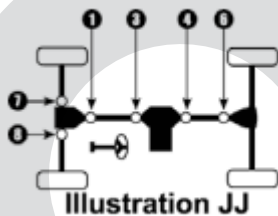

*See page 6-8 for Universal Joint Chart (ATV)

UNIVERSAL JOINTS



Polaris (Continued)

Model	Year	Application	Figure	Location	ATV City Part No
SPORTSMAN 550 X2	2010	4X4 - Front Prop Shaft	BB	1,3	600.ATV500
SPORTSMAN 550 X2	2010	4X4 - Rear Prop Shaft	BB	4,6	600.ATV500
SPORTSMAN 550 XP	2009-10	4X4 - Front Prop Shaft	BB	1,3	600.ATV500
SPORTSMAN 550 XP	2009-10	4X4 - Rear Prop Shaft	BB	4,6	600.ATV500
SPORTSMAN 600	2005	4X4- Front Axles	BB	7,8	N/R
SPORTSMAN 600	2005	4X4- Front Prop Shaft	BB	1,3	600.ATV500
SPORTSMAN 600	2005	4X4- Rear Prop Shaft	BB	4,6	600.ATV500
SPORTSMAN 600	2003-04	4X4- Front Axles	BB	7,8	600.ATV500
SPORTSMAN 600	2003-04	4X4- Front Prop Shaft	BB	1,3	600.ATV500
SPORTSMAN 600	2003-04	4X4- Rear Prop Shaft	BB	4,6	600.ATV500
SPORTSMAN 700	2005-07	4X4- Front Prop Shaft	BB	1,3	600.ATV500
SPORTSMAN 700	2005-07	4X4- Rear Prop Shaft	BB	4,6	600.ATV500
SPORTSMAN 700	2002-04	4X4- Front Axles	BB	7,8	600.ATV500
SPORTSMAN 700	2002-04	4X4- Front Prop Shaft	BB	1,3	600.ATV500
SPORTSMAN 700	2002-04	4X4- Rear Prop Shaft	BB	4,6	600.ATV500
SPORTSMAN 800	2009-10	4X4- Front Prop Shaft	BB	1,3	600.ATV500
SPORTSMAN 800	2009-10	4X4- Rear Prop Shaft	BB	4,6	600.ATV500
SPORTSMAN 800	2009-10	6X6- Front Prop Shaft	BB	1,3	600.ATV500
SPORTSMAN 800	2009-10	6X6- Rear Prop Shaft	BB	4,6	600.ATV500
SPORTSMAN 800	2005-08	4X4- Front Prop Shaft	BB	1,3	600.ATV500
SPORTSMAN 800	2005-08	4X4- Rear Prop Shaft	BB	4,6	600.ATV500
SPORTSMAN 800 X2	2007-09	4X4 - Prop Shaft	BB	1,3	600.ATV500
SPORTSMAN 850	2010	4X4- Front Prop Shaft	BB	1,3	600.ATV500
SPORTSMAN 850	2010	4X4- Rear Prop Shaft	BB	4,6	600.ATV500
SPORTSMAN 850 XP	2009-10	4X4 - Front Prop Shaft	BB	1,3	600.ATV500
SPORTSMAN 850 XP	2009-10	4X4 - Rear Prop Shaft	BB	4,6	600.ATV500
SPORTSMAN MV7	2007	4X4- Front Prop Shaft	BB	1,3	600.ATV500
SPORTSMAN MV7	2007	4X4- Rear Prop Shaft	BB	4,6	600.ATV500
SPORTSMAN MV7	2007	6X6- Front Axles	EE	1,2	600.ATV500
SPORTSMAN MV7	2007	6X6- Front Prop Shaft	EE	3,4	600.ATV500

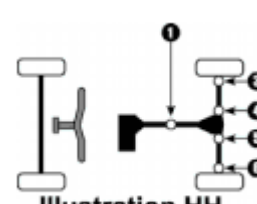
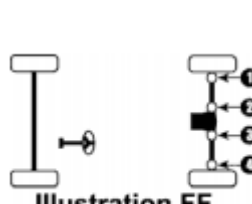
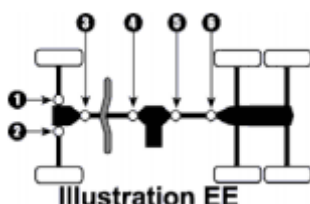
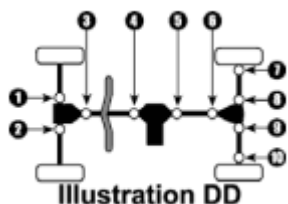
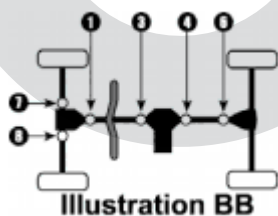
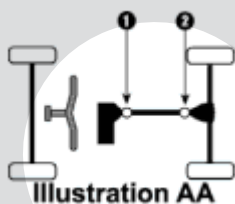

*See page 6-8 for Universal Joint Chart (ATV)



UNIVERSAL JOINTS

Polaris (Continued)

Model	Year	Application	Figure	Location	ATV City Part No
SPORTSMAN MV7	2005-06	4X4- Front Prop Shaft	BB	1,3	600.ATV500
SPORTSMAN MV7	2005-06	4X4- Rear Prop Shaft	BB	4,6	600.ATV500
TRAIL BOSS 250	1987-92	4x4	BB	7,8	600.ATV500
TRAIL BOSS 350L	1990-92	4x4	BB	7,8	600.ATV500
UTV (Utility Task Vehicle)	2003-04	2X4 - Series 11 PPS	OO	1,2	600.ATV500
UTV (Utility Task Vehicle)	2003-04	4X4 - Series 11 PPS - Front Axles	JJ	7,8	600.ATV500
UTV (Utility Task Vehicle)	2003-04	4X4 - Series 11 PPS - Front Prop Shaft	JJ	1,3	600.ATV500
UTV (Utility Task Vehicle)	2003-04	4X4 - Series 11 PPS - Rear Prop Shaft	JJ	4,6	600.ATV500
UTV (Utility Task Vehicle)	2003-04	6X6 - Series 11 PPS - Coupler Shaft	NN	7,8	600.ATV500
UTV (Utility Task Vehicle)	2003-04	6X6 - Series 11 PPS - Front Axles	NN	1,2	600.ATV500
UTV (Utility Task Vehicle)	2003-04	6X6 - Series 11 PPS - Front Prop Shaft	NN	3,4	600.ATV500
UTV (Utility Task Vehicle)	2003-04	6X6 - Series 11 PPS - Middle Axles	NN	9,10,11,12	600.ATV502
UTV (Utility Task Vehicle)	2003-04	6X6 - Series 11 PPS - Rear Prop Shaft	NN	6	600.ATV500
UTV (Utility Task Vehicle)	2002	2X4 - Series 10 PPS	OO	1,2	600.ATV500
UTV (Utility Task Vehicle)	2002	4X4 - Series 10 PPS - Front Axles	JJ	7,8	600.ATV500
UTV (Utility Task Vehicle)	2002	4X4 - Series 10 PPS - Front Prop Shaft	JJ	1,3	600.ATV500
UTV (Utility Task Vehicle)	2002	4X4 - Series 10 PPS - Rear Prop Shaft	JJ	4,6	600.ATV500
WORKER 335	1999	4X4 - Front Axles	DD	1,2	600.ATV501
WORKER 335	1999	4X4 - Prop Shaft	DD	3,4	600.ATV500
WORKER 335	1999	4X4 - Rear Axles	DD	7,10	600.ATV502
WORKER 335	1999	4X4 - Rear Axles	DD	8,9	600.ATV503
WORKER 500	1999	4X4 - Front Axles	DD	1,2	600.ATV501
WORKER 500	1999	4X4 - Prop Shaft	DD	3,4	600.ATV501
XPEDITION 325	2000-02	4X4 - Front Axles	DD	1,2	600.ATV501
XPEDITION 325	2000-02	4X4 - Front Prop Shaft	DD	3,4	600.ATV500
XPEDITION 325	2000-02	4X4 - Rear Prop Shaft	DD	5	600.ATV500
XPEDITION 425	2002	4X4 - Front Axles	DD	1,2	600.ATV500
XPEDITION 425	2002	4X4 - Front Prop Shaft	DD	3,4	600.ATV500
XPEDITION 425	2002	4X4 - Rear Prop Shaft	DD	5	600.ATV500

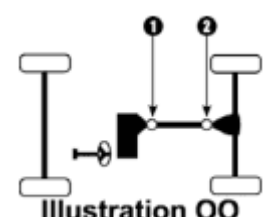
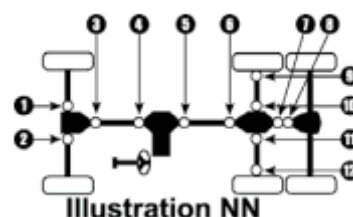
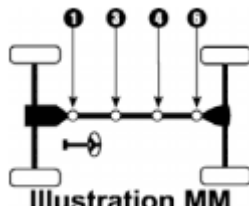
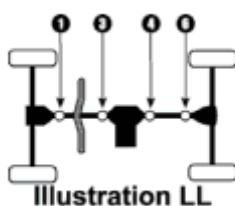
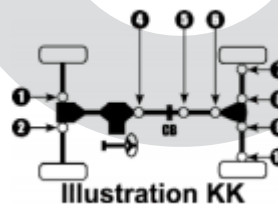
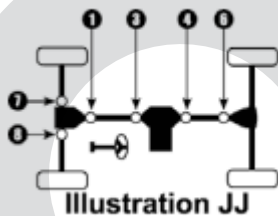

*See page 6-8 for Universal Joint Chart (ATV)



UNIVERSAL JOINTS

Polaris (Continued)

Model	Year	Application	Figure	Location	ATV City Part No
XPEDITION 425	2000-01	4X4 - Front Axles	DD	1,2	600.ATV501
XPEDITION 425	2000-01	4X4 - Front Prop Shaft	DD	3,4	600.ATV500
XPEDITION 425	2000-01	4X4 - Rear Prop Shaft	DD	5	600.ATV500
XPLORER 250	2000-02	4X4 - Front Axles	BB	7,8	600.ATV500
XPLORER 250	2000-02	4X4 - Prop Shaft	BB	1,3	600.ATV500
XPLORER 300	1996-99	4X4	BB	7,8	600.ATV501
XPLORER 400	1999-02	4X4- Front Axles	BB	7,8	600.ATV500
XPLORER 400	1999-02	4X4- Prop Shaft	BB	1,3	600.ATV500
XPLORER 400	1997-98	4X4	BB	7,8	600.ATV501
XPLORER 400	1995-96	4X4- W/ Inside Lock Rings	BB	7,8	600.ATV500
XPLORER 400	1995-96	4X4- W/ Outside Lock Rings	BB	7,8	600.ATV501
XPLORER 500	1997	4X4 - Front Axles	DD	1,2	600.ATV500
XPLORER 500	1997	4X4 - Prop Shaft	DD	3,4	600.ATV500
XPLORER 500	1997	4X4 - Rear Axles	DD	7,10	600.ATV502
XPLORER 500	1997	4X4 - Rear Axles	DD	8,9	600.ATV503

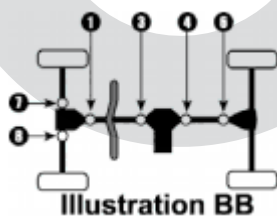
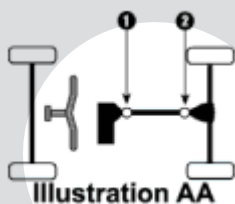

Suzuki

Model	Year	Application	Figure	Location	ATV City Part No
EIGER 400	2002-07	2WD	HH	1	600.ATV405
EIGER 400	2002-07	4WD - Front Bevel Gear	LL	1	600.ATV405
EIGER 400	2002-07	4WD - Secondary Drive	LL	4,6	600.ATV405
KING QUAD 300	1991-93	4WD - Rear Axles	HH	3,6	600.ATV403
KING QUAD 300	1991-93	4WD - Rear Axles	HH	4,5	600.ATV404
KING QUAD 300	2001-02	4WD - Secondary Drive	HH	1	600.ATV405
KING QUAD 300	1996-00	4WD - Rear Axles	HH	3,6	600.ATV403
KING QUAD 300	1996-00	4WD - Secondary Drive	HH	1	600.ATV400

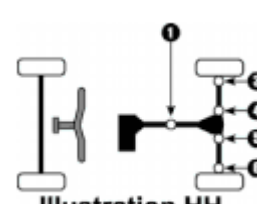
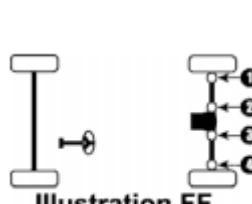
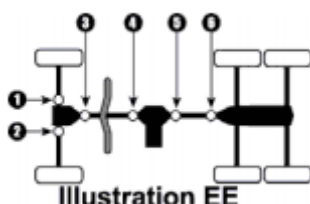
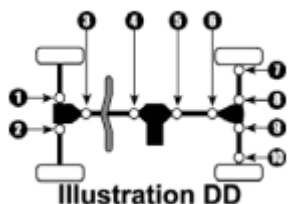

*See page 6-8 for Universal Joint Chart (ATV)



UNIVERSAL JOINTS

Suzuki (Continued)

Model	Year	Application	Figure	Location	ATV City Part No
KING QUAD 300	1991-93	4WD - Rear Axles	HH	3,6	600.ATV403
KING QUAD 300	1991-93	4WD - Rear Axles	HH	4,5	600.ATV404
KING QUAD 400	2010-12	4WD - Front Bevel Gear	LL	3	600.ATV405
KING QUAD 400	2010-12	4WD - Secondary Drive	LL	4,6	600.ATV405
KING QUAD 400	2008-09	2WD	HH	1	600.ATV405
KING QUAD 400	2008-09	4WD - Front Bevel Gear	LL	3	600.ATV405
KING QUAD 400	2008-09	4WD - Secondary Drive	LL	4,6	600.ATV405
KING QUAD 450	2007-10	4WD - Front Bevel Gear	LL	3	600.ATV406
KING QUAD 400	2010-12	4WD - Front Bevel Gear	LL	3	600.ATV405
KING QUAD 400	2010-12	4WD - Secondary Drive	LL	4,6	600.ATV405
KING QUAD 400	2008-09	2WD	HH	1	600.ATV405
KING QUAD 400	2008-09	4WD - Front Bevel Gear	LL	3	600.ATV405
KING QUAD 400	2008-09	4WD - Secondary Drive	LL	4,6	600.ATV405
KING QUAD 450	2007-10	4WD - Front Bevel Gear	LL	3	600.ATV406
KING QUAD 450	2007-10	4WD - Secondary Drive	LL	6	600.ATV400
KING QUAD 500	2009-11	4WD - Front Bevel Gear	LL	3	600.ATV406
KING QUAD 500	2009-11	4WD - Secondary Drive	LL	6	600.ATV400
KING QUAD 700	2005-07	4WD - Front Bevel Gear	LL	3	600.ATV406
KING QUAD 700	2005-07	4WD - Secondary Drive	LL	6	600.ATV400
KING QUAD 750	2008-12	4WD - Front Bevel Gear	LL	3	600.ATV406
KING QUAD 750	2008-12	4WD - Secondary Drive	LL	6	600.ATV400
OZARK 250	2012	2WD	HH	1	600.ATV405
OZARK 250	2002-09	2WD	HH	1	600.ATV405
QUAD MASTER 500	2001	4WD - Front Bevel Gear	LL	1	600.ATV405
QUAD MASTER 500	2001	4WD - Secondary Drive	LL	4,6	600.ATV400
QUAD MASTER 500	2000	4WD - Front Bevel Gear	LL	1	600.ATV400
QUAD MASTER 500	2000	4WD - Secondary Drive	LL	4	600.ATV400
QUAD RUNNER 250	2002	4WD - Rear Axles	HH	3,6	600.ATV402
QUAD RUNNER 250	2002	4WD - Rear Axles	HH	4,5	600.ATV407
QUAD RUNNER 250	2002	4WD - Secondary Drive	HH	1	600.ATV405

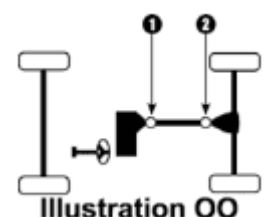
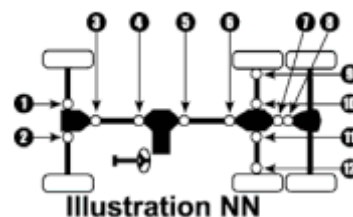
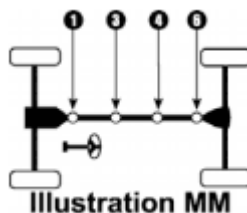
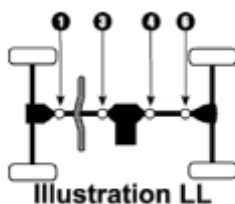
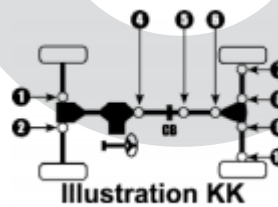
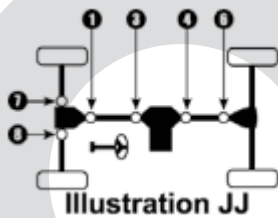

*See page 6-8 for Universal Joint Chart (ATV)



UNIVERSAL JOINTS

Suzuki (Continued)

Model	Year	Application	Figure	Location	ATV City Part No
QUAD RUNNER 250	2001	2WD	HH	3,6	600.ATV402
QUAD RUNNER 250	2001	2WD	HH	4,5	600.ATV407
QUAD RUNNER 250	2001	4WD - Rear Axles	HH	3,6	600.ATV402
QUAD RUNNER 250	2001	4WD - Rear Axles	HH	4,5	600.ATV407
QUAD RUNNER 250	2001	4WD - Secondary Drive	HH	1	600.ATV405
QUAD RUNNER 250	1995-00	2WD	HH	3,6	600.ATV402
QUAD RUNNER 250	1995-00	4WD - Rear Axles	HH	3,6	600.ATV402
QUAD RUNNER 250	1995-00	4WD - Secondary Drive	HH	1	600.ATV400
QUAD RUNNER 250	1994	2WD	HH	3,6	600.ATV402
QUAD RUNNER 250	1994	2WD	HH	4,5	600.ATV404
QUAD RUNNER 250	1994	4WD - Rear Axles	HH	3,6	600.ATV402
QUAD RUNNER 250	1994	4WD - Secondary Drive	HH	1	600.ATV400
QUAD RUNNER 250	1988-93	2WD	HH	3,6	600.ATV402
QUAD RUNNER 250	1988-93	2WD	HH	4,5	600.ATV404
QUAD RUNNER 250	1988-93	4WD - Rear Axles	HH	3,6	600.ATV402
QUAD RUNNER 250	1988-93	4WD - Rear Axles	HH	4,5	600.ATV404
QUAD RUNNER 250	1988-93	4WD - Secondary Drive	HH	1	600.ATV400
QUAD RUNNER 250	1987	4WD - Rear Axles	HH	3,6	600.ATV401
QUAD RUNNER 250	1987	4WD - Rear Axles	HH	4,5	600.ATV404
QUAD RUNNER 250	1987	4WD - Secondary Drive	HH	1	600.ATV400
QUAD RUNNER 300	1995	4WD - Rear Axles	HH	3,6	600.ATV403
QUAD RUNNER 300	1995	4WD - Secondary Drive	HH	1	600.ATV400
QUAD RUNNER 300	1994	4WD - Rear Axles	HH	3,6	600.ATV403
QUAD RUNNER 300	1994	4WD - Rear Axles	HH	4,5	600.ATV404
QUAD RUNNER 300	1994	4WD - Secondary Drive	HH	1	600.ATV400
QUAD RUNNER 500	2002	4WD - Front Bevel Gear	LL	1	600.ATV405
QUAD RUNNER 500	2002	4WD - Secondary Drive	LL	4,6	600.ATV405
QUAD RUNNER 500	2001	4WD	LL	4,6	600.ATV405
QUAD RUNNER 500	1998-00	4WD	LL	4	600.ATV400
QUAD SPORT 250	2004-09	2WD	HH	1	600.ATV405
QUV UTILITY 620	2005	4WD - Front Prop Shaft	KK	4	600.ATV702

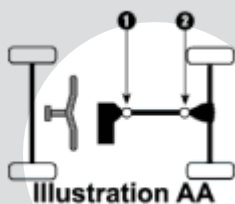

Illustration AA

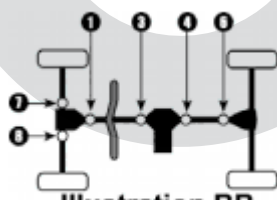

Illustration BB

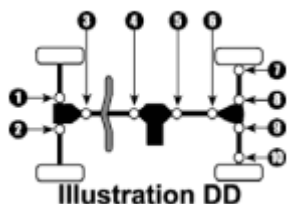

Illustration DD

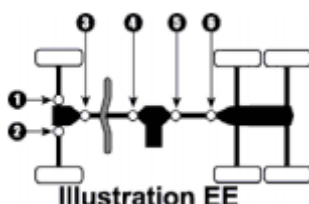

Illustration EE

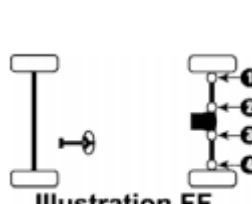

Illustration FF

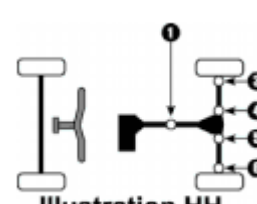

Illustration HH

*See page 6-8 for Universal Joint Chart (ATV)



UNIVERSAL JOINTS

Suzuki (Continued)

Model	Year	Application	Figure	Location	ATV City Part No
QUV UTILITY 620	2005	4WD - Rear Axles	KK	7,8,9,10	600.ATV704
QUV UTILITY 620	2005	4WD - Rear Prop Shaft	KK	5,6	600.ATV702
TWIN PEAKS 700	2004-05	4WD	LL	4	600.ATV703
VINSON 500	2002-07	4WD - Front Bevel Gear	LL	1	600.ATV405
VINSON 500	2002-07	4WD - Secondary Drive	LL	4	600.ATV405
VINSON 500	2002-07	4WD - Secondary Drive	LL	6	600.ATV400

Yamaha

Model	Year	Application	Figure	Location	ATV City Part No
BEAR TRACKER 250	1999-04	2WD	AA	1	600.ATV202
BIG BEAR 250	2007-09	2WD	HH	1	600.ATV202
BIG BEAR 350	1987-99	4WD - Front Drive Shaft	LL	1,3	600.ATV200
BIG BEAR 350	1987-99	4WD - Rear Drive Shaft	LL	4,6	600.ATV201
BIG BEAR 350	1986	4WD - Front Drive Shaft	LL	1,3	600.ATV202
BIG BEAR 400	2007-12	4WD - W/ IRS - (Front Drive Shaft)	LL	1,3	600.ATV202
BIG BEAR 400	2007-12	4WD - W/ IRS - (Rear Drive Shaft)	LL	4,6	600.ATV202
BIG BEAR 400	2006	4WD - Front Drive Shaft	LL	1,3	600.ATV202
BRUIN 250	2005-06	2WD	HH	1	600.ATV202
GRIZZLY 350	2012-14	4WD	LL	4	600.ATV202
GRIZZLY 350	2007-11	2WD	HH	1	600.ATV202
GRIZZLY 350	2007-11	4WD - W/ IRS - (Front Drive Shaft)	LL	1,3	600.ATV202
GRIZZLY 350	2007-11	4WD - W/ IRS - (Rear Drive Shaft)	LL	4,6	600.ATV202
GRIZZLY 350	2007-11	4WD - W/O IRS	LL	4	600.ATV202
GRIZZLY 400	2007-08	4WD - Rear Drive Shaft	LL	4,6	600.ATV202
GRIZZLY 450	2007-14	4WD - W/ IRS - (Front Drive Shaft)	LL	1,3	600.ATV202
GRIZZLY 450	2007-14	4WD - W/ IRS - (Rear Drive Shaft)	LL	4,6	600.ATV202
GRIZZLY 600	1998	4WD - Front Drive Shaft	LL	1,3	600.ATV200
GRIZZLY 600	1998	4WD - Rear Drive Shaft	LL	4,6	600.ATV201

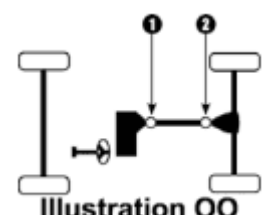
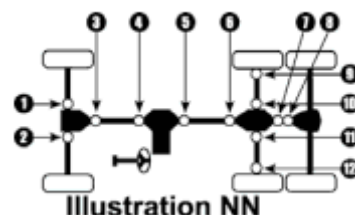
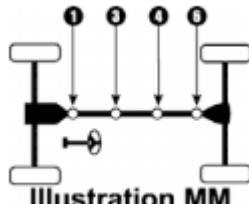
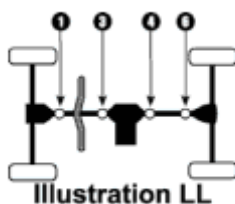
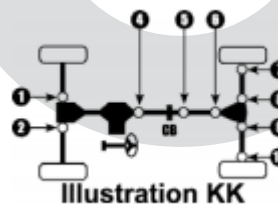
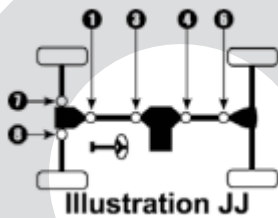

*See page 6-8 for Universal Joint Chart (ATV)

UNIVERSAL JOINTS



Yamaha (Continued)

Model	Year	Application	Figure	Location	ATV City Part No
GRIZZLY 80	2005-08	2WD	HH	1	600.ATV203
KODIAK 400	2005-06	4WD - Rear Drive Shaft	LL	4,6	600.ATV202
KODIAK 400	1998-99	4WD - Front Drive Shaft	LL	1,3	600.ATV202
KODIAK 400	1993-97	4WD - Front Drive Shaft	LL	1,3	600.ATV200
KODIAK 400	1993-97	4WD - Rear Drive Shaft	LL	4,6	600.ATV201
KODIAK 450	2003-06	4WD - Front Drive Shaft	LL	1,3	600.ATV202
KODIAK 450	2003-06	4WD - Rear Drive Shaft	LL	4,6	600.ATV202
MOTO-4 225	1986-88	2WD	AA	1	600.ATV202
MOTO-4 250	1989-91	2WD	AA	1	600.ATV202
RAPTOR 50	2004-08	2WD	HH	1	600.ATV203
RAPTOR 80	2002-08	2WD	HH	1	600.ATV203
RHINO 450	2006-09	4WD - Front Drive Shaft	LL	1,3	600.ATV202
RHINO 660	2004-07	4WD - Front Drive Shaft	LL	1,3	600.ATV202
RHINO 700	2008-13	4WD - Front Drive Shaft	LL	1,3	600.ATV202
TIMBERWOLF 250	1999-00	4WD - Front Drive Shaft	LL	1,3	600.ATV200
TIMBERWOLF 250	1999-00	4WD - Rear Drive Shaft	LL	4	600.ATV202
TIMBERWOLF 250	1994-98	2WD	AA	1	600.ATV202
TIMBERWOLF 250	1994-98	4WD - Front Drive Shaft	LL	1,3	600.ATV200
TIMBERWOLF 250	1994-98	4WD - Rear Drive Shaft	LL	4	600.ATV202
TIMBERWOLF 250	1992-93	2WD	AA	1	600.ATV202
WOLVERINE 350	2006-09	2WD	HH	1	600.ATV202
WOLVERINE 350	1995-98	4WD - Front Drive Shaft	LL	1,3	600.ATV202
WOLVERINE 350	1995-98	4WD - Rear Drive Shaft	LL	4,6	600.ATV201
WOLVERINE 450	2007-10	4WD - Rear Drive Shaft	HH	1	600.ATV202

Bearings

Braking

Bullbars

Cables

Carburettor

Driveline

Electrical

Exhausts

UNIVERSAL JOINT SIZE CHART



<p>ATV200</p>	<p>ATV201</p>	<p>ATV202</p>
<p>ATV400</p>	<p>ATV401</p>	<p>ATV403</p>
<p>ATV404</p>	<p>ATV500</p>	<p>ATV501</p>
<p>ATV502</p>	<p>ATV503</p>	<p>ATV504</p>

UNIVERSAL JOINT SIZE CHART



ATV600	ATV700	ATV702
<p>25mm</p> <p>64mm</p>	<p>30mm</p> <p>16mm</p> <p>41mm</p>	<p>36mm</p> <p>22mm</p> <p>52mm</p>
ATV704		
<p>25mm</p> <p>64mm</p>		

Bearings

Braking

Bullbars

Cables

Carburettor

Driveline

Electrical

Exhausts

ATV/UTV CV AXLES & BOOT KITS



Arctic Cat

Year(s)	DT	Model	Location	Type	Left Side CV	Right Side CV	Outboard CV Boot	Inboard CV Boot
250								
2005	4X4	ALL	R	Complete	610.AC8306	610.AC8306	600.BT23A	600.BT4075H
	2X4	ALL	R	Complete	610.AC8306	610.AC8306	600.BT23A	600.BT4075H
2002-2004	4X4	ALL	F	Complete	610.AC8305	610.AC8305	600.BT23A	600.BT4075G
	4X4	ALL	R	Complete	610.AC8304	610.AC8304	600.BT23A	600.BT4075H
	2X4	ALL	R	Complete	610.AC8304	610.AC8304	600.BT23A	600.BT4075H
2001	4X4	ALL	F	Complete	610.AC8118	610.AC8218	600.BT23A	600.BT4075G
	4X4	ALL	R	Complete	610.AC8304	610.AC8304	600.BT23A	600.BT4075H
	2X4	ALL	R	Complete	610.AC8304	610.AC8304	600.BT23A	600.BT4075H
1999-2000	2X4	ALL	R	Complete	610.AC8304	610.AC8304	600.BT23A	600.BT4075H
300								
2005	4X4	ALL	R	Complete	610.AC8306	610.AC8306	600.BT23A	600.BT4075H
2002-2004	4X4	ALL	F	Complete	610.AC8305	610.AC8305	600.BT23A	600.BT4075G
	4X4	ALL	R	Complete	610.AC8304	610.AC8304	600.BT23A	600.BT4075H
1998-2001	4X4	ALL	F	Complete	610.AC8118	610.AC8218	600.BT23A	600.BT4075G
	4X4	ALL	R	Complete	610.AC8304	610.AC8304	600.BT23A	600.BT4075H
	2X4	ALL	R	Complete	610.AC8304	610.AC8304	600.BT23A	600.BT4075H
375								
2002	4X4	ALL	F	Complete	610.AC8305	610.AC8305	600.BT23A	600.BT4075G
400								
2009-2010	4X4	TRV	F	Complete	610.AC8145	610.AC8245	600.BT23B	600.BT23G
	4X4	TRV	R	Complete	610.AC8311	610.AC8311	600.BT23B	600.BT23G
2007-2008	4X4	FIS	F	Complete	610.AC8145	610.AC8245	600.BT23B	600.BT23G
	4X4	FIS	R	Complete	610.AC8311	610.AC8311	600.BT23B	600.BT23G
	4X4	TRV	F	Complete	610.AC8245	610.AC8245	600.BT23B	600.BT23G
	4X4	TRV	R	Complete	610.AC8311	610.AC8311	600.BT23B	600.BT23G
2006	4X4	FIS	F	Complete	610.AC8145	610.AC8245	600.BT23B	600.BT23G
	4X4	FIS	R	Complete	610.AC8311	610.AC8311	600.BT23B	600.BT23G
	4X4	TBX	F	Complete	610.AC8245	610.AC8245	600.BT23B	600.BT23G
	4X4	TBX	R	Complete	610.AC8311	610.AC8311	600.BT23B	600.BT23G
	4X4	TRV	F	Complete	610.AC8245	610.AC8245	600.BT23B	600.BT23G
	4X4	TRV	R	Complete	610.AC8311	610.AC8311	600.BT23B	600.BT23G
2005	4X4	FIS	F	Complete	610.AC8110	610.AC8210	600.BT23A	600.BT23G
	4X4	FIS	R	Complete	610.AC8311	610.AC8311	600.BT23B	600.BT23G
	4X4	TBX	F	Complete	610.AC8110	610.AC8210	600.BT23A	600.BT23G
	4X4	TBX	R	Complete	610.AC8311	610.AC8311	600.BT23B	600.BT23G
2004	4X4	FIS	F	Complete	610.AC8244	610.AC8244	600.BT23B	600.BT23G
	4X4	FIS	R	Complete	610.AC8244	610.AC8244	600.BT23B	600.BT23G
	4X4	TBX	F	Complete	610.AC8244	610.AC8244	600.BT23B	600.BT23G



ATV/UTV CV AXLES & BOOT KITS

Arctic Cat (continued)

Year(s)	DT	Model	Location	Type	Left Side CV	Right Side CV	Outboard CV Boot	Inboard CV Boot
	4X4	TBX	R	Complete	610.AC8244	610.AC8244	600.BT23B	600.BT23G
	2X4		R	Complete	610.AC8244	610.AC8244	600.BT23B	600.BT23G
2002-2003	4X4	Exc. FIS	F	Complete	610.AC8305	610.AC8305	600.BT23A	600.BT4075G
	4X4	FIS	F	Complete	610.AC8244	610.AC8244	600.BT23B	600.BT23G
	4X4	FIS	R	Complete	610.AC8244	610.AC8244	600.BT23B	600.BT23G
	2X4		R	Complete	610.AC8244	610.AC8244	600.BT23B	600.BT23G
2000-2001	4X4	A/T	F	Complete	610.AC8118	610.AC8218	600.BT23A	600.BT4075G
1998-2001	4X4	M/T	F	Complete	610.AC8218	610.AC8218	600.BT23A	600.BT4075G
500								
2009	4X4	FIS	F	Complete	610.AC8145	610.AC8245	600.BT23B	600.BT23G
	4X4	FIS	R	Complete	610.AC8311	610.AC8311	600.BT23B	600.BT23G
2008	4X4	FIS	F	Complete	610.AC8145	610.AC8245	600.BT23B	600.BT23G
	4X4	FIS	R	Complete	610.AC8311	610.AC8311	600.BT23B	600.BT23G
	4X4	TRV	F	Complete	610.AC8145	610.AC8245	600.BT23B	600.BT23G
	4X4	TRV	R	Complete	610.AC8311	610.AC8311	600.BT23B	600.BT23G
2007	4X4	FIS	F	Complete	610.AC8145	610.AC8245	600.BT23B	600.BT23G
	4X4	FIS	R	Complete	610.AC8311	610.AC8311	600.BT23B	600.BT23G
2006	4X4	FIS	F	Complete	610.AC8145	610.AC8245	600.BT23B	600.BT23G
	4X4	FIS	R	Complete	610.AC8311	610.AC8311	600.BT23B	600.BT23G
	4X4	TBX	F	Complete	610.AC8245	610.AC8245	600.BT23B	600.BT23G
	4X4	TBX	R	Complete	610.AC8311	610.AC8311	600.BT23B	600.BT23G
	4X4	TRV	F	Complete	610.AC8245	610.AC8245	600.BT23B	600.BT23G
	4X4	TRV	R	Complete	610.AC8311	610.AC8311	600.BT23B	600.BT23G
2005	4X4	FIS	F	Complete	610.AC8110	610.AC8210	600.BT23A	600.BT23G
	4X4	FIS	R	Complete	610.AC8311	610.AC8311	600.BT23B	600.BT23G
	4X4	TBX	F	Complete	610.AC8110	610.AC8210	600.BT23A	600.BT23G
	4X4	TBX	R	Complete	610.AC8311	610.AC8311	600.BT23B	600.BT23G
	4X4	TRV	F	Complete	610.AC8210	610.AC8210	600.BT23A	600.BT23G
	4X4	TRV	R	Complete	610.AC8311	610.AC8311	600.BT23B	600.BT23G
2003-2004	4X4	FIS	F	Complete	610.AC8244	610.AC8244	600.BT23B	600.BT23G
	4X4	FIS	R	Complete	610.AC8244	610.AC8244	600.BT23B	600.BT23G
	4X4	TBX	F	Complete	610.AC8244	610.AC8244	600.BT23B	600.BT23G
	4X4	TBX	R	Complete	610.AC8244	610.AC8244	600.BT23B	600.BT23G
	4X4	TRV	F	Complete	610.AC8244	610.AC8244	600.BT23B	600.BT23G
	4X4	TRV	R	Complete	610.AC8244	610.AC8244	600.BT23B	600.BT23G
2002	4X4	FIS	F	Complete	610.AC8244	610.AC8244	600.BT23B	600.BT23G
	4X4	TBX	F	Complete	610.AC8305	610.AC8305	600.BT23A	600.BT4075G
2000-2001	4X4	A/T	F	Complete	610.AC8118	610.AC8218	600.BT23A	600.BT4075G
1998-2001	4X4	M/T	F	Complete	610.AC8218	610.AC8218	600.BT23A	600.BT4075G



ATV/UTV CV AXLES & BOOT KITS

Arctic Cat (continued)

Year(s)	DT	Model	Location	Type	Left Side CV	Right Side CV	Outboard CV Boot	Inboard CV Boot
550 (EXC. 550 / XT550 PROWLER)								
2009-2010	4X4	FIS	F	Complete	610.AC8145	610.AC8245	600.BT23B	600.BT23G
	4X4	FIS	R	Complete	610.AC8311	610.AC8311	600.BT23B	600.BT23G
	4X4	TRV	F	Complete	610.AC8145	610.AC8245	600.BT23B	600.BT23G
	4X4	TRV	R	Complete	610.AC8311	610.AC8311	600.BT23B	600.BT23G
550 / XT550 PROWLER								
2009-2010	4X4	550 / XT550	F	Complete	610.AC8147	610.AC8247	600.BT23C	600.BT23H
	4X4	550 / XT550	R	Complete	610.AC8316	610.AC8316	600.BT23C	600.BT23H
650 (EXC. 650H1 / XT650 PROWLER)								
2010	4X4	FIS	F	Complete	610.AC8145	610.AC8245	600.BT23B	600.BT23G
	4X4	FIS	R	Complete	610.AC8311	610.AC8311	600.BT23B	600.BT23G
2009	4X4	TBX	F	Complete	610.AC8145	610.AC8245	600.BT23B	600.BT23G
	4X4	TBX	R	Complete	610.AC8311	610.AC8311	600.BT23B	600.BT23G
	4X4	TRV	F	Complete	610.AC8145	610.AC8245	600.BT23B	600.BT23G
	4X4	TRV	R	Complete	610.AC8311	610.AC8311	600.BT23B	600.BT23G
2008	4X4	H1 FIS	F	Complete	610.AC8145	610.AC8245	600.BT23B	600.BT23G
	4X4	H1 FIS	R	Complete	610.AC8311	610.AC8311	600.BT23B	600.BT23G
	4X4	H1 TRV	F	Complete	610.AC8145	610.AC8245	600.BT23B	600.BT23G
	4X4	H1 TRV	R	Complete	610.AC8311	610.AC8311	600.BT23B	600.BT23G
2007	4X4	H1 FIS	F	Complete	610.AC8145	610.AC8245	600.BT23B	600.BT23G
	4X4	H1 FIS	R	Complete	610.AC8311	610.AC8311	600.BT23B	600.BT23G
	4X4	H1 TBX	F	Complete	610.AC8145	610.AC8245	600.BT23B	600.BT23G
	4X4	H1 TBX	R	Complete	610.AC8311	610.AC8311	600.BT23B	600.BT23G
	4X4	H1 TRV	F	Complete	610.AC8145	610.AC8245	600.BT23B	600.BT23G
	4X4	H1 TRV	R	Complete	610.AC8311	610.AC8311	600.BT23B	600.BT23G
2006	4X4	H1	F	Complete	610.AC8145	610.AC8245	600.BT23B	600.BT23G
	4X4	H1	R	Complete	610.AC8311	610.AC8311	600.BT23B	600.BT23G
	4X4	V2 FIS	F	Complete	610.AC8145	610.AC8245	600.BT23B	600.BT23G
	4X4	V2 FIS	R	Complete	610.AC8311	610.AC8311	600.BT23A	600.BT23G
2005	4X4	H1	F	Complete	610.AC8110	610.AC8210	600.BT23A	600.BT23G
	4X4	H1	R	Complete	610.AC8311	610.AC8311	600.BT23A	600.BT23G
	4X4	V2 FIS	F	Complete	610.AC8110	610.AC8210	600.BT23A	600.BT23G
	4X4	V2 FIS	R	Complete	610.AC8311	610.AC8311	600.BT23A	600.BT23G
2004	4X4	V2 FIS	F	Complete	610.AC8144	610.AC8244	600.BT23B	600.BT23G
	4X4	V2 FIS	R	Complete	610.AC8311	610.AC8311	600.BT23A	600.BT23G



ATV/UTV CV AXLES & BOOT KITS

Arctic Cat (continued)

Year(s)	DT	Model	Location	Type	Left Side CV	Right Side CV	Outboard CV Boot	Inboard CV Boot
650H1 / XT650 PROWLER								
2009	4X4	XT650 A/T	F	Complete	610.AC8147	610.AC8247	600.BT23C	600.BT23H
		XT650 A/T	R	Complete	610.AC8316	610.AC8316	600.BT23C	600.BT23H
2007-2008	4X4	650H1 A/T	F	Complete	610.AC8147	610.AC8247	600.BT23C	600.BT23H
		650H1 A/T	R	Complete	610.AC8316	610.AC8316	600.BT23C	600.BT23H
2006	4X4	XT650H1	F	Complete	610.AC8147	610.AC8247	600.BT23C	600.BT23H
		XT650H1	R	Complete	610.AC8316	610.AC8316	600.BT23C	600.BT23H
700 (EXC. XT700 / XTX700 PROWLER)								
2008-2010	4X4	H1 FIS	F	Complete	610.AC8145	610.AC8245	600.BT23B	600.BT23G
	4X4	H1 FIS	R	Complete	610.AC8311	610.AC8311	600.BT23A	600.BT23G
	4X4	TRV	F	Complete	610.AC8145	610.AC8245	600.BT23B	600.BT23G
	4X4	TRV	R	Complete	610.AC8311	610.AC8311	600.BT23A	600.BT23G
2006-2007	4X4	FIS	F	Complete	610.AC8145	610.AC8245	600.BT23B	600.BT23G
	4X4	FIS	R	Complete	610.AC8311	610.AC8311	600.BT23A	600.BT23G
XTZ1000 PROWLER								
2009-2010	4X4	1000XTZ	F	Complete	610.AC8247	610.AC8147	600.BT23C	600.BT23H
		1000XTZ	R	Complete	610.AC8316	610.AC8316	600.BT23C	600.BT23H
1000 (EXC. XTZ1000 PROWLER)								
2010	4X4	THUNDERCAT FIS	F	Complete	610.AC8145	610.AC8245	600.BT23B	600.BT23G
	4X4	THUNDERCAT FIS	R	Complete	610.AC8311	610.AC8311	600.BT23B	600.BT23G
	4X4	TRV	F	Complete	610.AC8145	610.AC8245	600.BT23B	600.BT23G
	4X4	TRV	R	Complete	610.AC8311	610.AC8311	600.BT23B	600.BT23G
	4X4	MUD PRO	F	Complete	610.AC8145	610.AC8245	600.BT23B	600.BT23G
	4X4	MUD PRO	R	Complete	610.AC8311	610.AC8311	600.BT23B	600.BT23G
2009	4X4	THUNDERCAT FIS	F	Complete	610.AC8145	610.AC8245	600.BT23B	600.BT23G
	4X4	THUNDERCAT FIS	R	Complete	610.AC8311	610.AC8311	600.BT23B	600.BT23G
	4X4	TRV	F	Complete	610.AC8145	610.AC8245	600.BT23B	600.BT23G
	4X4	TRV	R	Complete	610.AC8311	610.AC8311	600.BT23B	600.BT23G
2008	4X4	THUNDERCAT FIS	F	Complete	610.AC8145	610.AC8245	600.BT23B	600.BT23G
	4X4	THUNDERCAT FIS	R	Complete	610.AC8311	610.AC8311	600.BT23B	600.BT23G



ATV/UTV CV AXLES & BOOT KITS

Can Am

Year(s)	DT	Model	Location	Type	Left Side CV	Right Side CV	Outboard CV Boot	Inboard CV Boot
OUTLANDER 400								
2007-2012	4X4	400 EFI / STD / XT	F	Complete	610.CA8111	610.CA8211	600.BT2411E	600.BT2069P
2006	4X4	400 STD / XT	F	Complete	N/A	610.CA8211	600.BT2411E	600.BT2069P
OUTLANDER MAX 400								
2007-2012	4X4	400 EFI / STD / XT	F	Complete	610.CA8111	610.CA8211	600.BT2411E	600.BT2069P
2006	4X4	400 STD / XT	F	Complete	N/A	610.CA8211	600.BT2411E	600.BT2069P
OUTLANDER 500								
2008-2012	4X4	500 EFI / STD / XT	F	Complete	610.CA8111	610.CA8211	600.BT2411E	600.BT2069P
	4X4	500 EFI / STD / XT	R	Complete	610.CA8301	610.CA8302	600.BT3082A	600.BT3082G
2007	4X4	500 STD	F	Complete	610.CA8111	610.CA8211	600.BT2411E	600.BT2069P
	4X4	500 STD	R	Complete	610.CA8326	610.CA8327		
OUTLANDER MAX 500								
2008-2012	4X4	500 EFI / LTD / STD / XT	F	Complete	610.CA8111	610.CA8211	600.BT2411E	600.BT2069P
	4X4	500 EFI / LTD / STD / XT	R	Complete	610.CA8301	610.CA8302	600.BT3082A	600.BT3082G
2007	4X4	500 STD / XT	F	Complete	610.CA8111	610.CA8211	600.BT2411E	600.BT2069P
	4X4	500 STD / XT	R	Complete	610.CA8326	610.CA8327		
RENEGADE 500								
2010	4X4	500 EFI	F	Complete	610.CA8111	610.CA8211	600.BT2411E	600.BT2069P
2008-2009	4X4	500	F	Complete	610.CA8111	610.CA8211	600.BT2411E	600.BT2069P
OUTLANDER 650								
2012	4X4	650 EFI / STD / XT	F	Complete	610.CA8111	610.CA8211	600.BT2411E	600.BT2069P
	4X4	650 EFI / STD / XT	R	Complete	610.CA8301	610.CA8302	600.BT3082A	600.BT3082G
2010-2011	4X4	650 EFI	F	Complete	610.CA8111	610.CA8211	600.BT2411E	600.BT2069P
	4X4	650 EFI	R	Complete	610.CA8301	610.CA8302	600.BT3082A	600.BT3082G
2009	4X4	650 EFI / XT	F	Complete	610.CA8111	610.CA8211	600.BT2411E	600.BT2069P
	4X4	650 EFI / XT	R	Complete	610.CA8301	610.CA8302	600.BT3082A	600.BT3082G
2008	4X4	650 STD / XT	F	Complete	610.CA8111	610.CA8211	600.BT2411E	600.BT2069P
	4X4	650 STD / XT	R	Complete	610.CA8301	610.CA8302	600.BT3082A	600.BT3082G
2007	4X4	STD / XT	F	Complete	610.CA8111	610.CA8211	600.BT2411E	600.BT2069P
	4X4	STD / XT	R	Complete	610.CA8326	610.CA8327		
2006	4X4	STD / XT	R	Complete	610.CA8326	610.CA8327		



ATV/UTV CV AXLES & BOOT KITS

Can Am (continued)

Year(s)	DT	Model	Location	Type	Left Side CV	Right Side CV	Outboard CV Boot	Inboard CV Boot
OUTLANDER MAX 650								
2012	4X4	650 EFI / XT / XTP	F	Complete	610.CA8111	610.CA8211	600.BT2411E	600.BT2069P
	4X4	650 EFI / XT / XTP	R	Complete	610.CA8301	610.CA8302	600.BT3082A	600.BT3082G
2010-2011	4X4	650 EFI	F	Complete	610.CA8111	610.CA8211	600.BT2411E	600.BT2069P
	4X4	650 EFI	R	Complete	610.CA8301	610.CA8302	600.BT3082A	600.BT3082G
2009	4X4	650 EFI / XT	F	Complete	610.CA8111	610.CA8211	600.BT2411E	600.BT2069P
	4X4	650 EFI / XT	R	Complete	610.CA8301	610.CA8302	600.BT3082A	600.BT3082G
2008	4X4	650 STD / XT	F	Complete	610.CA8111	610.CA8211	600.BT2411E	600.BT2069P
	4X4	650 STD / XT	R	Complete	610.CA8301	610.CA8302	600.BT3082A	600.BT3082G
2007	4X4	650 STD / XT	F	Complete	610.CA8111	610.CA8211	600.BT2411E	600.BT2069P
	4X4	650 STD / XT	R	Complete	610.CA8326	610.CA8327		
2006	4x4	650 STD / XT	R	Complete	610.CA8326	610.CA8327		
COMMANDER 800								
2012	4X4	800R EFI / STD / XT	F	Complete	610.CA8113	610.CA8213	600.BT2411E	600.BT2069P
	4X4	800R EFI / STD / XT	R	Complete	610.CA8306	610.CA8306	600.BT3082A	600.BT3082G
2011	4X4	800	F	Complete	610.CA8113	610.CA8213	600.BT2411E	600.BT2069P
OUTLANDER 800								
2012	4X4	800R EFI / STD / XT (EXC: XMR)	F	Complete	610.CA8112	610.CA8212	600.BT2411E	600.BT2069P
	4X4	800R EFI / STD / XT / XMR	R	Complete	610.CA8301	610.CA8302	600.BT3082A	600.BT3082G
2011	4X4	800R EFI (EXC: XMR / XXC)	F	Complete	610.CA8111	610.CA8211	600.BT2411E	600.BT2069P
	4X4	800R EFI / XMR / XXC	R	Complete	610.CA8301	610.CA8302	600.BT3082A	600.BT3082G
2010	4X4	800R EFI	F	Complete	610.CA8111	610.CA8211	600.BT2411E	600.BT2069P
	4X4	800R EFI	R	Complete	610.CA8301	610.CA8302	600.BT3082A	600.BT3082G
2009	4X4	800R EFI / XT	F	Complete	610.CA8111	610.CA8211	600.BT2411E	600.BT2069P
	4X4	800R EFI / XT	R	Complete	610.CA8301	610.CA8302	600.BT3082A	600.BT3082G
2008	4X4	800 STD / XT	F	Complete	610.CA8111	610.CA8211	600.BT2411E	600.BT2069P
	4X4	800 STD / XT	R	Complete	610.CA8301	610.CA8302	600.BT3082A	600.BT3082G
2007	4X4	800 STD / XT	F	Complete	610.CA8111	610.CA8211	600.BT2411E	600.BT2069P
	4X4	800 STD / XT	R	Complete	610.CA8326	610.CA8327		
2006	4X4	800 STD / XT	R	Complete	610.CA8326	610.CA8327		



ATV/UTV CV AXLES & BOOT KITS

Can Am (continued)

Year(s)	DT	Model	Location	Type	Left Side CV	Right Side CV	Outboard CV Boot	Inboard CV Boot
OUTLANDER MAX 800R								
2012	4X4	800R EFI / STD / XT / XTP	F	Complete	610.CA8111	610.CA8211	600.BT2411E	600.BT2069P
	4X4	800R EFI / STD / XT / XTP	R	Complete	610.CA8301	610.CA8302	600.BT3082A	600.BT3082G
2010-2011	4X4	800R EFI / LTD	F	Complete	610.CA8111	610.CA8211	600.BT2411E	600.BT2069P
	4X4	800R EFI / LTD	R	Complete	610.CA8301	610.CA8302	600.BT3082A	600.BT3082G
2009	4X4	800R EFI / LTD / XT	F	Complete	610.CA8111	610.CA8211	600.BT2411E	600.BT2069P
	4X4	800R EFI / LTD / XT	R	Complete	610.CA8301	610.CA8302	600.BT3082A	600.BT3082G
2008	4X4	800 STD / LTD / XT	F	Complete	610.CA8111	610.CA8211	600.BT2411E	600.BT2069P
	4X4	800 STD / LTD / XT	R	Complete	610.CA8301	610.CA8302	600.BT3082A	600.BT3082G
2007	4X4	800 STD / LTD / XT	F	Complete	610.CA8111	610.CA8211	600.BT2411E	600.BT2069P
	4X4	800 STD / LTD / XT	R	Complete	610.CA8326	610.CA8327		
2006	4X4	800 STD / LTD / XT	R	Complete	610.CA8326	610.CA8327		
RENEGADE 800								
2012	4X4	800R STD / XXC	F	Complete	610.CA8112	610.CA8212	600.BT2411E	600.BT2069P
	4X4	800R STD / XXC	R	Complete	610.CA8301	610.CA8302	600.BT3082A	600.BT3082G
2011	4x4	800R EFI / XXC	R	Complete	610.CA8301	610.CA8302	600.BT3082A	600.BT3082G
2010	4X4	800R EFI / STD / XXC	F	Complete	610.CA8111	610.CA8211	600.BT2411E	600.BT2069P
	4X4	800R EFI / STD / XXC	R	Complete	610.CA8301	610.CA8302	600.BT3082A	600.BT3082G
2009	4X4	800R EFI / STD / X	F	Complete	610.CA8111	610.CA8211	600.BT2411E	600.BT2069P
	4X4	800R EFI / STD / X	R	Complete	610.CA8301	610.CA8302	600.BT3082A	600.BT3082G
2008	4X4	800 / X	F	Complete	610.CA8111	610.CA8211	600.BT2411E	600.BT2069P
	4X4	800 / X	R	Complete	610.CA8301	610.CA8302	600.BT3082A	600.BT3082G
2007	4X4	800 EFI	F	Complete	610.CA8111	610.CA8211	600.BT2411E	600.BT2069P
	4X4	800 EFI	R	Complete	610.CA8326	610.CA8327		
COMMANDER 1000								
2012	4X4	1000 EFI / STD / LTD / X / XT	F	Complete	610.CA8113	610.CA8213	600.BT2411E	600.BT2069P
	4X4	1000 EFI / STD / LTD / X / XT	R	Complete	610.CA8306	610.CA8306	600.BT3082A	600.BT3082G
2011	4X4	1000	F	Complete	610.CA8113	610.CA8213	600.BT2411E	600.BT2069P
OUTLANDER 1000								
2013-2014	4X4	Outlander 1000 705401115 / 1116	F	Complete	610.CA8115	610.CA8215		
	4X4	Outlander 1000 705501485 / 1486	R	Complete	610.CA8304	610.CA8305		
	4X4	Outlander 1000 XMR	F	Complete	610.CA8116	610.CA8216		
2012	4X4	1000 EFI / STD / XT	F	Complete	610.CA8112	610.CA8212	600.BT2411E	600.BT2069P
	4X4	1000 EFI / STD / XT	R	Complete	610.CA8301	610.CA8302	600.BT3082A	600.BT3082G
RENEGADE 1000								
2013-2014	4X4	Renegade 1000 705401115 / 1116	F	Complete	610.CA8115	610.CA8215		
	4X4	Renegade 1000 705501485 / 1486	R	Complete	610.CA8304	610.CA8305		
2012	4X4	1000 STD / XXC	F	Complete	610.CA8112	610.CA8212	600.BT2411E	600.BT2069P
	4X4	1000 STD / XXC	R	Complete	610.CA8301	610.CA8302	600.BT3082A	600.BT3082G



ATV/UTV CV AXLES & BOOT KITS

Honda

Year(s)	DT	Model	Location	Type	Left Side CV	Right Side CV	Outboard CV Boot	Inboard CV Boot
TRX300								
1993-2000	4X4	FOURTRAX	F	HalfShaft	610.H07303	610.H07303	600.BT702A	600.BT701G
TRX350								
2000-2005	4X4	RANCHER	F	Complete	610.H08306	610.H08306	600.BT702A	600.BT701G
TRX400								
2004-2007	4X4	RANCHER	F	Complete	610.H08302	610.H08302	600.BT702A	600.BT701G
1995-2001	4X4	FOREMAN	F	Complete	610.H08101	610.H08201	600.BT702A	600.BT701G
TRX420								
2013	4X4	TRX420FA AC / FA 2AC	F	Complete	610.H08120	610.H08220	600.BT702A	600.BT701H
	4X4	TRX420FA AC / FA 2AC	R	Complete	610.H08321	610.H08322		
		TRX420FE AC / FE 2AC	F	Complete	610.H08120	610.H08220	600.BT702A	600.BT701H
	4X4	TRX420FM AC / FM 2AC	F	Complete	610.H08120	610.H08220	600.BT702A	600.BT701H
	4X4	TRX420FPA AC / FPA 2AC	F	Complete	610.H08120	610.H08220	600.BT702A	600.BT701H
	4X4	TRX420FPA AC / FPA 2AC	R	Complete	610.H08321	610.H08322		
	4X4	TRX420FPE AC / FPE 2AC	F	Complete	610.H08120	610.H08220	600.BT702A	600.BT701H
	4X4	TRX420FPM AC / FPM 2AC	F	Complete	610.H08120	610.H08220	600.BT702A	600.BT701H
2010-2012	4X4	TRX420FA A / FA 2A	F	Complete	610.H08120	610.H08220	600.BT702A	600.BT701H
	4X4	TRX420FA A / FA 2A	R	Complete	610.H08321	610.H08322		
	4X4	TRX420FE A / FE 2A / FM A / FM 2A	F	Complete	610.H08120	610.H08220	600.BT702A	600.BT701H
	4X4	TRX420FPA A / FPA 2A	F	Complete	610.H08120	610.H08220	600.BT702A	600.BT701H
	4X4	TRX420FPA A / FPA 2A	R	Complete	610.H08321	610.H08322		
	4X4	TRX420FPE A / FPE 2A	F	Complete	610.H08120	610.H08220	600.BT702A	600.BT701H
	4X4	TRX420FPM A / FPM 2A	F	Complete	610.H08120	610.H08220	600.BT702A	600.BT701H
2009	4X4	TRX420FA A / FA 2A	F	Complete	610.H08119	610.H08219	600.BT702A	600.BT701H
	4X4	TRX420FA A / FA 2A	R	Complete	610.H08321	610.H08322		
	4X4	TRX420FE A / FE 2A / FM A / FM 2A	F	Complete	610.H08119	610.H08219	600.BT702A	600.BT701H
	4X4	TRX420FPA A / FPA 2A	F	Complete	610.H08120	610.H08220	600.BT702A	600.BT701H
	4X4	TRX420FPA A / FPA 2A	R	Complete	610.H08321	610.H08322		
	4X4	TRX420FPE A / FPE 2A	F	Complete	610.H08120	610.H08220	600.BT702A	600.BT701H
	4X4	TRX420FPM A / FPM 2A	F	Complete	610.H08120	610.H08220	600.BT702A	600.BT701H
2007-2008	4X4	TRX420 RANCHER ALL	F	Complete	610.H08119	610.H08219	600.BT702A	600.BT701H
TRX450								
1999-2004	4X4	FOREMAN	F	Complete	610.H08108	610.H08208	600.BT702A	600.BT701G



ATV/UTV CV AXLES & BOOT KITS

Honda (continued)

Year(s)	DT	Model	Location	Type	Left Side CV	Right Side CV	Outboard CV Boot	Inboard CV Boot
TRX500								
2011-2012	4X4	TRX500FA / FPA	F	Complete	610.H08117	610.H08217	600.BT2047A	600.BT701H
	4X4	TRX500FE / FM / FPE / FPM	F	Complete	610.H08117	610.H08217	600.BT2047A	600.BT701H
2009	4X4	TRX500FM / FE / FPA / FPM / FPE	F	Complete	610.H08118	610.H08218	600.BT702A	600.BT701H
2008	4X4	TRX500FA / FE / FM / FPE / FPM	F	Complete	610.H08118	610.H08218	600.BT702A	600.BT701H
2005-2007	4X4	FOREMAN	F	Complete	610.H08117	610.H08217	600.BT2047A	600.BT701H
	4X4	RUBICON	F	Complete	610.H08117	610.H08217	600.BT2047A	600.BT701H
	4X4	FOREMAN FPE 2A/A	F	Complete	610.H08118	610.H08218	600.BT702A	600.BT701H
2001-2004	4X4	RUBICON	F	Complete	610.H08107	610.H08207	600.BT2047A	600.BT701G
TRX650								
2005-2006	4X4	RINCON	F	Complete	610.H08117	610.H08217	600.BT2047A	600.BT701H
	4X4	RINCON	R	Complete	610.H08301	610.H08301	600.BT4075A	600.BT190G
2003-2004	4X4	RINCON	F	Complete	610.H08116	610.H08216	600.BT2047A	600.BT701H
	4X4	RINCON	R	Complete	610.H08301	610.H08301	600.BT4075A	600.BT190G
TRX680								
2010-2012	4X4	TRX680FA	F	Complete	610.H08117	610.H08217	600.BT2047A	600.BT701H
	4X4	TRX680FA	R	Complete	610.H08301	610.H08301	600.BT4075A	600.BT190G
2008-2009	4X4	TRX680FA	F	Complete	610.H08118	610.H08218	600.BT702A	600.BT701H
	4X4	TRX680FA	R	Complete	610.H08301	610.H08301	600.BT4075A	600.BT190G
2006-2007	4X4	RINCON	F	Complete	610.H08117	610.H08217	600.BT2047A	600.BT701H
	4X4	RINCON	R	Complete	610.H08301	610.H08301	600.BT4075A	600.BT190G

Kawasaki

Year(s)	DT	Model	Location	Type	Left Side CV	Right Side CV	Outboard CV Boot	Inboard CV Boot
300 BAYOU								
1989-2005	4X4	KLF300	F	Complete	610.KW8308	610.KW8308	600.BT702A	600.BT701G
300 PRAIRIE								
1999-2002	4X4	KVF300	F	Complete	610.KW8304	610.KW8304	600.BT702A	600.BT702G
360 PRAIRIE								
2003-2012	4X4	KVF360	F	Complete	610.KW8105	610.KW8205	600.BT702A	600.BT701H
400 BAYOU								
1993-1999	4X4	KLF400	F	Complete	610.KW8308	610.KW8308	600.BT702A	600.BT701G



ATV/UTV CV AXLES & BOOT KITS

Kawasaki (continued)

Year(s)	DT	Model	Location	Type	Left Side CV	Right Side CV	Outboard CV Boot	Inboard CV Boot
400 PRAIRIE								
1997-2002	4X4	KVF400	F	Complete	610.KW8300	610.KW8300	600.BT702A	600.BT2069G
610 MULE								
2012-2013	4X4	KAF400ADF	F	Complete	610.KW8303	610.KW8303	600.BT2411C	600.BT701H
	4X4	KAF400DDFXC	F	Complete	610.KW8303	610.KW8303	600.BT2411C	600.BT701H
2007 EARLIER	4X4	KAF400	F	Complete	610.KW8303	610.KW8303	600.BT2411C	600.BT701H
650 BRUTE FORCE								
2005-2013	4X4	KVF650DDF	F	Complete	610.KW8105	610.KW8205	600.BT702A	600.BT701H
650 PRAIRIE								
2002-2003	4X4	KVF650	F	Complete	610.KW8105	610.KW8205	600.BT702A	600.BT701H
650i BRUTE FORCE								
2006-2013	4X4	KVF650FDF	F	Complete	610.KW8124	610.KW8224	600.BT2047A	600.BT701H
	4X4	KVF650FDF	R	Complete	610.KW8312	610.KW8312	600.BT180A	600.BT702H
700 PRAIRIE								
2004-2006	4X4	KVF700	F	Complete	610.KW8105	610.KW8205	600.BT702A	600.BT701H
750 TERYX								
2008-2011	4X4	KRF750	F	Complete	610.KW8301	610.KW8301	600.BT2047A	600.BT701H
	4X4	KRF750	R	Complete	610.KW8318	610.KW8319	600.BT7879A	600.BT2095G
750i BRUTE FORCE								
2012-2013	4X4	KVF750	F	Complete	610.KW8124	610.KW8224	600.BT2047A	600.BT701H
	4X4	KVF750	R	Complete	610.KW8312	610.KW8312	600.BT180A	600.BT702H
2008-2011	4X4	KVF750D	F	Complete	610.KW8121	610.KW8221	600.BT190A	600.BT2069M
	4X4	KVF750D	R	Complete	610.KW8312	610.KW8312	600.BT180A	600.BT702H
2005-2007	4X4i	KVF750	F	Complete	610.KW8124	610.KW8224	600.BT2047A	600.BT701H
	4X4i	KVF750	R	Complete	610.KW8312	610.KW8312	600.BT180A	600.BT702H
2510 MULE								
2000-2002	4X4	KAF620/KAF950 DIESEL	F	Complete	610.KW8305	610.KW8305	600.BT2069C	600.BT701H
3010 MULE								
2001-2008	4X4	KAF620/KAF950 DIESEL	F	Complete	610.KW8305	610.KW8305	600.BT2069C	600.BT701H
4010 MULE								
2009-2013	4X4	KAF950 (DIESEL)	F	Complete	610.KW8305	610.KW8305	600.BT2069C	600.BT701H
2009-2012	4X4	KAF620MCF	F	Complete	610.KW8305	610.KW8305	600.BT2069C	600.BT701H

Kubota

Year(s)	DT	Model	Location	Type	Left Side CV	Right Side CV
RTV900/1100/1140						
2004-2011	4X4	RTV900/1100/1140 (EARLY) ROUND IBJ K7561-15310	F	Complete	610.KU8301	610.KU8301
2009-2014	4X4	RTV900/1100/1140 (LATE) TRIPOD IBJ K7581-15310	F	Complete	610.KU8302	610.KU8302

ATV/UTV CV AXLES & BOOT KITS



Polaris

Year(s)	DT	Model	Location	Type	Left Side CV	Right Side CV	Outboard CV Boot	Inboard CV Boot
250 XPLORER								
2000-2002	4X4	W00AG/W01AG/ W02CG - 25CA	F	Complete	610.P08322	610.P08322	600.BT2343A	N/A
300 HAWKEYE								
2008-2010	2X4	A10/ 8 / 9LB27AA	R	Complete	610.P08341	610.P08341	600.BT2069B	600.BT2069B
2006- 2007	4X4	A07LB27AA/AC/ A07LH27AA/AB/AC/ AD/AL	F	Complete	610.P08315	610.P08315	600.BT2069B	600.BT2069B
	4X4	A07LB27AA/AC/ A07LH27AA/AB/AC/ AD/AL	R	Complete	610.P08341	610.P08341	600.BT2069B	600.BT2069B
	4X4	A07LB27FA/ A07LH27FB (International)	F	Complete	610.P08315	610.P08315	600.BT2069B	600.BT2069B
	4X4	A07LB27FA/ A07LH27FB (International)	R	Complete	610.P08341	610.P08341	600.BT2069B	600.BT2069B
	2X4	A07LB27AA/AC/ A07LH27AA/AB/AC/ AD/AL	R	Complete	610.P08341	610.P08341	600.BT2069B	600.BT2069B
	2X4	A07LB27FA/ A07LH27FB (International)	R	Complete	610.P08341	610.P08341	600.BT2069B	600.BT2069B
300 SPORTSMAN								
2008-2010	4X4	A10/ 9 / 8LH27AX/AZ	F	Complete	610.P08315	610.P08315	600.BT2069B	600.BT2069B
	4X4	A10LH27AX/AZ	R	Complete	610.P08341	610.P08341	600.BT2069B	600.BT2069B
300 XPLORER								
1996-1999	4X4	W969130/W97CC/ W98CC/W99CC - 28C/28CA	F	Complete	610.P08324	610.P08324	600.BT2411A	N/A
325 MAGNUM								
2002	4X4	A02CD32AA/AB/AC W/O Visco Lok LSD	F	Complete	610.P08324	610.P08324	600.BT2411A	N/A
2001	4X4	A01CD32AA W/O Visco Lok LSD	F	Complete	610.P08324	610.P08324	600.BT2411A	N/A
2000	4X4	A00CD32AA/FB	F	Complete	610.P08324	610.P08324	600.BT2411A	N/A
325 XPEDITION								
2000-2002	4X4	A00CK/A01CK/A02CK - 32AA	F	Complete	610.P08324	610.P08324	600.BT2411A	N/A
330 ATP								



ATV/UTV CV AXLES & BOOT KITS

Polaris (continued)

Year(s)	DT	Model	Location	Type	Left Side CV	Right Side CV	Outboard CV Boot	Inboard CV Boot
335 SPORTSMAN								
2000	4X4	A00CH33AA/AB/AD/AE/AF/AG (BTB) on housing	F	Complete	610.P08324	610.P08324	600.BT2411A	N/A
	4X4	A00CH33AA/AB/AD/AE/AF/AG With CV Joint	R	Complete	610.P08302	610.P08302	600.BT4087A	N/A
1999	4X4	A99CH33AA/AB/CB Stamped (BTB) on housing	F	Complete	610.P08324	610.P08324	600.BT2411A	N/A
335 WORKER								
1999	4X4	A99CH33IA/EB Stamped (BTB) on housing	F	Complete	610.P08324	610.P08324	600.BT2411A	N/A
400 HAWKEYE HO								
2011-2013	2X4	A13 / 12 / 11MB46FZ	R	Complete	610.P08329	610.P08329		
400 RANGER								
2013	4X4	R13RH45AG MIDSIZE	F	Complete	610.P08314	610.P08314		
	4X4	R13RH45AG MIDSIZE	R	Complete	610.P08343	610.P08343		
2012	4X4	R12RH45AG/AH/AR	F	Complete	610.P08314	610.P08314		
	4X4	R12RH45AG/AH/AR	R	Complete	610.P08343	610.P08343		
2010-2011	4X4	R11 / 10RH45AG/AH/AR (400 HO)	F	Complete	610.P08314	610.P08314		
	4X4	R11 / 10RH45AG/AH/AR (400 HO)	R	Complete	610.P08343	610.P08343		
400 SCRAMBLER								
2001-2002	4X4	A01BG/A02BG - 38CA	F	Complete	610.P08322	610.P08322	600.BT2343A	N/A
2000	4X4	A00BG38CA Stamped (USA) on housing	F	Complete	610.P08322	610.P08322	600.BT2343A	N/A
1999	4X4	A99BG38CA Stamped (BTB) on housing	F	Complete	610.P08324	610.P08324	600.BT2411A	N/A
	4X4	A99BG38CB Stamped (USA) on housing	F	Complete	610.P08322	610.P08322	600.BT2343A	N/A
1997-1998	4X4	W98BC38C Stamped (BTB) on housing	F	Complete	610.P08324	610.P08324	600.BT2411A	N/A
1995-1996	4X4	W967840 Stamped (BTB) on housing	F	Complete	610.P08324	610.P08324	600.BT2411A	N/A
	4X4	W967840 Stamped (USA) on housing	F	Complete	610.P08322	610.P08322	600.BT2343A	N/A

ATV/UTV CV AXLES & BOOT KITS



Polaris (continued)

Year(s)	DT	Model	Location	Type	Left Side CV	Right Side CV	Outboard CV Boot	Inboard CV Boot
400 SPORTSMAN								
2005	4X4	A05MH42AB/AG/AH	F	Complete	610.P08305	610.P08305	600.BT2343A	600.BT2411G
	4X4	A05MH42AB/AG/AH	R	Complete	610.P08301	610.P08301	600.BT4087A	600.BT4087G
2004	4X4	A04CH42AQ/AV Male Inboard Spline Yoke	F	Complete	610.P08303	610.P08303	600.BT2343A	N/A
	4X4	A04CH42AA/AE/AG	R	Complete	610.P08301	610.P08301	600.BT4087A	600.BT4087G
2003	4X4	A03CH42AA/AB/AC	F	Complete	610.P08322	610.P08322	600.BT2343A	N/A
	4X4	A03CH42AA/AB/AC	R	Complete	610.P08301	610.P08301	600.BT4087A	600.BT4087G
2002	4X4	A02CH42AA/AB	F	Complete	610.P08322	610.P08322	600.BT2343A	N/A
	4X4	A02CH42AA	R	Complete	610.P08302	610.P08302	600.BT4087A	600.BT4087G
2001	4X4	A01CH42AA	F	Complete	610.P08324	610.P08324	600.BT2411A	N/A
	4X4	A01CH42AA	R	Complete	610.P08302	610.P08302	600.BT4087A	600.BT4087G
1997	4X4	W97AC38C Stamped (BTB) on housing	F	Complete	610.P08324	610.P08324	600.BT2411A	N/A
1995-1996	4X4	W967840 Stamped (BTB) on housing	F	Complete	610.P08324	610.P08324	600.BT2411A	N/A
	4X4	W967840 Stamped (USA) on housing	F	Complete	610.P08322	610.P08322	600.BT2343A	N/A
400 SPORTSMAN HO								
2013-2014	4X4	Sportsman 400HO 1332931	F	Complete	610.P08321	610.P08321		
2013	4X4	A13MH46AF/AX	R	Complete	610.P08329	610.P08329		
2012	4X4	A12MH46AF/AX/AZ	F	Complete	610.P08319	610.P08319		
	4X4	A12MH46AF/AX/AZ	R	Complete	610.P08329	610.P08329		
2011	4X4	A11MH46AX/AZ	F	Complete	610.P08319	610.P08319		
	4X4	A11MH46AX/AZ	R	Complete	610.P08329	610.P08329		
2010	4X4	A10LH46AX/AZ	F	Complete	610.P08315	610.P08315	600.BT2069B	600.BT2069B
	4X4	A10LH46AX/AZ	R	Complete	610.P08341	610.P08341	600.BT2069B	600.BT2069B
2008-2009	4X4	A09LH46AQ/AX/AZ	F	Complete	610.P08315	610.P08315	600.BT2069B	600.BT2069B
	4X4	A09LH46AQ/AX/AZ	R	Complete	610.P08341	610.P08341	600.BT2069B	600.BT2069B
400 XPLORER								
1999-2002	4X4	A99CG/00CG/01CG/02CG - 38CA	F	Complete	610.P08322	610.P08322	600.BT2343A	N/A
1998	4X4	A98CC38C Stamped (BTB) on housing	F	Complete	610.P08324	610.P08324	600.BT2411A	N/A
1997	4X4	W97CC38C	F	Complete	610.P08324	610.P08324	600.BT2411A	N/A
1995-1996	4X4	W969140 Stamped (BTB) on housing	F	Complete	610.P08324	610.P08324	600.BT2411A	N/A
	4X4	W969140 Stamped (USA) on housing	F	Complete	610.P08322	610.P08322	600.BT2343A	N/A



ATV/UTV CV AXLES & BOOT KITS

Polaris (continued)

Year(s)	DT	Model	Location	Type	Left Side CV	Right Side CV	Outboard CV Boot	Inboard CV Boot
400L BIG BOSS								
1997	6X6	N97AE38A/W97AE38D	F	Complete	610.P08324	610.P08324	600.BT2411A	N/A
1995-1996	6X6	N968740 Stamped (BTB) on housing	F	Complete	610.P08324	610.P08324	600.BT2411A	N/A
	6X6	W968740 Stamped (BTB) on housing	F	Complete	610.P08324	610.P08324	600.BT2411A	N/A
425 MAGNUM								
1998	4X4	N98AC42D	F	Complete	610.P08324	610.P08324	600.BT2411A	N/A
	4X4	S98AC42E	F	Complete	610.P08324	610.P08324	600.BT2411A	N/A
	4X4	W98AC42A	F	Complete	610.P08324	610.P08324	600.BT2411A	N/A
1997	6X6	S97AE42E (Sweden)	F	Complete	610.P08324	610.P08324	600.BT2411A	N/A
	6X6	W97AE42A	F	Complete	610.P08324	610.P08324	600.BT2411A	N/A
	4X4	S97AC42E (Sweden)	F	Complete	610.P08324	610.P08324	600.BT2411A	N/A
1996	4X4	W97AC42A	F	Complete	610.P08324	610.P08324	600.BT2411A	N/A
	6X6	S968744 (Sweden) Stamped (BTB) on housing	F	Complete	610.P08324	610.P08324	600.BT2411A	N/A
	6X6	S968744 (Sweden) Stamped (USA) on housing	F	Complete	610.P08322	610.P08322	600.BT2343A	N/A
1996	6X6	W968744 Stamped (BTB) on housing	F	Complete	610.P08324	610.P08324	600.BT2411A	N/A
	6X6	W968744 Stamped (USA) on housing	F	Complete	610.P08322	610.P08322	600.BT2343A	N/A
	4X4	S968144 (Sweden) Stamped (BTB) on housing	F	Complete	610.P08324	610.P08324	600.BT2411A	N/A
1996	4X4	S968144 (Sweden) Stamped (USA) on housing	F	Complete	610.P08322	610.P08322	600.BT2343A	N/A
	4X4	W968144 Stamped (BTB) on housing	F	Complete	610.P08324	610.P08324	600.BT2411A	N/A
	4X4	W968144 Stamped (USA) on housing	F	Complete	610.P08322	610.P08322	600.BT2343A	N/A
1995	4X4	S&N958144 (International) Stamped (BTB)	F	Complete	610.P08324	610.P08324	600.BT2411A	N/A
	4X4	S&N958144 (International) Stamped (USA)	F	Complete	610.P08322	610.P08322	600.BT2343A	N/A
	4X4	W958144 Stamped (BTB) on housing	F	Complete	610.P08324	610.P08324	600.BT2411A	N/A
1995	4X4	W958144 Stamped (USA) on housing	F	Complete	610.P08322	610.P08322	600.BT2343A	N/A



ATV/UTV CV AXLES & BOOT KITS

Polaris (continued)

Year(s)	DT	Model	Location	Type	Left Side CV	Right Side CV	Outboard CV Boot	Inboard CV Boot
425 XPEDITION								
2002	4X4	A02CK42AA/AB	F	Complete	610.P08322	610.P08322	600.BT2343A	N/A
2000-2001	4X4	A00CK/A01CK - 42AA	F	Complete	610.P08324	610.P08324	600.BT2411A	N/A
450 SPORTSMAN								
2007	4X4	A07MH46AA/AZMfg. Before 7/25/08	F	Complete	610.P08317	610.P08317	600.BT2411B	600.BT190H
	4X4	A07MH46AA/AZMfg. After 7/25/06	F	Complete	610.P08319	610.P08319		
	4X4	A07MH46AA/AZ	R	Complete	610.P08354	610.P08354	600.BT3082A	600.BT3082G
2006	4X4	A06MH46AA	F	Complete	610.P08316	610.P08316		
	4X4	A06MH46AA	R	Complete	610.P08354	610.P08354	600.BT3082A	600.BT3082G
500 ATP								
2004	4X4	A04JD50AA/AB/CA	F	Complete	610.P08303	610.P08303	600.BT2343A	N/A
500 BIG BOSS								
2002	6X6	A02CL50AA/DA (International)	F	Complete	610.P08322	610.P08322	600.BT2343A	N/A
2001	6X6	A01CL50AA (International) Stamped (BTB)	F	Complete	610.P08324	610.P08324	600.BT2411A	N/A
1999-2000	6X6	A00CL50AA/DA (International)	F	Complete	610.P08324	610.P08324	600.BT2411A	N/A
1998	6X6	N98AE50D / S98AE50E (International)	F	Complete	610.P08324	610.P08324	600.BT2411A	N/A
500 MAGNUM								
2002	2X4	A02CB50FC	F	Complete	610.P08322	610.P08322	600.BT2343A	N/A
2001	4X4	A01CD50AA Stamped (BTB) W/O Visco Lok	F	Complete	610.P08324	610.P08324	600.BT2411A	N/A
1999-2000	4X4	A00CD50AA Stamped (BTB) on housing	F	Complete	610.P08324	610.P08324	600.BT2411A	N/A
500 PPS								
2002	6X6	C02CL50AB LUH	F	Complete	610.P08322	610.P08322	600.BT2343A	N/A
500 RANGER								
2013	4X4	R13RH50AG/AH/AM/AR MIDSIZE	F	Complete	610.P08314	610.P08314		
	4X4	R13RH50AG/AH/AM/ AR MIDSIZE	R	Complete	610.P08343	610.P08343		
2011-2013	4X4	R13WH50AG/AH/AR/ AX MIDSIZE (CREW)	F	Complete	610.P08314	610.P08314		
	4X4	R13WH50AG/AH/AR/ AX MIDSIZE (CREW)	R	Complete	610.P08343	610.P08343		
2011-2012	4X4	R12RH50AG/AH/AM/ AR/AZ	F	Complete	610.P08314	610.P08314		



ATV/UTV CV AXLES & BOOT KITS

Polaris (continued)

Year(s)	DT	Model	Location	Type	Left Side CV	Right Side CV	Outboard CV Boot	Inboard CV Boot
500 RANGER (continued)								
	4X4	R12RH50AG/AH/AM/AR/AZ	R	Complete	610.P08343	610.P08343		
2010	4X4	R10TH50AG/AR EFI	F	Complete	610.P08311	610.P08311	600.BT2411D	600.BT2411G
	4X4	R10TH50AG/AR EFI	R	Complete	610.P08334	610.P08334	600.BT2343B	600.BT2411G
2009	4X4	R09HH50AG/AR EFI	F	Complete	610.P08311	610.P08311	600.BT2411D	600.BT2411G
	4X4	R09HH50AG/AR EFI	R	Complete	610.P08327	610.P08328	600.BT2343B	600.BT2411G
	2X4	R09RB50AF	R	Complete	610.P08327	610.P08328	600.BT2343B	600.BT2411G
2008	4X4	R08RH50AF/AR/AT	F	Complete	610.P08308	610.P08308	600.BT2343B	600.BT2411G
	4X4	R08RH50AF/AR/AT	R	Complete	610.P08347	610.P08348	600.BT2343B	600.BT2411G
	2X4	R08RB50AA	R	Complete	610.P08347	610.P08348	600.BT2343B	600.BT2411G
2007	4X4	R07RH50AA/AF/AR/AT Mfg. Before 8/28/06	F	Complete	610.P08309	610.P08309	600.BT2343A	600.BT2411G
	4X4	R07RH50AA/AF/AR/AT Mfg. Before 8/28/06	R	Complete	610.P08384	610.P08385	600.BT4087A	600.BT4087G
	4X4	R07RB50AA/RH50AA Mfg. After 8/28/06	R	Complete	610.P08347	610.P08348	600.BT2343B	600.BT2411G
	4X4	R07RH50AF/AR/AT Mfg. After 8/28/06	R	Complete	610.P08347	610.P08348	600.BT2343B	600.BT2411G
2006	4X4	R06RD50AA	F	Complete	610.P08309	610.P08309	600.BT2343A	600.BT2411G
	4X4	R06RD50AA	R	Complete	610.P08384	610.P08385	600.BT4087A	600.BT4087G
	2X4	R06RB50AA	F	Complete	610.P08309	610.P08309	600.BT2343A	600.BT2411G
	2X4	R06RB50AA	R	Complete	610.P08384	610.P08385	600.BT4087A	600.BT4087G
2005	4X4	R05RD50AA/AB/AC/AD	R	Complete	610.P08384	610.P08385	600.BT4087A	600.BT4087G
	2X4	R05RB50AA	R	Complete	610.P08384	610.P08385	600.BT4087A	600.BT4087G
500 SCRAMBLER								
2004-2009	4X4	A04 - 09 BG50AA	F	Complete	610.P08306	610.P08306	600.BT2343A	N/A
1999-2003	4X4	A99 - 03BG50AA	F	Complete	610.P08322	610.P08322	600.BT2343A	N/A
1997-1998	4X4	W97-98BC50A Stamped (BTB) on housing	F	Complete	610.P08324	610.P08324	600.BT2411A	N/A
500 SPORTSMAN								
2013-2014	4x4	Sportsman 500 1332931	F	Complete	610.P08321	610.P08321		
2013	4X4	A13MH50FF/FJ	R	Complete	610.P08329	610.P08329		
2011-2012	4X4	A12MH50FF/FX/FY	F	Complete	610.P08319	610.P08319		
	4X4	A12MH50FF/FX/FY	R	Complete	610.P08329	610.P08329		
	4X4	TRACTOR A12MN50ET/EX	F	Complete	610.P08319	610.P08319		
	4X4	TRACTOR A12MN50ET/EX	R	Complete	610.P08329	610.P08329		
2010	4X4	A10MN50ET (Tractor)	F	Complete	610.P08326	610.P08326	600.BT2069A	600.BT2069I
	4X4	A10MN50ET (Tractor)	R	Complete	610.P08354	610.P08354	600.BT3082A	600.BT3082G



ATV/UTV CV AXLES & BOOT KITS

Polaris (continued)

Year(s)	DT	Model	Location	Type	Left Side CV	Right Side CV	Outboard CV Boot	Inboard CV Boot
500 SPORTSMAN								
2009	4X4	A09MN50AN/AX	F	Complete	610.P08326	610.P08326	600.BT2069A	600.BT2069I
	4X4	A09MN50AN/AX	R	Complete	610.P08354	610.P08354	600.BT3082A	600.BT3082G
	4X4	A09MN50E (Tractor)	F	Complete	610.P08326	610.P08326	600.BT2069A	600.BT2069I
	4X4	A09MN50E (Tractor)	R	Complete	610.P08354	610.P08354	600.BT3082A	600.BT3082G
	4X4	A09DN50AB/AZ/EA (Touring)	F	Complete	610.P08326	610.P08326	600.BT2069A	600.BT2069I
	4X4	A09DN50AB/AZ/EA (Touring)	R	Complete	610.P08355	610.P08355	600.BT3082A	600.BT3082H
2008	4X4	A08DN50AF/AS/AW/AZ (Touring)	F	Complete	610.P08326	610.P08326	600.BT2069A	600.BT2069I
	4X4	A08DN50AF/AS/AW/AZ (Touring)	R	Complete	610.P08355	610.P08355	600.BT3082A	600.BT3082H
2008	4X4	A08MH50SS/AQ (Scandinavian)	F	Complete	610.P08326	610.P08326	600.BT2069A	600.BT2069I
	4X4	A08MH50SS/SQ (Scandinavian)	R	Complete	610.P08354	610.P08354	600.BT3082A	600.BT3082G
	4X4	A08DN50EA (Touring)	R	Complete	610.P08355	610.P08355	600.BT3082A	600.BT3082H
2007	4X4	A07MH50AB/AL/AQ/AX/AY/AZ Mfg. After 7/25/06	F	Complete	610.P08326	610.P08326	600.BT2069A	600.BT2069I
	4X4	A07MH50AB/AL/AQ/AX/AY/AZ	R	Complete	610.P08354	610.P08354	600.BT3082A	600.BT3082G
	4X4	A07MH50AB TO AZ Mfg. Before 7/25/06	F	Complete	610.P08317	610.P08317	600.BT2411B	600.BT190H
	4X4	A07MN50AF/AN/AT/AY Mfg. Before 7/25/06	F	Complete	610.P08317	610.P08317	600.BT2411B	600.BT190H
	4X4	A07MH50FC (INTL) Mfg. Before 7/25/06	F	Complete	610.P08317	610.P08317	600.BT2411B	600.BT190H
	4X4	A07MN50AF/AN/AT/AY Mfg. After 7/25/06	F	Complete	610.P08326	610.P08326	600.BT2069A	600.BT2069I
	4X4	A07MN50AF/AN/AT/AY	R	Complete	610.P08354	610.P08354	600.BT3082A	600.BT3082G
	4X4	A07MH50FC (International) Mfg. After 7/25/06	F	Complete	610.P08326	610.P08326	600.BT2069A	600.BT2069I
	4X4	A07MH50FC (International)	R	Complete	610.P08354	610.P08354	600.BT3082A	600.BT3082G
2006	4X4	A06MH50AQ/AX/AY/AZ/AL/AT	F	Complete	610.P08316	610.P08316		
	4X4	A06MH50AQ/AX/AY/AZ/AL/AT	R	Complete	610.P08354	610.P08354	600.BT3082A	600.BT3082G
	4X4	A06MH50FC (International)	F	Complete	610.P08316	610.P08316		



ATV/UTV CV AXLES & BOOT KITS

Polaris (continued)

Year(s)	DT	Model	Location	Type	Left Side CV	Right Side CV	Outboard CV Boot	Inboard CV Boot
500 SPORTSMAN (continued)								
	4X4	A06MH50FC (International)	R	Complete	610.P08354	610.P08354	600.BT3082A	600.BT3082G
2005	4X4	A05MH50AB/FB	F	Complete	610.P08305	610.P08305	600.BT2343A	600.BT2411G
	4X4	A05MH50AB/FB	R	Complete	610.P08301	610.P08301	600.BT4087A	600.BT4087G
2004	4X4	A04CH50A0/AX Male Inboard Splined Yoke	F	Complete	610.P08303	610.P08303	600.BT2343A	N/A
	4X4	A04CH50AA/AC/AE/AG Female Inboard Yoke	F	Complete	610.P08306	610.P08306		
	4X4	A04CH50AA/AX	R	Complete	610.P08301	610.P08301	600.BT4087A	600.BT4087G
2003	6X6	A03CL50AA	F	Complete	610.P08322	610.P08322	600.BT2343A	N/A
	4X4	A0CH50AA/AH	F	Complete	610.P08322	610.P08322		
	4X4	A0CH50AA/AH	R	Complete	610.P08301	610.P08301	600.BT4087A	600.BT4087G
2002	6X6	A02CL50AA/DA	F	Complete	610.P08322	610.P08322	600.BT4087A	600.BT4087G
	4X4	A02CH50	F	Complete	610.P08322	610.P08322	600.BT4087A	600.BT4087G
	4X4	A02CH50	R	Complete	610.P08302	610.P08302	600.BT4087A	600.BT4087G
2001	6X6	A01CH50AA	F	Complete	610.P08324	610.P08324	600.BT2411A	N/A
	4X4	A01CH50AA/AK	F	Complete	610.P08324	610.P08324	600.BT2411A	N/A
	4X4	A01CH50AA/AK	R	Complete	610.P08302	610.P08302	600.BT4087A	600.BT4087G
2000	6X6	A00CL50AA	F	Complete	610.P08324	610.P08324	600.BT2411A	N/A
	4X4	A00CH50AA-EB	F	Complete	610.P08324	610.P08324	600.BT2411A	N/A
	4X4	A00CH50AA-EB	R	Complete	610.P08302	610.P08302	600.BT4087A	600.BT4087G
1999	4X4	A99CH50AA/AB/AC/EB	F	Complete	610.P08324	610.P08324	600.BT2411A	N/A
	4X4	A99CH50AA/AB/AC/EB	R	Complete	610.P08302	610.P08302	600.BT4087A	600.BT4087G
1998	4X4	S98CH50E/50EB (Sweden)	F	Complete	610.P08324	610.P08324	600.BT2411A	N/A
	4X4	W98CH50A-AF	F	Complete	610.P08324	610.P08324	600.BT2411A	N/A
1997	4X4	S97CH50E (Sweden)	F	Complete	610.P08322	610.P08322	600.BT2343A	N/A
	4X4	W97CH50A	F	Complete	610.P08322	610.P08322	600.BT2343A	N/A
1996	4X4	S969244 (Sweden) Stamped (BTB) on housing	F	Complete	610.P08324	610.P08324	600.BT2411A	N/A
	4X4	S969244 (Sweden) Stamped (USA) on housing	F	Complete	610.P08322	610.P08322	600.BT2343A	N/A



ATV/UTV CV AXLES & BOOT KITS

Polaris (continued)

Year(s)	DT	Model	Location	Type	Left Side CV	Right Side CV	Outboard CV Boot	Inboard CV Boot
500 SPORTSMAN HO								
2012	4X4	A12MH50AD/AO/AQ/ AX/AZ	F	Complete	610.P08319	610.P08319		
	4X4	A12MH50AD/AO/AQ/ AX/AZ	R	Complete	610.P08329	610.P08329		
	4X4	TOURING A12DH50AX/ AZ	F	Complete	610.P08319	610.P08319		
2011	4X4	A11MH50AX/AZ	F	Complete	610.P08319	610.P08319		
	4X4	A11MH50AX/AZ	R	Complete	610.P08329	610.P08329		
	4X4	A11DH50AX/AZ (TOURING INTL)	F	Complete	610.P08319	610.P08319		
	4X4	A11DH50AX/AZ (TOURING INTL)	F	Complete	610.P08319	610.P08319		
2010	4X4	A10DH50AX/AZ (TOURING)	F	Complete	610.P08326	610.P08326	600.BT2069A	600.BT2069I
	4X4	A10DH50AX/AZ (TOURING)	R	Complete	610.P08355	610.P08355	600.BT3082A	600.BT3082H
	4X4	A10DH50FX (TOURING INTL)	F	Complete	610.P08326	610.P08326	600.BT2069A	600.BT2069I
	4X4	A10DH50FX (TOURING INTL)	R	Complete	610.P08355	610.P08355	600.BT3082A	600.BT3082H
	4X4	A10MH50AJ/AX/AZ	F	Complete	610.P08326	610.P08326	600.BT2069A	600.BT2069I
	4X4	A10MH50AJ/AX/AZ	R	Complete	610.P08354	610.P08354	600.BT3082A	600.BT3082G
	4X4	A10MH50FX (INTL)	F	Complete	610.P08326	610.P08326	600.BT2069A	600.BT2069I
	4X4	A10MH50FX (INTL)	R	Complete	610.P08354	610.P08354	600.BT3082A	600.BT3082G
2009	4X4	A09MH50AS/AX/AZ	F	Complete	610.P08326	610.P08326	600.BT2069A	600.BT2069I
	4X4	A09MH50AS/AX/AZ	R	Complete	610.P08354	610.P08354	600.BT3082A	600.BT3082G
2008	4X4	A08MH50AX/AZ	F	Complete	610.P08326	610.P08326	600.BT2069A	600.BT2069I
	4X4	A08MH50AX/AZ	R	Complete	610.P08354	610.P08354	600.BT3082A	600.BT3082G
	4X4	A08MN50AF/AN/AQ/ AR/AS/AT/AW/AX	F	Complete	610.P08326	610.P08326	600.BT2069A	600.BT2069I
	4X4	A08MN50AF/AN/AQ/ AR/AS/AT/AW/AX	R	Complete	610.P08354	610.P08354	600.BT3082A	600.BT3082G
2006	4X4	A06MH50AA/AB/ AD/AF Mfg. Before 10/03/06	F	Complete	610.P08316	610.P08316		
	4X4	A06MH50AA/AB/AD/ AF Mfg. After 10/03/06	F	Complete	610.P08305	610.P08305	600.BT2343A	600.BT2411G
	4X4	A06MH50AA/AB/ AD/AF	R	Complete	610.P08354	610.P08354	600.BT3082A	600.BT3082G
	4X4	A06MH50FB/FC (INTL)	F	Complete	610.P08316	610.P08316		
	4X4	A06MH50FB/FC (INTL)	R	Complete	610.P08354	610.P08354	600.BT3082A	600.BT3082G



ATV/UTV CV AXLES & BOOT KITS

Polaris (continued)

Year(s)	DT	Model	Location	Type	Left Side CV	Right Side CV	Outboard CV Boot	Inboard CV Boot
500 SPORTSMAN HO (continued)								
2005	4X4	A05MH50AB (INTL)	F	Complete	610.P08305	610.P08305	600.BT2343A	600.BT2411G
	4X4	A05MH50AB (INTL)	R	Complete	610.P08301	610.P08301		
2004	4X4	A04CG50A0/AX (Male Inboard yoke)	F	Complete	610.P08303	610.P08303		
	4X4	A04CH50AA/AC/AE/AG (Female inboard yoke)	F	Complete	610.P08306	610.P08306		
	4X4	A04CH50AA/AX	R	Complete	610.P08301	610.P08301		
2003	4X4	A03CH50AA/AB/AC/AD/AE/AH/AJ	F	Complete	610.P08322	610.P08322		
	4X4	A03CH50AA/AB/AC/AD/AE/AH/AJ	R	Complete	610.P08301	610.P08301		
500 SPORTSMAN X2								
2008-2009	4X4	A09 / 08TN50EA	F	Complete	610.P08326	610.P08326	600.BT2069A	600.BT2069I
	4X4	A09 / 08TN50EA	R	Complete	610.P08355	610.P08355	600.BT3082A	600.BT3082H
	4X4	A09TN50AX/AY	F	Complete	610.P08326	610.P08326	600.BT2069A	600.BT2069I
	4X4	A09TN50AX/AZ	R	Complete	610.P08355	610.P08355	600.BT3082A	600.BT3082H
2007	4X4	A07TH50AL/AU/AZ Mfg. After 7/25/06	F	Complete	610.P08326	610.P08326	600.BT2069A	600.BT2069I
	4X4	A07TN50AF/AS/AU Mfg. After 7/25/06	F	Complete	610.P08326	610.P08326	600.BT2069A	600.BT2069I
	4X4	A07TH50EA Mfg. After 7/25/06	F	Complete	610.P08326	610.P08326	600.BT2069A	600.BT2069I
	4X4	A07TH50AL/AQ/AU/AZ Mfg. Before 7/25/06	F	Complete	610.P08317	610.P08317	600.BT2411B	600.BT190H
	4X4	A07TH50AL/AQ/AU/AZ	R	Complete	610.P08346	610.P08346	600.BT3082A	600.BT3082H
	4X4	A07TH50AF/AS/AU Mfg. Before 7/25/06	F	Complete	610.P08317	610.P08317	600.BT2411B	600.BT190H
	4X4	A07TN50AF/AS/AU	R	Complete	610.P08346	610.P08346	600.BT3082A	600.BT3082H
	4X4	A07TH50EA Mfg. Before 7/25/06	F	Complete	610.P08317	610.P08317	600.BT2411B	600.BT190H
	4X4	A07TH50EA	R	Complete	610.P08346	610.P08346	600.BT3082A	600.BT3082H
500 WORKER								
1999	4X4	A99CH50EA/EB	F	Complete	610.P08324	610.P08324	600.BT2411A	N/A
	4X4	A99CH50EA/EB	R	Complete	610.P08302	610.P08302	600.BT4087A	600.BT4087G
500 XPLORER								
1997	4X4	W97CD50A	F	Complete	610.P08322	610.P08322	600.BT2343A	N/A



ATV/UTV CV AXLES & BOOT KITS

Polaris (continued)

Year(s)	DT	Model	Location	Type	Left Side CV	Right Side CV	Outboard CV Boot	Inboard CV Boot	
550 SPORTSMAN									
2010-2013	4X4	A10-13ZN55AA / AQ / AZ	F	Complete	610.P08312	610.P08312			
	4X4	A10-13ZN55AA / AQ / AZ	R	Complete	610.P08342	610.P08342			
	4X4	A10-13ZN5EAD / K / L / T	F	Complete	610.P08312	610.P08312			
	4X4	A10-13ZN5EAD / K / L / T	R	Complete	610.P08342	610.P08342			
	4X4	A10-13DN5EAF EAR (TOURING EPS)	F	Complete	610.P08312	610.P08312			
	4X4	A10-13DN5EAF EAR (TOURING EPS)	R	Complete	610.P08342	610.P08342			
	4X4	A10-13ZN5EFF	F	Complete	610.P08312	610.P08312			
	4X4	A10-13ZN5EFF	R	Complete	610.P08342	610.P08342			
	4X4	A10-13DN5EFL (TOURING EPS INTL)	F	Complete	610.P08312	610.P08312			
	4X4	A10-13DN5EFL (TOURING EPS INTL)	R	Complete	610.P08342	610.P08342			
	4X4	A10-13TN55AA / AZ (X2)	F	Complete	610.P08312	610.P08312			
	4X4	A10-13TN55AA / AZ (X2)	R	Complete	610.P08342	610.P08342			
	4X4	A10-13TN55FA (X2 INTL)	F	Complete	610.P08312	610.P08312			
	4X4	A10-13TN55FA (X2 INTL)	R	Complete	610.P08342	610.P08342			
	2009	4X4	A09ZN55AL/AQ/AS/AT/AX (XP)	F	Complete	610.P08312	610.P08312		
		4X4	A09ZN55AL/AQ/AS/AT/AX (XP)	R	Complete	610.P08344	610.P08344	600.BT3082A	600.BT3082G
4X4		A09ZN55FX (XP INTL)	F	Complete	610.P08312	610.P08312			
4X4		A09ZN55FX (XP INTL)	R	Complete	610.P08344	610.P08344	600.BT3082A	600.BT3082G	
4X4		A09ZX55AC/AL/AQ/AS/AX (XP EPS)	F	Complete	610.P08312	610.P08312			
4X4	A09ZX55AC/AL/AQ/AS/AX (XP EPS)	R	Complete	610.P08344	610.P08344	600.BT3082A	600.BT3082G		
570 SPORTSMAN									
2013-2014	4x4	Sportsman 570 1332931	F	Complete	610.P08321	610.P08321			
570 RANGER RZR									
2012-2013	4X4	R13VH57AD/6EAK EFI	F	Complete	610.P08304	610.P08304			
2013-2014	4x4	RZR 570 Ranger 1332954	R	Complete	610.P08357	610.P08357			
600 SPORTSMAN									
2005	4X4	A05MH59AK/AN	F	Complete	610.P08305	610.P08305	600.BT2343A	600.BT2411G	
	4X4	A05MH59AK/AN	R	Complete	610.P08301	610.P08301	600.BT4087A	600.BT4087G	
2004	4X4	A04CH59AF/AH/AJ/AT/AV	F	Complete	610.P08310	610.P08310	600.BT2343A	N/A	
	4X4	A04CH59AF/AH/AJ/AT/AV	R	Complete	610.P08301	610.P08301	600.BT4087A	600.BT4087G	
2003	4X4	A03CH59AA/AF/AG Mfg. Before 10/03/02	F	Complete	610.P08303	610.P08303	600.BT2343A	N/A	
	4X4	A03CH59AA/AF/AG Mfg. After 10/03/02	F	Complete	610.P08310	610.P08310	600.BT2343A	N/A	
	4X4	A03CH59AA/AF/AG	R	Complete	610.P08301	610.P08301	600.BT2343A	N/A	



ATV/UTV CV AXLES & BOOT KITS

Polaris (continued)

Year(s)	DT	Model	Location	Type	Left Side CV	Right Side CV	Outboard CV Boot	Inboard CV Boot
700 RANGER								
2009	6X6	R09RF68AF/AR/AZ	F	Complete	610.P08308	610.P08308	600.BT2343B	600.BT2411G
	4X4	R09WH68AC/AG/AH/AL/AR/AZ CREW	F	Complete	610.P08308	610.P08308	600.BT2343B	600.BT2411G
	4X4	R09WH68AC/AG/AH/AL/AR/AZ CREW	R	Complete	610.P08327	610.P08328	600.BT2343B	600.BT2411G
	4X4	R09HH68/HY68 ALL OPTIONS	F	Complete	610.P08311	610.P08311	600.BT2411D	600.BT2411G
	4X4	R09HH68/HY68 ALL OPTIONS	R	Complete	610.P08327	610.P08328	600.BT2343B	600.BT2411G
2008	6X6	R08RF68AD/AF/AZ	F	Complete	610.P08308	610.P08308	600.BT2343B	600.BT2411G
	4X4	R08WH68AG/AH/AK/AR CREW	F	Complete	610.P08308	610.P08308	600.BT2343B	600.BT2411G
	4X4	R08WH68AG/AH/AK/AR CREW	R	Complete	610.P08347	610.P08348	600.BT2343B	600.BT2411G
	4X4	R08RH68 EFI/XP ALL OPTIONS	F	Complete	610.P08308	610.P08308	600.BT2343B	600.BT2411G
	4X4	R08RH68 EFI/XP ALL OPTIONS	R	Complete	610.P08347	610.P08348	600.BT2343B	600.BT2411G
700 RANGER								
2007	4X4	R07RH68AD/AG/AH/AK/AL/AO/AP/AW	F	Complete	610.P08309	610.P08309	600.BT2343A	600.BT2411G
	4X4	R07RH68AD/G/H/K/L/O/P/W Mfg. Before 8/28/06	R	Complete	610.P08384	610.P08385	600.BT4087A	600.BT4087G
	4X4	R07RH68AD/G/H/K/L/O/P/W Mfg. After 8/28/06	R	Comple	610.P08347	610.P08348	600.BT2343B	600.BT2411G
700 RANGER XP								
2006	4X4	R06RD68AA/AB/AC/AD/AE/AF	F	Complete	610.P08309	610.P08309	600.BT2343A	600.BT2411G
	4X4	R06RD68AA/AB/AC/AD/AE/AF	R	Complete	610.P08384	610.P08385	600.BT4087A	600.BT4087G
2005	4X4	R05RD68AA/AB	R	Complete	610.P08384	610.P08385	600.BT4087A	600.BT4087G
700 SPORTSMAN								
2007	4X4	A07MH68AX/AY/AZ Mfg. Before 7/25/06	F	Complete	610.P08317	610.P08317	600.BT2411B	600.BT190H
	4X4	A07MH68AX/AY/AZ Mfg. After 7/25/06	F	Complete	610.P08326	610.P08326	600.BT2069A	600.BT2069I
	4X4	A07MH68AX/AY/AZ	R	Complete	610.P08354	610.P08354	600.BT3082A	600.BT3082G
2006	4X4	A06MH68AA/AD/AF/AQ/AT/AX/AY/AT/AZ	F	Complete	610.P08316	610.P08316	600.BT3082A	600.BT3082G
	4X4	A06MH68AA/AD/AF	R	Complete	610.P08354	610.P08354	600.BT3082A	600.BT3082G



ATV/UTV CV AXLES & BOOT KITS

Polaris (continued)

Year(s)	DT	Model	Location	Type	Left Side CV	Right Side CV	Outboard CV Boot	Inboard CV Boot
700 SPORTSMAN (continued)								
2005	4X4	A05MH68AK/AN/AD	F	Complete	610.P08305	610.P08305	600.BT2343A	600.BT2411G
	4X4	A05MH68AK/AN/AD	R	Complete	610.P08301	610.P08301	600.BT4087A	600.BT4087G
	4X4	A05MH68AC/AS/AT/AU/AW	F	Complete	610.P08305	610.P08305	600.BT2343A	600.BT2411G
	4X4	A05MH68AC/AS/AT/AU/AW	R	Complete	610.P08301	610.P08301	600.BT4087A	600.BT4087G
2004	4X4	A04CH68AC/AF/AH/AJ/AT/AV	F	Complete	610.P08310	610.P08310	600.BT2343A	N/A
	4X4	A04CH68AC/AF/AH/AJ/AT/AV	R	Complete	610.P08301	610.P08301	600.BT4087A	600.BT4087G
2003	4X4	A03CH68AA/AC/AF/AH/AL Mfg. Before 10/03/02	F	Complete	610.P08303	610.P08303	600.BT2343A	N/A
	4X4	A03CH68AA/AC/AF/AH/AL Mfg. After 10/03/02	F	Complete	610.P08310	610.P08310	600.BT2343A	N/A
	4X4	A03CH68AA/AC/AF/AH/AL	R	Complete	610.P08301	610.P08301	600.BT4087A	600.BT4087G
2002	4X4	A02CH68AA/AB/AC/CA/CB Mfg. After 5/01/02	F	Complete	610.P08303	610.P08303	600.BT2343A	N/A
700 SPORTSMAN X2								
2008	4X4	A08TN68AX/AZ	F	Complete	610.P08326	610.P08326	600.BT2069A	600.BT2069I
	4X4	A08TN68AX/AZ	R	Complete	610.P08355	610.P08355	600.BT3082A	600.BT3082H
800 RANGER								
2012-2013	6X6	R12-13HR76AG/AR	F	Complete	610.P08311	610.P08311	600.BT2411D	600.BT2411G
	6X6	R12-13HR76AG/AR	R	Complete	610.P08327	610.P08328	600.BT2343B	600.BT2411G
	4X4	R12TH76 TH7E/TX7E XP	F	Complete	610.P08311	610.P08311	600.BT2411D	600.BT2411G
	4X4	R12TH76 TH7E/TX7E XP	R	Complete	610.P08334	610.P08334	600.BT2343B	600.BT2411G
	4X4	R12-13WH76AG/AR/EAH/EAV CREW	F	Complete	610.P08311	610.P08311	600.BT2411D	600.BT2411G
	4X4	R12-13WH76AG/AR/EAH/EAV CREW	R	Complete	610.P08334	610.P08334	600.BT2343B	600.BT2411G
2011	6X6	R11HR76AG/AR	F	Complete	610.P08311	610.P08311	600.BT2411D	600.BT2411G
	6X6	R11HR76AG/AR	R	Complete	610.P08327	610.P08328	600.BT2343B	600.BT2411G
800 RANGER								
2011	4X4	R11TH76/TY76 EFI ALL OPTIONS	F	Complete	610.P08311	610.P08311	600.BT2411D	600.BT2411G
	4X4	R11TH76/TY76 EFI ALL OPTIONS	R	Complete	610.P08334	610.P08334	600.BT2343B	600.BT2411G
	4X4	R11WH76AG/AR/WY76AE/AH/AJ EFI CREW	F	Complete	610.P08311	610.P08311	600.BT2411D	600.BT2411G
	4X4	R11WH76AG/AR/WY76AE/AH/AJ EFI CREW	R	Complete	610.P08334	610.P08334	600.BT2343B	600.BT2411G



ATV/UTV CV AXLES & BOOT KITS

Polaris (continued)

Year(s)	DT	Model	Location	Type	Left Side CV	Right Side CV	Outboard CV Boot	Inboard CV Boot
800 RANGER (continued)								
2010	6X6	R10HR76AG/AR EFI	F	Complete	610.P08311	610.P08311	600.BT2411D	600.BT2411G
	6X6	R10HR76AG/AR EFI	R	Complete	610.P08327	610.P08328	600.BT2343B	600.BT2411G
	4X4	R10TH76TY EFI ALL OPTIONS	F	Complete	610.P08311	610.P08311	600.BT2411D	600.BT2411G
	4X4	R10TH76TY EFI ALL OPTIONS	R	Complete	610.P08334	610.P08334	600.BT2343B	600.BT2411G
	4X4	R10WH76AG/AH/AR/AV/WY76AW/AZ EFI CREW	F	Complete	610.P08311	610.P08311	600.BT2411D	600.BT2411G
	4X4	R10WH76AG/AH/AR/AV/WY76AW/AZ EFI CREW	R	Complete	610.P08334	610.P08334	600.BT2343B	600.BT2411G
800 RANGER RZR								
2008-2012	4X4	R08-12VH76AB/AD/AF/AH/AI/AJ/EAB/EAS RZR EPS	F	Complete	610.P08304	610.P08304	600.BT2411D	600.BT2411G
	4X4	R0812VH76AB/AD/AF/AH/AI/AJ/EAB/EAS RZR EPS	R	Complete	610.P08372	610.P08372	600.BT2343B	600.BT2411G
800 RANGER RZR "S" & RZR "4"								
2012	4X4	R12XE76AD/7EAB/EO RANGER RZR "4" 800	F	Complete	610.P08307	610.P08307	600.BT2411D	600.BT2411G
	4X4	R12XE76AD/7EAB/EO RANGER RZR "4" 800	R	Complete	610.P08338	610.P08338	600.BT2343B	600.BT2411G
	4X4	R12XE76FX RANGER RZR "4" 800 EFI (Intl)	F	Complete	610.P08307	610.P08307	600.BT2411D	600.BT2411G
	4X4	R12VE76AB/AD/AE/AJ/AO RANGER RZR "S" 800	F	Complete	610.P08307	610.P08307	600.BT2411D	600.BT2411G
	4X4	R12VE76AB/AD/AE/AJ/AO RANGER RZR "S" 800	R	Complete	610.P08338	610.P08338	600.BT2343B	600.BT2411G
	4X4	R12VE76FX/FI RANGER RZR "S"(INTL/ISRAEL)	F	Complete	610.P08307	610.P08307	600.BT2411D	600.BT2411G
2011	4X4	RV11VE76AC/AD/AW RANGER RZR "S" 800	F	Complete	610.P08307	610.P08307	600.BT2411D	600.BT2411G
	4X4	RV11VE76AC/AD/AW RANGER RZR "S" 800	R	Complete	610.P08338	610.P08338	600.BT2343B	600.BT2411G
	4X4	R11XH76AW/AZ/XY76AA RZR "4" / EPS/RGE	F	Complete	610.P08307	610.P08307	600.BT2411D	600.BT2411G
	4X4	R11XH76AW/AZ/XY76AA RZR "4" / EPS/RGE	R	Complete	610.P08338	610.P08338	600.BT2343B	600.BT2411G
	4X4	R11XH76AW/XY76AA RANGER "4" / EPS	F	Complete	610.P08307	610.P08307	600.BT2411D	600.BT2411G

ATV/UTV CV AXLES & BOOT KITS



Polaris (continued)

Year(s)	DT	Model	Location	Type	Left Side CV	Right Side CV	Outboard CV Boot	Inboard CV Boot
800 RANGER RZR "S" & RZR "4" (continued)								
	4X4	R11XH76AW/XY76AA RANGER "4" / EPS	R	Complete	610.P08338	610.P08338	600.BT2343B	600.BT2411G
	4X4	R11VM76FX RANGER RZR / EPS INTL	F	Complete	610.P08307	610.P08307	600.BT2411D	600.BT2411G
	4X4	R11VM76FX RANGER RZR / EPS INTL	R	Complete	610.P08338	N/A	600.BT2343B	600.BT2411G
2009-2010	4X4	R09-10VH76AB/AO/AQ/AW RANGER RZR "S" 800	F	Complete	610.P08307	610.P08307	600.BT2411D	600.BT2411G
	4X4	R09-10VH76AB-AW RANGER RZR "S" 800 EFI	R	Complete	610.P08338	610.P08338	600.BT2343B	600.BT2411G
	4X4	R09-10XH76AA RANGER 4 800 EFI	F	Complete	610.P08307	610.P08307	600.BT2411D	600.BT2411G
	4X4	R09-10XH76AA RANGER 4 800 EFI	R	Complete	610.P08338	610.P08338	600.BT2343B	600.BT2411G
	4X4	R09-10VH76FX RANGER RZR 800 "S" 800 INTL	F	Complete	610.P08307	610.P08307	600.BT2411D	600.BT2411G
	4X4	R09-10VH76FX RANGER RZR 800 "S" 800 INTL	R	Complete	610.P08338	610.P08338	600.BT2343B	600.BT2411G
800 SPORTSMAN								
2013-2014	4x4	Sportsman 800 1332931	F	Complete	610.P08321	610.P08321		
2013	4X4	A13MH76AD/AX/AZ	R	Complete	610.P08329	610.P08329		
	4X4	A13MH76FF	R	Complete	610.P08329	610.P08329		
2012	4X4	A12MH76AD/AX/AZ	F	Complete	610.P08319	610.P08319		
	4X4	A12MH76AD/AX/AZ	R	Complete	610.P08329	610.P08329		
	4X4	A12MH76FF	F	Complete	610.P08319	610.P08319		
	4X4	A12MH76FF	R	Complete	610.P08329	610.P08329		
2011	4X4	A11MH76AX/AZ	F	Complete	610.P08319	610.P08319		
	4X4	A11MH76AX/AZ	R	Complete	610.P08329	610.P08329		
	6X6	A11CF76AA	F	Complete	610.P08319	610.P08319		
2010	6X6	A10CL76AA	F	Complete	610.P08326	610.P08326	600.BT2069A	600.BT2069I
	6X6	A10CL76AA	R	Complete	610.P08354	610.P08354	600.BT3082A	600.BT3082G
	4X4	A10MN76AX/AZ	F	Complete	610.P08326	610.P08326	600.BT2069A	600.BT2069I
	4X4	A10MN76AX/AZ	R	Complete	610.P08354	610.P08354	600.BT3082A	600.BT3082G
2009	6X6	A09CL76AA	F	Complete	610.P08326	610.P08326	600.BT2069A	600.BT2069I
	6X6	A09CL76AA	R	Complete	610.P08354	610.P08354	600.BT3082A	600.BT3082G
	4X4	A09MN76AX/AZ	F	Complete	610.P08326	610.P08326	600.BT2069A	600.BT2069I
	4X4	A09MN76AX/AZ	R	Complete	610.P08354	610.P08354	600.BT3082A	600.BT3082G
	4X4	A09DN76AB/AL/AY	F	Complete	610.P08326	610.P08326	600.BT2069A	600.BT2069I
	4X4	A09DN76AB/AL/AY	R	Complete	610.P08355	610.P08355	600.BT3082A	600.BT3082H
	4X4	A09DN76FC (International)	F	Complete	610.P08326	610.P08326	600.BT2069A	600.BT2069I



ATV/UTV CV AXLES & BOOT KITS

Polaris (continued)

Year(s)	DT	Model	Location	Type	Left Side CV	Right Side CV	Outboard CV Boot	Inboard CV Boot
800 SPORTSMAN (continued)								
	4X4	A09DN76FC (International)	R	Complete	610.P08355	610.P08355	600.BT3082A	600.BT3082H
2008	4X4	A08DN76AF/AG/AH/AL/ AJ/AS (Touring)	F	Complete	610.P08326	610.P08326	600.BT2069A	600.BT2069I
	4X4	A08DN76AF/AG/AH/AL/ AJ/AS (Touring)	R	Complete	610.P08355	610.P08355	600.BT3082A	600.BT3082H
	4X4	A08DN76FC (International)	F	Complete	610.P08326	610.P08326	600.BT2069A	600.BT2069I
	4X4	A08DN76FC (International)	R	Complete	610.P08355	610.P08355	600.BT3082A	600.BT3082H
	4X4	A08MH76SF/SS (Scandinavian)	F	Complete	610.P08326	610.P08326	600.BT2069A	600.BT2069I
	4X4	A08MH76SF/SS (Scandinavian)	R	Complete	610.P08354	610.P08354	600.BT3082A	600.BT3082G
2007	4X4	A07MN76AF/AT/AY Mfg. Before 7/25/06	F	Complete	610.P08317	610.P08317	600.BT2411B	600.BT190H
	4X4	A07MH76AL/AQ/AX/AY/ AZ Before 7/25/06	F	Complete	610.P08317	610.P08317	600.BT2411B	600.BT190H
	4X4	A07MH76AF (International) Before 7/25/06	F	Complete	610.P08317	610.P08317	600.BT2411B	600.BT190H
	4X4	A07MN76AF/AT/AY Mfg. After 7/25/06	F	Complete	610.P08326	610.P08326	600.BT2069A	600.BT2069I
	4X4	A07MN76AF/AT/AY	R	Complete	610.P08354	610.P08354	600.BT3082A	600.BT3082G
	4X4	A07MH76AL/AQ/AX/AY/ AZ Mfg. After 7/25/06	F	Complete	610.P08326	610.P08326	600.BT2069A	600.BT2069I
	4X4	A07MH76AL/AQ/AX/ AY/AZ	R	Complete	610.P08354	610.P08354	600.BT3082A	600.BT3082G
	4X4	A07MH76FA (International) Mfg. After 7/25/06	F	Complete	610.P08326	610.P08326	600.BT2069A	600.BT2069I
	4X4	A07MH76FA (International)	R	Complete	610.P08354	610.P08354	600.BT3082A	600.BT3082G
2006	4X4	A06MH76AL-AZ Mfg. Before 9/5/05	F	Complete	610.P08316	610.P08316		
	4X4	A06MH76AL-AZ Mfg. Between 9/5/05 & 11/11/05	F	Complete	610.P08305	610.P08305	600.BT2343A	600.BT2411G
	4X4	A06MH76AL-AZ Mfg. After 11/11/05	F	Complete	610.P08316	610.P08316		
	4X4	A06MH76AL/AQ/AT/AX/ AY/AZ	R	Complete	610.P08354	610.P08354	600.BT3082A	600.BT3082G
2005	4X4	A05MH76AC/AT/AU/AW	F	Complete	610.P08305	610.P08305	600.BT2343A	600.BT2411G
	4X4	A05MH76AC/AT/AU/AW	R	Complete	610.P08301	610.P08301	600.BT4087A	600.BT4087G



ATV/UTV CV AXLES & BOOT KITS

Polaris (continued)

Year(s)	DT	Model	Location	Type	Left Side CV	Right Side CV	Outboard CV Boot	Inboard CV Boot
800 SPORTSMAN HO								
2009	4X4	A09MN76AX/AZ	F	Complete	610.P08319	610.P08319		
	4X4	A09MN76AX/AZ	R	Complete	610.P08354	610.P08354	600.BT3082A	600.BT3082G
2008	4X4	A08MN76AF/AL/AQ/AR/AS/AT/AX	F	Complete	610.P08326	610.P08326	600.BT2069A	600.BT2069I
	4X4	A08MN76AF/AL/AQ/AR/AS/AT/AX	R	Complete	610.P08354	610.P08354	600.BT3082A	600.BT3082G
800 SPORTSMAN X2								
2008-2009	4X4	A08-09TN76AL/AX/AZ	F	Complete	610.P08326	610.P08326	600.BT2069A	600.BT2069I
	4X4	A08-09TN76AL/AX/AZ	R	Complete	610.P08355	610.P08355	600.BT3082A	600.BT3082H
2007	4X4	A07TH76AU Mfg. Before 7/25/06	F	Complete	610.P08317	610.P08317	600.BT2411B	600.BT190H
	4X4	A07TH76AU Mfg. After 7/25/06	F	Complete	610.P08326	610.P08326	600.BT2069A	600.BT2069I
	4X4	A07TH76AU Mfg. Before 7/25/07	R	Complete	610.P08346	610.P08346	600.BT3082A	600.BT3082H
	4X4	A07TN76AF/AL/AU Mfg. Before 7/25/06	F	Complete	610.P08317	610.P08317	600.BT2411B	600.BT190H
	4X4	A07TN76AF/AL/AU Mfg. After 7/25/06	F	Complete	610.P08326	610.P08326	600.BT2069A	600.BT2069I
	4X4	A07TN76AF/AL/AU Mfg. Before 7/25/07	R	Complete	610.P08346	610.P08346	600.BT3082A	600.BT3082H
850 SPORTSMAN								
2010-2013	4X4	A10-13DN8EFW (EPS INTL)	F	Complete	610.P08312	610.P08312		
	4X4	A10-13DN8EFW (EPS INTL)	R	Complete	610.P08342	610.P08342		
	4X4	A10-13DNEAF / EAL / EAR (HO TOURING EPS)	F	Complete	610.P08312	610.P08312		
	4X4	A10-13DNEAF / EAL / EAR (HO TOURING EPS)	R	Complete	610.P08342	610.P08342		
	4X4	A10-13ZN85AA / AQ / AZ (XP)	F	Complete	610.P08312	610.P08312		
	4X4	A10-13ZN85AA / AQ / AZ (XP)	R	Complete	610.P08342	610.P08342		
	4X4	A10-13ZN8EAD / K / L / T (HO EPS)	F	Complete	610.P08312	610.P08312		
	4X4	A-1013ZN8EAD / K / L / T (HO EPS)	R	Complete	610.P08342	610.P08342		
2009	4X4	A09ZN85/8X (XP)	F	Complete	610.P08312	610.P08312		
	4X4	A09ZN85/8X (XP)	R	Complete	610.P08344	610.P08344	600.BT3082A	600.BT3082G
	4X4	A09ZN85FL/8CFL(XP INTL)	F	Complete	610.P08312	610.P08312		
	4X4	A09ZN85FL/8CFL(XP INTL)	R	Complete	610.P08344	610.P08344	600.BT3082A	600.BT3082G
	4X4	A09ZX85/8X (XP EPS)	F	Complete	610.P08312	610.P08312		
	4X4	A09ZX85/8X (XP EPS)	R	Complete	610.P08344	610.P08344	600.BT3082A	600.BT3082G



ATV/UTV CV AXLES & BOOT KITS

Polaris (continued)

Year(s)	DT	Model	Location	Type	Left Side CV	Right Side CV	Outboard CV Boot	Inboard CV Boot
850 SPORTSMAN HO								
2013	4X4	A13DN8EAF/EAL/EAR (EPS TOURING)	F	Complete	610.P08312	610.P08312	600.BT2343B	600.BT2411G
	4X4	A13DN8EAF/EAL/EAR (EPS TOURING)	R	Complete	610.P08342	610.P08342		
	4X4	A13DN8EFW (EPS TOURING INTL)	F	Complete	610.P08312	610.P08312		
	4X4	A13DN8EFW (EPS TOURING INTL)	R	Complete	610.P08342	610.P08342		
900 RANGER								
2013	4X4	R13UH88/UH9EXP (ALL OPTIONS)	F	Complete	610.P08307	610.P08307		
	4X4	R13TH90DG DIESEL	F	Complete	610.P08318	610.P08318		
	4X4	R13TH90DG DIESEL	R	Complete	610.P08394	610.P08395		
	4X4	R13WH90DG DIESEL(CREW)	F	Complete	610.P08318	610.P08318		
	4X4	R13WH90DG DIESEL(CREW)	R	Complete	610.P08394	610.P08395		
2012	4X4	R12TH90DG DIESEL	F	Complete	610.P08318	610.P08318		
	4X4	R12TH90DG DIESEL	R	Complete	610.P08394	610.P08395		
	4X4	R12WH90DG DIESEL(CREW)	F	Complete	610.P08318	610.P08318		
	4X4	R12WH90DG DIESEL(CREW)	R	Complete	610.P08394	610.P08395		
2011	4X4	R11TH90DG DIESEL	F	Complete	610.P08318	610.P08318		
	4X4	R11TH90DG DIESEL	R	Complete	610.P08394	610.P08395		
900 RANGER RZR XP								
2014	4X4	Z14JT87AD/9EAO RZR	F	Complete	610.P08313	610.P08313		
	4X4	Z14JT87AD/9EAO RZR	R	Complete	610.P08340	610.P08340		
	4X4	Z14JT9EFX RZR INTL	F	Complete	610.P08313	610.P08313		
	4X4	Z14JT9EFX RZR INTL	R	Complete	610.P08340	610.P08340		
	4X4	Z14XT9EAO RZR 4	F	Complete	610.P08313	610.P08313		
	4X4	Z14XT9EAO RZR 4	R	Complete	610.P08340	610.P08340		
2011-2013	4X4	R11-13JT87AD/AL/EAL RZR XP EFI	F	Complete	610.P08313	610.P08313		
	4X4	R11-13JT87AD/AL/EAL RZR XP EFI	R	Complete	610.P08340	610.P08340		
	4X4	R11-13XT9EFX RZR XP PS INTL	F	Complete	610.P08313	610.P08313		
	4X4	R11-13XT9EFX RZR XP PS INTL	R	Complete	610.P08340	610.P08340		
	4X4	R11-13XT87AA/9EAK RZR 4 XP EFI	F	Complete	610.P08313	610.P08313		
	4X4	R11-13XT87AA/9EAK RZR 4 XP EFI	R	Complete	610.P08340	610.P08340		
1000 Ranger RZR XP								
2013-2014	4x4	Ranger RZR1000 XP 1333123	F	Complete	610.P08323	610.P08323		
	4X4	Ranger RZR1000 XP 1333124	R	Complete	610.P08374	610.P08374		

ATV/UTV CV AXLES & BOOT KITS



Suzuki

Year(s)	DT	Model	Location	Type	Left Side CV	Right Side CV	Outboard CV Boot	Inboard CV Boot
400 KING QUAD								
2008-2012	4X4	LT-A400F	F	Complete	610.SK8301	610.SK8302		
	4X4	LT-A400F	F	Complete	610.SK8301	610.SK8302		
	4X4	LT-F400F	F	Complete	610.SK8301	610.SK8302		
	4X4	LT-F400F	F	Complete	610.SK8301	610.SK8302		
450 KING QUAD								
2007-2009	4X4	LT-A450X/LT-A450XZ	F	Complete	610.SK8300	610.SK8300	600.BT2075A	600.BT2069L
	4X4	LT-A450X/LT-A450XZ	R	Complete	610.SK8320	610.SK8320	600.BT2075D	600.BT2069M
500 KING QUAD								
2011-2013	4X4	LT-A500 XP/XPZ	F	Complete	610.SK8303	610.SK8303		
	4X4	LT-A500 XP/XPZ	R	Complete	610.SK8343	610.SK8343		
	4X4	LT-A500 X/XZ	F	Complete	610.SK8304	610.SK8304		
	4X4	LT-A500 X/XZ	R	Complete	610.SK8344	610.SK8344		
500 VINSON								
2004-2007	4X4	LT-A500F	F	Complete	610.SK8102	610.SK8202	600.BT702A	600.BT701H
700 KING QUAD								
2006-2007	4X4	LT-A700X	F	Complete	610.SK8300	610.SK8300	600.BT2075A	600.BT2069L
	4X4	LT-A700X	R	Complete	610.SK8320	610.SK8320	600.BT2075D	600.BT2069M
750 KING QUAD								
2008-2009	4X4	LT-A750X/LT-A750XZ	F	Complete	610.SK8300	610.SK8300	600.BT2075A	600.BT2069L
	4X4	LT-A750X/LT-A750XZ	R	Complete	610.SK8320	610.SK8320	600.BT2075D	600.BT2069M
2011-2013	4X4	LT-A750 XP/XPZ	F	Complete	610.SK8303	610.SK8303		
	4X4	LT-A750 XP/XPZ	R	Complete	610.SK8343	610.SK8343		
	4X4	LT-A750 X/XZ	F	Complete	610.SK8304	610.SK8304		
	4X4	LT-A750 X/XZ	R	Complete	610.SK8344	610.SK8344		

Yamaha

Year(s)	DT	Model	Location	Type	Left Side CV	Right Side CV	Outboard CV Boot	Inboard CV Boot
250 TIMBERWOLF								
1994-2000	4X4	YFB250FWF	F	HalfShaft	610.YA7303	610.YA7303	600.BT702A	600.BT701G
350 BIG BEAR								
1999	4X4	YFM350FWBL/FHLC	F	Complete	610.YA8307	610.YA8307	600.BT702A	600.BT702J
1998	4X4	YFM350FWBK/BKC	F	Complete	610.YA8307	610.YA8307	600.BT702A	600.BT702J
1997	4X4	YFM350FWSJ Inboard Housing Stamped 68AC	F	HalfShaft	610.YA7303	610.YA7303	600.BT702A	600.BT701G
	4X4	YFM350FWSJ Inboard Housing Stamped 68LAC	F	Complete	610.YA8307	610.YA8307	600.BT702A	600.BT702J
1989-1996	4X4	YFM350FW	F	HalfShaft	610.YA7303	610.YA7303	600.BT702A	600.BT701G



ATV/UTV CV AXLES & BOOT KITS

Yamaha (continued)

Year(s)	DT	Model	Location	Type	Left Side CV	Right Side CV	Outboard CV Boot	Inboard CV Boot
350 BRUIN								
2004-2006	4X4	YFM350FA	F	Complete	610.YA8311	610.YA8311		
350 GRIZZLY								
2007-2011	4X4	(IRS) YFM35FG	F	Complete	610.YA8126	610.YA8226	600.BT702A	600.BT3068G
	4x4	YFM35FG	F	Complete	610.YA8311	610.YA8311		
	4X4	(IRS) YFM35FG	R	Complete	610.YA8333	610.YA8333	600.BT702A	600.BT3068G
350 WOLVERINE								
2001-2005	4X4	YFM350FXT - N	F	Complete	610.YA8306	610.YA8306	600.BT702A	600.BT702J
1995-2000	4X4	YFM350	F	Complete	610.YA8307	610.YA8307	600.BT702A	600.BT702J
400 BIG BEAR								
2012	4X4	YFM40FBBGR/FBBL/FBHB	F	Complete	610.YA8125	TBA	600.BT702A	600.BT3068G
	4X4	YFM40FBBGR/FBBL/FBHB	R	Complete	610.YA8334	610.YA8335	600.BT702A	600.BT702J
2007-2011	4X4	YFM40FBAGR/FBAL/FBHA	F	Complete	610.YA8125	610.YA8225	600.BT702A	600.BT3068G
	4X4	YFM40FBAGR/FBAL/FBHA	R	Complete	610.YA8334	610.YA8335	600.BT702A	600.BT702J
2002-2006	4X4	YFM400F	F	Complete	610.YA8310	610.YA8310	600.BT702A	600.BT701G
2001	4X4	YFM400FN / 40FHN	F	Complete	610.YA8307	610.YA8307	600.BT702A	600.BT702J
2000	4X4	YFM400FM / FMC	F	Complete	610.YA8307	610.YA8307	600.BT702A	600.BT702J
400 GRIZZLY								
2008	4X4	YFM400FGHX/FGX/FGXB	F	Complete	610.YA8309	610.YA8309	600.BT702A	600.BT701G
	4X4	YFM400FGHX/FGX/FGXB	R	Complete	610.YA8333	610.YA8333	600.BT702A	600.BT702J
2007	4X4	YFM400FGW	F	Complete	610.YA8309	610.YA8309	600.BT702A	600.BT701G
	4X4	YFM400FGW	R	Complete	610.YA8313	610.YA8313	600.BT702A	600.BT702J
400 KODIAK								
2005-2006	4X4	YFM400FAV	F	Complete	610.YA8309	610.YA8309	600.BT702A	600.BT701G
	4X4	YFM400FAV	R	Complete	610.YA8313	610.YA8313	600.BT702A	600.BT702J
2003-2004	4X4	YFM400FA	F	Complete	610.YA8309	610.YA8309	600.BT702A	600.BT701G
2000-2002	4X4	YFM400FA	F	Complete	610.YA8308	610.YA8308	600.BT702A	600.BT701G
1999	4X4	YFM400FWBL/BLC	F	Complete	610.YA8307	610.YA8307	600.BT702A	600.BT702J
1993-1998	4X4	YFM400FW	F	HalfShaft	610.YA7303	610.YA7303	600.BT702A	600.BT701G
450 GRIZZLY								
2008-2010	4X4	YFM45FGZGR/FGZGR/FGZL/FGHZ	F	Complete	610.YA8126	610.YA8226	600.BT702A	600.BT3068G
	4X4	YFM45FGZGR/FGZGR/FGZL/FGHZ	R	Complete	610.YA8333	610.YA8333	600.BT702A	600.BT702J
2007	4X4	YFM450FGW	F	Complete	610.YA8105	610.YA8205	600.BT702A	600.BT701G
	4X4	YFM450FGW	R	Complete	610.YA8313	610.YA8313	600.BT702A	600.BT702J
450 KODIAK								
2005-2007	4X4	YFM450FGW / FAV / FAT	F	Complete	610.YA8105	610.YA8205	600.BT702A	600.BT702J

ATV/UTV CV AXLES & BOOT KITS



Yamaha (continued)

Year(s)	DT	Model	Location	Type	Left Side CV	Right Side CV	Outboard CV Boot	Inboard CV Boot
	4X4	YFM450FGW / FAV / FAT	R	Complete	610.YA8313	610.YA8313	600.BT702A	600.BT702J
2004	4X4	YFM450FAS	F	Complete	610.YA8105	610.YA8205	600.BT702A	600.BT702J
2003	4X4	YFM450FAR	F	Complete	610.YA8105	610.YA8205	600.BT702A	600.BT702J
450 RHINO								
2006-2009	4X4	YXR450FYGR / FX / FH / FA	F	Complete	610.YA8121	610.YA8221	600.BT2075B	600.BT3068G
	4X4	YXR450FYGR / FX / FH / FA	R	Complete	610.YA8322	610.YA8323	600.BT2075B	600.BT2069K
WOLVERINE								
2006-2010	4X4	YFM450FX	F	Complete	610.YA8309	610.YA8309	600.BT702A	600.BT701G
550 GRIZZLY								
2009-2011	4X4	YFM5FG	F	Complete	610.YA8300	610.YA8300	600.BT2075A	600.BT2069L
	4X4	YFM5FG	R	Complete	610.YA8331	610.YA8331	600.BT2075A	600.BT2069H
	4X4	YFM5FG / GP - EPS	F	Complete	610.YA8300	610.YA8300	600.BT2075A	600.BT2069L
	4X4	YFM5FG / GP - EPS	R	Complete	610.YA8331	610.YA8331	600.BT2075A	600.BT2069H
660 GRIZZLY								
2003-2008	4X4	YRM660FG / FA / FS / FR	F	Complete	610.YA8111	610.YA8211	600.BT702A	600.BT3068G
	4X4	YRM660FG / FA / FS / FR	R	Complete	610.YA8301	610.YA8302	600.BT702A	600.BT702J
660 RHINO								
2006-2007	4X4	YXR660FW / FA	F	Complete	610.YA8121	610.YA8221	600.BT2075B	600.BT3068G
	4X4	YXR660FW / FA	R	Complete	610.YA8322	610.YA8323	600.BT2075B	600.BT2069K
700 GRIZZLY								
2007-2010	4X4	YFM700FGW-P	F	Complete	610.YA8300	610.YA8300	600.BT2075A	600.BT2069L
	4X4	YFM700FGW-P	R	Complete	610.YA8331	610.YA8331	600.BT2075A	600.BT2069H
700 RHINO								
2008-2013	4X4	YXR7FD / FB / FA / FS	F	Complete	610.YA8319	610.YA8319	600.BT2075B	600.BT2069L
	4X4	YXR7FD / FB / FA / FS	R	Complete	610.YA8329	610.YA8330	600.BT2075B	600.BT2069K
700 VIKING								
2014	4X4	Viking 700	F	Complete	610.YA8305	610.YA8305		
	4X4	Viking 700	R	Complete	610.YA8355	610.YA8355		

UNIVERSAL C.V. BOOT KIT



ATV City Part No.

Model

600.AB001

C.V.Boot Kit - Universal with clips & grease

AXLES

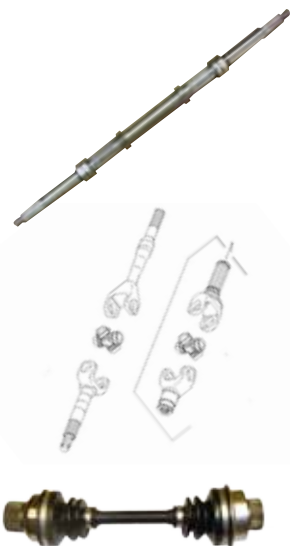

Axles

ATV City Part No.	Model
125.0001	Honda TRX250 97-13 OEM 42311-HM8-000
125.0005	Honda TRX300 88-00
125.0007	Honda TRX350 00-06 OEM 42311-HN5-672
125.0010	Honda TRX420 - Long Outer Spline OEM 42310-HP5-600
125.0015	Honda TRX400FW/450 S/ES 98-04 OEM 42300-HM7-A02
125.0075	Honda TRX500 01-09 OEM 42311-HN2-020
125.0210	Suzuki LTF250 Ozark OEM 64711-05G10
610.KW1119	Kawasaki Mule 3010/4010 Rear Inner Drive Shaft OEM REF 39158-1119
610.KW1120	Kawasaki Mule 3010/4010 Rear Outer Drive Shaft 39158-1120
610.YA9300	Yamaha YFM660 Grizzly Front Drive Shaft 03-08 OEM REF# 5KM-46173-10-00

AXLE HUBS



Axle Hubs

ATV City Part No.	Model
125.0110	Honda TRX350/400/450/500 Rear Left Hand Hub OEM 42620-HM7/HNO
125.0115	Honda TRX350/400/450/500 Rear Right Hand Hub OEM 42610-HM7/HNO
125.0120	Honda TRX300 / 420 Long Spline Rear Hub
125.0150	Yamaha YFM350/450 OEM 5ND-F5383-11-00

AXLE NUTS



Axle Nuts

ATV City Part No.	Model
100.0100	Outer axle nut Honda OEM 90307-HM5
100.0105	Inner axle nut Honda OEM 90308-HM5
100.0110	Outer axle / hub nut TRX300/350/400/450/500 M20 x 1.0



GATES CVT DRIVE BELTS

Arctic Cat

Application	Eng Size	Year	Mfr Part No	ATV City P/N
50	49cc	2006	3303537	225.73G2644
50	49cc	2005-2004	3301113	225.67G3470
50 Automatic	50cc	2008	3303537	225.73G2644
90	81cc	2005-2004	3301756	225.73G2644
90	89cc	2004-2002	3301113	225.67G3470
90	90cc	2013-2010	3303095	225.70G2809
90	90cc	2008-2006	3303095	225.70G2809
90 DVX	90cc	2012-2010	3303095	225.70G2809
90 DVX SE	90cc	2009	3303095	225.70G2809
90 SE	90cc	2009	3303095	225.70G2809
250	249cc	2009-2006	3303782	225.98G3541
300	270cc	2013-2010	3303782	225.98G3541
300 DVX	270cc	2013-2009	3303782	225.98G3541
350	366cc	2012-2011	0823228	225.11G3218
366	366cc	2009-2008	0823228	225.11G3218
366 SE	366cc	2011-2010	0823228	225.11G3218
375 Automatic	376cc	2002	3402664	225.13G3218
400 Automatic	376cc	2008-2003	3402664	225.13G3218
400 Automatic ACT	376cc	2004-2003	3402664	225.13G3218
400 Automatic ACT MRP	376cc	2004	3402664	225.13G3218
400 Automatic LE	376cc	2007-2005	3402664	225.13G3218
400 Automatic MRP	376cc	2004-2003	3402664	225.13G3218
400 Automatic TBX	376cc	2006-2004	3402664	225.13G3218
400 Automatic TRV	376cc	2007-2006	3402664	225.13G3218
400 Automatic VP	376cc	2006-2005	3402664	225.13G3218
400 Core	366cc	2013	0823228	225.11G3218
400 DVX	398cc	2005	3402664	225.13G3218
425	443cc	2012-2011	0823228	225.11G3218
425 SE	443cc	2012	0823228	225.11G3218
450	443cc	2012-2011	0823228	225.11G3218
450 Core	443cc	2013	0823228	225.11G3218
450 GT	443cc	2012	0823228	225.11G3218
450 H1 EFI	443cc	2010	0823228	225.11G3218
450 LTD	443cc	2011	0823228	225.11G3218
500	493cc	2009	3402757	225.44G3569
500 Automatic	493cc	2008-2000	3402757	225.44G3569
500 Automatic LE	493cc	2006-2005	3402757	225.44G3569
500 Automatic M4	493cc	2008	3402757	225.44G3569
500 Automatic MRP	493cc	2004-2003	3402757	225.44G3569
500 Automatic TBX	493cc	2006-2002	3402757	225.44G3569
500 Automatic TRV	493cc	2008	3402757	225.44G3569



GATES CVT DRIVE BELTS

Arctic Cat (Continued)

Application	Eng Size	Year	Mfr Part No	ATV City P/N
500 Automatic TRV	493cc	2006-2004	3402757	225.44G3569
500 Core	443cc	2013	0823228	225.11G3218
500 XT	443cc	2013	0823228	225.11G3218
500i Automatic	493cc	2003-2002	3402757	225.44G3569
550	545cc	2013-2011	0823013	225.46G3569
550 GT	545cc	2012	0823013	225.46G3569
550 H1 EFI	545cc	2010-2009	0823013	225.46G3569
550 H1 EFI LE	545cc	2010-2009	0823013	225.46G3569
550 LTD	545cc	2013-2011	0823013	225.46G3569
550 S	545cc	2011	0823013	225.46G3569
550 XT	545cc	2013	0823013	225.46G3569
650	641cc	2011	0823013	225.46G3569
650 H1	641cc	2010	0823013	225.46G3569
650 H1 Automatic	641cc	2008-2007	0823013	225.46G3569
650 H1 Automatic	641cc	2005	0823013	225.46G3569
650 H1 Automatic LE	641cc	2007	0823013	225.46G3569
650 H1 Automatic TBX	641cc	2007	0823013	225.46G3569
650 H1 Automatic TRV	641cc	2008-2007	0823013	225.46G3569
650 H1 SE	641cc	2006	0823013	225.46G3569
650 H1 TRV LE	641cc	2007	0823013	225.46G3569
650 TBX	641cc	2009	0823013	225.46G3569
700	695cc	2012-2011	0823013	225.46G3569
700 Core	695cc	2013	0823013	225.46G3569
700 Diesel	686cc Diesel	2007	1402564	225.37G3672
700 Diesel (Alt Belt)	686cc Diesel	2007	3206042	
700 EFI Automatic	695cc	2008-2007	3403141	225.43G3596
700 EFI Automatic	695cc Diesel	2008	1402564	225.37G3672
700 EFI Automatic (Alt Belt)	695cc Diesel	2008	3206042	
700 EFI Automatic LE	695cc	2007	3403141	225.43G3596
700 EFI Automatic M4	695cc	2008	3403141	225.43G3596
700 EFI Automatic TRV LE	695cc	2008	3403141	225.43G3596
700 EFI SE	695cc	2006	3403141	225.43G3596
700 GT	695cc	2012	0823013	225.46G3569
700 H1 EFI	695cc	2010-2009	0823013	225.46G3569
700 H1 EFI 4x4 Auto SE	695cc	2008	0823013	225.46G3569
700 H1 EFI LE	695cc	2010-2009	0823013	225.46G3569
700 H1 EFI Mudpro	695cc	2009	0823013	225.46G3569
700 H1 EFI SE	695cc	2009	0823013	225.46G3569
700 LTD	695cc	2013-2011	0823013	225.46G3569
700 S	695cc	2011	0823013	225.46G3569



GATES CVT DRIVE BELTS

Arctic Cat (Continued)

Application	Eng Size	Year	Mfr Part No	ATV City P/N
700 XT	695cc	2013	0823013	225.46G3569
1000 GT	951cc	2012-2011	0823231	225.46G3596
1000 LTD	951cc	2011	0823231	225.46G3596
1000 XT	951cc	2013	0823231	225.46G3596
DVX 50	49cc	2006	3303537	225.73G2644
DVX 50	50cc	2008	3303537	225.73G2644
DVX 90	90cc	2013	3303095	225.70G2809
DVX 90	90cc	2008-2006	3303095	225.70G2809
DVX 250	249cc	2008-2006	3303782	225.98G3541
Mud Pro 650	641cc	2011	0823013	225.46G3569
Mud Pro 1000	951cc	2011	0823231	225.46G3596
MudPro 650 H1	641cc	2010	0823013	225.46G3569
MudPro 700	695cc	2012-2011	0823013	225.46G3569
MudPro 700 H1 EFI	695cc	2010	0823013	225.46G3569
MudPro 700 LTD	695cc	2013-2012	0823013	225.46G3569
MudPro 1000 H2 EFI	951cc	2010	0823231	225.46G3596
MudPro 1000 LTD	951cc	2013-2012	0823231	225.46G3596
TBX 700 H1 EFI	695cc	2010	0823013	225.46G3569
Thundercat 4x4 Auto SE	950cc	2008	0823231	225.46G3596
Thundercat 950 Automatic	950cc	2008	0823231	225.46G3596
Thundercat 1000 H2	951cc	2010-2009	0823231	225.46G3596
Thundercat 1000 H2 LE	951cc	2010	0823231	225.46G3596
TRV 400	366cc	2009	0823228	225.11G3218
TRV 400 Core	366cc	2013	0823228	225.11G3218
TRV 400 H1	366cc	2010	0823228	225.11G3218
TRV 450	443cc	2012-2011	0823228	225.11G3218
TRV 450 GT	443cc	2012	0823228	225.11G3218
TRV 500 Core	443cc	2013	0823228	225.11G3218
TRV 550	545cc	2011	0823013	225.46G3569
TRV 550 Cruiser	545cc	2012-2011	0823013	225.46G3569
TRV 550 GT	545cc	2012-2011	0823013	225.46G3569
TRV 550 H1 EFI	545cc	2010-2009	0823013	225.46G3569
TRV 550 H1 EFI LE	545cc	2009	0823013	225.46G3569
TRV 550 LTD	545cc	2013	0823013	225.46G3569
TRV 550 XT	545cc	2013	0823013	225.46G3569
TRV 650 H1	641cc	2009	0823013	225.46G3569
TRV 700	695cc	2011	0823013	225.46G3569
TRV 700 Cruiser	695cc	2012-2011	0823013	225.46G3569



GATES CVT DRIVE BELTS

Arctic Cat (Continued)

Application	Eng Size	Year	Mfr Part No	ATV City P/N
TRV 700 GT	695cc	2012-2011	0823013	225.46G3569
TRV 700 H1 EFI	695cc	2010	0823013	225.46G3569
TRV 700 H1 EFI Cruiser	695cc	2010-2009	0823013	225.46G3569
TRV 700 LTD	695cc	2013	0823013	225.46G3569
TRV 700 XT	695cc	2013	0823013	225.46G3569
TRV 1000 Cruiser	951cc	2012-2011	0823231	225.46G3596
TRV 1000 GT	951cc	2012	0823231	225.46G3596
TRV 1000 H2 EFI	951cc	2010	0823231	225.46G3596
TRV 1000 H2 EFI Cruiser	951cc	2010-2009	0823231	225.46G3596
TRV 1000 LTD	951cc	2013	0823231	225.46G3596
XC 450	443cc	2012-2011	0823228	225.11G3218
XC 450	445cc	2013	0823228	225.11G3218

Bombardier

Application	Eng Size	Year	Mfr Part No	ATV City P/N
DS50	49cc	2006-2004	A23100117000	225.67G3470
DS50	50cc	2003	A23100117000	225.67G3470
DS90	83cc	2006-2005	A23100117000	225.67G3470
Outlander 330 HO	325cc	2005-2004	420280280	225.26G3628
Outlander 400	400cc	2003	420280280	225.26G3628
Outlander 400 HO	400cc	2006	715900024	225.26G3628
Outlander 400 HO	400cc	2005-2004	420280280	225.26G3628
Outlander 400 HO XT	400cc	2006	715900024	225.26G3628
Outlander 400 HO XT	400cc	2005	420280280	225.26G3628
Outlander 800 HO EFI	800cc	2006	420280360	225.30G3750
Outlander 800 HO EFI XT	800cc	2006	420280360	225.30G3750
Outlander MAX 400 HO	400cc	2006	715900024	225.26G3628
Outlander MAX 400 HO	400cc	2005-2004	420280280	225.26G3628
Outlander MAX 400 HO XT	400cc	2006	715900024	225.26G3628
Outlander MAX 400 HO XT	400cc	2005	420280280	225.26G3628
Outlander MAX 800 HO EFI	800cc	2006	420280360	225.30G3750
Quest 500	498cc	2004	420280280	225.26G3628
Quest 500	498cc	2003-2002	711280200	225.30G3636
Quest 650	644cc	2004	420280200	225.30G3636
Quest 650	644cc	2003	711280200	225.30G3636
Quest 650	644cc	2002	715900023	225.30G3636
Quest 650 XT	644cc	2004	420280200	225.30G3636



GATES CVT DRIVE BELTS

Bombardier (Continued)

Application	Eng Size	Year	Mfr Part No	ATV City P/N
Quest MAX 650	644cc	2004	420280200	225.30G3636
Traxter 500 Auto CVT	498cc	2005	715900024	225.26G3628
Traxter 650 Auto CVT	644cc	2005	715900024	225.26G3628
Traxter MAX	498cc	2003	715900023	225.30G3636
Traxter MAX 500	498cc	2005	715900023	225.30G3636
Traxter MAX 650 Auto CVT	644cc	2005	715900023	225.30G3636
Traxter XL	498cc	2003	715900023	225.30G3636
Traxter XT	498cc	2003	715900023	225.30G3636

Can-Am

Application	Eng Size	Year	Mfr Part No	ATV City P/N
DS 250	249cc	2013-2008	S1B01RB101	225.95G3021
Outlander 400 EFI	400cc	2013-2011	420280280	225.26G3628
Outlander 400 EFI	400cc	2010-2009	715900024	225.26G3628
Outlander 400 EFI XT	400cc	2013-2011	420280280	225.26G3628
Outlander 400 EFI XT	400cc	2010-2009	715900024	225.26G3628
Outlander 400 HO	400cc	2008-2007	715900024	225.26G3628
Outlander 400 HO XT	400cc	2008-2007	715900024	225.26G3628
Outlander 500 EFI	500cc	2013-2009	715000302	225.30G3750
Outlander 500 EFI XT	500cc	2013-2009	715000302	225.30G3750
Outlander 500 HO EFI	500cc	2008-2007	715900030	225.30G3750
Outlander 500 HO EFI XT	500cc	2008-2007	715900030	225.30G3750
Outlander 650 EFI	650cc	2013-2009	715000302	225.30G3750
Outlander 650 EFI XT	650cc	2013-2009	715000302	225.30G3750
Outlander 650 HO EFI	650cc	2008-2007	715900030	225.30G3750
Outlander 650 HO EFI XT	650cc	2008-2007	715900030	225.30G3750
Outlander 800 HO EFI	800cc	2008	715000302	225.30G3750
Outlander 800 HO EFI	800cc	2007	715900030	225.30G3750
Outlander 800 HO EFI XT	800cc	2008	715000302	225.30G3750
Outlander 800 HO EFI XT	800cc	2007	715900030	225.30G3750
Outlander 800R EFI	800cc	2013-2009	715000302	225.30G3750
Outlander 800R EFI X MR	800cc	2012-2010	715000302	225.30G3750
Outlander 800R EFI X XC	800cc	2011-2010	715000302	225.30G3750
Outlander 800R EFI XT	800cc	2013-2009	715000302	225.30G3750
Outlander 1000 EFI	976cc	2013-2012	715000302	225.30G3750
Outlander 1000 EFI XT	976cc	2013-2012	715000302	225.30G3750
Outlander Max 400 HO	400cc	2008-2007	715900024	225.26G3628
Outlander Max 500 HO EFI	500cc	2008-2007	715900030	225.30G3750
Outlander Max 500 HO EFI XT	500cc	2008-2007	715900030	225.30G3750
Outlander Max 650 HO EFI	650cc	2008-2007	715900030	225.30G3750
Outlander Max 650 HO EFI XT	650cc	2008-2007	715900030	225.30G3750



GATES CVT DRIVE BELTS

CF Moto

Application	Eng Size	Year	Mfr Part No	ATV City P/N
Terralander 800 EFI	800cc	2013-2011	800055000	225.40G3569
Trail Tracker 600 EFI	594cc	2013-2011	180055000	225.40G3691
Trail Tracker EX 500 EFI	493cc	2013-2011	180055000	225.40G3691
Trail Tracker EX 600 EFI	594cc	2013-2011	180055000	225.40G3691

Kawasaki

Application	Eng Size	Year	Mfr Part No	ATV City P/N
Brute Force 650 4x4	633cc	2013	590110003	225.19G3218
Brute Force 650 4x4	633cc	2011-2005	590110003	225.19G3218
Brute Force 650 4x4i	633cc	2013-2011	590110003	225.19G3218
Brute Force 650 4x4i	633cc	2009-2007	590110003	225.19G3218
Brute Force 750 4x4i	749cc	2013-2012	590110019	225.13G3218
Brute Force 750 4x4i	749cc	2011-2005	590110003	225.19G3218
Brute Force 750 4x4i Realtree Hardwoods Green HD	749cc	2010	590110003	225.19G3218
KFX80	82cc	2006-2003	590115003	225.69G2919
KFX700	697cc	2009-2004	590110003	225.19G3218
KFX700 IG	697cc	2006-2004	590110003	225.19G3218
Prairie 300	290cc	2002-1999	590111065	225.23G3805
Prairie 360	362cc	2009-2008	590110003	225.19G3218
Prairie 360	362cc	2007	590110003	225.19G3218
Prairie 360	362cc	2006-2004	590110003	225.19G3218
Prairie 360	362cc	2003	590111084	225.19G3218
Prairie 360 4x4	362cc	2013-2010	590110003	225.19G3218
Prairie 360 4x4 Realtree Hardwoods Green HD	362cc	2011-2010	590110003	225.19G3218
Prairie 400	391cc	2002-1999	590111066	225.23G3935
Prairie 400	391cc	1998	590111060	225.29G4077
Prairie 400 4x4	391cc	1997	590111060	225.29G4077
Prairie 650	633cc	2002	590111080	225.19G3218
Prairie 650 4x4	633cc	2003	590111080	225.19G3218





GATES CVT DRIVE BELTS

Polaris

Application	Eng Size	Year	Mfr Part No	ATV City P/N
300	283cc	1995-1994	3211077	225.20G4022
400L	378cc	1995-1994	3211077	225.20G4022
ATP 330	329cc	2005-2004	3211077	225.20G4022
ATP 500 HO	499cc	2005-2004	3211069	225.19G4006E
Big Boss 4x6	244cc	1992-1989	3211077	225.20G4022
Big Boss 6x6	244cc	1992-1991	3211077	225.20G4022
Big Boss 250 6x6	244cc	1993	3211077	225.20G4022
Big Boss 300 6x6	283cc	1994	3211077	225.20G4022
Big Boss 350L 6x6	352cc	1993	3211077	225.20G4022
Big Boss 400L 6x6	378cc	1997-1994	3211077	225.20G4022
Big Boss 500 6x6 (W/EBS)	499cc	1999-1998	3211069	225.19G4006E
Big Boss 500 6x6 (W/O EBS)	499cc	1999-1998	3211077	225.20G4022
Cyclone	244cc	1987	3211077	225.20G4022
Diesel	455cc Diesel	2001-1999	3211069	225.19G4006E
Hawkeye 300	299cc	2007-2006	3211108	225.38G4266
Magnum 4x4	425cc	1997	3211077	225.20G4022
Magnum 6x6	425cc	1997-1996	3211077	225.20G4022
Magnum 325 (W/EBS)	325cc	2002-2000	3211069	225.19G4006E
Magnum 325 (W/O EBS)	325cc	2002-2000	3211077	225.20G4022
Magnum 330	329cc	2006-2005	3211077	225.20G4022
Magnum 330 (W/EBS)	329cc	2004-2003	3211069	225.19G4006E
Magnum 330 (W/O EBS)	329cc	2004-2003	3211077	225.20G4022
Magnum 425	425cc	1997-1995	3211077	225.20G4022
Magnum 425 (W/EBS)	425cc	1998	3211069	225.19G4006E
Magnum 425 (W/O EBS)	425cc	1998	3211077	225.20G4022
Magnum 500	499cc	2002-2001	3211069	225.19G4006E
Magnum 500	499cc	1999	3211069	225.19G4006E
Magnum 500 4x4 HDS	499cc	2003	3211069	225.19G4006E
Magnum 500 (W/EBS)	499cc	2000	3211069	225.19G4006E
Magnum 500 (W/O EBS)	499cc	2000	3211077	225.20G4022
Predator 90	89cc	2006-2003	450239	225.67G3470
Scrambler	244cc	1986-1985	3211077	225.20G4022
Scrambler	378cc	1996-1995	3211077	225.20G4022
Scrambler 90	89cc	2003-2001	450239	225.67G3470
Scrambler 400	378cc	1999-1998	3211077	225.20G4022
Scrambler 400 2x4	378cc	2002-2000	3211077	225.20G4022
Scrambler 400 4x4	378cc	2002-2000	3211077	225.20G4022
Scrambler 400L	378cc	1997	3211077	225.20G4022
Scrambler 500	498cc	2000	3211077	225.20G4022
Scrambler 500	499cc	2009-2003	3211077	225.20G4022
Scrambler 500	499cc	2001	3211077	225.20G4022
Scrambler 500	499cc	1999-1997	3211077	225.20G4022



GATES CVT DRIVE BELTS

Polaris (Continued)

Application	Eng Size	Year	Mfr Part No	ATV City P/N
Scrambler 500 2x4	499cc	2002	3211077	225.20G4022
Scrambler 500 4x4	498cc	2012-2010	3211077	225.20G4022
Scrambler 500 4x4	499cc	2002	3211077	225.20G4022
Scrambler XP 850 HO	850cc	2013	3211123	225.23G3836
Sport 400	378cc	2001	3211077	225.20G4022
Sport 400	378cc	1999-1998	3211077	225.20G4022
Sport 400L	378cc	1997-1994	3211077	225.20G4022
Sportsman 4x4	378cc	1997-1994	3211077	225.20G4022
Sportsman 90	89cc	2006-2002	0450239	225.67G3470
Sportsman 300	298cc	2010	3211131	225.38G4266
Sportsman 300	299cc	2009-2008	3211131	225.38G4266
Sportsman 335	334cc	2001-1998	3211077	225.20G4022
Sportsman 400	425cc	2005-2002	3211077	225.20G4022
Sportsman 400 HO	455cc	2013	3211077	225.20G4022
Sportsman 400 HO	455cc	2012-2011	3211077	225.20G4022
Sportsman 400 HO	455cc	2010-2008	3211131	225.38G4266
Sportsman 450	455cc	2007-2006	3211077	225.20G4022
Sportsman 500	499cc	1997-1996	3211077	225.20G4022
Sportsman 500 6x6	499cc	2008-2000	3211077	225.20G4022
Sportsman 500 (W/EBS)	499cc	2001-1998	3211069	225.19G4006E
Sportsman 500 (W/O EBS)	499cc	2001-1998	3211077	225.20G4022
Sportsman 500 EFI	499cc	2009-2008	3211113	225.19G3982
Sportsman 500 EFI	499cc	2007	3211077	225.20G4022
Sportsman 500 EFI	499cc	2006	3211091	225.19G3982E
Sportsman 500 EFI Touring	499cc	2009-2008	3211113	225.19G3982
Sportsman 500 EFI X2	499cc	2009-2008	3211113	225.19G3982
Sportsman 500 HO	498cc	2013	3211077	225.20G4022
Sportsman 500 HO	498cc	2012-2009	3211077	225.20G4022
Sportsman 500 HO	499cc	2008	3211077	225.20G4022
Sportsman 500 HO	499cc	2006	3211077	225.20G4022
Sportsman 500 HO	499cc	2005-2003	3211095	225.20G4022E
Sportsman 500 HO (W/EBS)	499cc	2002	3211069	225.19G4006E
Sportsman 500 HO (W/O EBS)	499cc	2002	3211077	225.20G4022
Sportsman 500 X2	499cc	2007	3211113	225.19G3982
Sportsman 550	549cc	2012-2010	3211123	225.23G3836
Sportsman 550 EPS	549cc	2012-2010	3211123	225.23G3836
Sportsman 600 Twin	597cc	2005-2003	3211091	225.19G3982E
Sportsman 700 EFI	683cc	2007	3211116	225.20G3982
Sportsman 700 EFI	683cc	2006	3211091	225.19G3982E
Sportsman 700 EFI X2	683cc	2008	3211113	225.19G3982
Sportsman 700 Military Vehicle	683cc	2005	3211091	225.19G3982E
Sportsman 700 Twin	683cc	2006-2002	3211091	225.19G3982E
Sportsman 700 Twin EFI	683cc	2005-2004	3211091	225.19G3982E



GATES CVT DRIVE BELTS

Polaris (Continued)

Application	Eng Size	Year	Mfr Part No	ATV City P/N
Sportsman 800 EFI	760cc	2013-2008	3211113	225.19G3982
Sportsman 800 EFI	760cc	2007	3211116	225.20G3982
Sportsman 800 EFI	760cc	2006	3211106	225.19G4022
Sportsman 800 EFI Touring	760cc	2009-2008	3211113	225.19G3982
Sportsman 800 EFI X2	760cc	2009-2007	3211113	225.19G3982
Sportsman 800 Twin EFI	760cc	2005	3211106	225.19G4022
Sportsman Big Boss 6x6 800	760cc	2013-2009	3211113	225.19G3982
Sportsman MV7	683cc	2006	3211091	225.19G3982E
Sportsman Touring 500 HO	498cc	2013-2010	3211113	225.19G3982
Sportsman Touring 550 EPS	549cc	2012-2010	3211123	225.23G3836
Sportsman Touring 850 EPS	850cc	2013-2010	3211123	225.23G3836
Sportsman X2 500	499cc	2006	3211091	225.19G3982E
Sportsman X2 550	549cc	2012-2010	3211123	225.23G3836
Sportsman X2 850 LE	850cc	2011	3211123	225.23G3836
Sportsman XP 550 EFI	549cc	2009	3211123	225.23G3836
Sportsman XP 850	850cc	2013-2010	3211123	225.23G3836
Sportsman XP 850 EFI	850cc	2009	3211123	225.23G3836
Sportsman XP 850 EPS	850cc	2012-2010	3211123	225.23G3836
Trail Blazer	244cc	2002-1997	3211077	225.20G4022
Trail Blazer	244cc	1995-1990	3211077	225.20G4022
Trail Blazer 250	244cc	2006-2003	3211077	225.20G4022
Trail Blazer 330	329cc	2013-2008	3211077	225.20G4022
Trail Blazer 400	378cc	2003	3211077	225.20G4022
Trail Blazer ES	244cc	1997-1996	3211077	225.20G4022
Trail Boss	244cc	1987-1985	3211077	225.20G4022
Trail Boss	325cc	2002-2001	3211077	225.20G4022
Trail Boss 250	244cc	1999-1988	3211077	225.20G4022
Trail Boss 325	325cc	2000	3211077	225.20G4022
Trail Boss 330	329cc	2013-2003	3211077	225.20G4022
Trail Boss 350L	350cc	1991-1990	3211077	225.20G4022
Trail Boss 350L	352cc	1993-1992	3211077	225.20G4022
X2 500 EFI	499cc	2007	3211113	225.19G3982
X2 800 EFI	760cc	2007	3211113	225.19G3982
Xplorer	244cc	2002-2000	3211077	225.20G4022
Xplorer 300	283cc	1999-1996	3211077	225.20G4022
Xplorer 400	378cc	2002-1998	3211077	225.20G4022
Xplorer 400L	378cc	1997-1995	3211077	225.20G4022
Xplorer 500	499cc	1997	3211077	225.20G4022
Xpress 300	283cc	1999-1996	3211077	225.20G4022
Xpress 400L	378cc	1997-1996	3211077	225.20G4022

Bearings

Braking

Bulbars

Cables

Carburettor

Driveline

Electrical

Exhausts



GATES CVT DRIVE BELTS

Suzuki

Application	Eng Size	Year	Mfr Part No	ATV City P/N
Eiger Auto 400	376cc	2007-2002	2760138F00	225.19G3218
King Quad 400	376cc	2013-2008	2760138F00	225.19G3218
King Quad 450	454cc	2010-2007	2760111H00	225.27G3450
King Quad 500	493cc	2013-2011	2760111H00	225.27G3450
King Quad 500	493cc	2009	2760111H00	225.27G3450
King Quad 700	695cc	2007-2005	2760131G00	225.43G3596
King Quad 750	722cc	2013-2011	2760131G00	225.43G3596
King Quad 750	722cc	2009-2008	2760131G00	225.43G3596
QuadRunner	82cc	1992-1987	2760140B01	225.69G2919
QuadRunner	493cc	2001-2000	2760109F51	225.44G3569
QuadSport 80	82cc	2006-2005	2760138F00	225.19G3218
QuadSport 80	82cc	2004-1993	2760140B01	225.69G2919
Twin Peaks 700	697cc	2005-2004	K590110003	225.13G3218
Vinson 500	493cc	2002	2760109F60	225.44G3569
Vinson Auto 500	493cc	2007-2003	2760109F60	225.44G3569

Yamaha

Application	Eng Size	Year	Mfr Part No	ATV City P/N
Breeze	124cc	2004-1991	3FA176410000	225.78G3640
Bruin 350	348cc	2006-2004	5UH176410000	225.16G3332
Grizzly	595cc	1999-1998	4WV176410000	225.30G3596
Grizzly 125	124cc	2009-2004	3FA176410000	225.78G3640
Grizzly 125 Automatic	124cc	2013-2010	3FA176410000	225.78G3640
Grizzly 350 Auto 4x4	348cc	2013-2008	5UH176410100	225.16G3332
Grizzly 350 Auto 4x4	348cc	2007	5UH176410000	225.16G3332
Grizzly 350 Auto 4x4 IRS	348cc	2011-2008	5UH176410100	225.16G3332
Grizzly 350 Auto 4x4 IRS	348cc	2007	5UH176410000	225.16G3332
Grizzly 350 Automatic	348cc	2011-2008	5UH176410100	225.16G3332
Grizzly 350 Automatic	348cc	2007	5UH176410000	225.16G3332
Grizzly 400 Automatic	401cc	2008	5GH176411000	225.19G3242
Grizzly 400 Automatic	401cc	2007	5GH176410000	225.19G3242
Grizzly 450 Auto 4x4	421cc	2013-2010	5GH176411000	225.19G3242
Grizzly 450 Auto 4x4	421cc	2008	5GH176411000	225.19G3242
Grizzly 450 Auto 4x4	421cc	2007	5GH176410000	225.19G3242
Grizzly 450 Auto 4x4 EPS	421cc	2013-2010	5GH176411000	225.19G3242
Grizzly 450 Automatic	421cc	2009-2008	5GH176411000	225.19G3242
Grizzly 450 Automatic	421cc	2007	5GH176410000	225.19G3242
Grizzly 550 Automatic	558cc	2009	28P176410000	225.29G3596
Grizzly 550 FI Auto 4x4	558cc	2013-2010	28P176410000	225.29G3596
Grizzly 550 FI Auto 4x4 EPS	558cc	2013-2010	28P176410000	225.29G3596
Grizzly 600	595cc	2001-2000	4WV176410000	225.30G3596
Grizzly 660	660cc	2003-2002	5KM176410000	225.29G3596



GATES CVT DRIVE BELTS

Yamaha(Continued)

Application	Eng Size	Year	Mfr Part No	ATV City P/N
Grizzly 660 Automatic	660cc	2008	5KM176410100	225.29G3596
Grizzly 660 Automatic	660cc	2007-2004	5KM176410000	225.29G3596
Grizzly 700 FI Auto 4x4	686cc	2013-2011	28P176410000	225.29G3596
Grizzly 700 FI Auto 4x4	686cc	2010-2007	3B4176410000	225.29G3596
Grizzly 700 FI Auto 4x4 EPS	686cc	2013-2011	28P176410000	225.29G3596
Grizzly 700 FI Auto 4x4 EPS	686cc	2010-2008	3B4176410000	225.29G3596
Grizzly 700 FI Auto 4x4 EPS SE	686cc	2013-2011	28P176410000	225.29G3596
Grizzly 700 FI Auto 4x4 EPS SE	686cc	2010-2009	3B4176410000	225.29G3596
Kodiak 400	401cc	2003-2000	5GH176410000	225.19G3242
Kodiak 400 Automatic	401cc	2006-2004	5GH176410000	225.19G3242
Kodiak 450	449cc	2003	5GH176410000	225.19G3242
Kodiak 450 Automatic	421cc	2006	5GH176410000	225.19G3242
Kodiak 450 Automatic	449cc	2005-2004	5GH176410000	225.19G3242
Wolverine 350	348cc	2009-2008	5UH176410100	225.16G3332
Wolverine 350	348cc	2007-2006	5UH176410000	225.16G3332

UTVs



Arctic Cat, Inc

Application	Eng Size	Year	Mfr Part No	ATV City P/N
650 H1 Prowler	641cc	2008-2007	0823013	225.46G3569
650 H1 Prowler M4	641cc	2008	0823013	225.46G3569
650 H1 Prowler XT	641cc	2008-2006	0823013	225.46G3569
700 Prowler XTX LE	695cc	2008	0823013	225.46G3569
Prowler 550 H1 EFI	545cc	2009	0823013	225.46G3569
Prowler HDX 700	695cc	2013-2011	0823013	225.46G3569
Prowler XT 550	545cc	2013-2010	0823013	225.46G3569
Prowler XT 650 H1	641cc	2009	0823013	225.46G3569
Prowler XTX 700	695cc	2013-2010	0823013	225.46G3569
Prowler XTX 700 H1 EFI	695cc	2009	0823013	225.46G3569
Prowler XTX 700 H1 EFI LE	695cc	2009	0823013	225.46G3569
Prowler XTZ 1000	951cc	2013-2010	0823231	225.46G3596
Prowler XTZ 1000 H2 EFI	951cc	2009	0823231	225.46G3596
Super Duty Diesel 700	686cc Diesel	2013-2010	01402564	225.37G3672
TBX 700 GT	695cc	2012	0823013	225.46G3569
TBX 700 LTD	695cc	2011	0823013	225.46G3569
TBX 700 XT	695cc	2013	0823013	225.46G3569
Wildcat 1000 HO	951cc	2013-2012	0823231	225.46G3596
Wildcat 1000 HO Limited	951cc	2013	0823231	225.46G3596



GATES CVT DRIVE BELTS

UTVs

Argo

Application	Eng Size	Year	Mfr Part No	ATV City P/N
700 HD 8x8	674cc	2012-2010	127137	225.20G4154
750 HDi 8x8	748cc	2012-2010	127137	225.20G4154
Avenger 8x8	674cc	2007-2004	127137	225.20G4154
Avenger 700 8x8	674cc	2009-2008	127137	225.20G4154
Avenger 750 EFI 8x8	748cc	2009-2008	127137	225.20G4154
Avenger EFI 8x8	748cc	2007	127137	225.20G4154
Bigfoot 6x6	570cc	2007-2000	12556	225.48G5122
Conquest 6x6	617cc	2007-2003	12556	225.48G5122
Conquest 8x8	617cc	2007-2006	12556	225.48G5122
Conquest 8x8	620cc	2005-2000	12556	225.48G5122
Response 8x8	570cc	2007-2000	12556	225.48G5122
Vanguard 2 6x6	480cc	2007-2000	12556	225.48G5122
Vanguard 6x6	480cc	2007-2000	12556	225.48G5122

Can-Am

Application	Eng Size	Year	Mfr Part No	ATV City P/N
Commander 800R EFI	800cc	2013-2011	715000302	225.30G3750
Commander 800R EFI DPS	800cc	2013	715000302	225.30G3750
Commander 800R EFI XT	800cc	2013-2011	715000302	225.30G3750
Commander 1000 EFI	976cc	2012-2011	715000302	225.30G3750
Commander 1000 EFI Limited	976cc	2012	715000302	225.30G3750
Commander 1000 EFI X	976cc	2012-2011	715000302	225.30G3750
Commander 1000 EFI XT	976cc	2012-2011	715000302	225.30G3750

CF - Moto

Application	Eng Size	Year	Mfr Part No	ATV City P/N
Snyper 600 EFI	594cc	2013-2011	180055000	225.40G3691
Swat 500 CR	493cc	2013-2011	180055000	225.40G3691
Swat 600 EFI	594cc	2013-2011	180055000	225.40G3691

Cushman

Application	Eng Size	Year	Mfr Part No	ATV City P/N
Gator	617cc	2005-1993	M125383	225.24G5596
Gator	658cc Diesel	2004	M125383	225.24G5596



GATES CVT DRIVE BELTS

UTVs

John Deere

Application	Eng Size	Year	Mfr Part No	ATV City P/N
Gator RSX 850i	839cc	2013	M168196	225.23G4340
Gator RSX 850i Sport	839cc	2013	M168196	225.23G4340
Gator RSX 850i Trail	839cc	2013	M168196	225.23G4340
Gator RSX 850i XUV	850cc	2012	M168196	225.23G4340
Gator XUV 550	570cc	2012	M161702	225.28G4573
Gator XUV 550 S4	570cc	2012	M161702	225.28G4573
Gator XUV 825I	812cc	2012-2011	M158189	225.32G4588
Gator XUV 855D	854cc Diesel	2012-2011	M158189	225.32G4588
M-Gator A-2	854cc Diesel	2012	M158189	225.32G4588
Trail Gator	617cc	2005-1999	M125383	225.24G5596
Trail Gator	658cc Diesel	2006-2004	M125383	225.24G5596
Worksite Gator	617cc	2004-2001	M125383	225.24G5596

Kawasaki

Application	Eng Size	Year	Mfr Part No	ATV City P/N
Mule 600	401cc	2013-2005	590110011	225.03G3470
Mule 610 4x4	401cc	2013-2005	590110011	225.03G3470
Mule 610 4x4 Realtree APG HD	401cc	2010	590110011	225.03G3470
Mule 610 4x4 XC	401cc	2013-2010	590110011	225.03G3470
Mule 1000	454cc	1998-1995	590111053	225.24G4108
Mule 2010 4x4	540cc	1992-1990	590111053	225.24G4108
Mule 2020 2x4	540cc	1992-1990	590111053	225.24G4108
Mule 2030 Turf	540cc	1992-1990	590111053	225.24G4108
Mule 2500	617cc	2001-2000	590111070	225.20G4272
Mule 2500	617cc	1999-1994	590111057	225.27G4313
Mule 2510 4x4	617cc	2001-2000	590111070	225.20G4272
Mule 2510 4x4	617cc	1999-1995	590111057	225.27G4313
Mule 2510 Diesel	953cc Diesel	2003-2000	590111078	225.28G4313
Mule 2520	617cc	2003-2001	590111070	225.20G4272
Mule 2520 Turf	617cc	2000-1994	590111057	225.27G4313
Mule 3000	617cc	2008-2001	590111077	225.24G4108
Mule 3010 4x4	617cc	2008-2001	590111077	225.24G4108
Mule 3010 Trans 4x4	617cc	2008-2005	590111077	225.24G4108
Mule 3020	617cc	2003-2001	590111077	225.24G4108
Mule 4000	617cc	2013-2009	590111077	225.24G4108
Mule 4010 4x4	617cc	2013-2009	590111077	225.24G4108
Mule 4010 Trans 4x4	617cc	2013-2009	590111077	225.24G4108
Mule 4010 Trans 4x4 Realtree APG HD	617cc	2011-2010	590111077	225.24G4108
Teryx 750	749cc	2009-2008	590110019	225.13G3218
Teryx 750 4x4	749cc	2011-2010	590110019	225.13G3218



GATES CVT DRIVE BELTS

UTVs

Kawasaki (Continued)

Application	Eng Size	Year	Mfr Part No	ATV City P/N
Teryx 750 4x4 LE	749cc	2010	590110019	225.13G3218
Teryx 750 4x4 LE	749cc	2008	590110019	225.13G3218
Teryx 750 4x4 LE Realtree APG HD	749cc	2011-2010	590110019	225.13G3218
Teryx 750 4x4 NRA Outdoors	749cc	2008	590110019	225.13G3218
Teryx 750 FI 4x4	749cc	2013-2011	590110019	225.13G3218
Teryx 750 FI 4x4	749cc	2009-2008	590110019	225.13G3218
Teryx 750 FI 4x4 LE	749cc	2013-2011	590110019	225.13G3218
Teryx 750 FI 4x4 LE	749cc	2009	590110019	225.13G3218
Teryx 750 FI 4x4 LE Camo	749cc	2013-2012	590110019	225.13G3218
Teryx 750 FI 4x4 LE SGE	749cc	2012	590110019	225.13G3218
Teryx 750 FI 4x4 NRA Outdoors	749cc	2009	590110019	225.13G3218
Teryx 750 FI 4x4 Sport	749cc	2013-2009	590110019	225.13G3218
Teryx 750 Sport	749cc	2009	590110019	225.13G3218

Polaris

Application	Eng Size	Year	Mfr Part No	ATV City P/N
Ranger	425cc	2004-2000	3211077	225.20G4022
Ranger	455cc	2013-2010	3211077	225.20G4022
Ranger	498cc	2013-2011	3211113	225.19G3982
Ranger	498cc	2010	3211077	225.20G4022
Ranger	499cc	2009-1998	3211077	225.20G4022
Ranger	683cc	2009-2008	3211118	225.24G4022
Ranger	760cc	2013	3211133	225.24G4022
Ranger 6x6	760cc	2013-2010	3211133	225.24G4022
Ranger Crew	498cc	2013-2011	3211113	225.19G3982
Ranger Crew	683cc	2009-2008	3211118	225.24G4022
Ranger Crew	760cc	2013-2010	3211133	225.24G4022
Ranger Crew Diesel	904cc Diesel	2013-2012	3211135	225.33G3836
Ranger Crew EPS	760cc	2011	3211133	225.24G4022
Ranger Diesel	904cc Diesel	2013-2011	3211135	225.33G3836
Ranger HD	683cc	2009	3211118	225.24G4022
Ranger HD	760cc	2010	3211133	225.24G4022
Ranger HD EPS	760cc	2012-2011	3211133	225.24G4022
Ranger RZR	760cc	2012-2008	3211113	225.19G3982
Ranger RZR 4	760cc	2012	3211133	225.24G4022
Ranger RZR 4 EPS	760cc	2011	3211133	225.24G4022
Ranger RZR S	760cc	2012-2010	3211133	225.24G4022
Ranger RZR S	760cc	2009	3211130	225.19G4022
Ranger RZR SW	760cc	2012-2010	3211133	225.24G4022
Ranger RZR XP	875cc	2012	3211148	225.21G4140
Ranger RZR XP	875cc	2011	3211142	225.21G4140

GATES CVT DRIVE BELTS



UTVs

Polaris (Continued)

Application	Eng Size	Year	Mfr Part No	ATV City P/N
Ranger TM	653cc	2006-2004	3211101	225.33G4828
Ranger XP	683cc	2009-2008	3211118	225.24G4022
Ranger XP	683cc	2007-2005	3211106	225.19G4022
Ranger XP	760cc	2012-2010	3211133	225.24G4022
Ranger XP EPS	760cc	2012-2011	3211133	225.24G4022
RZR 4 800	760cc	2013	3211133	225.24G4022
RZR 800	760cc	2013	3211113	225.19G3982
RZR S 800	760cc	2013	3211133	225.24G4022
RZR XP 4 900	875cc	2013	3211148	225.21G4140
RZR XP 900	875cc	2013	3211148	225.21G4140
Worker 335	334cc	1999	3211077	225.20G4022
Worker 500	499cc	1999	3211077	225.20G4022
Worker 500 (W/EBS)	499cc	2001	3211069	225.19G4006E
Worker 500 (W/O EBS)	499cc	2001	3211077	225.20G4022

Yamaha

Application	Eng Size	Year	Mfr Part No	ATV City P/N
G11	301cc	2001	J55G62410000	225.24G3884
G21	357cc	2004-2001	J55G62410000	225.24G3884
Pro Hauler 700 Automatic	357cc	2006-2004	J55G62410000	225.24G3884
Pro Hauler 1000 Automatic	357cc	2005-2004	J55G62410000	225.24G3884
Rhino 450 Automatic	421cc	2009-2006	5GH176411000	225.19G3242
Rhino 660 Automatic	660cc	2008-2007	5KM176410100	225.29G3596
Rhino 660 Automatic	660cc	2006-2004	5KM176410000	225.29G3596
Rhino 700 Automatic	686cc	2011-2008	5B4176410000	225.26G3596
Rhino 700 FI Auto 4x4	686cc	2013-2012	5B4176410000	225.26G3596
U-Max	357cc	2008-2004	J55G62410000	225.24G3884



MV CITY®

the best part of your atv

- 1: BEARINGS, BUSH KITS, BALLJOINTS
- 2: BRAKING
- 3: BULLBARS, MUDFLAP KITS
- 4: CABLES
- 5: CARBURETTOR PARTS
- 6: DRIVE LINE / CVT BELTS / AXLES
- 7: ELECTRICAL
- 8: EXHAUSTS
- 9: MISCELLANEOUS
- 10: FILTERS
- 11: SEAT COVERS, OVER COVERS
- 12: TOOLS
- 13: TYRES / TUBES / RIMS
- 14: ENGINE COMPONENTS
- 15: SPRAYERS & SPRAYER ACCESSORIES



7: ELECTRICAL

BATTERIES

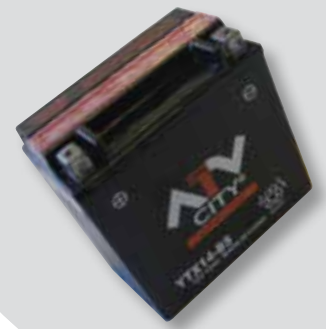

All batteries are covered by a 12 month manufacturer's warranty - conditions apply. All batteries come with acid packs

Motorcycle batteries

ATV City Part No.	Length	Width	Height	Terminal Layout
150.YTX14-BS	152	88	147	
150.YTX14AH-BS	136	91	168	
150.YTX12-BS	152	88	131	
150.YTX4L-BS	114	71	86	
150.YTX5L-BS	114	71	106	
150.YTX7A-BS	150	87	94	
150.YTX9-BS	152	88	107	
150.YTX20L-BS	175	87	155	
150.YTX20CH-BS	150	87	161	
150.YTX24HL-BS	205	87	161	
150.Y50N18A-A	206	91	177	
150.YB10L-A2	136	91	146	
150.YB12C-A	134	80	175	
150.YB14A-A1	134	89	176	
150.YB14A-A2	136	91	178	
150.YB14L-A2	135	90	167	
150.YB16CL-B	175	100	175	
150.YB30L-B	168	132	176	

Battery Pole Protector 200ml



Prevents sulfating of battery connectors and poles. Quick drying, it avoids the sticking on of dust and dirt. The blue colour makes it easy to control the points of application. Special formula which allows an easy dismantling of the battery.

P/N: 210.0065

BATTERY FITMENT CHART



Bearings

Braking

Bullbars

Cables

Carburettor

Driveline

Electrical

Exhausts

Aeon (Benzai)

ATV City Part No.	Year	Model
150.YTX4L-BS	152	Cobra/CX-Sport 50
150.YTX4L-BS	136	Cobra/CX-Sport 90
150.YTX4L-BS	152	Cobra/CX-Sport 100

Arctic Cat

ATV City Part No.	Year	Model
150.YTX4L-BS	All	All 90
150.YB14L-A2	All	All 250
150.YB14L-A2	All	All 300
150.YB14L-A2	All	All 400
150.YB14L-A2	All	All 450
150.YB14-A2	04	650 4x4 Automatic
150.YTX24HL-BS	All	700 Diesel

Bombardier

ATV City Part No.	Year	Model
150.YTX4L-BS	02-03	DS 50, Quest 50
150.YTX4L-BS	02-03	DS 90, DS 90F, Quest 90
150.YB14A-A2	03	Rally 200
150.YTX15L-BS	04	Outlander 330
150.YTX15L-BS	03	Outlander 400
150.YTX15L-BS	04	Outlander 400 XT, Max
150.Y50-N18L	02-03	Traxter 500 All, Quest 500
150.YB16CL-B	99-03	Traxter 500 All, Quest 500
150.YTX15L-BS	00-03	DS 650
150.YB16CL-B	02-03	Quest 650

Cannondale

ATV City Part No.	Year	Model
150.YTX9-BS	02-03	Biazee 440, Cannibal
150.YTX9-BS	01	Glamis, Moto 440, Speed FX 400

E-Ton

ATV City Part No.	Year	Model
150.YTX4L-BS	99-03	AXL50, TXL50, NXL50, RXL 50
150.YTX5L-BS	04-05	50 All models
150.YTX5L-BS	00-03	AXL90, TXL 90, NXL90, RXL90
150.YTX4L-BS	99-03	DXL 90 Sierra
150.YTX5L-BS	04-05	90 All models
150.YTX9-BS	00-01	CXL150 Yukon II
150.YTX9-BS	02-03	YXL 150 Yukon

Honda

ATV City Part No.	Year	Model
150.YTX12-BS	86-87	ATC 125M
150.YB9A-A	84-85	ATC 125M
150.YTX9-BS	87-88	TRX 125 Fourtrax
150.YB9A-A	85-86	TRX 125 Fourtrax
150.YB14A-A2	82-84	ATC 200 Big Red
150.YB14A-A2	84-85	ATC 200M
150.YTX12-BS	90-96	TRX 200 Fourtrax
150.YB14A-A2	84	TRX 200 Fourtrax
150.YTX12-BS	86-88	TRX 200SX Fourtrax
150.YTX12-BS	85-87	ATC 250ES Big Red
150.YTX12-BS	85-87	ATC 250SX
150.YTX12-BS	85-87	TRX 250 Fourtrax
150.YTX12-BS	97-05	TRX 250 Fourtrax Recon, ES
150.YTX12-BS	97-03	TRX 250 Recon, ES
150.YTX9-BS	01-03	TRX 250EX, Sportrax 250
150.YTX14-BS	92-00	TRX 300 Fourtrax
150.YTX9-BS	93-03	TRX 300EX, Sportrax
150.YTX14-BS	88-00	TRX 300FW Fourtrax 300 4x4
150.YTX12-BS	85	FL 350R Odyssey
150.YTX14-BS	86-89	TRX 350, D Fourtrax 4x4
150.YTX14-BS	00-05	TRX 350 Rancher
150.YTX14-BS	89-90	FL 400R Pilot
150.YTX14-BS	95-03	TRX 400FW Foreman
150.YTX14-BS	04-05	TRX 400 Rancher AT
150.YTX9-BS	99-05	TRX 400EX, Fourtrax 400, Sportrax 400
150.YTX14-BS	98-04	TRX 450 Fourtrax Foreman S, ES
150.YTX14-BS	01-05	TRX 500 Fourtrax Rubicon
150.YTX14-BS	03-05	TRX 650 Fourtrax Rincon (Std)

BATTERY FITMENT CHART



Kawasaki

ATV City Part No.	Year	Model
150.YTX5L-BS	03-05	KSF 80-A (KFX 80)
150.YB10A-A2	88-02	KLF 220-A Bayou
150.YB14A-A2	92-02	KLF 220-A Bayou (CN)
150.YB10A-A2	03-05	KLF 250-A Bayou
150.YB14A-A2	03-05	KLF 250-A Bayou (CN)
150.YB14A-A2	95-00	KEF 300-A Lakota
150.YB14A-A2	01-03	KEF 300-A Lakota Sport
150.YB16CL-B	86-87	KLF 300-A Bayou
150.YB14A-A2	88-04	KLF 300-B Bayou
150.YB16CL-B	92-99	KLF 300-B Bayou (CN)
150.YB14A-A2	89-04	KLF 300-C Bayou 300 4x4
150.YB16CL-B	92-05	KLF 300-C Bayou 300 4x4 (CN)
150.YB14A-A2	99-02	KVF 300-A Prairie 300 4x4
150.YB16CL-B	99-01	KVF 300-A Prairie 300 4x4 (CN)
150.YB14A-A2	99-02	KVF 300-B Prairie 4x4
150.YB16CL-B	99-02	KVF 300-B Prairie 4x4 (CN)
150.YB14A-A2	03-05	KVF 360-A, B, C Prairie 360 4x4
150.YB16CL-B	93-00	KLF 400-B Bayou 400 4x4
150.YTX9-BS	03-05	KSF 400-A (KFX 400)
150.YB14A-A2	97-00	KVF 400-A Prairie 400 4x4
150.YB16CL-B	97-00	KVF 400-A Prairie 400 4x4 (CN)
150.YB14A-A2	98-00	KVF 400-B Prairie 400 4x4
150.YB16CL-B	98-00	KVF 400-B Prairie 400 4x4 (CN)
150.YB14A-A2	99-02	KVF 400-C Prairie 400 4x4
150.YTX14-BS	99-02	KVF 400-C Prairie 400 4x4 (CN)
150.YB14A-A2	99-02	KVF 400-D Prairie 400 4x4
150.YTX14-BS	99-01	KVF 400-D Prairie 400 4x4 (CN)
150.KMX14-BS	02-05	KVF 650-A, B, D, E Prairie 650 4x4
150.KMX14-BS	03-04	KFX 700 V-Force
150.KMX14-BS	04-05	KSV 700-A, B Prairie 700 4x4
150.KMX14-BS	04-05	KSV 700-A, B D Prairie 700 4x4
150.KMX14-BS	04	KVF 650-A, B Prairie 700 4x4
150.KMX14-BS	05	KVF 750-A, B, Brute Force 750 4x4

Polaris

ATV City Part No.	Year	Model
150.YTX5L-BS	04-05	50 Predator
150.YTX4L-BS	01-02	50 Scrambler
150.YTX5L-BS	03	50 Scrambler
150.YTX5L-BS	03-05	90 Predator, Sportsman
150.YTX4L-BS	01-02	90 Scrambler, Sportsman
150.YTX12-BS	05	200 Phoenix
150.YB14A-A2	85-05	250 All
150.YB14A-A2	87-02	325 All
150.YTX14AH-BS	03-05	330 Magnum, Trail Boss
150.YB14A-A2	98-01	335 Sportsman
150.YB14A-A2	94-05	400 All
150.YB14A-A2	95-02	425 All
150.YB30L-B	99-03	450 Diesel 445 litre (primary)
150.YB14A-A2	99-03	450 Diesel 445 litre (secondary)
150.YB14A-A2	99-05	500 All (utom Predator)
150.YTX9-BS	03-05	500 Predator
150.YB30L-B	04-05	600 Sportsman
150.YB30L-B	02-05	700 Sportsman Military
150.YB30L-B	05	800 Sportsman

BATTERY FITMENT CHART

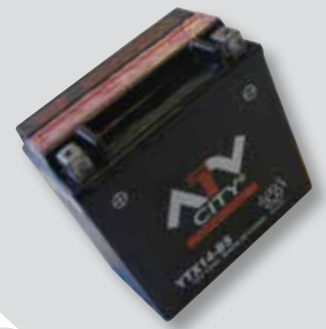

Suzuki

ATV City Part No.	Year	Model
150.YTX5L-BS	88-93	LT 80 Quad Sport
150.YB9A-A	86-87	LT-F 160 QuadRunner
150.YB9A-A	85-86	LT 160E QuadRunner
150.YB9A-A	87-99	LT 160E QuadRunner
150.YTX12-BS	87-99	LT 230E QuadRunner
150.YB10A-A2	88-01	LT-F230 QuadRunner
150.YB10A-A2	88-01	LT 230GE Quadrunner
150.YB14A-A2	02-05	LT 250 4WD QuadRunner
150.Y50-N18A-A	03-05	LT 250 4WD QuadRunner (Opt)
150.YB14A-A2	98-01	LT-F 250 QuadRunner
150.Y50-N18A-A	94-05	LT-F 250 QuadRunner (Opt)
150.YTX12-BS	95-02	LT-F 250, F Ozark
150.YB14A-A2	99-02	LT-F 250F QuadRunner
150.Y50-N18A-A	99-02	LT-F 250F QuadRunner (CN. Opt)
150.Y50-N18A-A	85-86	LT 250EF QuadRunner
150.YTX12-BS	04-05	LT-Z 250 Quadrunner
150.Y50-N18A-A	91-99	LT-F 4WDX Kingquad (CN, Opt)
150.YB14A-A2	87-89	LT 300E Quadrunner 300E
150.YB14A-A2	99-02	LT-F 4WDX King Quad
150.Y50-N18A-A	99-02	LT-F 4WDX King Quad
150.YTX14-BS	02-05	LT-A 400 Eiger 2WD, F Eiger 4WD
150.YTX14-BS	02-05	LT-F 400 Eiger 2WD, F Eiger 4WD
150.YTX9-BS	03-05	LT-Z 400 Quadsport
150.YTX20CH-BS	04-05	LT-A 500F Vinson 4WD
150.YTX16-BS	02-03	LT-A 500F Vinson 4WD
150.YTX16-BS-1	00-01	LT-A 500F QuadMaster
150.YTX16-BS-1	98-03	LT-F 500F QuadRunner
150.YTX20CH-BS	04-05	LT-F 500F Vinson Manual 4WD
150.YTX20CH-BS	05	LT-A 700X King Quad
150.KMX14-BS	04	LT-V 700F Twin Peaks
150.YTX20CH-BS	04	LT 700 Twin Peaks

Yamaha

ATV City Part No.	Year	Model
150.12N7D-3B	85-01	YFM 80 Badger
150.12N7D-3B	02-03	YFM 80R Raptor
150.12N7D-3B	87-91	YFM 100 Champ
150.YB12C-A	89-03	YFA-1 Breeze
150.YB14A-A1	85	YFM 200 Moto-4
150.YB14A-A1	85-89	YFM 200DX Moto-4
150.YB14A-A1	83-85	YTM 200, E, ER Tri Moto
150.YB14A-A1	86-88	YFM 225 Moto-4
150.YB14A-A1	85-86	YTM 225DR Tri-Moto
150.YB14A-A1	83-85	YTM 225DX Tri-Moto
150.YB14A-A1	89	YFU-1/T Pro Hauler 230
150.YB12C-A	92-98	YFB 250 Timber Wolf 2WD
150.YB12C-A	94-00	YFB 250FW Timber Wolf 4WD
150.YB14A-A2	99-04	YFM 250 Bear Tracker
150.YB14A-A1	89-91	YFM 250 Moto-4
150.Y814A-A1	87-95	YFM 350ER Moto-4
150.YB14A-A1	87-99	YFM 350FW Big Bear 4WD
150.YB14A-A1	96-99	YFM 350U Big Bear 2WD
150.YB12C-A	87-03	YFM 350 Warrior
150.YB14A-A1	88	YFP 350 Terra Pro
150.YTZ10S	04-05	Raptor 350
150.YTX14AH-BS	03	YFM 400FW Kodiak/Automat
150.YTX20L-BS	96-02	YFM 400FW Kodiak/Automat
150.YB14A-A1	93-95	YFM 400FW Kodiak
150.YTX20L-BS	00-03	YFM 400N Big Bear 2WD
150.YTX20L-BS	00-03	YFM 400FWN Big Bear 4WD
150.YT7B-BS	04	YFZ 450
150.YTX20L-BS	03	YFM 450FW Kodiak/ Automat
150.YTX20L-BS	98-01	YFV 600FW Grizzly
150.YTX20L-BS	02-03	YFM 660FW Grizzly
150.YTX14-BS	01-03	YFM 660R Raptor

Bearings

Braking

Bullbars

Cables

Carburettor

Driveline

Electrical

Exhausts

CDI UNITS



Honda

ATV City Part No.	Model	OEM REF Number
155.01539	"TRX 250 97-01 TRX 250 RECON 98-01"	30410-HM8-003
155.0110	TRX 300 88-92	30410-HC4-770
155.0105	TRX 300 93-97	30410-HM5-672
155.0112	TRX 350 FM/FE 00-05	30410-HN5-671
155.0120	TRX 350 FM/FE 2006	30410-HN5-N01
155.0115	TRX 400FW 95-03	30410-HM7-003

Kawasaki

ATV City Part No.	Model	OEM REF Number
155.0050	KLF300B/C	21119-1369 / 1302 / 1258

Suzuki









ATV City Part No.	Model	OEM REF Number
155.01572	LT160 F	32900-02C00

Yamaha

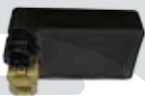
ATV City Part No.	Model	OEM REF Number
155.01572	YFM 350 Big Bear YFM 350 Moto-4 1995	3HN-85540-20-00 3HN-85540-30-00
155.01593	YFM 350 Bruin 04-06 YFM 350 Grizzly 07-14 YFM 350 Wolverine 06-09	5UH-85540-00-00
155.01592	YFM 350 Grizzly (IRS) 07	4S2-85540-00 4S2-85540-01-00
155.01599	YFM 400 Grizzly 07-08 YFM 400 Kodiak 05-08	1P1-85540-10-00
155.01600	YFM 450 Grizzly 07 YFM 450 Kodiak 04-06	5ND-85540-10
155.01591	YFM 660 Grizzly 02-03	5KM-85540-00

CDI UNITS



	ATV City Part No.
	155.0050
	155.0110
	155.0115
	155.0120
	155.0200
	155.01539
	155.01572
	155.01591
	155.01592
	155.01593

	ATV City Part No.
	155.01599
	155.01600
	155.01601
	157.0105
	157.0110
	157.02097
	157.02098
	157.02099
	157.02300
	157.02357

REGULATORS/RECTIFIERS



Honda

ATV City Part No.	Model	OEM REF Number
157.0055	TRX 250 97-05 TRX 250 EX 97-05 TRX 400 EX 99-04	31600-HM8-003/013
157.02342	TRX 300 88-92	31600-HC4-010 SH532B-12
157.0057	TRX 300 FW 93-00	SH532C-13 31600-HC5-970
157.0060	TRX 350 00-06 TRX 400 96-01 TRX 450 98-01	31600-HN5-671
157.0070	TRX400FA Rancher (Auto)	31600-HN7-003
157.0122	TRX 420 Rectifier 07-13 (Small with wires)	31710-HP5-651
157.0120	TRX 420 FM/TM/FE/TE; 07-14	31600-HP5-601
157.0065	TRX 450 02-04	31600-HN0-671
157.0125	TRX 500 FM/FE/FA 05-11 TRX 680 FA 06-14	31600-HP0-A01
157.0130	TRX 500 FA/FM/FE 12-14	31600-HR0-F01

Kawasaki

ATV City Part No.	Model	OEM REF Number
157.02082	KLF 220 88-95	21066-1052 SH561-12
157.02065	KLF 220 88-95	21066-1038 SH548-12
157.0020	KLF 300B/C 89-02	21066-1089 (NO WIRES) SH650A-12
157.02398	KLF300 03-05 KVF300/400/360/650/700	21066-1112 21066-0047

REGULATORS/RECTIFIERS



Polaris

ATV City Part No.	Model	OEM REF Number
157.02097	Trail Blazer 250 98 Trail Boss 98 Xplorer 300 98-99 Scrambler 400 98-99 Sport L 400 98	4060193 (LR39-1)
157.02098	Big Boss Swedish 6x6 500 98 Big Boss 6x6 500 98-99 Big Boss Norwegian 6x6 500 98 Magnum 500 99-02 Magnum 2x4 HDS 500 02 Magnum EB 500 00 Magnum RMK 500 02 Magnum 4x4 HDS 500 00 Magnum 500 HDS 500 01 Magnum VL HDS 500 02 Magnum 4x4 HDS 500 00 Ranger Series 10 Ranger Series 10 500 Ranger 99 Scrambler 500 97-00 Scrambler 2x4 500 01-02 Scrambler 4x4 500 01-02 Scrambler 4x4 Freedom 500 02 Sportsman HO 500 01 Sportsman RSE 500 99-00 Sportsman 6x6 00-02 Sportsman 500 98-00 Sportsman Swedish 500 98 UTV Series 10 2x4 UTV Series 10 4x4 Worker 500 99-01	4060173 (LR39)
157.02099	Magnum 425 98 Magnum 325 4x2 00-02 Magnum 325 4x4 00-02 Sportsman 400 01-02 Sportsman 335 99-00 Xpedition 325 00-02 Xpedition 425 00-02 Xplorer 400 98-99	4060191 (LR-35)
157.02300	Xplorer 400 96-97 Magnum 425 96-97 Sportsman 500 96-97	4060133 (LR-37)
157.02357	Sportsman 600/700 04-07 Ranger 2x4, 4x4, 6x6 500 04	4010929

Bearings

Braking

Bullbars

Cables

Carburettor

Driveline

Electrical

Exhausts



REGULATORS/RECTIFIERS



Suzuki

ATV City Part No.	Model	OEM REF Number
157.02386	LTF/LTZ250 04-07	32800-05F10
157.02400	LTF300 King Quad 99-01	32800-19B11
157.02405	LTF / LTA400 2008-12	32800-14G00 / 32800-20H00

Yamaha

ATV City Part No.	Model	OEM REF Number
157.02401	YFA Breeze YFM 50 YFM 80	5TH-81960-01
157.0110	YFM 125 Grizzly 04-08 YFM 250 BearTracker 01-04 YFM 250 Big Bear YFM 350 Bruin 05-06 YFM Raptor 08 YFM 350 Bruin 04-06 YFM 350 Raptor 04-08 YFM 350 / 450 Wolverine 06-08 YFM 350 Grizzly 07-08 YFM 400 Big Bear YFM 400 Kodiak 00-06 YFM 400/450 Grizzly Hunter 07-08 YFM 450 Kodiak 03-06 YFM 600 Grizzly 99-01 YFM 660 Raptor 01-05	5GT-81960-00-00
157.0100	YFM 250/350/400/660 5-Wire	4KB-81960-01 59V-81960-01
157.0103	YFM 250/350/400/600	4KB-81960-10-00 SH640-11
157.0105	YFM 400FW 93-95	4GB-89160-00-00
157.0115	YXR 450 Rhino 06-08 YFM 660 Grizzly 02-08 YXR 660 Rhino 04-07 YFM 700 Raptor 06-08	5BN-81960-00-00
157.0125	YFM 550 Grizzly 07-12 YFM 700 Grizzly 07-12 YXR 700 Rhino F1 08-09	1D7-81960-00-00 1D7-81960-10-00

REGULATORS



	ATV City Part No.
	155.0105
	155.0112
	157.0020
	157.0055
	157.0057
	157.0060
	157.0065
	157.0100
	157.0103
	157.0115
	157.0120

	ATV City Part No.
	157.0122
	157.0125
	157.0130
	157.02065
	157.02082
	157.02342
	157.02386
	157.02398
	157.02400
	157.02401
	157.02405

Bearings

Braking

Bullbars

Cables

Carburettor

Driveline

Electrical

Exhausts

STATOR UNITS

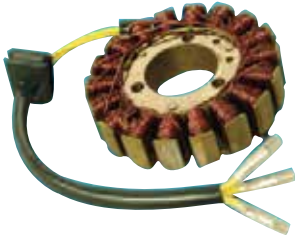
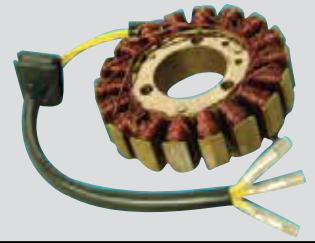



Yamaha

ATV City Part No.	Model	OEM REF Number
292.0005	YFM 350 FWBJ-FWBK Big Bear 97-98	4KB-85510-11-00
	YFM 350 Wolverine 00-01	4KB-85510-12-00
	YFM 400 FWBL Kodiak 99	5EH-85510-00-00
292.02913	YFM 350 FWT Big Bear 1987	1UY-85510-20-00
	YFM 350 FWA-FWF 90-94	2XK-85510-20-00
	YFM 350 ERA Moto-4 90-94	3HN-85510-00-00
	YFM 350 XT Warrior 1987	
292.02914	YFM 350 FWG Big Bear 95	3HN-85510-10-00
	YFM 350 ER G 95	4GB-85510-00-00
	YFM 350 X Warrior 96-01	
	YFM 400 FW Kodiak 93-98	
292.02915	YFM 350 Bruin 04-06	5KM-81410-00-00
	YFM 350 Wolverine 06-09	5LP-81410-01-00
	YFM 350 Grizzly 07-14	5UH-81410-00-00
	YFM 600 Grizzly 2002	5UH-81410-00-01
	YFM 660 Raptor 02-05	5UH-81410-00-02
	YFM 660 FP/FA Grizzly 02-06	5KM-81410-01-00
292.02917	YFM 350 Raptor 04-07	5NF-81450-00-00
	YFM 350 Raptor 07-11	5NF-81450-01-00
	YFM 350 Warrior 02-04	5FU-81410-00-00
	YFM 400 M/H/F/FW Big Bear 00-12 (Manual)	

BULBS





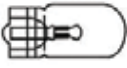

Bulbs

	Type	ATV City Part No.
	12V 35/35 1-Pin Halogen (Headlight) (sold individually)	175.0020
	12V 25/25 1-Pin (Headlight) (sold in packs of 10)	175.0015
	12V 21/5 2-Pin Offset (Tail Light) (sold in packs of 10)	175.0010
	12V 5W Capless (Instrument) (sold in packs of 10)	175.0005

FUSES

Fuses

	Type	ATV City Part No.
	3 AMP Mini Blade (Pack of 10)	177.0003
	7.5 AMP Mini Blade (Pack of 10)	177.0007
	10 AMP Mini Blade (Pack of 10)	177.0010
	15 AMP Mini Blade (Pack of 10)	177.0015
	20 AMP Mini Blade (Pack of 10)	177.0020
	30 AMP Mini Blade (Pack of 10)	177.0030

Bearings

Braking

Bullbars

Cables

Carburettor

Driveline

Electrical

Exhausts



HANDLEBAR PARTS



Heated handle bar grips & Seat Heater

ATV City Part No.	Description
392.0010	Complete with thumb warmer and two heat settings.
392.210015	Heat Demon ATV Heated Grips - Glue on Type
392.210024	Heat Demon ATV Heated Grips - Poco
392.210008	Heat Demon ATV Heated Grips - Thumb Warmer
392.210044	Heat Demon ATV Seat Heater



Handle Bar Grips

ATV City Part No.	Description
392.0020	The quick, hassle free way of securing your handle bar grips.



Grip Lock (Glue)

ATV City Part No.	Description
392.0050	ATV Grips FA Style



Handle bar switch block

ATV City Part No.	Description
120.0080	6-wire kill switch: lights on/off & start button.



Dead man's killswitch

ATV City Part No.	Description
120.0075	Tether type killswitch



Killswitches

ATV City Part No.	Description
120.0077	Killswitch, Honda CR Type (Can be wired in instead of ignition switch)
120.0073	Killswitch, Yamaha YZ Type (Can be used as a horn button)



Bearings

Braking

Bullbars

Cables

Carburettor

Driveline

Electrical

Exhausts

SPARK PLUGS & CAPS



Spark plugs

Spark plugs

Spark plugs

Order 50 or more assorted plugs and receive a 32% discount!

ATV City Part No.
160.B2LM
160.B6HS
160.B6S
160.B7HS
160.BCPR5ES
160.BKR5E11
160.BKR6E
160.BKR7E
160.BM6A
160.BMR2A
160.BMR4A
160.BMR6A
160.BMR7A
160.BP5ES
160.BP5HS
160.BP6ES
160.BP6HS
160.BP7HS
160.BP8ES
160.BPM6A
160.BPM7A
160.BPMR6A
160.BPMR7A

ATV City Part No.
160.BPR2ES
160.BPR4FS-11
160.BPR4HS
160.BPR5ES
160.BPR5HS
160.BPR6ES
160.BPR6HS
160.BPR7HS
160.BR2LM
160.BR6HS
160.BR8ES
160.BR8HSA
160.BR9ECS
160.BR9ES
160.C6HSA
160.C7HSA
160.CMR5H
160.CMR7A
160.CPR7EA9
160.CPR8EB-9
160.CR4HSB
160.CR6E
160.CR6HSA
160.CR7E
160.CR7HS

ATV City Part No.
160.CR7HSA
160.CR8E
160.CR8EB
160.CR8HS
160.CR9E
160.D6EA
160.D7EA
160.D8EA
160.DCPR8E
160.DPR7EA9
160.DPR8EA9
160.DR7EA
160.DR7ES
160.DR8EA
160.DR8ES
160.DR8ESL
160.IFR5L11
160.IFR8H11
160.IJR7A9
160.LMAR6A-9



Glow plugs

ATV City Part No.

160.Y760R
160.YE01

ATV City Part No.

162.VB05F
162.VD05F
162.XB05F
162.XD05F

LB05F / LD05F



VB05F / VD05F



SB05F / SD05F



XB05F / XD05F



Plug caps

ATV City Part No.

162.LB05F
162.LD05F
162.SB05F
162.SD05F
162.VD05EM



FULL RANGE OF NGK PLUGS AVAILABLE
IF NOT LISTED ABOVE



SPARK PLUGS & CAPS



Apache

Eng. Size	Model	Date	Standard Plug	Gap mm.
50	RLX 50		BR8HSA	0.7
50	Tomahawk Mini 50 (4-Stroke)	-->07	CR7HSA	0.6
50	Tomahawk Mini 50 (2-Stroke)	08-->	BR8HSA	0.7
100	Army 100		BR8HSA	0.6
100	RLX 100		BR8HSA	0.6
100	SX 100		BR8HSA	0.6
100	ZX100		BR8HSA	0.7
150	RLX 150 H		CR7HSA	0.6
150	RLX 150		CR7HSA	0.6
150	Superbug 150		CR7HSA	0.6
170	RLX 170 S		DR8EA	0.6
250	RLX 250 AX		DR8EA	0.6
250	RLX 250 S		CR8HS	0.7
250	RLX 250 SX		CR8HS	0.7
280	RLX 320		DPR7EA-9	0.9
360	RLX 400	10-->	CR8E	0.7
450	RLX 450		CR8E	0.7
500	RLX F500	10-->	DPR7EA-9	0.9

Bombardier

Eng. Size	Model	Date	Standard Plug	Gap mm.
50	DS 50 (Rotax)	02-->03	BPR7HS	0.6
50	DS 50	04-->05	BR9ECS	0.7
90	DS 90 (Rotax 2-Stroke)	02-->03	BPR7HS	0.6
90	DS 90 (Rotax 2-Stroke)	04-->05	BR9ECS	0.7
90	DS 90 (Rotax 4-Stroke)	02-->	CR7HSA	0.6
200	Rally (Rotax)	03-->05	CR8E	0.7
330	Outlander 330 HO (Rotax 4-TEC)	04-->05	BR9ECS	0.7
400	Outlander 400 HO (Rotax 4-TEC) Ø12mm Plug	03-->	DCPR8E	0.6
400	Outlander 400 Ø14mm Plug	04-->	BR9ECS	0.7
500	Traxter (Rotax) Ø12mm Plug	98-->02	DR8EA	0.7
500	Traxter (Rotax) Ø14mm Plug	03-->	BR9ECS	0.7
500	Traxter CVT	2005	DCPR8E	0.7
650	DS 650 (Rotax) Ø12mm Plug	00-->05	DR8EA	0.7
650	Quest 650 (Rotax 4-TEC) Ø12mm Plug	02-->03	DR8EA	0.7
650	Quest 650 Ø14mm Plug	03-->	BR9ECS	0.7

Arctic Cat

Eng. Size	Model	Date	Standard Plug	Gap mm.
50	50	06-->	CR7HSA	0.6
90	90	06-->	CR7HSA	0.6
150	150	09-->	DR8EA	0.7
250	250	01-->	DR7EA	0.6
300	300	05-->	DR7EA	0.6
300	DVX 300	08-->	DPR7EA-9	0.9
366	400 H1	08-->	CR7E	0.7
400	400		CR7E	0.7
400	DVX 400	04-->08	CR7E	0.7
500	500		CR6E	0.8
550	550		CPR8E	0.8
650	650	04-->05	CR7E	0.7
650	650 H1	05-->	CPR8E	0.8
700	700 H1	09-->	CPR8E	0.8

Can-Am

Eng. Size	Model	Date	Standard Plug	Gap mm.
50	DS 50	06	BR9ECS	0.7
70	DS 7	08-->	CR7HSA	0.7
90	DS 90 (Rotax 2-Stroke)	2006	BR9ECS	0.7
90	DS 90 (Rotax 4-Stroke)	06-->	CR7HSA	0.6
200	Rally (Rotax)	06-->07	CR8E	0.7
250	DS 250	06-->	CR8E	0.7
400	Outlander 400 HO (Rotax 4-TEC) Ø12mm Plug	06-->	DCPR8E	0.6
400	Outlander 400 Ø14mm Plug	06-->	BR9ECS	0.7
400	Outlander MAX	13-->	DCPR8E	0.7
450	DS 450	08-->	DCPR9E	0.7
500	Outlander 500	07-->	DCPR8E	0.7
500	Renegade 500	08-->	DCPR8E	0.7
500	Traxter (Rotax) Ø14mm Plug	06-->	BR9ECS	0.7

SPARK PLUGS & CAPS



Can-Am (Continued)

Eng. Size	Model	Date	Standard Plug	Gap mm.
650	DS 650 (Rotax) Ø12mm Plug	06-->07	DR8EA	0.7
650	Outlander 650	06-->	DCPR8E	0.7
650	Quest 650 Ø14mm Plug	06-->	BR9ECS	0.7
800	Commander 800	11-->	DCPR8E	0.7
800	Outlander 800 (Incl. R, X & XC models)	06-->	DCPR8E	0.7
800	Renegade 800	07-->	DCPR8E	0.7
1000	Commander 1000	11-->	DCPR8E	0.7

Club Car

Eng. Size	Model	Date	Standard Plug	Gap mm.
719	Carryall 294, 295 (Kubota D722 engine)	04-->	YE01	-

E-Ton

Eng. Size	Model	Date	Standard Plug	Gap mm.
40	JXL40 Viper	03-->	BPM7A	0.6
40	RXL40E		BPM7A	0.6
50	RXL50 Viper	02-->	BPR7HS	0.7
70	RXL70		BPR7HS	0.7
90	DXL90 Sierra	03-->	BPR7HS	0.7
90	RXL90 R		BPR7HS	0.7
90	RXL90 Viper	02-->	BPR7HS	0.7
150	CXL150 Challenger	99-->	C7HSA	0.7
150	RXL150 Viper	09-->	C7HSA	0.7
150	YXL150 Yukon	99-->	C7HSA	0.7

Honda

Eng. Size	Model	Date	Standard Plug	Gap mm.
70	ATC70, ATC70-D	78-->85	CR7HS	0.7
90	TRX90 Sportrax	94-->	CR6HSA	0.6
110	ATC110	79-->85	DR8HS	0.7
125	ATC125M	84-->87	DR8ES-L	0.7
125	TRX125 All variants	85-->88	DR8ES-L	0.7
185	ATC185S-D	79-->82	DR8ES-L	0.7

Honda (Continued)

Eng. Size	Model	Date	Standard Plug	Gap mm.
200	ATC200 (EC/XD/ESE)	81-->84	DR8ES-L	0.7
200	TRX200 All variants	84-->97	DR8ES-L	0.7
250	ATC250R-D	81-->83	BR8ES	0.7
250	ATC250R-F/G	85-->86	BR9ES	0.7
250	TRX250 RH, RJ, RK	86-->89	BR9ES	0.7
250	TRX250 EX Sportrax	01-->08	DPR8EA-9	0.9
250	TRX250 TM/TE Fourtrax S/ES	02-->	DPR8EA-9	0.9
300	TRX300FW-V	94-->99	DPR8EA-9	0.9
300	TRX300EX	00-->01	DR8ES-L	0.7
350	TRX350-H, J, K, L, M, N, P	86-->93	DR8ES-L	0.7
350	TRX350 TM/TE Fourtrax S/ES	01-->06	DPR7EA-9	0.9
400	TRX400AT Fourtrax	05-->	DPR8EA-9	0.9
400	TRX400EX Sportrax	05-->	DPR8EA-9	0.9
420	TRX420 FE/FM/FPM/TE/TM Fourtrax ES	07-->	BKR5E-11	1.1
450	TRX450 FE/FM ES/S	97-->02	DPR7EA-9	0.9
450	TRX450R Sportrax	06-->	#	1.1
475	TRX500 ES/FM/FE Foreman Ø14mm Plug (Manual)	05-->	BKR5E-11	1.1
500	TRX500 FA1, FA2, FA3 Foreman AT Ø12mm Plug (Auto)	01-->	IJR7A-9	0.9
650	TRX650FA Rincon AT	04-->	IFR5L-11	1.1
675	TRX680FA Rincon	05-->	IFR5L-11	1.1

Kawasaki

Eng. Size	Model	Date	Standard Plug	Gap mm.
50	KFX50 A	03-->	BPR4HS	0.7
220	KLF220 A	88-->02	DR8ES	0.7
250	KLF250	03-->	DR8ES	0.6
300	KAF300 A-C (Mule 500/550)	91-->04	BPR5ES	0.8
300	KLF300 (Ø14mm Plug)	86-->88	BR8ES	0.6
300	KLF300 (Ø12mm Plug)	89-->	DR8EA	0.7
300	KVF300	99-->04	DR8EA	0.7
300	KVF300	12-->	DPR7EA-9	0.9
360	KVF360	02-->	DPR8EA-9	0.9

SPARK PLUGS & CAPS



Kawasaki (Continued)

Eng. Size	Model	Date	Standard Plug	Gap mm.
400	KAF400 A, B (Mule 600/610)	05-->	BPR6ES	0.6
400	KFX400	03-->	CR7E	0.7
400	KLF400 B	93-->99	DPR8EA-9	0.9
400	KVF400	99-->	DPR8EA-9	0.9
450	KAF450 (Mule 1000)	88-->	D6EA	0.7
450	KFX450R	08-->	CPR8EB-9	0.9
540	KAF540 C (Mule 2010)	02-->05	BP5ES	0.5
620	KAF620 D (Mule 2500E)	1990	BMR4A	0.7
620	KAF620 A-D (Mule 2510/2500)	93-->00	BMR2A	0.7
620	KAF620 E, G (Mule 3010/3000)	01-->	BPR2ES	0.7
650	KVF650	02-->	CR7E	0.7
700	KFX700 V Force	04-->	CR7E	0.7
700	KVF700 A	04-->	CR7E	0.7
750	KVF750 A-D	05-->	CR7E	0.7
950	KAF950 A-D Diesel (Mule 2510, 3010)	98-->08	Y-706R	-

Kymco (Continued)

Eng. Size	Model	Date	Standard Plug	Gap mm.
443	MXU 450i	12-->	CR7E	0.6
500	MXU 500	-->11	CR7E	0.6
500	MXU 500i IRS	12-->	CR7E	0.6
500	UXV 500		CR7E	0.9

Massey Ferguson

Eng. Size	Model	Date	Standard Plug	Gap mm.
250	MF250 2WD	06-->08	DR7EA	0.6
350	MF350MRP 4WD Manual 5 Speed	06-->08	DR7EA	0.6
400	MF400MRP 4WD Manual 5 Speed	06-->08	CR6E	0.8
450	MF450MRP 4WD Automatic	06-->08	CR6E	0.8
500	MF500MRP 4WD Automatic & Manual 5 Speed	06-->08	CR6E	0.8
500	MF500TBX 4WD Automatic	06-->08	CR6E	0.8

Kubota

Eng. Size	Model	Date	Standard Plug	Gap mm.
898	RTV900	04-->	YE01	-
1123	RTV1100	07-->	YE01	-

Kymco

Eng. Size	Model	Date	Standard Plug	Gap mm.
50	KXR 50		BR8HSA	0.6
90	KXR 90		C7HSA	0.7
150	MXer 150 /RL	01-->	DR8EA	0.7
150	MXU 150 RL	05-->	DR8EA	0.7
250	KXR 250 /RL	01-->	DPR7EA-9	0.9
250	MXU 250 RL, Maxxer 250		DPR7EA-9	0.9
300	MXU 300 RL, Maxxer 300	05-->	DPR7EA-9	0.9
400	MXU 400		CR8E	0.7

Polaris

Eng. Size	Model	Date	Standard Plug	Gap mm.
50	Predator 50	03-->	BPR7HS	0.6
90	Predator 90	03-->	BPR7HS	0.6
90	Sportsman 90		BPR7HS	0.6
200	Phoenix 200	05-->	CR6HSA	0.7
200	Sawtooth	06-->	CR7HSA	0.7
250	Trail Blazer 250		BR8ES	0.7
300	Hawkeye 300 2x4, 4x4	06-->	CR8EB	0.8
330	Magnum 330		BKR6E	0.9
330	Trail Boss 330		BKR6E	0.9
400	Sportsman 400 H.O.	09-->	BKR6E	0.9
450	Sportsman 450		BKR6E	0.9
500	Predator 500	05-->	DCPR8E*	0.9
500	Predator Troy Lee	06-->	DCPR8E*	0.9

SPARK PLUGS & CAPS



Polaris

Eng. Size	Model	Date	Standard Plug	Gap mm.
500	Ranger 4x4 EFI		BKR6E	0.9
500	Scrambler 500		BKR6E	0.9
500	Sportsman 500 EFI		BKR6E	0.9
500	Sportsman 500 H.O. EFI (Incl. Touring)	09-->	BKR6E	0.9
650	Ranger TM	06-->	BPR5ES	0.9
680	Ranger 6x6 EFI		BKR7E	0.9
680	Ranger XP		BKR7E	0.9
700	Sportsman 700 EFI		BKR7E	0.9
700	Sportsman 700 Twin		BKR7E	0.9
800	Sportsman 800 EFI		BKR7E	0.9
850	Sportsman XP 850	-->09	LKAR8A-9	0.9

Quadzilla

Eng. Size	Model	Date	Standard Plug	Gap mm.
50	Buzz	03-->07	BPR7HS	0.6
100	M100		BP7HS	0.7
100	ProShark	04-->	BP8ES	0.6
100	ProShark E		BR8HSA	0.6
100	ProShark Type R		BP8ES	0.6
100	R100		BPR7HS	0.6
100	X100 Single piece head (12.7mm Thread Reach)		BR8HSA	0.6
100	X100 Twin piece head (19mm Thread Reach)		BP8ES	0.6
165	R170E Stinger	03-->06	DR8EA	0.7
200	200E 4 Cross		DR8EA	0.7
200	ST200E	06-->07	CR7HSA	0.6
250	PGO 250E Bugrider		DPR7EA-9	0.9
250	R250E Stinger		CR8HS	0.7
250	R250E Triple Disc		CR8HS	0.7
250	XRV 250	06-->07	DPR7EA-9	0.9
300	300E SUV 4 Valve		DR8EA	0.7
500	XLC500	08-->	DCPR8E*	0.9
700	RS7	10-->	CR6E	0.8
750	RS8	11-->	CR6E	0.8

Suzuki

Eng. Size	Model	Date	Standard Plug	Gap mm.
50	LT50 -->K4/K5 (Ø14mm Plug)	-->05	BPR4HS	0.7
50	LT-A50 -->K4/K5 (Ø14mm Plug)	-->05	BPR4HS	0.7
50	LT-Z50 K5/K6 (Ø10mm Plug)	05-->	CR6HSA	0.7
80	LT80 P-R-S		BP7HS	0.7
80	LT80 T-V-W-X-Y K1-K5		BPR7HS	0.7
90	LT-Z90	06-->	CR6HSA	0.7
250	LT-4WD	87-->98	DR7ES	0.7
250	LT-F250F Ozark	99-->02	DR7EA	0.6
250	LT-F250	03-->	DR7EA	0.6
250	LT-Z250 K4-K5	04-->	DR7EA	0.6
300	LT-F300F	99-->02	DR7EA	0.7
400	LT-A400F K2 (Eiger)	02-->	CR7E	0.7
400	LT-F400 Eiger 2WD		CR7E	0.7
400	LT-F400F Eiger 4WD	02-->09	CR7E	0.7
400	LT-F400FSi KingQuad	10-->	CR7E	0.7
400	LT-Z400	03-->	CR7E	0.7
450	LT-A450X	07-->	CR6E	0.8
450	LT-R450	06-->	CR8EB	0.7
500	LT-A500XP KingQuad	10-->	CR6E	0.8
500	LT-F500F	98-->07	CR7E	0.7
700	LT700A K5	05-->	CR6E	0.8
700	LT-A700X K7	07-->	CR6E	0.8
722	LT-A750X	08-->	CR6E	0.8

TGB

Eng. Size	Model	Date	Standard Plug	Gap mm.
90	Hornet 90		BPR7HS	0.6
250	Blade 250		CR8E	0.8
287	Blade 325 SL 2WD		CR8E	0.8
287	Target 325 SL 2WD		CR8E	0.8
403	Blade 425 SL 4WD	10-->	CR7E	0.7
403	Blade 450 SE IRS 4WD	10-->	CR7E	0.7
460	Blade 460 R 2WD	12-->	CR7E	0.7
503	Blade 550 LT 4WD	11-->	CR7E	0.7
503	Blade 550 SE IRS 4WD	11-->	CR7E	0.7
503	Target 550 IRS 4WD	11-->	CR7E	0.7

SPARK PLUGS & CAPS



Yamaha

Eng. Size	Model	Date	Standard Plug	Gap mm.
50	YFM50 Mini Raptor	03-->05	CR7HS	0.6
50	YFM50 Mini Raptor	06-->	CR7HSA	0.7
60	YT60L (Tri-Moto)		BP6HS	0.6
80	YFM80	92-->03	CR7HS	0.7
80	YFM80 Badger	04-->	CR7HSA	0.7
80	YFM80 Raptor	06-->	CR7HSA	0.7
125	YFA1 Breeze	90-->03	CR7HS	0.7
125	YFA1 Breeze	04-->	CR7HSA	0.7
125	YFM125S Grizzly	04-->	CR7HSA	0.7
200	YTM200EL Yamahauler	1984	D7EA	0.7
200	YFM200N (Moto-4)	85-->90	D7EA	0.6
200	YFS200 Blaster	88-->	BR8ES	0.6
200	YTM200EK (Tri-Moto)		D7EA	0.6
215	G1A Utility/Golf Kart	79-->	BP5HS	0.7
225	YFM225		DR7ES	0.6
230	YFU1 Pro Hauler	89-->90	DR7EA	0.7
250	YFB250 Timberwolf 2WD/4WD	92-->97	DR7EA	0.6
250	YFM250	88-->90	DR7EA	0.7
250	YFM250X Bear Tracker	99-->04	DR7EA	0.7
250	YFM250 Bear Tracker	05-->	DR7EA	0.6
250	YFM250B Bruin/Big Bear	05-->	DR7EA	0.6
250	YFM250R Raptor	08-->	DR7EA	0.6
285	G2A, G5A, G8A, G9A Utility/Golf Kart	85-->	BR4ES	0.8
285	G3A Utility/Golf Kart	86-->	BP5HS	0.7
287	YFM30GB Grizzly	12-->	CR8E	0.8
350	G23A Utility/Golf Kart	03-->06	BPR2ES	0.7
350	YFM350 Big Bear 2WD		DR8ES-L	0.6
350	YFM350 Big Bear 4WD	87-->93	DR8ES-L	0.6
350	YFM350 Big Bear 4WD	94-->97	DR8EA	0.8
350	YFM350A, FWA Bruin 2WD/4WD	03-->	DR8EA	0.8
350	YFM350ER	93-->95	DR8ES	0.7
350	YFM350FWB	97-->01	DR8EA	0.7
350	YFM350FX Wolverine	95-->99	DR8EA	0.7

Yamaha (Continued)

Eng. Size	Model	Date	Standard Plug	Gap mm.
350	YFM350R Raptor	05-->	DR8EA	0.8
350	YFM350U	96-->01	DR8EA	0.7
350	YFM350X Warrior	87-->04	DR8EA	0.8
350	YFZ350 Banshee	87-->	BR8ES	0.6
360	G27A U-Max Utility/Golf Kart	04-->06	BPR2ES	0.7
360	YDR-A (The DRIVE)	07-->	BPR2ES	0.7
400	YFM400 Big Bear Professional Manual	00-->06	DR8EA	0.7
400	YFM40 Big Bear Manual	07-->	DR8EA	0.7
400	YFM400FWE Kodiak	1993	DR8ES-L	0.7
400	YFM400 Kodiak Manual	94-->99	DR8EA	0.7
400	YFM400 Kodiak Auto	00-->05	DR8EA	0.7
400	YFM4FAV Kodiak Auto	2006	DR8EA	0.7
450	YFM450F Kodiak	03-->05	DR8EA	0.8
450	YFM45 Kodiak	2006	DR8EA	0.8
450	YFM45 Grizzly	07-->	DR8EA	0.8
450	YFM45 Grizzly EPS	10-->	DR8EA	0.8
450	YFZ450	03-->	CR8E	0.8
450	YFZ450R	09-->	CR8E	0.8
558	YFM550FWAD Grizzly	08-->	LMAR6A-9	0.9
600	YFM600FWA Grizzly	98-->01	DPR8EA-9	0.9
660	YFM660FWA Grizzly	02-->	DPR8EA-9	0.9
660	YFM660R Raptor	01-->05	DPR8EA-9	0.9
660	YXR660 Rhino	04-->07	DPR8EA-9	0.9
700	YXR70FX Rhino Fi	08-->	CPR7EA-9	0.8
700	YFM700R Raptor	06-->07	CR8E	0.6
700	YFM700 Grizzly Fi (19mm Thread Reach)	07-->08	CPR7EA-9	0.9
700	YFM700FWAD Grizzly Fi (26.5mm Thread Reach)	09-->	LMAR6A-9	0.9



STARTER MOTORS



Bearings

Braking

Bullbars

Cables

Carburettor

Driveline

Electrical

Exhausts

Arctic Cat



ATV City Part No.	Make	Model
290.0115	ARCTIC CAT	250 2X4 99-05, 250 4x4 01-05 300 2X4 98-03, 300 4x4 98-05
290.0125	ARCTIC CAT	375 02, 400 03-08 / FIS/ 400 4x4 TBX 04-06 400 TRV 07-13
290.0123	ARCTIC CAT	DVX400 04-08
290.0130	ARCTIC CAT	400 98-02, 500 02-07, 500 00-09 Auto 650 05-08, Prowler 650 06-07
290.0150	ARCTIC CAT	700 Diesel 07-13
290.0155	ARCTIC CAT	700 Diesel 07-13 Alternator

Honda



ATV City Part No.	Make	Model
290.0008	HONDA	TRX250 Recon 97 - 13, TRX250EX Sportrax 97-08
290.0010	HONDA	TRX300 88-00, ATC250ES 87, TRX250 87 ATC2505X 87
290.0020	HONDA	TRX350 00-06 Rancher/Fourtrax
290.0030	HONDA	TRX350 87-89, ROTATION CW
290.0035	HONDA	TRX400FA 04 - 07
290.0037	HONDA	TRX420 TE/TM/FE/FM 2007-13
290.0041	HONDA	TRX420 2014 TRX500FE/FM 2012-14 OEM REF # 31200-HR0-F01

STARTER MOTORS



Honda Cont.



ATV City Part No.	Make	Model
290.0045	HONDA	TRX400 FW 96-00 / TRX 450 S/FM 98-04 / TRX 500 FE/FM 05-11
290.0050	HONDA	TRX500FA Rubicon 01-13
290.0055	HONDA	TRX650FA Rincon 03-06 TRX680FA 06 -13

John Deere



ATV City Part No.	Make	Model
290.0510	JOHN DEERE GATOR / CUB CADET	All 1800 Golf / Turf Vehicle, Kawasaki 18HP All Gator 6x4 / Trail, Kawasaki 18HP All Gator HPX / Kawasaki 18HP / 20HP OEM JD AM109408 / Kawasaki 21163-2101
290.0255	JOHN DEERE	John Deere Gator XUV 621 4x4 23HP OEM JD MIA10971
290.0515	JOHN DEERE GATOR	Gator TH 6x4 , XUV850D , Pro Gator 2020/2030

Kawasaki



ATV City Part No.	Make	Model
290.0260	KAWASAKI	KAF 540 Mule 2010 CI 540cc KAF 540 Mule 2020 DI 540cc KAF 540 Mule 2030 EI 540cc
290.0205	KAWASAKI	KLF220 96-02 / KLF250 03-11
290.0210	KAWASAKI	KLF300B/C 88-04 / KVF300 99-02 KEF300 LAKOTA 95-03
290.0213	KAWASAKI	KVF360 OEM 21163-1328 03-07
290.0214	KAWASAKI	KVF360 2009-11

STARTER MOTORS



Kawasaki Cont.

ATV City Part No.	Make	Model
290.0215	KAWASAKI	KLF400 93-99 / KVF400 97-02
290.0123	KAWASAKI	KSF400 03-06 KLX400 03-04
290.0220	KAWASAKI	KVF650/700/750 04-13 KFX700 / KSF700 / KVF700 04-09
290.0250	KAWASAKI	KAF620 Mule 3000/3010/3020 OEM 21163-2124
290.0255	KAWASAKI	KAF 620 Mule 2500 C1-C6 617cc KAF 620 Mule 2510 4x4 A1-A6 617cc KAF 620 Mule 2520 Turf B1-B6 617cc OEM KAW 21163-2114-8
290.0260	KAWASAKI	KAF540 Mule 2010/2020/2030 oem 21163-1147
290.0270	KAWASAKI	KAF950 Mule 2510/3010/4010 Diesel OEM 21163-0030/1299
290.0275	KAWASAKI	KAF950 Mule Diesel 3010 / 4010 Alternator oem 21001-1176

Bearings

Braking

Bullbars

Cables

Carburettor

Driveline

Electrical

Exhausts



STARTER MOTORS



Kubota



ATV City Part No.	Make	Model
290.0500	KUBOTA	RTV900 – D902E-UV 21.6HPKubota Excavators K008 D722 10HP / D722EBH-3 10HP, Kubota Generator Sets GL5500S/ ZB500GLS 10HP DSL, GL6500S/ZB600GLS 12HP DSL, Kubota Tractor B215DT/E V1200-5B 24HP DSL 88-96
290.0502	KUBOTA	RTV900 / 1140 Alternator oem K7561-61910/11

Polaris



ATV City Part No.	Make	Model
290.0410	POLARIS	ATP330 2X4 04-05, ATP500HO 2X4 04-05, MAGNUM 325 00-02/330 03-05/425 95-98/500 99-03, SCRAMBLER 500 97-11, SPORTSMAN 335 99-00/400 01-05/450 06/500 96-12, TRAIL BOSS 325 00-02/330 03-06, WORKER 335 99/500 99, XPLOER 500 97, BIG BOSS 500 6X6 98-02, MAGNUM 6X6 96-97, SPORTSMAN 6X6 00-06, HAWKEYE 400 11-12, RANGER 2X4 01-09, RANGER 4X4 01-13, RANGER 6X6 98-05, SPORTSMAN 6X6 00-08
290.0415	POLARIS	SPORTSMAN 600/700/800 02-13, RANGER 700/800 05-13, RANGER 6X6 EFI 06-09 RANGER RZR 800 08-13, SPORTSMAN 6X6 09-13
290.0420	POLARIS	300/400CC 94-95 / SPORT 400 94-99/ 400 SCRAMBLER 95-02 / SPORTSMAN 400 94-97 TRAILBLAZER 250 96-06, TRAILBLAZER 400 2003, TRAIL BOSS 90-99, XPLOER 300 96-99, XPLOER 400 95-02, XPRESS 96-99 300 96-99, XPRESS 400 96-97, BIG BOSS 250/300 /350/400 6X6 89-97
290.0450	POLARIS	Starter Drive Unit Models 1985-2012, OEM 3083647 / 3085394 / 3087030 / 3089255 / 3090034
290.0425	POLARIS	Ranger 653cc TM OEM 3088464 04-06

STARTER MOTORS



Suzuki

ATV City Part No.	Make	Model
290.0105	SUZUKI	LT-Z50 QuadSport 2006-09 oem 31100-22G00/10
290.0110	SUZUKI	LT80 87-06
290.0112	SUZUKI	LT-Z90 QuadSport 2007-09 oem 31100-33G01
290.0115	SUZUKI	LTF250 87-02, LTF300 92-02
290.0120	SUZUKI	LT160 89-04 / LTF250 Ozark 02-12 / LTZ250 QuadSport 04-09
290.0123	SUZUKI	Suzuki LTZ400 Quad Sport 03-09 DRZ400 00-09 / DRZ400S 00-12 OEM 31100-29F00
290.0125	SUZUKI	LTA/LTF400 Eiger 03-06 LTA/LTF400 King Quad 08-10
290.0127	SUZUKI	LTA450 X King Quad OEM: 31100-11H00 7-10 LTA 500 King Quad 09-12
290.0129	SUZUKI	Suzuki LT-R 450 Quad Racer 06 - 09 OEM 31100-45G00
290.0130	SUZUKI	LTA/LTF500 QuadMaster 98-02 / LTA500 Vinson 02-07
290.0135	SUZUKI	LTA700X King Quad 05-07 LTA 750 King Quad 08-09
290.0220	SUZUKI	LTV700F Twin Peaks 04-05

Bearings

Braking

Bullbars

Cables

Carburettor

Driveline

Electrical

Exhausts

STARTER MOTORS



Yamaha



ATV City Part No.	Make	Model
290.0301	YAMAHA	YFM50 Raptor 04-08 / YFM80 Badger/Grizzly 86-08 / YFM80 Raptor 02-08 YFM100 Champ / Moto 85-92
290.0303	YAMAHA	YFA-1 Breeze 89-04 / YFM125 Grizzly 04-13
290.0305	YAMAHA	YFM225 MOTO - 4 86-88, YFM250 BEARTRACKER 99, YFM250 MOTO - 4 89-91 YFM250 BIG BEAR 06-09
290.0310	YAMAHA	YFM200 MOTO 85-90, YTM200E MOTO, YTM225DX TRI-MOTO, YFB250 TIMBERWOLF 92-00, YFM250 BEARTRACKER 00-04
290.0330	YAMAHA	YFM350 RAPTOR 04-13, YFM350X WARRIOR 04, YFM350FW BIG BEAR 87-99, YFM400 KODIAK 93-99, YFM350 RAPTOR 04-06
290.0335	YAMAHA	YFM350 Bruin 04-06, YFM 350 GRIZZLY 07-13, YFM350 WOLVERINE 06-09
290.0340	YAMAHA	YFM400 Kodiak 00-06 / YFM450 Kodiak 03-06 / YXR660F Rhino 04-07/450 RHINO 06-09, YFM400 GRIZZLY 07-08/YFM450 GRIZZLY 07-10/YFM600/660 GRIZZLY 98-08, YFM450 WOLVERINE 07-10
290.0315	YAMAHA	YFM350FWB 97-98 / YFM400 BIGBEAR 00-12/YFM400 KODIAK 99 OEM: 4KB-81800-00-00/YFM350FX WOWERINE 95-03
290.0340	YAMAHA	YFM700 GRIZZLY 06-08, YFM700 RAPTOR 07-12, YXR700 RHINO 08-13, YFM600 Grizzly 600 98-01, YFM660 Grizzly 660 02-08, YFM400 Kodiak 00-06, YFM450 Kodiak 03-06, YFM450 Wolverine 07-10, YXR450 Rhino 06-09, YXR660 Rhino 04-07, oem Ref 4WV-81800-00-00 / 4WV-81890-00-00 / 5KM-81890-00-00
290.0345	YAMAHA	YFM450 Grizzly 2011-12 oem 1CT-81890-00-00
290.0350	YAMAHA	YFM550/700FG Grizzly 09-12 oem Ref #28P-81890-00-00
290.0360	YAMAHA	YFM700 GRIZZLY 06-08, YFM700 RAPTOR 07-12, YXR700 RHINO 08-13

Please note - The following will NOT be covered by warranty - Units with oil , Water or Dirt Damage . Also we will not warrant units with broken , Badly worn shafts , broken drive-end housings or units that are burnt out. We recommend that the meshing gear is renewed at the same time as the starter.

GEAR SHIFT MOTORS



Bearings

Braking

Bullbars

Cables

Carburettor

Driveline

Electrical

Exhausts

Honda Gear Shift Motors



ATV City Part No.	Make	Oem Ref
291.0010	Honda TRX350ES 2000-06	31300-HN5-A11
291.0025	Honda TRX420FE 2007-13	31300-HP5-601
291.0050	Honda TRX450ES 1998-04	31300-HN0-A12
291.0100	Honda TRX500FA 2001-13	31300-HN2-003
291.0200	Honda TRX500FE 2005-09	31300-HP0-A11

Honda Angle Sensors

ATV City Part No.	Make	Oem Ref
291.5000	Honda TRX250TE 02-13 TRX350TE/FE 04-06 TRX420 TE/FE 07-14 TRX500FE 05-13	38800-HP0-A11
291.5050	Honda TRX350TE/FE 02-03 TRX450FE 02-04 TRX420FA1/FE1 2014 TRX420FA1/FE2 2014	38800-HR3-A21



STARTER BRUSH KITS



Brush kits



ATV City Part No.	Make	Model
295.0005	ARCTIC CAT	250 2X4 99-05, 250 4X4 01-05, DVX250 06, 300 2/4WD 98-02
	HONDA	TRX250TM 97-07, TRX300 88-00, TRX350FM 00-07, TRX400FM 95-00, TRX450S/ES/FM 98-04, TRX500FA 04-07
	KAWASAKI	KLF300A/B/C, KLF400, KVF300/400/650/700/750
	SUZUKI	LT160, LTF160, LT-F250 88-05, LT-4WD 87-98 LT-F4WDX 91-98, L-F300F 99-02
	YAMAHA	YFM350 BRUIN 05
295.0010	HONDA	ATC250ES 85-87, ATC250SX, TRX250 85-87
	YAMAHA	YFM350 BIGBEAR
295.0015	HONDA	TRX200 90-91, TRX200D 91-97, TRX300EX 93-06, TRX350D 87-89 (2-BRUSH MITSUBA MODELS)
295.0018	HONDA	TRX 420 07-13 31201-MEW-921 / 31202-MEW-921 TRX250 RECON 08-13 (requires 1 brush to be cut off)
	SUZUKI	LTA/LTF400 10-12 31132-38F10
295.0020	SUZUKI	LTF/LTA400 Eiger 02-07 LTF/LTA400 King Quad 08-10 LTA450 / 500 King Quad 07-13
295.0025	HONDA	ATC250SX 87, TRX350 86-89 (4-BRUSH TYPE)
295.0030	YAMAHA	YFM80/100
295.0035	YAMAHA	YFA1 Breeze / YFM125 Grizzly
295.0040	YAMAHA	YFM200 Moto 87-90 / YFM250 Beartracker 00-04 / YFB250 Timberwolf 99-02
295.0045	KAWASAKI	KFX80
	SUZUKI	LT80
295.0065	KAWASAKI	KAF300 MULE 500/520/550, KAF540 MULE 2010/2020/2030, KAF620 MULE 2500/2510/2500



Bearings

Braking

Bullbars

Cables

Carburettor

Driveline

Electrical

Exhausts

STARTER BRUSH KITS



Brush kits

ATV City Part No.	Make	Model
295.0070	POLARIS	Xpedition 325/425 00-02
	SUZUKI	LTF/LTA500 QuadMaster LTA500 Vinson
	YAMAHA	YFM400/450 Kodiak 00-05 / YFM600/660 Grizzly 98-05 / YXR660F Rhino 04-05
295.0075	POLARIS	ATP330/500 04-05 / ATV Pro 500 02 / BigBoss 98-02 / Magnum 325/330/500/6x6 95-03 Ranger 98-05 / Scrambler 500 97-06 / Sportsman
295.0080	KAWASAKI	KLF220 88-95
295.0085	KAWASAKI	KLF220/250 96-06
295.0050		2-WIRE STARTER BRUSH
295.0055		SINGLE STARTER BRUSH
295.0060		SINGLE POLE STARTER BRUSH



INSULATION TAPE



Insulation Tape

ATV City Part No.	Description
120.0400	Insulation Tape (10 per pack)



CIGARETTE PLUG



Cigarette Plug

ATV City Part No.	Description
120.0370	Male Acc Cigarette plug 12v 15amp
120.0375	12V/10A Socket for Power Supply - Cig type - Carrier Mounted or will fit straight into as TRX replacement



SOLENOID RELAYS



Solenoids

ATV City Part No.	Make	Model
298.0010	HONDA	TRX300 88-92 OEM # 35850-HC4-000
	YAMAHA	YFM200-350 BIGBEAR/KODIAK OEM # 4KD-81940, 3AY-81940-00, 22U-81940
298.0015	HONDA	TRX350 00-06, TRX450 98-04/TRX500 06-14 OEM# 35850-HN0/HF1/HN2
298.0020	HONDA	TRX420 07-13 OEM # 35850-HP5-600
298.0050	YAMAHA	YFM Solenoids 2004-2010 OEM 5JW-81940



HORNS



Horns

	Make	ATV City Part No.
	Replacement 12V Horn	120.0185



SECURITY



Tracker Retrieve

ATV City Part No.	Model
120.0800	Tracker battery powered device. No external power needed, ideal for ATV's, Horse Box's, Trailer etc. Compatible across most of the UK. Call for details

SPOT LIGHTS



ATV Mounted Spot Light

ATV City Part No.	Model
120.0750	12V 55w Handle Bar or Carrier Mountable Spot Light, Turns, Swivels with Detachable Head. Great for lambing or lamping.

ELECTRONIC CLEANERS

CRC Electric Cleaners



ATV City Part No.	Model
210.0054	CRC Electronic Cleaner 200ml Removes Oil, Dirt & Dust from electronic components on printed circuit boards, connectors, relays and switches. Leaves no residue.
210.0065	Battery Pole Protector 200ml Prevents sulfating on battery connectors and poles. Quick drying it avoids the sticking on of dust and dirt.
210.0490	Kontakt 60 200ml Contact de-oxidiser. Dissolves corrosion wayers, restoring the metal contact. Optimum contact conditions are reached when residue's dissolved using Kontakt 60 prior to protection with Kontakt 61.
210.0500	Kontakt 61 200ml Contact lubricant & corrosion inhibitor. Builds a thin protective film, preventing corrosion and wear. Provides a low, stable contact resistance, without leakage currents or short circuits between the contact surfaces.



IGNITION KEY SWITCHES



Universal Ignition Key Switch

159.0010	2 Position Switch	Wire Lenth 240mm	2 Keys / 4-Pin plug
----------	-------------------	------------------	---------------------



(Sample Picture)

Yamaha Ignition Switch's

ATV City P/N	Fitment	Year	OEM Ref #
159.2005	YFA1 / YFM125	02 +	5LP-82510-00-00
	YFM125 Raptor	2011	5LP-82510-00-00
	YFM250R Raptor	08 +	5LP-82510-00-00
	YFM350 Bruin	04-06	5LP-82510-00-00
	YFM350 Grizzly	07 +	5LP-82510-00-00
	YFM350 Wolverine	02 +	5LP-82510-00-00
	YFM350 Warrior	02-04	5LP-82510-00-00
	YFM660R Raptor	01-05	5LP-82510-00-00
159.2010	YFM700R Raptor	06-08	5LP-82510-00-00
	YFM50R Raptor	04-08	4GB-82510-11-00
	YFM80	95-08	4GB-82510-11-00
	YFA1 Breeze	95-01	4GB-82510-11-00
	YFM250X Bear Tracker	99-01	4GB-82510-11-00
	YFB250 Timberwolf	94-00	4GB-82510-11-00
	YFM350 Moto 4	1995	4GB-82510-11-00
	YFM350 Big Bear	95-99	4GB-82510-11-00
	YFM350FX Wolverine	95-01	4GB-82510-11-00
	YFM350X Warrior	96-01	4GB-82510-11-00
	YFM400 Big Bear	00-01	4GB-82510-11-00
	YFM400 Kodiak	93-01	4GB-82510-11-00
159.2015	YFM600 Grizzly	98-01	4GB-82510-11-00
	YFM400 Grizzly	07-08	5ND/5TG-82510-00-00
	YFM450 Grizzly	07 +	5ND/5TG-82510-00-00
	YFM400 Kodiak	03-06	5ND/5TG-82510-00-00
	YFM450 Kodiak	03-06	5ND/5TG-82510-00-00
	YFM450 Wolverine	06-10	5ND/5TG-82510-00-00
	YFZ450 / YFZ450X	04-09	5ND/5TG-82510-00-00
	(Will not fit 09+ YFZ450R)		

IGNITION KEY SWITCHES



(Sample Picture)

Yamaha Ignition Switch Cont.

ATV City P/N	Fitment	Year	OEM Ref #
159.2020	YFM660 Grizzly	02 +	5KM-82510-00-00
	YFM400 Kodiak	2002	5KM-82510-00-00
	YFM400 Big Bear	09-11	5KM-82510-00-00
	YFM350 Grizzly	09-11	5KM-82510-00-00

RADIATOR FANS / MOTORS

Arctic Cat ATV

ATV City Part No.	Eng	Model No	Year	OEM Ref
570.1019	375	375 2x4 / 4x4 w/AT	2002	0413-123
570.1019	400	400 4x4	2002 - 04	0413-123
570.1019	400	400 FIS/TBX/VP 2x4 / 4x4	2003 - 07	0413-123
570.1019	450	450i EFI / H1 / TRV / XC	2010 - 12	0413-123
570.1019	500	500 4x4 w/AT	2002	0413-123
570.1019	500	500 EFI 4x4 A/T	2013	0413-123
570.1019	500	500 FIS 4x4 w/AT	2002 - 09	0413-123
570.1019	500	500 FIS 4x4 w/MT	2002 - 09	0413-123
570.1019	500	500 FIS TBX 4x4	2002 - 06	0413-123
570.1019	500	500 FIS TRV 4x4	2003 - 08	0413-123
570.1019	550	550 EFI / GT / TRV / XT 4X4	2012 - 13	0413-123
570.1019	550	550 H1 / TRV / FIS 4X4	2009 - 11	0413-123
570.1019	650	650 4x4 H1	2005 - 12	0413-123
570.1019	650	650 4x4 w/AT V2	2004 - 06	0413-123
570.1019	700	700 Diesel	2008 - 13	0413-123
570.1019	700	700 EFI / H1 / GT / LTD / XT / TRV 4x4	2006 - 13	0413-123
570.1019	1000	1000 Cruiser / TRV / XT / GT	2012 - 13	0413-123
570.1019	1000	H2 MUDPRO	2010 - 11	0413-123
570.1019	1000	H2 THUNDERCAT	2008 - 11	0413-123



RADIATOR FANS / MOTORS



Arctic Cat UTV

ATV City Part No.	Eng	Model No	Year	OEM Ref
570.1019	550	550 Prowler	2009 - 13	0413-123
570.1019	650	650 Prowler	2006 - 09	0413-123
570.1019	700	700 Prowler	2008 - 13	0413-123
570.1019	1000	1000 Prowler XTZ	2009 - 13	0413-123
570.1019	1000	Wildcat	2012 - 13	0413-123

Can-Am ATV

ATV City Part No.	Eng	Model No	Year	OEM Ref
570.1018	400	Outlander 400	2006 - 08	709-200-158
570.1017	400	Outlander 400	2009 - 14	709-200-332 / 709-200-371
570.1003	500	Outlander 500	2007 - 08	2410123
570.1017	500	Outlander 500	2009 - 12	709-200-332 / 709-200-371
570.1003	500	Renegade 500	2008	2410123
570.1017	500	Renegade 500	2009 - 12	709-200-332 / 709-200-371
570.1003	650	Outlander 650	2006 - 08	2410123
570.1017	650	Outlander 650	2009 - 12	709-200-332 / 709-200-371
570.1003	800	Outlander 800	2006 - 08	2410123
570.1017	800	Outlander 800	2009 - 12	709-200-332 / 709-200-371
570.1003	800	Renegade 800	2007 - 08	2410123
570.1017	800	Renegade 800	2009 - 11	709-200-332 / 709-200-371
570.1006	1000	Outlander 1000 XMR	2013	2410288 / 2410413

RADIATOR FANS / MOTORS



Honda ATV

ATV City Part No.	Eng	Model No	Year	OEM Ref
570.1013	400	TRX400FGA Fourtrax Rancher 4X4	2004 - 07	19030-HN2-013 / 19030-HN7-013 / 19030-HP0-A01 / 19030-HP0-B01
570.1012	420	TRX420 FA/FPA	2009 - 14	19020-HN2-003 / 19030-HN2-B01 / 19030-HP5-601
570.1012	420	TRX420 FE/FM/TE/TM	2007 - 13	19020-HN2-003 / 19030-HN2-B01 / 19030-HP5-601
570.1013	500	TRX500FA	2001 - 04	19030-HN2-013 / 19030-HN7-013 / 19030-HP0-A01 / 19030-HP0-B01
570.1014	500	TRX500FA	2005 - 07	19030-HN2-A21
570.1012	500	TRX500FA	2008 - 14	19020-HN2-003 / 19030-HN2-B01 / 19030-HP5-601
570.1013	500	TRX500FE/FM	2005 - 11	19030-HN2-013 / 19030-HN7-013 / 19030-HP0-A01 / 19030-HP0-B01
570.1012	500	TRX500FE/FM	2012 - 13	19020-HN2-003 / 19030-HN2-B01 / 19030-HP5-601
570.1013	650	TRX650 Rincon	2003 - 05	19030-HN2-013 / 19030-HN7-013 / 19030-HP0-A01 / 19030-HP0-B01
570.1013	680	TRX680 Rincon	2006 - 12	19030-HN2-013 / 19030-HN7-013 / 19030-HP0-A01 / 19030-HP0-B01

Kawasaki ATV

ATV City Part No.	Eng	Model No	Year	OEM Ref
570.1008	650	KVF650 I Brute force	2006 - 13	59502-0011
570.1008	750	KVF750 Brute Force	2005 - 11	59502-0011
570.1016	750	KVF750 Brute Force / EPS	2012 - 14	59502-0554

Kawasaki UTV

ATV City Part No.	Eng	Model No	Year	OEM Ref
570.1029	750	TERYX 750 4X4	2010 - 13	59502-0047 / 59502-0564



RADIATOR FANS / MOTORS



Polaris ATV

ATV City Part No.	Eng	Model No	Year	OEM Ref
570.1002	250	Trail Blazer 250	1996 - 97	4170009 / 4170011 / 4170013
570.1002	250	Xplorer 250 4X4	2000 - 02	4170009 / 4170011 / 4170013
570.1010	325	Magnum 325	2000 - 02	2410157
570.1010	325	Trail Boss 325	2000 - 02	2410157
570.1010	325	Xpedition 325	2001 - 02	2410157
570.1010	330	ATP 330 4X4	2004	2410157
570.1010	330	Magnum 330	2003 - 04	2410157
570.1010	330	Trail Boss 330	2003 - 04	2410157
570.1002	350	350L	1993	4170009 / 4170011 / 4170013
570.1001	350	Sportsman 350 4x4	1993	2410006 / 3084266 / 3084267 / 4170009
570.1001	350	Trail Boss 350L	1990 - 92	2410006 / 3084266 / 3084267 / 4170009
570.1024	400	Hawkeye 400 HO 2x4	2012 - 14	2411330
570.1030	400	Scrambler 400 2x4	2000 - 02	2410123
570.1001	400	Scrambler 400 4x4	1995	2410006 / 3084266 / 3084267 / 4170009
570.1002	400	Scrambler 400 4x4	1996 - 97	4170009 / 4170011 / 4170013
570.1002	400	Scrambler 400 4x4	1999 - 00	4170009 / 4170011 / 4170013
570.1030	400	Scrambler 400 4x4	2001 - 02	2410123
570.1001	400	Sport 400	1995	2410006 / 3084266 / 3084267 / 4170009
570.1002	400	Sport 400	1996 - 99	4170009 / 4170011 / 4170013
570.1001	400	Sportsman 400 4x4	1994 - 95	2410006 / 3084266 / 3084267 / 4170009
570.1002	400	Sportsman 400 4x4	1997	4170009 / 4170011 / 4170013
570.1030	400	Sportsman 400 4x4	2001 - 04	2410123
570.1004	400	Sportsman 400 4X4 AQ-AV	2004	2410383
570.1004	400	Sportsman 400 4X4	2005	2410383
570.1025	400	Sportsman 400 HO 4x4	2008 - 10	2520850
570.1004	400	Sportsman 400 HO 4x4	2011	2410383
570.1024	400	Sportsman 400 HO 4x4	2012 - 14	2411330
570.1030	400	Trail Blazer 400	2003	2410123
570.1001	400	Xplorer 400L 4x4	1995	2410006 / 3084266 / 3084267 / 4170009
570.1002	400	Xplorer 400L 4x4	1997 - 02	4170009 / 4170011 / 4170013

RADIATOR FANS / MOTORS



Polaris ATV (continued)

ATV City Part No.	Eng	Model No	Year	OEM Ref
570.1002	400	Xpress 400L 2x4	1997	4170009 / 4170011 / 4170013
570.1001	425	Magnum 425 2x4 / 4X4	1995	2410006 / 3084266 / 3084267 / 4170009
570.1002	425	Magnum 425 2x4 / 4X4	1997 - 98	4170009 / 4170011 / 4170013
570.1030	425	Xpedition 425	2000 - 02	2410123
570.1004	450	Sportsman 450	2006 - 07	2410383
570.1030	455	Diesel 455 4x4	2000 - 01	2410123
570.1002	455	Diesel 455 4x4	1999	4170009 / 4170011 / 4170013
570.1030	500	ATP 500 4X4	2004	2410123
570.1004	500	ATP 500 4X4	2005	2410383
570.1002	500	Magnum 500 2x4 HDS	2002	4170009 / 4170011 / 4170013
570.1002	500	Magnum 500 4x4	1999	4170009 / 4170011 / 4170013
570.1030	500	Magnum 500 4x4	2000 - 03	2410123
570.1002	500	Scrambler 500 2x4	2000	4170009 / 4170011 / 4170013
570.1030	500	Scrambler 500 2x4	2002	2410123
570.1002	500	Scrambler 500 4x4	1997 - 00	4170009 / 4170011 / 4170013
570.1002	500	Scrambler 500 4x4	1999 - 00	4170009 / 4170011 / 4170013
570.1030	500	Scrambler 500 4x4	2001 - 03	2410123
570.1002	500	Sportsman 500 4x4	1996 - 99	4170009 / 4170011 / 4170013
570.1030	500	Sportsman 500 4x4	2000	2410123
570.1030	500	Sportsman 500 4x4 DUSE	2001 - 02	2410123
570.1030	500	Sportsman 500 4x4 HO	2001 - 03	2410123
570.1030	500	Sportsman 500 4x4 HO AA- AC- AE- AG	2004	2410123
570.1004	500	Sportsman 500 4x4 HO AO - AX	2004	2410383
570.1004	500	Sportsman 500 4x4 HO	2005 - 11	2410383
570.1024	500	Sportsman 500 4x4 HO	2012 - 13	2411330
570.1030	500	Sportsman 500 4x4 RSE	2000 - 02	2410123
570.1002	500	Sportsman 500 4x4 RSE	1999	4170009 / 4170011 / 4170013
570.1004	500	Sportsman 500 EFI	2009 - 10	2410383
570.1004	500	Sportsman 500 X2	2006 - 09	2410383
570.1004	500	Sportsman Forest 500	2011	2410383
570.1024	500	Sportsman Forest 500	2012 - 13	2411330
570.1004	500	Sportsman Forest Tractor 500	2011	2410383
570.1024	500	Sportsman Forest Tractor 500	2012	2411330
570.1004	500	Sportsman Touring 500 EFI	2008 - 10	2410383
570.1024	500	Sportsman Touring 500 EFI	2011 - 13	2411330



RADIATOR FANS / MOTORS



Polaris ATV (continued)

ATV City Part No.	Eng	Model No	Year	OEM Ref
570.1030	500	Worker 500 4x4	2000 - 02	2410123
570.1002	500	Worker 500 4x4	1999	4170009 / 4170011 / 4170013
570.1002	500	Xplorer 500	1997	4170009 / 4170011 / 4170013
570.1024	570	Sportsman 570	2014	2411330
570.1006	600	Sportsman 600 4x4	2003 - 05	2410288 / 2410413
570.1006	700	Sportsman 700 4x4	2002 - 07	2410288 / 2410413
570.1006	700	Sportsman MV7	2005	2410288 / 2410413
570.1006	700	Sportsman X2 700 EFI	2008	2410288 / 2410413
570.1006	800	Sportsman 800 EFI	2005 - 13	2410288 / 2410413
570.1006	800	Sportsman Forest 800 EFI	2012 - 14	2410288 / 2410413
570.1006	800	Sportsman Touring 800 EFI	2008 - 09	2410288 / 2410413
570.1006	800	Sportsman X2 800 EFI	2007 - 09	2410288 / 2410413

Polaris UTV

ATV City Part No.	Eng	Model No	Year	OEM Ref
570.1002	400	Big Boss 400L 6x6	1994 - 97	4170009 / 4170011 / 4170013
570.1002	400	Magnum 400L 6x6	1997	4170009 / 4170011 / 4170013
570.1023	400	Ranger 4x4 400	2010 - 14	2410340 / 2410865
570.1002	500	Big Boss 500 6x6	1998 - 99	4170009 / 4170011 / 4170013
570.1023	500	Ranger 2X4 500	2008 - 09	2410340 / 2410865
570.1023	500	Ranger 4X4 500	2004 - 13	2410340 / 2410865
570.1023	500	Ranger 4x4 500 Crew	2011 - 13	2410340 / 2410865
570.1023	500	Ranger 6X6 500	2004	2410340 / 2410865
570.1030	500	Sportsman 500 6x6	2000 - 03	2410123
570.1006	570	Ranger RZR 570 EFI	2012 - 14	2410288 / 2410413
570.1006	700	Ranger 4x4 700	2006 - 09	2410288 / 2410413
570.1006	700	Ranger 4x4 700 CREW	2008 - 09	2410288 / 2410413
570.1006	700	Ranger 6x6 700 EFI	2006 - 09	2410288 / 2410413
570.1006	800	Ranger 4x4 800 EFI	2010	2410288 / 2410413
570.1006	800	Ranger 4x4 800 EFI CREW	2010	2410288 / 2410413
570.1006	800	Ranger 6X6 800	2010	2410288 / 2410413

RADIATOR FANS / MOTORS



Polaris UTV (continued)

ATV City Part No.	Eng	Model No	Year	OEM Ref
570.1006	800	RANGER RZR 4 800	2011 - 14	2410288 / 2410413
570.1006	800	RANGER RZR S 800	2009 - 14	2410288 / 2410413
570.1006	800	RZR 800	2008 - 13	2410288 / 2410413
570.1006	800	Sportsman 800 EFI 6x6	2009 - 13	2410288 / 2410413
570.1006	800	Sportsman Forest 800 6x6	2013	2410288 / 2410413

Yamaha ATV

ATV City Part No.	Eng	Model No	Year	OEM Ref
570.1011	400	YFM400 Big Bear 2WD	2000 - 04	5FU-E2405-00-00
570.1011	400	YFM400 Big Bear 4WD	2000 - 06	5FU-E2405-00-00
570.1028	400	YFM400 Grizzly IRS	2007 - 08	5ND-E2405-00 / 5ND-E2405-01-00
570.1005	400	YFM400 Kodiak 2WD	2000 - 01	5GH-12405-00-00
570.1028	400	YFM400 Kodiak 2WD	2003 - 04	5ND-E2405-00 / 5ND-E2405-01-00
570.1005	400	YFM400 Kodiak 4WD	2000 - 01	5GH-12405-00-00
570.1028	400	YFM400 Kodiak 4WD	2003 - 06	5ND-E2405-00 / 5ND-E2405-01-00
570.1028	450	YFM450 Grizzly IRS	2007 - 14	5ND-E2405-00 / 5ND-E2405-01-00
570.1028	450	YFM450 Kodiak	2003 - 06	5ND-E2405-00 / 5ND-E2405-01-00
570.1028	450	YFM45FX Wolverine 450 4X4	2006 - 10	5ND-E2405-00 / 5ND-E2405-01-00
570.1027	550	YFM550 Grizzly	2009 - 11	3B4-12405-00-00
570.1027	700	YFM700 Grizzly	2007 - 11	3B4-12405-00-00

Yamaha UTV

ATV City Part No.	Eng	Model No	Year	OEM Ref
570.1007	450	450 RHINO	2006 - 09	5UG-E2405-00-00
570.1007	660	660 RHINO	2004 - 07	5UG-E2405-00-00
570.1009	700	700 RHINO FI	2008 - 13	5B4-E2405-00-00



RADIATOR FANS / MOTORS



570.1001



570.1002



570.1003



570.1004



570.1005



570.1006



570.1007



570.1008



570.1009



570.1010



570.1011



570.1012



570.1013



570.1014



570.1016



570.1017



570.1018



570.1019



570.1020



570.1023



570.1024



570.1025



570.1027



570.1028



570.1029



570.1030



RFM5500

Bearings

Braking

Bullbars

Cables

Carburettor

Driveline

Electrical

Exhausts



the best part of your atv

- 1: BEARINGS, BUSH KITS, BALLJOINTS
- 2: BRAKING
- 3: BULLBARS, MUDFLAP KITS
- 4: CABLES
- 5: CARBURETTOR PARTS
- 6: DRIVE LINE / CVT BELTS / AXLES
- 7: ELECTRICAL
- 8: EXHAUSTS
- 9: MISCELLANEOUS
- 10: FILTERS
- 11: SEAT COVERS, OVER COVERS
- 12: TOOLS
- 13: TYRES / TUBES / RIMS
- 14: ENGINE COMPONENTS
- 15: SPRAYERS & SPRAYER ACCESSORIES



8: EXHAUSTS

EXHAUSTS



Honda

Exhaust ATV City Part No.	Gasket ATV City Part No.	Clamp ATV City Part No.	Model
130.MH359	130.MG3732	130.MC40	ATC250ES 85-88
130.MH463	130.MG3532	130.MC37	TRX250 Recon 97-98
130.MH466	130.MG3732	130.MC40	TRX250 85-89
130.MH468			TRX300 / FW 88-92
130.MH470			TRX300 / FW 93-00
130.MH469	130.MG4035	130.MC43	TRX350 G-P 86-93
130.MH069			TRX350 G-P 86-93 Header Pipe
130.MH473	130.MG3732	130.MC40	TRX350 ES/FM 00-06
130.MH480	130.MG4135	130.MC44	TRX400 FW 96-05
130.MH483	130.MG4238	130.MC44	TRX400FA 04
130.MH477			TRX420 FM/TM 07-12
130.MH479			TRX400FW/450 Heat Shield
130.MH481	130.MG4135	130.MC44	TRX450 ES/FE/FM 98-04
130.MH482	130.MG4035	130.MC43	TRX500 Foreman 05-08



Kawasaki

Exhaust ATV City Part No.	Gasket ATV City Part No.	Clamp ATV City Part No.	Model
130.MK443	130.MG3832	130.MC41	KLF220 A 89-97
130.MK448	130.MG3832	130.MC41	KLF300 B 2WD 89-04
130.MK439	130.MG3832	130.MC41	KLF300 C 4x4 Expansion Box
130.MK449	130.MG3832	130.MC41	KLF300 C 4x4 89-05
130.MK453	130.MG4035	130.MC43	KVF300/400 98-00
130.MK455	130.MG4235	130.MC45	KVF360 01-12
130.MK450	130.MG4235	130.MC45	KLF400 92-98
130.MK461	130.MG3832	130.MC40	KVF650 (Auto) 02-onwards
130.MK056	130.MG3832	130.MC40	KVF650 (Auto) Header Pipe
130.MK461	130.MG3832	130.MC40	KVF700 4x4 06
130.MK444			KAF950 Mule 00-12 2510/3010/4010 Diesel

Suzuki

Exhaust ATV City Part No.	Gasket ATV City Part No.	Clamp ATV City Part No.	Model
130.MS489	130.MG3632	130.MC40	LTF250 Ozark 02-12
130.MS491	130.MG3632	130.MC39	LTF250L 2wd/4wd Quad Runner 91-Onwards
130.MS491	130.MG3632	130.MC39	LTF300 King Quad 91-Onwards
130.MS493	130.MG3832	130.MC40	LTF400 Eiger 01-06



EXHAUSTS



Yamaha

Exhaust ATV City Part No.	Gasket ATV City Part No.	Clamp ATV City Part No.	Model
130.MY040	130.MG3732	130.MC40	YFB250 4x4 Header Pipe 94
130.MY443	130.MG3329	130.MC36	YFM225 / 250 86-92
130.MY444	130.MG3732	130.MC40	YFB250 Timberwolf 92-94
130.MY442	130.MG3832	130.MC42	YFM250XL Beartracker 99
130.MY446	130.MG3832	130.MC41	YFM350 Big Bear 89-99
130.MY446	130.MG3832	130.MC41	YFM350 SE 04-06
130.MY446	130.MG3832	130.MC41	YFM400 Kodiak Manual 98-03
130.MY447	130.MG3832	130.MC41	YFM400 FWAN 4wd Kodiak Ultramatic 99-02
130.MY447	130.MG3832	130.MC41	YFM400 A9 2wd 01-08
130.MY447	130.MG3832	130.MC41	YFM450 Kodiak 01-10
130.MY450	130.MG4642	130.MC49	YFM600 Grizzly 98-01
130.MY452	130.MG4642	130.MC49	YFM600 FWAK Grizzly 97-98
130.MY455	130.MG4642	130.MC49	YFM660 FAT Grizzly 02-06
130.MY456			YFM700 Grizzly



CRC Exhaust Repair Bandage

ATV City Part No.	Size	Description
210.0350	Package Size 130cm	For reparation of large holes and cracks in exhaust systems. Quick and easy to use without welding and/or disassembly. The bandage starts hardening while driving. To reinforce the bandage or to repair small holes, use CRC Exhaust Repair Gum



CRC Exhaust Mounting Paste

ATV City Part No.	Size	Description
210.0360	Package Size – Tube 150g	Mounting and sealing paste for all exhaust components. Facilitates assembly and disassembly and seals at the same time. Apply the paste before mounting ; the hardening will take place automatically by the exhaust heat.



CRC Exhaust Repair Gum

ATV City Part No.	Size	Description
210.0365	Package Size – Tin Can 200g	For the repair of small holes and cracks in exhaust or catalyst systems. Quick and easy to use without welding and/or disassembly. The putty hardens completely after a few minutes drive. For the repair of large holes, use CRC Exhaust Repair Bandage.





the best part of your atv

- 1: BEARINGS, BUSH KITS, BALLJOINTS
- 2: BRAKING
- 3: BULLBARS, MUDFLAP KITS
- 4: CABLES
- 5: CARBURETTOR PARTS
- 6: DRIVE LINE / CVT BELTS / AXLES
- 7: ELECTRICAL
- 8: EXHAUSTS
- 9: MISCELLANEOUS
- 10: FILTERS
- 11: SEAT COVERS, OVER COVERS
- 12: TOOLS
- 13: TYRES / TUBES / RIMS
- 14: ENGINE COMPONENTS
- 15: SPRAYERS & SPRAYER ACCESSORIES



9: MISCELLANEOUS

ACCESSORIES



DIY puncture repair kit

ATV City Part No.	Description
120.0060	No need to take the tyre off the rim anymore. Comes with all the tools and enough strings for 7 punctures



Replacement strings

ATV City Part No.	Description
120.0065	Replacement puncture repair strings 50 per box



Tyre Puncture preventer

ATV City Part No.	Description
120.0250	Tyre Puncture Preventer 473cc bottle



Cable ties

ATV City Part No.	Size	Pack Quantity
120.0085	203 x 4.6	100 PIECES
120.0090	368 x 4.8	100 PIECES
120.0100	100 x 2.5	100 PIECES
120.0105	292 x 3.6	100 PIECES



Bungees

ATV City Part No.	Size	Description
120.0550	15"	EPDM Rubber Bungee with 2 hooks
120.0555	21"	EPDM Rubber Bungee with 2 hooks
120.0560	9"	EPDM Rubber Bungee with 2 hooks
120.0565	31"	EPDM Rubber Bungee with 2 hooks



ACCESSORIES



Dog mat

ATV City Part No.	Description
120.71655	Universal fitting, durable rubber mat with unique, non-slip rubber compound



Handlebar mittens

ATV City Part No.	Description
120.0070 (Black)	Keep your hands warm with our specially fitted handlebar mittens. Also see heated handlebar grips, p.7-2
120.0072 (Red-black)	

Plastic fasteners

ATV City Part No.	Description
120.0190	Having trouble with metal fasteners rusting then change them for plastic ones. Only £25 for 100 nuts and 100 bolts.
120.0195	Honda Type Fender Rivets (come in pack 10) OEM REF 90653-HC4-900



Heated handle bar grips

ATV City Part No.	Description
392.0010	Complete with thumb warmer and two heat settings.



Fuel line / Fuel Line Clamps

ATV City Part No.	Description
120.0183	PVC Clear fuel line 8mm x 10m roll
120.0184	10-12mm Hose Clamp. Ideal for Fuel Lines (Pack of 10)



Inline fuel filter

ATV City Part No.	Description
120.0180	1/4" Inline fuel filter 2" long. Helps to prevent debris and foreign particles getting into your carburettor.



ACCESSORIES



Tow balls / Tow hitch



ATV City Part No.	Description
120.0050	Tow Ball 50mm x 3/4" shaft Chrome (For ATV's)
120.0047	Tow Ball 50mm x 1" shaft Chrome (For UTV's)
120.0035	YFM550/700 Heavy Duty Tow Hitch Assembly
120.0040	YFM450 2012 Heavy Duty Tow Hitch Assembly
120.0045	Trailer Bar Hitch Assembly to suit 1 1/4" Receiver
120.0052	Trailer Bar Hitch Assembly to suit 2" Receiver

Tie-downs



ATV City Part No.	Description
120.0015	Tie Down Mini Ratchet Type 800kg x 3m (With S-Hooks On)
120.0020	Tie Down Ratchet Type 1500kg x 6m
120.0025	Tie Down Ratchet Type 3000kg x 6m
120.0030	Tie Down Ratchet Type 5000kg x 10m
120.0033	Tie Down Ratchet Type 5000kg x 18m

Shock absorbers



ATV City Part No.	Description
235.0005	TRX400 FW 95-03 Front
235.0010	TRX400 FW 95-03 Rear
235.0015	TRX450 S / FM 98-04 Front
235.0020	TRX450 S / FM 98-04 Rear
235.0025	TRX500FM5 Front
235.0030	TRX500FM5 Rear

Gun rack kit



ATV City Part No.	Description
120.0300	Sure Grip Basic Gun Rack Kit Fits any type of ATV , Sports Vehicle and carries Guns, Bows & fishing rods securely on handle bars or frt and rear racks

Universal windscreens



ATV City Part No.	Description
120.0210	Quality units made in the USA - Windscreen with headlight cut out
120.0200	Quality units made in the USA - Windscreen without headlight cut out

ACCESSORIES



Gear shift levers

ATV City Part No.	Description	
100.0085	TRX250TM Recon 97-12	24701-HM8-000
100.0086	TRX300 88-00	24700-HM5-850
100.0090	TRX350 FM/TM 00-06	24700-HN5-670
100.0093	TRX420 FM/TM 07-13	24700-HP5-305
100.0095	TRX500FM	24700-HP0-A00
100.0082	KLF250 / 300 B/C	



ATV bike cover

ATV City Part No.	Description
120.0350	ATV Bike Cover XL



Mirror/mirror mount

ATV City Part No.	Description
120.0220	Universal 10mm Mirror - Swivel head for L/H or R/H use
120.0230	Universal Mirror mount 10mm



Tax disc holder

ATV City Part No.	Description
120.0175	Tax Disc Holder



Universal Indicators

ATV City Part No.	Description
120.0240	Indicators Universal E-Marked



Handle Bar Grips

ATV City Part No.	Description
392.0020	ATV Grips FA Style



Grip Lock (Glue)

ATV City Part No.	Description
392.0050	The quick, hassle free way of securing your handle bar grips



ACCESSORIES



Miscellaneous

Filters

Seat Covers

Tools

Tyres

Engine Parts

Sprayers

Tail light assemblies

	ATV City Part No.	Make	Model
	185-0100	Suzuki	LTF/LTA 400 Eiger 400 02-05 LT-A 500F Vinson 500 4WD 02-05 LT-F 250 Ozark 02-04 LT-F 500F Vinson 500 03-05 LT-Z 400 Quad Sport 03 OEM Part No. 35710-03G20
	185-0200	Honda	TRX 200 SX FourTrax 87-88 TRX 250 Recon 97-01 TRX 300 FourTrax 88-00 TRX 400 FW Foreman 95-01 TRX 450 S/ES/FE/FM 98-03 OEM Part No. 33710-HB3-771
	185-0300	Arctic Cat	All models except 50/90 cc up to 2005 OEM Part No. 0409-007
		Bombardier	All Traxter Models (XL/XT/XAM) 99-05 DS 650 00-05 Outlander 330 04 Outlander 400 03-04 Outlander 500 07 Qest 500 02-04 Quest 650/XT 02-04 Rally 03-04 OEM Part No. 710 000 055
		Polaris	All Scrambler Models 400/500 95-06 Sport 400L 96-99 Trail Blazer 250 96-06 Trail Blazer 400 03 OEM Part No. 403 2085
	185.0500	Honda	TRX420 09-13 TRX500 12-13 OEM REF#33700-HP5-A50
	185.0600	Honda	TRX250 05-14 TRX420 2014 TRX500FM 07-11 TRX500FM 2014 TRX500FA 11-13 OEM REF#33700-HN1-A71
	185-0005	Yamaha	YFA1 Brezze 89-98 YFB 250 Timberwolf 2WD/4WD 92-96 YFB 250U 98 YFM 250 Moto-4 90-01 YFM 350 ER 91-94 YFM 350 FW Big Bear 4WD 90-98 YFM 350 FX Wolverine 95-98 YFM 350 X Warrior 89-98 YFM 400 FW Kodiak 93-98 YFM 600 FWA 98 YFS 200 Blaster 90-97 YFU 1 Pro Hauler 89 YFZ 350 Banshee 94-98 OEM Part No. 1K8-84521-00
	185.0400	Arctic Cat	400-1000cc models 06-09 OEM Part No. 0509-025

WORKSHOP MANUALS



Honda

ATV City Part No.	Description
270.M446	Honda TRX250 Recon 1997-2007
270.M346	Honda TRX300 1988-2000
270.M200	Honda TRX350 Rancher / Fourtrax 2000-2006
270.M205	Honda TRX450ES/S/FM/FE 1998-2004
270.M210	Honda TRX500FA Rubicon 2001-2004
270.M206	Honda TRX500FM 2005-2011

Kawasaki

ATV City Part No.	Description
270.M465	Kawasaki KLF220/250 1988-2003
270.M466	Kawasaki KLF300 1986-2004
270.M467	Kawasaki KLF400 1993-1999

Polaris

ATV City Part No.	Description
270.M362	Polaris Magnum 425 / Big Boss 500 1996-1999
270.M365	Polaris Sportsman 400/450 & 500 / Explorer 1996-2008
270.M366	Polaris Sportsman 600 / 700 / 800 2002-2010

Suzuki

ATV City Part No.	Description
270.M483	Suzuki LT-4WD 87-98 Quad Runner
270.M483	Suzuki LT-4WDX 91-98 King Quad
270.M483	Suzuki LT-F250 Quad Runner 88-98

Yamaha

ATV City Part No.	Description
270.M499	Yamaha YFM80 Moto-4 85-88
270.M499	Yamaha YFM80 Badger 92-01
270.M499	Yamaha YFM80 Raptor 02-08
270.M489	Yamaha YFM250 89-91
270.M489	Yamaha YFB250 92-94
270.M490	Yamaha YFM350FW Big Bear 87-99
270.M490	Yamaha YFM400FW Kodiak 00-04
270.M285	Yamaha YFM660 Grizzly 02-07

ACCESSORIES

Miscellaneous

Filters

Seat Covers

Tools

Tyres

Engine Parts

Sprayers



Service Stickers

ATV City Part No.	Description
120.0360	Waterproof, 57mm x 25mm, 1 roll = 250 stickers



Pull Start Handles/Rope

ATV City Part No.	Description
120.0380	Pull Start Handle
120.0390	Pull Start Rope - packet of 5 strips @ 5mm x 1.75m)

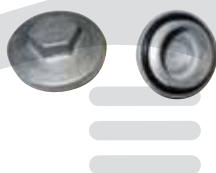

Diff Filler Cap

ATV City Part No.	Description
100.0080	Filler Cap for all Honda Differentials



Universal Carrier Mount

ATV City Part No.	Description
120.0500	Uni carrier mount - A Very useful bracket for mounting anything off your carrier without having to drill holes in it, i.e. signs, flags etc



Helmets

ATV City Part No.	Description
380.0005	Helmet Nitro X512V Black - Extra Small
380.0010	Helmet Nitro X512V Black - Small
380.0015	Helmet Nitro X512V Black - Medium
380.0020	Helmet Nitro X512V Black - Large
380.0025	Helmet Nitro X512V Black - Extra Large
380.0030	Helmet Nitro X512V Black - XX Large



KFI WINCHES



ST17 Winch

This Compact 1700lb Sport Trial Series winch features water Resistant seal to keep the elements out, a standard 4-hole Mounting design and a heavy duty 3-stage planetary gear system with all metal enclosures

- Rated Line Pull : 1700 lbs
- Motor : 12 DC, 0.58 hp permanent magnet
- Gear Ratio: 103:1
- Cable: 5/32" D x 49' L
- Winch Dimensions: 10.56" L x 3.85" D x 4.7" H
- Mounting bolt Pattern : 3.00" x 4.875" (4-Hole)
- Winch Weight: 17.6 lbs

ATV City Part Number # 375.ST1700

A2500 Winch

This 2500lb ATV Series winch features Water Resistant seals to keep the elements out, a standard 4-hole mounting design and a heavy duty all metal turn clutch.

- Rated Line Pull: 2500 lbs
- Motor: 12Vdc, 1.2hp permanent Magnet.
- Gear Ratio: 171:1
- Cable: 3/16" D x 45.9' L
- Winch Dimensions: 12.67" L x 4.06" D x 4.2" H.
- Mounting Bolt Pattern: 3.00" x 4.875" (4-Hole)
- Winch Weight: 24.8 lbs

ATV City Part Number # 375.A2500



A3000 Winch

This 3000lb ATV Series winch features Water Resistant seals to keep the elements out, a standard 4-hole mounting design and a heavy duty all metal turn clutch.

- Rated Line Pull: 3000 lbs
- Motor: 12Vdc, 1.5hp permanent Magnet.
- Gear Ratio: 171:1
- Cable: 3/16" D x 45.9' L
- Winch Dimensions: 12.67" L x 4.06" D x 4.2" H.
- Mounting Bolt Pattern: 3.00" x 4.875" (4-Hole)
- Winch Weight: 24.8 lbs
- Hand-held remote included

ATV City Part Number # 375.A3000



U4500 Winch

This 4500lb UTV Series winch features Water Resistant seals to keep the elements out, a standard 4-hole mounting design and a heavy duty all metal turn clutch.

- Rated Line Pull: 4500 lbs
- Motor: 12Vdc, 1.7hp permanent Magnet.
- Gear Ratio: 166:1
- Cable: 15/64" D x 38' L
- Winch Dimensions: 14.6" L x 4.55" D x 4.82" H.
- Mounting Bolt Pattern: 3.00" x 4.875" (4-Hole)
- Winch Weight: 35.5 lbs
- Hand-held remote included

ATV City Part Number # 375.U4500

KFI STEALTH WINCHES



SE25 Stealth Winch

This 2500 lb ATV Stealth Series winch features Synthetic Cable, Cable Hook Stopper, a dynamic and mechanical braking system, Water Resistant seals to keep the elements out, a standard 4-hole mounting design and a heavy duty all metal turn clutch.

- Rated Line Pull: 2500 lbs
- Motor: 12Vdc, 1.2 hp permanent Magnet.
- Gear Ratio: 171:1
- Cable: 3/16" D x 50' L
- Winch Dimensions: 12.67" L x 4.06" D x 4.2" H.
- Mounting Bolt Pattern: 3.00" x 4.875" (4-Hole)
- Winch Weight: 22.7 lbs
- Cable Hook Stopper Included

ATV City Part Number # 375.SE2500



SE35 Stealth Winch

This 3500 lb ATV Stealth Series winch features Synthetic Cable, Cable Hook Stopper, a dynamic and mechanical braking system, Water Resistant seals to keep the elements out, a standard 4-hole mounting design and a heavy duty all metal turn clutch.

- Rated Line Pull: 3500 lbs
- Motor: 12Vdc, 1.5 hp permanent Magnet.
- Gear Ratio: 171:1
- Cable: 3/16" D x 50' L
- Winch Dimensions: 12.97" L x 4.06" D x 4.2" H.
- Mounting Bolt Pattern: 3.00" x 4.875" (4-Hole)
- Winch Weight: 24.5 lbs
- Cable Hook Stopper Included
- Hand-held remote included

ATV City Part Number # 375.SE3500



SE45 Stealth Winch

This 4500 lb UTV Stealth Series winch features Synthetic Cable, Cable Hook Stopper, a dynamic and mechanical braking system, Water Resistant seals to keep the elements out, a standard 4-hole mounting design and a heavy duty all metal turn clutch.

- Rated Line Pull: 4500 lbs
- Motor: 12Vdc, 1.7 hp permanent Magnet.
- Gear Ratio: 166:1
- Cable: 15/64" D x 38' L
- Winch Dimensions: 14.6" L x 4.55" D x 4.82" H.
- Mounting Bolt Pattern: 3.00" x 4.875" (4-Hole)
- Winch Weight: 32 lbs
- Cable Hook Stopper Included
- Hand-held remote included

ATV City Part Number # 375.SE4500



ACCESSORIES



Winch Mounting Kits

ATV City Part No.	Make	Description
375.100525	Can Am	Outlander 400 / 500 / 800 02-14
375.100725	Can Am	Renegade 500 08-12 / 800 07-11
375.100705	Honda	TRX420 07-13 (use only 2000lb winch)
375.101175	Honda	TRX420 All types 2014
375.101175	Honda	TRX500FE/FM/FP 2014
375.100885	Honda	TRX500FE/FM/FPM 2012-13
375.100585	Honda	TRX500FE/FM 07-11
375.100585	Honda	TRX500FA/FPA 07-14
375.100540	Honda	TRX650/680 03-14
375.100940	John Deere	Gator XUV550 12-13
375.100860	John Deere	Gator XUV625i / 825i / 855D 11-13
375.100535	Kawasaki	KVF650 / 750 05-14
375.100575	Kawasaki	Mule 600 / 610 05-14
375.100845	Kawasaki	Mule 4000 / 4010 Series 09-14
375.100820	Kubota	RTV900 / 1140 09-12
375.100471	Kubota	RTV900 04-08
375.100740	Polaris	Sportsman 550 / 850 09-14
375.100820	Polaris	Ranger 400 / EV 10-14
375.100760	Polaris	Ranger Diesel HD / Crew / 6x6
375.100680	Suzuki	LTA / LTF 400 King Quad 08-14
375.100450	Suzuki	LTA450 / 500 / 700 / 750 King Quad 05-14
375.100530	Yamaha	YFM350 / 400 / 450 Grizzly 07-14
375.100610	Yamaha	YFM550 / 700 Grizzly 07-14

ACCESSORIES



Winch Spare Parts

ATV City Part No.	Description
375.20005	Replacement Winch Contactor Block Works with all KFI winches and can also work with other branded winches
375.20010	Winch Motor End Cap – A-Series Winchs
375.20020	Winch Cable – Synthetic 3/16" x 50' (Suits up to 3500lbs) High strength 12-strand Dyneema Synthetic fiber rope has a higher breaking strength than that of steel cable and it is lighter. It won't bind up or develop those sharp frays that give nasty splinters We recommend that when replacing the cable you also purchase the Aluminium Hawse ...
375.ATVHWSW	Aluminium Hawse Designed to work with synthetic cables Eliminates cable pinch caused by roller fairleads and synthetic cable.
375.ATVMR	KFI Winch Mini Rocker Handle Bar Switch Take Control of your winch with the Mini-Rocker switch that comes with an adjustable bracket to mount it to your ATV's handlebars and allows you to control your winch with the touch of your finger without ever letting go of your handlebars.
375.ATVWRC	KFI Wireless Remote Control <ul style="list-style-type: none"> • Wireless remote holder can be mounted to your dash or handle bars. • Up tp 75' distance. • For adding a wireless remote to any existing winch with a standard ATV contactor.



ACCESSORIES



Tool Boxes

ATV City Part No.	Description
110.0020	Tool Box Agri -Red/Black (Front Mountable) Comes complete with mounting kit and 2 pull out trays Dimensions 750mm x 310mm x 210mm
110.0025	Tool Box Agri -Grey/Black (Front Mountable) Comes complete with mounting kit and 2 pull out trays Dimensions 750mm x 310mm x 210mm
110.0030	Agri Box Bungee Mounting Kit - So that the Agri Box can be taken on and off the ATV quickly using Bungee Cords



Cargo Net

ATV City Part No.	Description
120.0150	Cargo net 15" x 30" with hooks

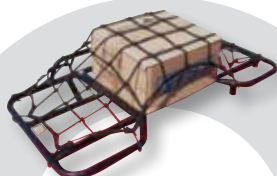

Reflectors

ATV City Part No.	Description
120.0245	Reflector Round 6mm bolt on - Red
120.0248	Reflector Round 6mm bolt on - Amber



Spot Light

ATV City Part No.	Description
120.0750	12v 55w Handle Bar or Carrier Mountable Spot Light, Turns, Swivels with Detachable Head. Great for lambing or lamping.



Miscellaneous

Filters

Seat Covers

Tools

Tyres

Engine Parts

Sprayers

ACCESSORIES



Miscellaneous

Filters

Seat Covers

Tools

Tyres

Engine Parts

Sprayers

UTV Accessories



ATV City Part No.

Description

265.18003
265.75003

UTV Double Gun Carrier – Black
UTV Double Gun Carrier – Camo

- Heavy Duty ProtekX Extreme fabric
- One rifle or shotgun fits in each side
- Three large gear pockets for extra shells or other items
- Attaches securely to the back of UTV roll cages with heavy duty straps and quick release buckles
- Bottom D-rings provide additional lash points
- Durable weather resistant zippers
- Extra-Thick padding keeps rifles protected
- 53" L x 4" W x 17" H

265.18023
265.18030

UTV Cab Enclosure – Polaris Ranger XP/HD 2009-
UTV Cab Enclosure – Kawasaki Mule 4010

- Heavy Duty ProtekX Extreme fabric
- Fits over the roll cage to protect against rain, snow, sun and wind
- Keeps the cab clean and dry in storage
- Large ultra-clear windscreen material, doors and back window for excellent visibility
- Doors can be rolled back or completely removed for easy cab access and ventilation in warmer weather
- Mounts to the roll cage with buckles, rip-and-grip closure tabs and self-adhesive tape

265.18025
265.18032

UTV Roll Cage Top – Polaris Ranger XP/HD
UTV Roll Cage Top – Kawasaki Mule 4010

- Heavy Duty ProtekX Extreme fabric
- Overhead protection against the elements
- Attaches to the roll bar with four clinch-tight straps, rip-and-grip strips and two tension panel straps

ACCESSORIES



UTV Accessories



ATV City Part No.	Description
265.18026 265.18033 265.73087	UTV Seat Cover – Polaris Ranger XP/HD – 2009- Black UTV Seat Cover – Kawasaki Mule 4010 UTV Seat Cover – Kawasaki Mule 610 <ul style="list-style-type: none"> • Heavy Duty ProtekX Extreme fabric • Protects new seats and renews the look of old seats • Shields against dirt, mud and weather damage • Hose clean or machine wash • Elasticized hem and attachment straps provide a quick and custom fit.
265.18028 265.18035	UTV Windscreen – Polaris XP/HD UTV Windscreen – Kawasaki Mule 4010 <ul style="list-style-type: none"> • Ultra-clear window material framed with heavy-duty ProtekX Extreme fabric • Rolls up for easy storage • Attaches in seconds
265.73443 265.73447	UTV Roll Cage Organizer – Camo UTV Roll Cage Organizer – Black <ul style="list-style-type: none"> • Heavy Duty ProtekX Extreme fabric • The ultimate in organizing – Features a non-scratch padded binocular or camera pouch, four zippered gear pockets and two fast-access end pockets for radios or cell phones. • Quickly attached to the front or rear of UTV roll cages with rip-and-grip panels and adjustable straps • Protective foam base
265.77777	UTV Hand Holds <ul style="list-style-type: none"> • Heavy Duty ProtekX Extreme fabric • Adjustable straps fit most UTV roll cages • Textured grip handles • Two hand holds included in each package
265.0100	UTV Tailgate Cable 330mm PVC Coated



the best part of your atv

- 1: BEARINGS, BUSH KITS, BALLJOINTS
- 2: BRAKING
- 3: BULLBARS, MUDFLAP KITS
- 4: CABLES
- 5: CARBURETTOR PARTS
- 6: DRIVE LINE / CVT BELTS / AXLES
- 7: ELECTRICAL
- 8: EXHAUSTS
- 9: MISCELLANEOUS
- 10: FILTERS
- 11: SEAT COVERS, OVER COVERS
- 12: TOOLS
- 13: TYRES / TUBES / RIMS
- 14: ENGINE COMPONENTS
- 15: SPRAYERS & SPRAYER ACCESSORIES



10: OIL, FUEL & AIR FILTERS

OIL FILTERS



Arctic Cat

ATV City Part No.	Model	Year	OEM Ref
170.0035	250 Arctic Cat	99-05	3436-005
170.0035	300 Arctic Cat	98-05	3436-005
170.0040	400 Arctic Cat	98-03	0436-146 / 0812-005
170.0040	400 2x4 Automatic	03-04	0436-146 / 0812-005
170.0040	400 4x4 Automatic / LE / TBX	03-06	0436-146 / 0812-005
170.0040	400 4x4 ACT	2004	0436-146 / 0812-005
170.0040	400 4x4 ACT Auto	2004	0436-146 / 0812-005
170.0040	400 4x4 VP	05-06	0436-146 / 0812-005
170.0040	454 Arctic Cat	96-98	0436-146 / 0812-005
170.0040	500 Arctic Cat	98-04	0436-146 / 0812-005
170.0040	500 4x4	04-08	0436-146 / 0812-005
170.0040	500 4x4 Auto / LE / TBX	04-07	0436-146 / 0812-005
170.0110	700 Diesel	All	3206-194

Bombardier / Can-Am

ATV City Part No.	Model	Year	OEM Ref
170.0060	330 Outlander	04-06	420256188 / 711256188
170.0060	400 Outlander	04-13	420256188 / 711256188
170.0060	500 Outlander	07-13	420256188 / 711256188
170.0060	500 Renegade	08-13	420256188 / 711256188
170.0060	DS650	01-06	420256188 / 711256188
170.0060	650 Outlander	07-13	420256188 / 711256188
170.0060	800 Outlander	06-13	420256188 / 711256188
170.0060	800 Renegade	08-13	420256188 / 711256188
170.0060	800 SSV R Commander	11-13	420256188 / 711256188
170.0060	1000 Outlander	12-13	420256188 / 711256188
170.0060	1000 SSV Commander	11-13	420256188 / 711256188

Honda

ATV City Part No.	Model	Year	OEM Ref
170.0015	ATC250 ES Big Red	85-87	15412-KF0-000 / 15412-HM5-A10
170.0015	TRX250	85-87	15412-KF0-000 / 15412-HM5-A10
170.0015	TRX250 X Fourtax	86-92	15412-KF0-000 / 15412-HM5-A10
170.0015	TRX300 Big Red	88-00	15412-KF0-000 / 15412-HM5-A10

OIL FILTERS



Honda

ATV City Part No.	Model	Year	OEM Ref
170.0015	TRX300EX Sportrax	03-89	15412-KF0-000 / 15412-HM5-A10
170.0015	TRX350D	86-89	15412-KF0-000 / 15412-HM5-A10
170.0015	TRX350 TE/FM Rancher	00-06	15412-KF0-000 / 15412-HM5-A10
170.0015	TRX400 FW Foreman	95-02	15412-KF0-000 / 15412-HM5-A10
170.0015	TRX400 EX Sportrax	99-08	15412-KF0-000 / 15412-HM5-A10
170.0010	TRX400 FA Rancher AT	04-07	15412-413-000 / 15412-KEA-003
170.0015	TRX420 FE/FM Rancher	07-14	15412-KF0-000 / 15412-HM5-A10
170.0015	TRX450S/ES/FE/FM Foreman	98-02	15412-KF0-000 / 15412-HM5-A10
170.0010	TRX500 FA Foreman Rubicon	00-12	15412-413-000 / 15412-KEA-003
170.0015	TRX500 FE/FM Foreman	05-14	15412-KF0-000 / 15412-HM5-A10
170.0010	TRX650 FA Rincon	03-05	15412-413-000 / 15412-KEA-003

Kawasaki

ATV City Part No.	Model	Year	OEM Ref
170.0030	KLF220 Bayou	88-02	16099-004
170.0030	KLF250 Bayou	03-11	16099-004
170.0030	KSF250 Mojave	87-04	16099-004
170.0105	KAF300 Mule 500 / 520 / 550		49065-2071 / 49065-2078
170.0030	KEF300 Lakota	95-03	16099-004
170.0030	KLF300 B / C Bayou	86-04	16099-004
170.0020	KVF300 A Prairie	99-02	16097-1064 / 16097-0004
170.0055	KVF360 Prairie	03-13	16097-0002 / 16097-1072
170.0105	KAF400 Mule	05-13	49065-2071 / 49065-2078
170.0020	KLF400 Bayou	93-98	16097-1064 / 16097-0004
170.0020	KVF400 Prairie	97-02	16097-1064 / 16097-0004
170.0020	KAF450 Mule 1000		16097-1064 / 16097-0004
170.0020	KAF540 Mule 2010/2020/2030		16097-1064 / 16097-0004
170.0105	KAF620 Mule 2500/3010/4010		49065-2071 / 49065-2078
170.0055	KVF650 Prairie / Brute Force	02-13	16097-0002 / 16097-1072
170.0055	KFX700 (KSV700) V-Force	04-09	16097-0002 / 16097-1072
170.0055	KVF700 Prairie	04-06	16097-0002 / 16097-1072
170.0055	KVF750 Brute Force	05-13	16097-0002 / 16097-1072
170.0055	KRF750 Teryx	08-13	16097-0002 / 16097-1072
170.0120	KAF950 Mule 2510/3010/4010 Diesel	03-13	16097-1069

Kubota

ATV City Part No.	Model	Year	OEM Ref
170.0140	RTV900 Diesel		HH15032430
170.0145	RTV900 Diesel - Transmission		HHK7114080



OIL FILTERS



Polaris

ATV City Part No.	Model	Year	OEM Ref
170.0020	300 Hawkeye	07-11	3084963
170.0020	300 Sportsman	08-10	3084963
170.0020	325 Magnum	00-02	3084963
170.0020	325 Trial Boss	00-02	3084963
170.0020	325 Xpedition	00-02	3084963
170.0020	330 ATP	04-05	3084963
170.0020	330 Hawkeye	2006	3084963
170.0020	330 Magnum	03-06	3084963
170.0020	330 Trial Blazer	08-11	3084963
170.0020	330 Trial Boss	03-11	3084963
170.0020	335 Sportsman	99-01	3084963
170.0020	335 Worker	1999	3084963
170.0020	400 Hawkeye HO	2011	3084963
170.0020	400 Sportsman	04-05	3084963
170.0020	400 Sportsman HO	08-11	3084963
170.0020	400 L Xplorer	96-01	3084963
170.0020	400 Ranger	10-13	3084963
170.0020	425 Magnum 4x4 / 6x6	95-98	3084963
170.0020	425 Xpedition	00-02	3084963
170.0020	425 Ranger	01-03	3084963
170.0020	450 Sportsman	06-07	3084963
170.0020	500 ATP HO	04-05	3084963
170.0020	500 Big Boss 6x6	98-99	3084963
170.0020	500 Magnum	00-02	3084963
170.0020	500 Scrambler	96-11	3084963
170.0020	500 Sportsman HO	00-11	3084963
170.0020	500 Sportsman EFI	06-10	3084963
170.0020	500 Sportsman 6x6	00-08	3084963
170.0020	500 Sportsman X2	06-09	3084963
170.0020	500 Worker	99-01	3084963
170.0020	500 Xplorer	1997	3084963
170.0020	500 Ranger 2x4 / 4x4 /	06-13	3084963
170.0020	500 Ranger Crew	11-13	3084963
170.0130	570 Ranger RZR	12-13	2540086 / 2540122
170.0130	600 Sportsman Twin	05-06	2540086 / 2540122
170.0130	700 Sportsman Twin	04-06	2540086 / 2540122
170.0130	700 Sportsman Twin	05-07	2540086 / 2540122
170.0130	700 Sportsman X2 EFI	2008	2540086 / 2540122
170.0130	700 Ranger 6x6 EFI	07-09	2540086 / 2540122

OIL FILTERS



Polaris

ATV City Part No.	Model	Year	OEM Ref
170.0130	700 Ranger XP / HD /	08-09	2540086 / 2540122
170.0130	800 Sportsman Twin	2005	2540086 / 2540122
170.0130	800 Sportsman EFI	06-12	2540086 / 2540122
170.0130	800 Sportsman X2 EFI	07-09	2540086 / 2540122
170.0130	800 Sportsman HO EFI	08-09	2540086 / 2540122
170.0130	800 Sportsman Big Boss	11-12	2540086 / 2540122
170.0130	800 Sportsman Touring	08-09	2540086 / 2540122
170.0130	800 Ranger 4x4 / 6x6 /	10-13	2540086 / 2540122
170.0130	800 Ranger Crew	11-13	2540086 / 2540122
170.0130	800 Ranger HD	11-12	2540086 / 2540122
170.0130	800 Ranger RZR / LE /	08-13	2540086 / 2540122
170.0130	800 Ranger XP	11-12	2540086 / 2540122
170.0130	900 Ranger XP / LE	2013	2540086 / 2540122
170.0130	900 Ranger RZR XP EFI	2013	2540086 / 2540122
170.0125	900 Ranger Diesel	2011	3070131

Suzuki

ATV City Part No.	Model	Year	OEM Ref
170.0035	LT-F160		16510-24501 / 16510-19B00
170.0035	LT230	85-93	16510-24501 / 16510-19B00
170.0035	LT250	85-86	16510-24501 / 16510-19B00
170.0035	LT-F250 Quad Runner	88-02	16510-24501 / 16510-19B00
170.0035	LT-F250 Ozark	03-12	16510-24501 / 16510-19B00
170.0035	LT-Z250 QuadSport	04-09	16510-24501 / 16510-19B00
170.0035	LT 4WD (300)	87-99	16510-24501 / 16510-19B00
170.0035	LT-F300 King Quad	91-02	16510-24501 / 16510-19B00
170.0040	LTF / LTA400 Eiger	02-07	16510-34E00 / 16510-07J00
170.0040	LTF / LTA400 King Quad	08-13	16510-34E00 / 16510-07J00
170.0040	LT-A450 X King Quad	07-10	16510-34E00 / 16510-07J00
170.0040	LT-F500 F Quadrunner	98-02	16510-34E00 / 16510-07J00
170.0040	LT-A500 F Quadrunner	98-02	16510-34E00 / 16510-07J00
170.0040	LT-A500 X / AXI King	09-12	16510-34E00 / 16510-07J00
170.0040	LT-F500 F Vinson	02-07	16510-34E00 / 16510-07J00
170.0040	LT-A700 X King Quad	05-08	16510-34E00 / 16510-07J00
170.0040	LT-A750 X King Quad	08-12	16510-34E00 / 16510-07J00



OIL FILTERS



Yamaha

ATV City Part No.	Model	Year	OEM Ref
170.0050	YFM200 N , DXS , DXW	85-89	5H0-13440-09 / 3UH-E3440-00
170.0050	YFM225	86-90	5H0-13440-09 / 3UH-E3440-00
170.0050	YFM230 Bear Tracker	03-04	5H0-13440-09 / 3UH-E3440-00
170.0050	YFB250 Timberwolf	92-00	5H0-13440-09 / 3UH-E3440-00
170.0050	YFM250 Moto-4	89-93	5H0-13440-09 / 3UH-E3440-00
170.0050	YFM250 Bear Tracker	91-04	5H0-13440-09 / 3UH-E3440-00
170.0050	YFM250 Bruin	2006	5H0-13440-09 / 3UH-E3440-00
170.0050	YFM250 Big Bear	07-09	5H0-13440-09 / 3UH-E3440-00
170.0045	YFM350 XT , XU Warrior	87-88	IUY-13440-01 / 02
170.0045	YFM350 ERT- ERU	87-88	IUY-13440-01 / 02
170.0045	YFM350 FW Big Bear	87-99	IUY-13440-01 / 02
170.0020	YFM350 BA / FA Bruin	04-06	5GH-13440-00 / 3FV-13440-00
170.0045	YFM350 Wolverine	96-05	IUY-13440-01 / 02
170.0055	YFM350 Wolverine	06-09	5GH-13440-20
170.0045	YFM350 Warrior	89-04	IUY-13440-01 / 02
170.0055	YFM350 Wolverine	07-08	5GH-13440-20
170.0045	YFM350 Raptor	05-13	IUY-13440-01 / 02
170.0055	YFM350 Grizzly	07-13	5GH-13440-20
170.0055	YFM350 Grizzly IRS	07-13	5GH-13440-20
170.0045	YFM400 FW Kodiak	94-99	IUY-13440-01 / 02
170.0020	YFM400 FA Kodiak	00-06	5GH-13440-00 / 3FV-13440-00
170.0045	YFM400 Big Bear	93-06	IUY-13440-01 / 02
170.0055	YFM400 Grizzly	2007	5GH-13440-20
170.0045	YFM400 FB Big Bear IRS	07-12	IUY-13440-01 / 02
170.0020	YFM450 FA Kodiak	03-06	5GH-13440-00 / 3FV-13440-00
170.0020	YFM450 Wolverine	2006	5GH-13440-00 / 3FV-13440-00
170.0055	YFM450 FX Wolverine	07-10	5GH-13440-20
170.0055	YFM450 FG Grizzly	07-13	5GH-13440-20
170.0020	YXR450 Rhino	06-09	5GH-13440-00 / 3FV-13440-00
170.0055	YFM550 FG Grizzly	09-12	5GH-13440-20
170.0020	YFM660 Grizzly	02-06	5GH-13440-00 / 3FV-13440-00
170.0055	YFM660 Grizzly	07-08	5GH-13440-20
170.0020	YXR660 Rhino	04-06	5GH-13440-00 / 3FV-13440-00
170.0055	YFM700 FG Grizzly	07-13	5GH-13440-20
170.0055	YXR700 Rhino	08-13	5GH-13440-20

FUEL FILTERS



Fuel Filters



ATV City Part No.	Description
120.0180	1/4" Inline fuel filter 2" long. Helps to prevent debris and foreign particles getting into your carburettor.
170.5060	In-Line Fuel Filter to suit Kubota RTV900 OEM 1258143013
170.5050	TRX420 T-Bag Fuel Filter OEM REF: 16706-HN8-A62
170.6200	Polaris T-Bag Fuel Filter to suit P/n 170.6100

Diesel fuel filter

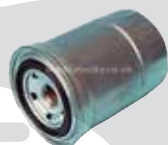

ATV City Part No.	Description
170.5000	Kawasaki Mule OEM 51056-1051
170.5010	Arctic Cat 700 Diesel OEM 3206-012

Fuel Pump



ATV City Part No.	Description
170.6100	Fuel Pump Replacement to suit Suzuki LTA 450/500/700/750 Polaris ATV's 500/700/800 2008-2014 Polaris Ranger 800 2011-2012

AIR FILTERS



Arctic Cat

ATV City Part No.	Model	OEM Part ref.
135.AT08000	700 Diesel - (External)	0470-619
135.AT08100	700 Diesel - (Internal)	0470-620



AIR FILTERS

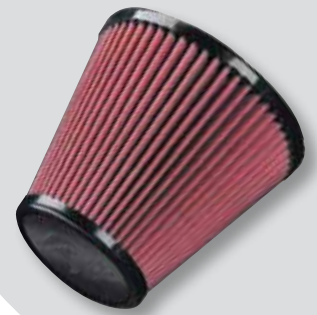

Can-Am

ATV City Part No.	Model	OEM Part ref.
135.AT07284	330 Outlander 2004-05	707800120
135.AT07284	400 Outlander 2003-08	707800120
135.AT07283	500 Outlander 2007-10	707800174
135.AT07283	500 Renegade 2008-10	707800174
135.AT07283	650 Outlander 2006-10	707800174
135.AT07283	650 DS 2000-07	707800174
135.AT07283	800 Outlander 2006-09	707800174
135.AT07283	800 Renegade 2007-09	707800174



Honda

ATV City Part No.	Model	OEM Part ref.
135.AT07074	TRX250 RECON/EX	17254-HM8-000
135.AT07026	TRX300 92 - 00	17254-HC5-900
135.AT07252	TRX350FOURTRAX/RANCHER 00-06	17254 HM5-670
135.AT07026	TRX400FW 96-100	17254-HC5-900
135.AT07089	TRX420 07-09	17254-HC5-600
135.AT07026	TRX450S/FM 98 - 05	17254-HC5-900
135.AT07077	TRX500FM/FE 06-11	17254-HP0-A00



Kawasaki

ATV City Part No.	Model	OEM Part ref.
135.AT07257	KLF220 99-02	11013 - 1275
135.AT07257	KLF250 03-07	11013- 1275
135.AT07009	KLF300 B/C 88 - 09	11013 - 1205/1255/1275
135.AT07009	KVF300 PRAIRIE 97 - 04	11013 - 1205/1255/1275
135.AT07009	KLF400 B 93-99	11013-1205/1255/1275
135.AT07009	KAF620 MULE 2500/10/20 94 - 00	11013-1205/1255/1275
135.AT07262	KVF650 Brute Force 4x4 2005-10	11013-0001
135.AT07262	KVF650 Brute Force 4x4I 2006-09	11013-0007 / 11013-0021
135.AT07262	KVF650/700 Prairie 4x4 2003-06	11013-0001
135.AT07262	KSV700 KFX 2004-09	11013-0001
135.AT07280	MULE DIESEL 2510/3010/3020 00-08	11013-1290



Kubota

ATV City Part No.	Model	OEM Part ref.
135.AT08200	RTV900 DIESEL	K121182320

Miscellaneous

Filters

Seat Covers

Tools

Tyres

Engine Parts

Sprayers

AIR FILTERS



Polaris

ATV City Part No.	Model	OEM Part ref.
135.AT07264	200 Phoenix 05-08	1253355
135.AT07264	200 Sawtooth 06-07	1253355
135.AT07264	P250 Trail Blazer 2 x 4 01-06	1253355
135.AT07264	P250 Xplorer 2 x 4 2001	1253355
135.AT07264	P300 Hawkeye	1253355
135.AT07264	300 Sportsman 2008	1253355
135.AT07264	P400L Xplorer 4 x 4	1253355
135.AT07265	P325 Magnum 2002	1253372
135.AT07265	P325 Trial Boss 2001-06	1253372
135.AT07043	325 TRIAL BOSS 00 - 01	7080595/1253114
135.AT07043	325 EXPEDITION 00-01	7080595/1253114
135.AT07265	P330 Trial Boss 2003-08	1253372
135.AT07265	P330 ATP 2004-05	1253372
135.AT07265	P330 Magnum 2003-06	1253372
135.AT07043	335 SPORTSMAN 99 - 01	7080595/1253114
135.AT07293	Ranger 400 4x4 2010	7081308
135.AT07007	400 SCRAMBLER 2X4/4X4 95-01	1253118
135.AT07007	400 SPORT 96 - 99	1253118
135.AT07007	400 TRAIL BLAZER 2003	1253118
135.AT07007	400 X PLOER 4X4 99 - 00	1253118
135.AT07007	400XPRESS 2 X 4 96-97	1253118
135.AT07043	400 SPORTSMAN 01-05	7080595/1253114
135.AT07007	425 MAGNUM 2 X 4 / 4X4 6X6 95-98	1253118
135.AT07043	425 XPEDITION 4X4 2000	7080595/1253114
135.AT07043	450 SPORTSMAN 06 - 07	7080595/1253114
135.AT07043	455 DIESEL 99-01	7080595/1253114
135.AT07043	500 SPORTSMAN 4X4/6X6 06-07	7080595/1253114
135.AT07043	500 ATP 4X4 04-05	7080595/1253114
135.AT07043	500 XPLORER 4X4 97	7080595/1253114
135.AT07007	500 BIG BOSS 6X6 98 - 99	1253118
135.AT07043	500 MAGNUM 99 - 02	7080595/1253114
135.AT07043	500 SCRAMBLER 01-02	7080595/1253114
135.AT07293	Ranger 500 2x4/4x4/EFI 2006-10	7081308
135.AT07293	Ranger 500 2x4 Carb 2008-09	7081308
135.AT07043	600 SPORTSMAN 4X4 03-05	7080595/1253114
135.AT07043	700 SPORTSMAN 4X4/EFI 02-07	7080595/1253114
135.AT07293	MVRS 700/800 4x4 2008	7081308
135.AT07293	Ranger 700 4x4 EFI/XP All Options 2006-	7081308
135.AT07293	Ranger 700 6x6 EFI 2006-09	7081308
135.AT07043	800 SPORTSMAN / EFI 05-07	7080595/1253114
135.AT07293	Ranger 800 4x4 / 6x6 EFI All Options	7081308
135.AT07043	SPORTSMAN MILITARY 2005	7080595/1253114



AIR FILTERS



Suzuki

ATV City Part No.	Model	OEM Part ref.
135.AT07267	LT80 87-06	13780 - 40B00
135.AT07041	LTF250 88-01	13781 - 19B00
135.AT07269	LTF250 OZARK 02 -09	13780-05G10
135.AT07041	LTF300 KING QUAD 87-02	13781-19B00
135.AT07270	LTF/LTA400 EIGER 02-07	13780-03G00
135.AT07270	LTZ400 QUAD SPORT 03-07	13780 - 03G00
135.AT07270	LTA500 VINSON 4X4 02-07	13780-03G00
135.AT07262	LTV700 Twin Peaks 2004-05	11013-0001
135.AT07272	LTA700X KING QUAD 05-07	13780-31G00

Yamaha

ATV City Part No.	Model	OEM Part ref.
135.AT07030	YFM 250 MOTO - 4	1YW-14451-00-00
135.AT07030	YBF250 TIMBERWOLF 92-01	1YW-14451-00-00
135.AT07275	YFM250 Big Bear 2007-08	4XE-E445-00-00
135.AT07275	YFM250X Bear Tracker 1999-03	4XE-E445-00-00
135.AT07275	YFM250FAS Bruin 2005-06	4XE-E445-00-00
135.AT07030	YFM350FW Big Bear	1YW-14451-00-00
135.AT07276	YFM350FAS Bruin 2004-06	5UH-E4451-10-00
135.AT07276	YFM350 Grizzly 2007-10	5UH-E4451-10-00
135.AT07008	YFM350 Raptor 2004-09	1UY-14451-00
135.AT07008	YFM350X Warrior 1987-04	1UY-14451-00
135.AT07008	YFM350FX Wolverine 1987-05	1UY-14451-00
135.AT07276	YFM350FX Wolverine 2006-09	5UH-E4451-10-00
135.AT07276	YFM400FX Wolverine 2005-06	5UH-E4451-10-00
135.AT07030	YFM400FW Big Bear	1YW-14451-00-00
135.AT07275	YFM400N / FWNH Big Bear	4XE-E445-00-00
135.AT07276	YFM400 Kodiak 2005-06	5UH-E4451-10-00
135.AT07276	YFM400 Grizzly Auto 4x4 2007-08	5UH-E4451-10-00
135.AT07277	YXR450 Rhino 2006-09	5UG-E4451-00-00
135.AT07276	YFM450 Grizzly Auto 4x4 2005-10	5UH-E4451-10-00
135.AT07276	YFM450FX Wolverine 2007-10	5UH-E4451-10-00
135.AT07159	YFM550 Grizzly 09-13	1HP-E4451-00-00
135.AT07008	YFM600FW/A/H Grizzly 1997-01	1UY-14451-00
135.AT07008	YFM660F/H Grizzly 2002-08	1UY-14451-00
135.AT07277	YXR660 Rhino 2004-07	5UG-E4451-00-00
135.AT07159	YFM700 Grizzly 09-13	1HP-E4451-00-00



Miscellaneous

Filters

Seat Covers

Tools

Tyres

Engine Parts

Sprayers



the best part of your atv

- 1: BEARINGS, BUSH KITS, BALLJOINTS
- 2: BRAKING
- 3: BULLBARS, MUDFLAP KITS
- 4: CABLES
- 5: CARBURETTOR PARTS
- 6: DRIVE LINE / CVT BELTS / AXLES
- 7: ELECTRICAL
- 8: EXHAUSTS
- 9: MISCELLANEOUS
- 10: FILTERS
- 11: SEAT COVERS, OVER COVERS
- 12: TOOLS
- 13: TYRES / TUBES / RIMS
- 14: ENGINE COMPONENTS
- 15: SPRAYERS & SPRAYER ACCESSORIES

11: SEAT COVERS, OVER COVERS

SEAT COVERS

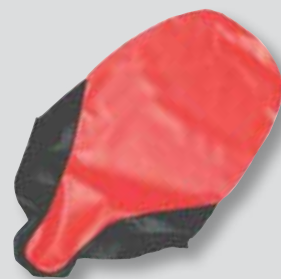

SEAT REPAIR STICKERS

Seat Repair Sticker

ATV City Part No.	Size	Description
275.0100	110mm x 170mm	Easy to repair the ripped seat, just put a repair sticker on it. Acrylic adhesive helps prevent water from sinking into the seat. *After years of use the sticker may lose adhesion.



INTERNAL SEAT HEATER

Heated Seat

ATV City Part No.	Size	Description
392.210044		Internal Seat Heater ATV/UTV and Snowmobile 20W w/Quick Disconnect Cable



VINYL, STAPLE-ON REPLACEMENT COVERS

Honda

ATV City Part No.	Description	Model
275.H0404	SEAT COVER	TRX250 98-03
275.H0536	SEAT COVER	TRX250 04-10
275.H0304	SEAT COVER	TRX300 88-00
275.H0462	SEAT COVER	TRX350 00-03
275.H0508	SEAT COVER	TRX350 04-06
277.0130	SEAT COVER	TRX350 04-06 (Taiwanese)
275.H0303	SEAT COVER	TRX400FW 96-00
275.H0549	SEAT COVER	TRX420 07-12
277.0160	SEAT COVER	TRX420 07-12 (Taiwanese)
275.H0604	SEAT COVER	TRX420 2014
275.H0308	SEAT COVER	TRX450 98-04
275.H0476	SEAT COVER	TRX500FA 01-04
275.H0526	SEAT COVER	TRX500FA/FM 05-11
275.H0590	SEAT COVER	TRX500 12
275.H0604	SEAT COVER	TRX500 2014
275.H0515	SEAT COVER	TRX650 03-04

SEAT COVERS



VINYL, STAPLE-ON
REPLACEMENT COVERS



Kawasaki

ATV City Part No.	Description	Model
275.K0106	SEAT COVER	KLF300B
275.K0197	SEAT COVER	KLF300C
275.K0117	SEAT COVER	KVF360
275.K0110	SEAT COVER	KVF650 01-03
275.K0236	SEAT COVER	KAF620/950 Mule 3010/4010
275.K0236B	BACKREST SEAT COVER	KAF620/950 Mule 3010/4010

Polaris

ATV City Part No.	Description	Model
275.PL040	SEAT COVER	325 / 500 Magnum 95-00
275.PL011	SEAT COVER	XP550 / 850 09-10
275.PL007	SEAT COVER	Sportsman 700 05-07

Suzuki

ATV City Part No.	Description	Model
275.S0351	SEAT COVER	LTF250 Ozark 02
275.S0305	SEAT COVER	LTF250/300 99-01 King Quad
275.S0348	SEAT COVER	LTF/LTA400 02-07 Eiger
275.S0414	SEAT COVER	LTF/LTA400 08-12 King Quad
275.S0406	SEAT COVER	LTA450/500 King Quad
275.S0376	SEAT COVER	LTA700/750 King Quad

SEAT COVERS

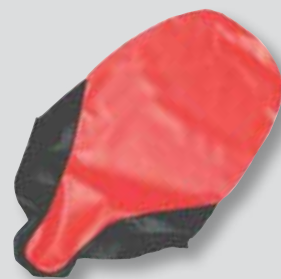

Yamaha

ATV City Part No.	Description	Model
275.Y0192	SEAT COVER	YFM250 Bear Tracker 02
275.Y0294	SEAT COVER	YFM350 AS/FAS Bruin 04
275.Y0362	SEAT COVER	YFM350 Grizzly 07-11
275.Y0044	SEAT COVER	YFM400 Kodiak 99-06 Auto
275.Y0190	SEAT COVER	YFM400 Big Bear 00-04
275.Y0198	SEAT COVER	YFM450 Kodiak 03-08
275.Y0382	SEAT COVER	YFM450 Grizzly 03-12
275.Y0360	SEAT COVER	YFM550 / 700 Grizzly 07-11
275.Y0186	SEAT COVER	YFM660 Grizzly 01-02

SEAT OVER COVERS



Universal

ATV City Part No.	Description	Model
280.78387	ProtekX	Universal (Classic Acc)

Can-Am

ATV City Part No.	Description	Model
280.B0M005C	CANVAS	Outlander / Max 500/650/800 2006-12
280.B0M008C	CANVAS	Outlander / Max 500 / 650 / 800 / 1000XT 2013

Honda

ATV City Part No.	Description	Model
280.H0405C	CANVAS	TRX250 98-03
280.H0536C	CANVAS	TRX250 04-12
280.H0305C	CANVAS	TRX300 88-00
280.H0462C	CANVAS	TRX350 00-03
280.H0508C	CANVAS	TRX350 04-06
280.H0307C	CANVAS	TRX400FW 96-00
280.H0550C	CANVAS	TRX420 07-13
280.H0604C	CANVAS	TRX420/FA/FM/FE 2014
280.H0309C	CANVAS	TRX450 98-04
280.H0476C	CANVAS	TRX500 01-04 Rubicon
280.H0526C	CANVAS	TRX500FA 05-12 / TRX500FM 05-11
280.H0590C	CANVAS	TRX500FM 12-13
280.H0604C	CANVAS	TRX500FA/FM/FE 2014
280.H0515C	CANVAS	TRX650 03-04

SEAT OVER COVERS



Kawasaki

ATV City Part No.	Description	Model
280.K0194C	CANVAS	KLF300B 2WD
280.K0198C	CANVAS	KLF300C / 400B 4x4
280.K0117C	CANVAS	KVF360
280.K0110C	CANVAS	KVF650
265.18033	ProtekX	Mule 2500/ 3010/ 4010 Bench Type
265.73087	ProtekX	Mule 610 Bench Type

Polaris

ATV City Part No.	Description	Model
280.PL040C	CANVAS	Polaris Sports/Magnum 95-03
280.PL007C	CANVAS	Polaris Sportsman 500/700 05-11
280.PL011C	CANVAS	Polaris XP550/850 09-12
265.18026	ProtekX	Polaris Ranger XP/HD 09

Suzuki

ATV City Part No.	Description	Model
280.S0351C	CANVAS	LTF250 Ozark
280.S0306C	CANVAS	LTF250/300 99-04 King Quad
280.S0348C	CANVAS	LTF/LTA400 Eiger
280.S0413C	CANVAS	LTA/LTF400 King Quad 08-13
280.S0407C	CANVAS	LTA450/500 07-12
280.S0376C	CANVAS	LTA700/750 05-12

Yamaha

ATV City Part No.	Description	Model
280.Y0192C	CANVAS	YFM250 Bear Tracker 02
280.Y0317C	CANVAS	YFM350 / 400 Manual 96-98
280.Y0294C	CANVAS	YFM350 Bruin 04-06
280.Y0363C	CANVAS	YFM350 Grizzly 07-11
280.Y0045C	CANVAS	YFM400A 99-06
280.Y0198C	CANVAS	YFM450 Kodiak 03-08
280.Y0383C	CANVAS	YFM450 Grizzly 03-12
280.Y0186C	CANVAS	YFM660 Grizzly
280.Y0361C	CANVAS	YFM550 / 700 Grizzly 07-11

WORKSHOP TOOLS AND CONSUMABLES



the best part of your atv

- 1: BEARINGS, BUSH KITS, BALLJOINTS
- 2: BRAKING
- 3: BULLBARS, MUDFLAP KITS
- 4: CABLES
- 5: CARBURETTOR PARTS
- 6: DRIVE LINE / CVT BELTS / AXLES
- 7: ELECTRICAL
- 8: EXHAUSTS
- 9: MISCELLANEOUS
- 10: FILTERS
- 11: SEAT COVERS, OVER COVERS
- 12: WORKSHOP TOOLS AND CONSUMABLES
- 13: TYRES / TUBES / RIMS
- 14: ENGINE COMPONENTS
- 15: SPRAYERS & SPRAYER ACCESSORIES



12: WORKSHOP TOOLS AND CONSUMABLES



WORKSHOP TOOLS AND CONSUMABLES



Safety Gear

ATV City Part No.	Description
285.0090	Ear Defend0ers
285.0110	Safety Glasses



Cable Ties

ATV City Part No.	Description	Quantity
120.0085	Cable Ties 203 x 4.6	100
120.0090	Cable Ties 368 x 4.8	100
120.0100	Cable Ties 100 x 2.5	100
120.0105	Cable Ties 292 x 3.6	100



Tax Disc Holder

ATV City Part No.	Description
120.0175	Tax Disc Holder



Fuel Filter/Hose

ATV City Part No.	Pic	Description	Quantity
120.0180	A	Fuel Filter Nylon 1/4" 2" Long	1
120.0183	B	PVC Fuel Hose 8mmx10m	1
120.0184	C	10-12mm Fuel Hose Clamp	10
285.0020	D	Fuel-Clamp Pink	1



Fender/Mudguard Fasteners

ATV City Part No.	Description	Quantity
120.0190	Mudguard Fasteners Nut/Bolt	100
120.0195	Honda Outer Fender Rivets	10



Tape and Stickers

ATV City Part No.	Description	Quantity
120.0360	Service Reminder Stickers	250
120.0400	Insulation Tape 10m	10

Miscellaneous

Filters

Seat Covers

Tools

Tyres

Engine Parts

Sprayers

WORKSHOP TOOLS AND CONSUMABLES

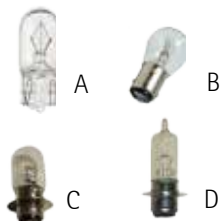

Bulbs

ATV City Part No.	Pic	Description	Quantity
175.0005	A	Bulb 12v 5w Capless	10
175.0010	B	Bulb 12v 21/5w 2pin 15d	10
175.0015	C	Bulb 12v 25/25w 1pin	10
175.0020	D	Bulb 12v 25/35w 1pin	1



Workshop Gloves

ATV City Part No.	Description	Quantity
285.0175	Synthetic Stretch Gloves Large	100
285.0180	Synthetic Stretch Gloves Extra Large	100



Mini Blade Fuse

ATV City Part No.	Description	Quantity
177.0003	3A Blade Fuse	10
177.0010	10A Blade Fuse	10
177.0015	15A Blade Fuse	10
177.0020	20A Blade Fuse	10
177.0030	30A Blade Fuse	10



Rubber Bungees

ATV City Part No.	Description
120.0550	Rubber Bungee 10"
120.0555	Rubber Bungee 15"
120.0560	Rubber Bungee 20"
120.0565	Rubber Bungee 31"



Grips

ATV City Part No.	Description	Quantity
392.0020	Replacement Grips	1 Pair
392.0050	Pro Clean Grip Glue	1



WORKSHOP TOOLS AND CONSUMABLES



Pull Start Ropes

ATV City Part No.	Description	Quantity
120.0380	Pull Start Handle	1
120.0390	Pull Start Rope 5mm x 1.75m	5

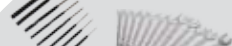
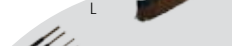
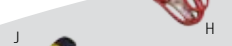

Workshop Tools

ATV City Part No.	Pics	Description
285.0010	A	Cable Luber
285.0015	B	CV Banding Tool (Ratchet type)
285.0030	C	Claw Pick Up Flexible
285.0035	D	Carb Tool Kit With Box
285.0070	E	4 Piece set of Plastic Funnels 50,75,100, 120mm
285.0080	F	Vernier Gauge, Metric and Imperial Readings
285.0085	G	5L Plastic Fuel Container
285.0100	H	2.2' PVC Coated Jump Leads
285.0120	I	Reload Snap Knife With 8 Snap-Off Blades.
285.0130	J	5 Metre Tape Measure
285.0140	K	24oz Solid Rubber Mallet
285.0150	L	Tap and Die set 40 Piece set 3-12mm
285.0160	M	Wire Brush
285.0170	N	8 Piece Punch Set, 200mm Long, 2.4mm - 9.5mm
285.0185	O	Combination Spanner Set 12 Piece 8-19mm



T-Bars

ATV City Part No.	Pic	Description
285.0025	A	T-Bar Allen Key Set 2/2.5/3/4.5/5/5.5/6/8/10mm
285.0050	B	T Bar Socket Set 8/10/12/13/14/17/19mm
285.0055	C	T-Bar Screw Driver No2 PH
285.0060	D	T-Bar Screw Driver No 3 PH
285.0065	E	T-Bar Allen Wrench Mini 4/5/6 mm

WORKSHOP TOOLS AND CONSUMABLES



Miscellaneous

Filters

Seat Covers

Tools

Tyres

Engine Parts

Sprayers

Tyre Fitting/Repair Products



ATV City Part No.	Pic	Description	Quantity
285.0040	A	Digital Tyre Pressure Gauge	1
285.0045	B	Tyre Valve Core Removal Tool	2 Pcs
120.0053	C	Tyre Valve Core	100
120.0055	D	Tyre Valve Stem (42mm)	10
120.0057	E	Tyre Valve Stem (35mm)	10
120.0058	F	Tyre Valve Cap	100
120.0250	G	Tyre Sealer 473cc	473cc
120.0275	H	Tyre Bead Sealer	945ml
120.0285	I	Tyre Mounting Paste + Brush	5kg
120.0060	J	Puncture Repair Kit	1
120.0065	K	Puncture Repair Strings	1

Reflectors



ATV City Part No.	Description
120.0245	Round 6mm Bolt-on Reflector Red
120.0248	Round 6mm Bolt-on Reflector Amber

Ratchet Tiedowns



ATV City Part No.	Description
120.0015	Tiedown Mini Ratchet 800kg x 3m
120.0020	Tiedown Ratchet Type 1500kg x 6m
120.0025	Tiedown Ratchet Type 3000kg x 6m
120.0030	Tiedown Ratchet Type 5000kg x 10m
120.0033	Tiedown Ratchet Type 5000kg x 18m

Tow Balls



ATV City Part No.	Description
120.0050	50mm Tow Balls



WORKSHOP TOOLS AND CONSUMABLES

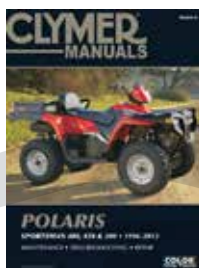

Clymer Manuals

ATV City Part No.	Description
270.M446	Honda TRX250 Recon 1997-2007
270.M346	Honda TRX300 1988-2000
270.M200	Honda TRX350 Rancher / Fourtrax 2000-2006
270.M205	Honda TRX450ES/S/FM/FE 1998-2004
270.M206	Honda TRX500 FM 2005-2011
270.M210	Honda TRX500FA Rubicon 2001-2004
270.M465	Kawasaki KLF220/250 1988-2003
270.M466	Kawasaki KLF300 1986-2004
270.M467	Kawasaki KLF400 1993-1999
270.M362	Polaris Magnum 425 / Big Boss 500 1996-1999
270.M365	Polaris Sportsman 400/450 & 500 / Explorer 1996-2008
270.M366	Polaris Sportsman 600/800/800 02-10
270.M483	Suzuki LT-4WD 87-98 Quad Runner
270.M483	Suzuki LT-4WDX 91-98 King Quad
270.M483	Suzuki LT-F250 Quad Runner 88-98
270.M499	Yamaha YFM80 Moto-4 85-88
270.M499	Yamaha YFM80 Badger 92-01
270.M499	Yamaha YFM80 Raptor 02-08
270.M489	Yamaha YFM250 89-91
270.M489	Yamaha YFB250 92-94
270.M490	Yamaha YFM350FW Big Bear 87-99
270.M490	Yamaha YFM400FW Kodiak 00-04
270.M285	Yamaha YFM660 Grizzly 02-07

Plain Nuts

ATV City Part No.	Description	Quantity
310.0004	M4 AF7 P.0.7	25
310.0005	M5 AF8 P.0.8	25
310.0006	M6 AF10 P1.0	25
310.0008	M8 AF12 P1.25	25
310.0010	M10 AF14 P1.25	25
310.0012	M12 AF17 P1.25	10



WORKSHOP TOOLS AND CONSUMABLES

Miscellaneous

Filters

Seat Covers

Tools

Tyres

Engine Parts

Sprayers

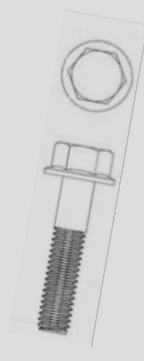

Flanged Nuts



ATV City Part No.	Description	Quantity
310.0015	M5 AF8 P.08	25
310.0016	M6 AF10 P1.0	25
310.0018	M8 AF12 P1.25	25
310.0020	M10 AF14 P1.25	25
310.0022	M12 AF17 P1.25	10

Nyloc Nuts

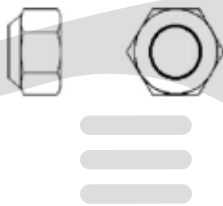

ATV City Part No.	Description	Quantity
310.0025	M5 AF8 P.08	25
310.0026	M6 AF10 P1.0	25
310.0028	M8 AF12 P1.25	25
310.0030	M10 AF14 P1.25	25
310.0032	M12 AF17 P1.25	10

Slotted / Castle Nuts



ATV City Part No.	Description	Quantity
310.0040	M10 AF17 P1.25	10
310.0042	M12 AF17 P1.25	10
310.0044	M14 AF19 P1.25	10

Domed Nuts



ATV City Part No.	Description	Quantity
310.0056	M6 AF10 P1.0	25
310.0058	M8 AF12 P1.25	25
310.0060	M8 AF12 P1.25	25



WORKSHOP TOOLS AND CONSUMABLES



Split Pins



ATV City Part No.	Description	Quantity
310.0070	M1.6X20	50
310.0085	M3.2X40	50
310.0090	M4.0X45	50

Flat Washer



ATV City Part No.	Description	Quantity
310.0105	M5 OD10	50
310.0106	M6 OD12	50
310.0108	M8 OD16	50
310.0110	M10 OD18	50
310.0112	M12 OD20	25

Flat Alloy Washer



ATV City Part No.	Description	Quantity
310.0116	M6 OD12	25
310.0118	M8 OD15	25
310.0120	M10 OD18	25
310.0122	M12 OD20	25

Flat Bumper Washer



ATV City Part No.	Description	Quantity
310.0125	M6 OD20	25
310.0130	M6 OD30	25
310.0135	M8 OD25	25

Spring Washer



ATV City Part No.	Description	Quantity
310.0145	M5 OD9	50
310.0146	M6 OD12	50
310.0148	M8 OD12	50
310.0150	M10 OD18	50
310.0152	M12 OD21	25

Miscellaneous

Filters

Seat Covers

Tools

Tyres

Engine Parts

Sprayers

WORKSHOP TOOLS AND CONSUMABLES

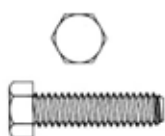
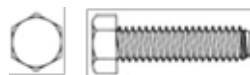

Plain Bolts

ATV City Part No.	Description
310.0205	M5X15 (HT AF8) P0.8
310.0210	M5X40 (HT AF8) P0.8
310.0225	M6X15 (HT AF10) P1.0
310.0230	M6X20 (HT AF10) P1.0
310.0235	M6X25 (HT AF10) P1.0
310.0240	M6X30 (HT AF10) P1.0
310.0245	M6X35 (HT AF10) P1.0
310.0250	M6X40 (HT AF10) P1.0 - PT
310.0255	M6X45 (HT AF10) P1.0 - PT
310.0260	M6X50 (HT AF10) P1.0 - PT
310.0265	M6X60 (HT AF10) P1.0 - PT
310.0270	M6X100 (HT AF10) P1.0 - PT
310.0275	M8X12 (HT AF12) P1.25
310.0280	M8X15 (HT AF12) P1.25
310.0285	M8X20 (HT AF12) P1.25
310.0290	M8X25 (HT AF12) P1.25
310.0295	M8X30 (HT AF12) P1.25
310.0300	M8X35 (HT AF12) P1.25
310.0305	M8X40 (HT AF12) P1.25 - PT
310.0310	M8X45 (HT AF12) P1.25 - PT
310.0315	M8X50 (HT AF12) P1.25 - PT
310.0320	M8X60 (HT AF12) P1.25 - PT
310.0325	M8X100 (HT AF12) P1.25 - PT
310.0330	M10x20 (HT AF14) P1.25
310.0335	M10x25 (HT AF14) P1.25
310.0340	M10x30 (HT AF14) P1.25
310.0345	M10x35 (HT AF14) P1.25
310.0350	M10X40 (HT AF14) P1.25 - PT
310.0355	M10X50 (HT AF14) P1.25 - PT
310.0360	M10X60 (HT AF14) P1.25 - PT
310.0365	M10X100 (HT AF14) P1.25 - PT

HT = 8.8 Grade High Tensile AF = Across Flats PT = Part Thread



WORKSHOP TOOLS AND CONSUMABLES



Plain Bolts (continued)

ATV City Part No.	Description
310.0370	M12X25 (HT AF17) P1.25
310.0375	M12X60 (HT AF17) P1.25- PT

Flange Bolts

ATV City Part No.	Description	Quantity
310.0410	M6X10 (HT AF10) P1.0	25
310.0412	M6X12 (HT AF10) P1.0	25
310.0416	M6X16 (HT AF10) P1.0	25
310.0420	M6X20 (HT AF10) P1.0	25
310.0425	M6X25 (HT AF10) P1.0	25
310.0430	M6X30 (HT AF10) P1.0	25
310.0435	M6X35 (HT AF10) P1.0	25
310.0440	M6X40 (HT AF10) P1.0 - PT	25
310.0445	M6X45 (HT AF10) P1.0 - PT	25
310.0450	M6X50 (HT AF10) P1.0 - PT	25
310.0455	M6X55 (HT AF10) P1.0 - PT	25
310.0460	M6X60 (HT AF10) P1.0 - PT	25
310.0465	M6X100 (HT AF10) P1.0 - PT	25
310.0470	M8X16 (HT AF12) P1.25 - PT	25
310.0475	M8X20 (HT AF12) P1.25	25
310.0480	M8X25 (HT AF12) P1.25	25
310.0485	M8X30 (HT AF12) P1.25	25
310.0490	M8X35 (HT AF12) P1.25	25
310.0495	M8X40 (HT AF12) P1.25 - PT	25
310.0500	M8X45 (HT AF12) P1.25 - PT	25
310.0505	M8X50 (HT AF12) P1.25 - PT	25
310.0510	M8X60 (HT AF12) P1.25 - PT	25
310.0515	M10X20 (HT AF14) P1.25	25
310.0520	M10X25 (HT AF14) P1.25	25
310.0525	M10X30 (HT AF14) P1.25	25

HT = 8.8 Grade High Tensile AF = Across Flats PT = Part Thread



Miscellaneous

Filters

Seat Covers

Tools

Tyres

Engine Parts

Sprayers

WORKSHOP TOOLS AND CONSUMABLES

Miscellaneous

Filters

Seat Covers

Tools

Tyres

Engine Parts

Sprayers



Flange Bolts (ctd)

ATV City Part No.	Description	Quantity
310.0515	M10X20 (HT AF14) P1.25	25
310.0520	M10X25 (HT AF14) P1.25	25
310.0525	M10X30 (HT AF14) P1.25	25
310.0530	M10X35 (HT AF14) P1.25	25
310.0535	M10X40 (HT AF14) P1.25 - PT	25
310.0540	M10X50 (HT AF14) P1.25 - PT	25
310.0545	M10X60 (HT AF14) P1.25 - PT	25
310.0550	M10X100 (HT AF14) P1.25 - PT	10
310.0555	M12X20 (HT AF17) P1.25	10
310.0560	M12X30 (HT AF17) P1.25 - PT	25
310.0565	M12X40 (HT AF17) P1.25	10

Small Head Flange Bolts

ATV City Part No.	Description	Quantity
310.0612	M6X12 (HT AF8) P1.0	25
310.0616	M6X16 (HT AF8) P1.0	25
310.0620	M6X20 (HT AF8) P1.0	25
310.0625	M6X25 (HT AF8) P1.0	25
310.0630	M6X30 (HT AF8) P1.0	25
310.0635	M6X35 (HT AF8) 91.0	25
310.0640	M6X40 (HT AF8) P1.0	25
310.0645	M6X45 (HT AF8) P1.0	25
310.0650	M6X50 (HT AF8) P1.0	25
310.0655	M6X55 (HT AF8) P1.0	25
310.0660	M6X60 (HT AF8) P1.0	25

HT = 8.8 Grade High Tensile AF = Across Flats PT = Part Thread



Cleaners

ATV City Part No.	Description	Quantity
210.0040	Brakleen	500ml
210.0045	Brakleen	5Ltr



Brake parts cleaner. Powerful and fast-drying cleaner. Cleans and degreases brakes and clutches. Removes oil, brake fluid, grease and hardened deposits. Leaves no residue.



WORKSHOP TOOLS AND CONSUMABLES



Cleaners (continued)



ATV City Part No.	Description	Quantity
210.0050	Quickleen	500ml



Solvent cleaner and degreaser for service and repair. A fast drying and powerful cleaner, it cleans and degreases all metal parts, machines and tools. CRC Quickleen penetrates quickly to remove grease, oil and dirt.



ATV City Part No.	Description	Quantity
210.0052	Air Sensor Cleaner	200ml



Effective cleaner for Mass Air Flow sensors. Both the hot-wire and hot-plate type sensors can be cleaned easily for optimal performance of the injection system. CRC Air Sensor Clean is a high purity, effective precision cleaning solvent designed to meet today's environmental challenges. Based on fast drying naphthenic solvent without chlorinated glycol ether components.



ATV City Part No.	Description	Quantity
210.0054	Electronic Cleaner	200ml



Electronic components cleaner. Removes oil, dirt and dust from electronic components on printed circuit boards, connectors, relays and switches. Leaves no residue. Test plastic compatibility prior to use.



ATV City Part No.	Description	Quantity
210.0056	Precision Cleaner	300ml



Very mild precision cleaner. Removes light oils, fingerprints and dust. Compatible with commonly used electronic components. CRC Electronic cleaner cleans electrical contacts and switches on radios, CD and cassette player, alarm systems etc.



ATV City Part No.	Description	Quantity
210.0060	Carburettor Cleaner	300ml



Cleans the carburettor and fuel dispensing system. Dissolves gum and resin. Removes carbon deposits and varnish. CRC Carburettor Cleaner makes the engine run smoother. Can be used on carburettors of cars, chainsaws, lawnmowers, alarm systems etc.

WORKSHOP TOOLS AND CONSUMABLES



Cleaners (continued)



ATV City Part No.	Description	Quantity
210.0065	Battery Pole Protect	200ml



Soft, dry, lead-free protective coating that keeps moisture, salts and road grime from corroding metal contacts. Prevents corrosion-related leakage. Red colour provides easy visual inspection.



ATV City Part No.	Description	Quantity
210.0070	Motor Clean	500ml



Extra powerful engine surface cleaner and degreaser. Quickly removes tar, grease, oil and road salt from the outside of all engines. Easy to use with the CRC aerosol trigger sprayer: just spray it on a cold or warm (NOT HOT) engine, let it work for a few minutes and rinse off with jet of water.



ATV City Part No.	Description	Quantity
210.0460	AirCo Professional	400ml



Eliminates the disturbing smell generated by contamination of the evaporator in the air conditioning system. The CRC Airco Cleaner cleans the air conditioning system in an optimal way by means of its unique foam formula. The product leaves fresh smell.



ATV City Part No.	Description	Quantity
210.0470	AirCo Klean	200ml



Airco Klean removes and prevents unpleasant odours generated by contamination of the evaporator in the air conditioning system of cars, trucks and agricultural machines, especially after a period of inactivity (winter). It reconditions the air conditions system in an optimal way by means of its unique and easy application method, leaving a fresh odour in the vehicle.



ATV City Part No.	Description	Quantity
210.0490	Kontakt 60	200ml



Contact de-oxidiser. Dissolves corrosion layers, restoring the metal contact. Optimum contact conditions are reached when residue's dissolved using Kontakt 60 prior to protection with Kontakt 61.



WORKSHOP TOOLS AND CONSUMABLES



Cleaners (continued)

ATV City Part No.	Description	Quantity
210.0500	Kontakt 61	200ml



Contact lubricant & corrosion inhibitor. Builds a thin protective film, preventing corrosion and wear. Provides a low, stable contact resistance, without leakage currents or short circuits between the contact surfaces.



Multipurpose

ATV City Part No.	Description	Quantity
210.0010	5-56 spray	300ml
210.0020	5-56 spray	400ml
210.0025	5-56 spray	5ltr



Multipurpose service Spray. The thin oil with additives loosens rusted screw connections, lubricates hinges and stops squeaks. 5-56 displaces moisture and thus helps wet engines to start and prevents electrical failure. It frees and cleans sticking mechanisms and protects metals against corrosion in a humid, corrosive atmosphere.



Lubricants - Oil

ATV City Part No.	Description	Quantity
210.0080	Penetrating Oil + MOS2	300ml



Penetrating and lubricating oil. The thin oil penetrates through the finest openings and disperses rust, scale and other dirt. It will be easier to loosen metal parts and screw connections seized by dirt, rust, corrosion or dried-up greasy deposits. Leaves a lubricating MoS2 Film



ATV City Part No.	Description	Quantity
210.0090	Rost Flash Spray	500ml



The penetrating oil with freeze-shock effect quickly loosens rusted or squeezed connections. The freezing effect (-40C degrees) cracks the rusted or squeezed surfaces and the high purity penetration oil can easily find its way through the fissures. CRC Rost Flash easily loosens seized connections. To be applied on threaded connections, splines, rods, etc.

Miscellaneous

Filters

Seat Covers

Tools

Tyres

Engine Parts

Sprayers

WORKSHOP TOOLS AND CONSUMABLES

Miscellaneous

Filters

Seat Covers

Tools

Tyres

Engine Parts

Sprayers



Lubricants - Oil (ctd)

ATV City Part No.	Description	Quantity
210.0100	Silicone Spray	200ml
210.0110	Silicone Spray	400ml



Lubricates and protects. Renovates plastic, rubber and wooden surfaces, giving them a new shine. CRC Silicone provides excellent lubrication, especially between different materials. Prevents hardening and freezing of rubber. Also lubricates plastic assemblies.



ATV City Part No.	Description	Quantity
210.0113	Multilube	500ml



A lubricant with an adequate penetration and an extremely good resistance to splash water. Resists vibrations, extreme pressure and peak forces. CRC Multilube has a temporary blue transparent appearance and does not drip off. To be used on most common friction points on cars, trucks, caravans and at home.



ATV City Part No.	Description	Quantity
210.0115	Lockoil	100ml

Long Lasting, non-greasy lubricant for locks and fine mechanisms. The detergent oil first dissolves and removes the dirt and will not resinify afterwards, providing improved functionality and longer lubrication.



ATV City Part No.	Description	Quantity
210.0120	Chain Lube	200ml

A strong adhering lubricant with anti-corrosion additive. Excellent for the lubrication of friction points that have to withstand bad weather conditions or other rough conditions (salt, cold, hot water) at high speeds. O-ring compatible. Applications: Motorcycles Chains, open gear wheels, open bearings, shafts, spindles etc.



ATV City Part No.	Description	Quantity
210.0130	Adhesive Lubricant	500ml

A lubricant with good adhesion properties. Excellent for the lubrication of friction points that have to withstand bad weather conditions or other rough conditions (salt, cold, hot water) at lower speeds. The special anti-corrosion additives protect the metal parts. O-ring compatible. Applications; Open gear wheels, open bearings, shafts, spindles etc.



WORKSHOP TOOLS AND CONSUMABLES



Lubricants - Oil (ctd)



ATV City Part No.	Description	Quantity
210.0140	High Temp Grease	100ml
210.0150	High Temp Grease	400g

A lithium complex grease with EP additive. Ideal for lubrication of bearings (high speed, moderate load) exposed to higher temperatures. Applications; bearings of electro-motors, road construction machines etc.



ATV City Part No.	Description	Quantity
210.0160	Multipurpose Grease	100ml
210.0170	Multipurpose Grease	400g

Multipurpose lithium grease for general machinery lubrication. Reduces friction and wear. Ideal for lubrication of friction and non-friction bearings. Has excellent anti-corrosion properties. Can also be used as a universal lubricant for cars, machinery and tools.



ATV City Part No.	Description	Quantity
210.0180	Super Adhesive Grease	100ml
210.0190	Super Adhesive Grease	400g

Multipurpose lithium grease for general machinery lubrication. Reduces friction and wear. Ideal for lubrication of friction and non-friction bearings. Has excellent anti-corrosion properties. Can also be used as a universal lubricant for cars, machinery and tools.



ATV City Part No.	Description	Quantity
210.0200	Super Longterm Grease	100ml
210.0210	Super Longterm Grease	400g

A black, extreme pressure lithium grease with MOS2. Resists high mechanical loads, impact loads and vibrations. Provides a good oxidation stability and a good corrosion protection. Ideal for universal joints. Application; drive shaft, alternator and coupling bearings.

Miscellaneous

Filters

Seat Covers

Tools

Tyres

Engine Parts

Sprayers

WORKSHOP TOOLS AND CONSUMABLES



Lubricants – Oil (ctd)



ATV City Part No.	Description	Quantity
210.0220	White Lithium Grease	300ml

A white universal grease with PTFE that sprays like an oil and sets like a grease. Provides long lasting lubrication to all moving parts. Reduces friction and wear. CRC White lithium grease leaves a visible white, water resistant film. Applications; hinges, guidings.



ATV City Part No.	Description	Quantity
210.0230	Braklube	100ml
210.0240	Braklube	300ml

A special metal-free lubricant for brake parts, can also be used for aluminium parts. Keeps critical parts free for optimum braking efficiency. Resists water and high temperature. Will not run off callipers and drum brake systems. Prevents corrosion. Do not use on Rotors and friction side of brake pads.

Lubricant Paste



ATV City Part No.	Description	Quantity
210.0250	Copper Paste Tube	100ml
210.0260	Copper Paste Aerosol	300ml
210.0270	Copper Paste	500g

Effective anti-seize and mounting paste. High quality product based on a drop-free paste with very fine copper powder. Contains anti-corrosion additives, is water resistant and has separating properties up to 1100 degrees C. Used as a paste on screws and bolts, as an effective anti-seize lubricant on connections or on brake pads to absorb disc brake noise.

Corrosion Protectors



ATV City Part No.	Description	Quantity
210.0280	Zinc	400ml

Cathodic protection, even for damaged galvanised parts. Zinc based coating with excellent adhesion to metal surfaces. The high zinc content is sacrificed during the corrosion process and so provides a galvanic protection of the treated metal. The dry coating contains a maximum amount of zinc (purity 98%) and offers protection, even when the top coat gets scratched. The dry coating is matt and has an excellent surface structure to be painted.



WORKSHOP TOOLS AND CONSUMABLES



Corrosion Protectors (ctd)

ATV City Part No.	Description	Quantity
210.0285	Alu HiTemp	400ml

High temperature corrosion protection. Forms a hard film after heating, based on silicone resins and aluminium pigments. This film will not burn or peel off at higher temperatures. CRC Alu HiTemp resists temperature fluctuations very well. Applications; Exhaust systems, heat exchangers.



ATV City Part No.	Description	Quantity
210.0300	Galva Brite	400ml

Protective zinc-aluminium coating. Combines corrosion protection properties with the lustre look of aluminium. Recommended as a final coating for the repair of hot-galvanized steel constructions. Resists corrosion, peeling and fading. For galvanized surfaces, we recommend to use CRC Zinc as a primer before applying CRC GalvaBrite.



Paints

ATV City Part No.	Description	Quantity
210.0320	Pro Paint Black Matt	500ml
210.0340	Pro Paint Silver	500ml

Quick drying, universal acrylic paint. Available in different colours, provides a good protection to steel rims. Can also be used on other metals, wood, concrete, glass and many plastics on the car. Also suitable around the house and for many hobby purposes.



Speciality

ATV City Part No.	Description	Quantity
210.0345	Disc Brake Quiet	100ml

Paste that cures as a tough rubber. Prevents and stops disc brake noise and vibration.

Miscellaneous

Filters

Seat Covers

Tools

Tyres

Engine Parts

Sprayers

WORKSHOP TOOLS AND CONSUMABLES



Speciality (continued)



ATV City Part No.	Description	Quantity
210.0350	Exhaust Repair Bandage	1

For reparation of large holes and cracks in exhaust systems. Quick and easy to use without welding and/or disassembly. The bandage starts hardening while driving. To reinforce the bandage or to repair small holes use CRC Exhaust Repair gum.



ATV City Part No.	Description	Quantity
210.0360	Exhaust Mounting Paste	150g

Mounting and sealing paste for all exhaust components. Facilitates assembly and dis-assembly and seals at the same time. Apply the paste before mounting; the hardening will take place automatically by the exhaust heat.



ATV City Part No.	Description	Quantity
210.0365	Exhaust Repair Gum	200g

For the repair of small holes and cracks in exhaust or catalyst systems. Quick and easy to use without welding and /or disassembly. The putty hardens completely after a few minutes drive. For the repair of large holes, use CRC Exhaust Repair Bandage.



ATV City Part No.	Description	Quantity
210.0370	Gasket Remover	300ml

Very effective solvent blend for the removal of heavy deposits. Removes baked-on adhesives, putties and gaskets. Dissolves resins, grease, oil and tar. Strips paint and lacquers. Only to be used on metal surfaces.



WORKSHOP TOOLS AND CONSUMABLES



Speciality (continued)



ATV City Part No.	Description	Quantity
210.0380	Super Gasket Remover	400ml

A fast action stripper. Removes baked-on and carbonized deposits of adhesives, putties, gasket cement. Dissolves resins, grease, oil and tar. Strips paints, lacquers and varnish.

Adhesives and Sealants



ATV City Part No.	Description	Quantity
210.0390	Soft Lock	50ml

A blue coloured medium strength anaerobic adhesive. CRC Soft Lock is used to lock those threaded connections that will have to be dismantled in the future by use of normal tools and without damaging the parts or fittings. Recommended for use on threaded connections from M5 to M16.



ATV City Part No.	Description	Quantity
210.0400	Extra Lock	50ml

A green coloured high strength anaerobic adhesive. CRC Extra Lock is used to lock those threaded connections that do not need to be dismantled in the near future. Also suitable for locking bearings and axles. Recommended for use on threaded connections from M5 to M16, as well as on axles, bearings and bushings.



ATV City Part No.	Description	Quantity
210.0400	Quick Fix	20g
210.0420	Quick Fix	3g

A cyanoacrylate adhesive, designed for general use. CRC Quick Fix has a relatively slow curing time, enabling correct positioning and precise work.



ATV City Part No.	Description	Quantity
210.0425	Rigid Seal	50ml

An orange colored high strength anaerobic adhesive. CRC Rigid Seal is used to seal stiff, machined metal flanges that are used in industrial piping, engine covers, gearboxes and hydraulic or pneumatic installations. Excess of material can be Wiped off with a dry cloth or is dissolved in oil.

Miscellaneous

Filters

Seat Covers

Tools

Tyres

Engine Parts

Sprayers

WORKSHOP TOOLS AND CONSUMABLES

Miscellaneous

Filters

Seat Covers

Tools

Tyres

Engine Parts

Sprayers



Miscellaneous

ATV City Part No.	Description	Quantity
210.0430	Gun Care	150ml



After the firing session, clean, lubricate and protect the gun with CRC Gun Care. It frees and removes powder residues, penetrates very well and drives out moisture. It gives an excellent off-season storage protection. Resists temperatures down to -50C°



ATV City Part No.	Description	Quantity
210.0435	Motor Starter Aerosol	200ml



Instant cold start for diesel and petrol engines. Ensures instant engine start at low temperature, in humid conditions and after long periods of standstill. Avoids battery strain and exhaustion. Contains special additives to prevent engine wear. Can be used for car, trucks, tractors, lawnmowers and chainsaws.



ATV City Part No.	Description	Quantity
210.0440	Fix	300ml
210.0450	Fix	500ml



Seals and inflates tires in a few seconds. Leaves a rubber film on the inside tyre wall that seals the puncture. Makes use of the propellant to inflate the tyre to driving pressure. This is NOT a permanent solution.



ATV City Part No.	Description	Quantity
210.0480	Bike Oil	150ml



Lubricates most moving parts on bikes. Penetrates in the hardest to reach areas. Protects against corrosion and rust, ideal for winter storage. Displaces moisture and water. Applications; chains, cogwheels, sprockets, brake mechanism and locks.



WORKSHOP TOOLS AND CONSUMABLES



Car Care



ATV City Part No.	Description	Quantity
210.0510	Textile Clean	400ml



Special instant foaming formula. Removes stains from upholstery, carpets, fabric, vinyl and leather. Cleans seats, roof linings, door panels and car carpets. CRC Textile Clean can also be used in household applications.



ATV City Part No.	Description	Quantity
210.0520	Cockpit Shine	400ml



Spray containing silicones, cleans and renovates dashboards and car interiors. Removes stains and leaves a shiny, water-repelling film. Protects plastics against fading and hardening. For the maintenance of rubber seals, we recommend CRC Silicone.



ATV City Part No.	Description	Quantity
210.0530	Cockpit Matt	400ml



A Silicone free cleaner for plastic in the car. Cleans and renovates dashboards and car interiors. Removes stains and tar deposits. CRC Cockpit Matt leaves a matt, water repelling film. Protects plastic against fading and hardening.



ATV City Part No.	Description	Quantity
210.0540	Cockpit Shine Sponge	1



Cockpit sponge impregnated with silicone, cleans the car interior and refreshes the colours. It leaves a long-lasting, antistatic film. The cockpit sponge renovates plastic, rubber, vinyl, leather and wooden surface.

Miscellaneous

Filters

Seat Covers

Tools

Tyres

Engine Parts

Sprayers

WORKSHOP TOOLS AND CONSUMABLES



Car Care (continued)



ATV City Part No.	Description	Quantity
210.0550	Glass Clean	400ml



A window cleaner with an active foam formula for removal of greasy marks, grim, tar and squashed insects. The special, stable foam will not run off. CRC Glass Clean also cleans headlights, bumpers and car body.



ATV City Part No.	Description	Quantity
210.0560	Tire Shine	400ml



An active foam that makes your tires look as good as new. Removes stains on tires. Leaves a clear, inert film that repels dirt. CRC Tire Shine protects the rubber against discoloration and oxidation.

Additives



ATV City Part No.	Description	Quantity
210.0600	Bio Diesel Additive	200ml

Prevents and reduces fuel injection system deposits.



ATV City Part No.	Description	Quantity
210.0610	Diesel Additive	200ml

Increases Cetane level, optimizes fuel consumption. Cleans and prevents wear of diesel pumps and injection systems. Ensures smoother running of the engine and a better cold start.



ATV City Part No.	Description	Quantity
210.0620	Diesel Anti Paraffin	200ml

Improves the flow characteristics of diesel fuel at low temperatures. Prevents obstruction of the filter. Avoids cold start problems



WORKSHOP TOOLS AND CONSUMABLES



Additives (continued)

ATV City Part No.	Description	Quantity
210.0630	Diesel Dryer	200ml

Dissipates water in diesel fuel to minimize the risk of interruptions in the fuel supply to the injectors.



ATV City Part No.	Description	Quantity
210.0640	Diesel Smoke Stop Car	200ml
210.0650	Diesel Smoke Stop Truck	200ml

Anti Smoke for Diesel car engines or for truck engines



ATV City Part No.	Description	Quantity
210.0660	Fuel Stabiliser	200ml

Controls and reduces the formation of gum, varnish and peroxides during storage of diesel and gasoline.



ATV City Part No.	Description	Quantity
210.0670	Fuel System cleaner	200ml

Thorough cleaning from tank to combustion



Additives

ATV City Part No.	Description	Quantity
210.0680	Gasoline Additive	200ml

Reduces failures by keeping the fuel distribution system clean. Protects the system against rust and corrosion. Optimizes fuel consumption and combustion.

Miscellaneous

Filters

Seat Covers

Tools

Tyres

Engine Parts

Sprayers

WORKSHOP TOOLS AND CONSUMABLES



Miscellaneous

Filters

Seat Covers

Tools

Tyres

Engine Parts

Sprayers



Additives (continued)

ATV City Part No.	Description	Quantity
210.0690	Injector Cleaner	200ml

Instant cleaner for the injector system. Removes the deposits in the injectors and also prevents the formation of those carbon deposits. CRC Injector Cleaner ensures an optimal fuel spray, optimizes the engine performance and the fuel consumption. Compatible with fuels and catalyst systems.



ATV City Part No.	Description	Quantity
210.0700	Motor Flush	200ml

Instant cleaner for the complete oil system. Removes the deposits on the inner parts of the motor. Improves the engine performance. CRC Motor Flush disperses deposits, gums and sludge in the oil. Add to the old oil, run engine for a few minutes before oil change. When flushing the old oil, the dispersed dirt will be removed.



ATV City Part No.	Description	Quantity
210.0710	Octane Booster	200ml

Boosts the octane level and gives extra lubricity to the valve seats, thus preventing valve seat recession on both old and new engines.



ATV City Part No.	Description	Quantity
210.0720	Oil Additive	200ml

Stabilizes the viscosity of the oil, optimizes oil consumption and compression. Reduces engine deposits and pollution. Protects the oil system against corrosion and oxidation.



ATV City Part No.	Description	Quantity
210.0730	Oil Drip Stop	200ml

Restores the seal-metal contacts and even stops light motor oil leaks, reduces oil loss. CRC Oil Drip Stop also stabilizes the oil viscosity.



ATV City Part No.	Description	Quantity
210.0740	Radiation Clean	200ml

Prevents obstructions in the cooling system. Removes scale and rust from the inside of the radiator, providing an optimal heat exchange. CRC Radiator Clean protects against corrosion.



WORKSHOP TOOLS AND CONSUMABLES



ATV City Part No.	Description	Quantity
210.0750	Radiator Seal	200ml

Stops small leaks in the radiator/cooling system and prevents corrosion. CRC Radiator Seal is compatible with all commonly used cooling fluids and ant-freeze products.



ATV City Part No.	Description	Quantity
210.0760	Valve Cleaner	200ml

Effective cleaner for the removal of gum, varnish and carbon deposits. Eliminates compression loss, caused by valve deposits. Reduces fuel consumption.

Accessories



ATV City Part No.	Description	Quantity
210.0800	Marker Pen Yellow (Paint Pen)	1
210.0802	Marker Pen Red (Paint Pen)	1
210.0804	Marker Pen White (Paint Pen)	1
210.0806	Marker Pen Black (Paint Pen)	1
210.0810	Marker Pen Nibs (Paint Pen)	10

Marker pen for multi surface use. Excellent coverage thanks to the use of correction fluid technology. Can be used on wood, metal, rubber, glass, textile, paper, enamel, plastic, cardboard, tiles, etc.



ATV City Part No.	Description	Quantity
210.0820	Galvacolor Yellow 1004	500ml
210.0825	Galvacolor Violet 4001	500ml
210.0830	Galvacolor Red 3000	500ml
210.0835	Galvacolor White 9010	500ml
210.0840	Galvacolor Blue 5012	500ml
210.0845	Galvacolor Green 6010	500ml
210.0850	Galvacolor Brown 8001	500ml
210.0855	Galvacolor Black 9005	500ml
210.0860	Galvacolor Silver 9006	500ml

Aerosol paint that protects the metal from corroding. Zinc phosphate protective coating. Ideal for identification of utility conduits. Primer and topcoat in one. Short drying time. Conforms to the protective category C3 (ISO 12944-2)

WORKSHOP TOOLS AND CONSUMABLES



Miscellaneous

Filters

Seat Covers

Tools

Tyres

Engine Parts

Sprayers

Accessories (continued)



ATV City Part No.	Description	Quantity
210.0890	Power Stick Adhesive	500ml

High Strength Adhesive. Does not contain Methylene Chloride or other chlorinated solvents. CRC Power Stick has a long open bond time, allowing large areas to be covered before the film dries.



ATV City Part No.	Description	Quantity
210.9150	Counter Display Stand	1



ATV City Part No.	Description	Quantity
210.9200	Stand	1

Metal Grey Rack, Small. (Stock Not Included)



ATV City Part No.	Description	Quantity
210.9300	Hand Sprayer	1



ATV City Part No.	Description	Quantity
210.9310	Hand Pump	1





the best part of your atv

- 1: BEARINGS, BUSH KITS, BALLJOINTS
- 2: BRAKING
- 3: BULLBARS, MUDFLAP KITS
- 4: CABLES
- 5: CARBURETTOR PARTS
- 6: DRIVE LINE / CVT BELTS / AXLES
- 7: ELECTRICAL
- 8: EXHAUSTS
- 9: MISCELLANEOUS
- 10: FILTERS
- 11: SEAT COVERS, OVER COVERS
- 12: TOOLS
- 13: TYRES / TUBES / RIMS
- 14: ENGINE COMPONENTS
- 15: SPRAYERS & SPRAYER ACCESSORIES



13: TYRES & TUBES

TYRES - INNOVA



IA-8004 Mud Gear

ATV City Part No.	Size	Description
400.0252	25 x 12 x 9	4 ply E-mark
400.0359	23 x 10 x 10	4 ply E-mark
400.0365	24 x 11 x 10	6 ply E-mark
400.0375	25 x 12 x 10	4 ply E-mark
400.0420	23 x 8 x 11	4 ply E-mark
400.0440	24 x 8 x 11	4 ply E-mark
400.0460	24 x 9 x 11	4 ply E-mark
400.0470	24 x 10 x 11	4 ply E-mark
400.0490	24 x 8 x 12	4 ply E-mark
400.0500	25 x 8 x 12	4 ply E-mark
400.0510	25 x 8 x 12	6 ply E-mark
400.0700	25 x 10 x 12	4 ply E-mark
400.0710	25 x 10 x 12	6 ply E-mark
400.0715	25 x 11 x 12	6 ply E-mark
400.0720	25 x 12.5 x 12	6 ply E-mark
400.0723	26 x 9 x 12	6 ply E-mark
400.0730	26 x 10 x 12	6 ply E-mark
400.0740	26 x 12 x 12	6 ply E-mark
400.0800	26 x 9 x 14	6 ply E-mark
400.0810	26 x 11 x 14	6 ply E-mark
400.0900	27 x 9 x 12	4ply E-mark
400.0905	27 x 10 x 12	6 ply E-mark
400.0920	27 x 12 x 12	6 ply E-mark
400.0950	27 x 10 x 14	6ply E-mark
400.0980	27 x 12 x 14	6ply E-mark

Note # Recommended Tyre Pressures for
 Innova 26" & 27" tyres on a ATV are
 4 ply = 5 P.S.I
 6 ply = 7 P.S.I



TYRES - INNOVA



IA-8008 Hawk Gear

ATV City Part No.	Size	Description
400.0200	22 x 11 x 9	2 ply E-mark



IA-8003 Speed Gear

ATV City Part No.	Size	Description
400.0320	22 x 8 x 10	4 ply E-mark



IA-8009 Knobby Gear

ATV City Part No.	Size	Description
400.0010	145/70-6	2 ply E-mark
400.0120	22 x 11 x 8	2 ply



IA-8007 B Land Hawk

ATV City Part No.	Size	Description
400.0050	18 x 7 x 7	2 ply
400.0060	19 x 7 x 8	2 ply E-mark



IA-8022 Racer Tyres

ATV City Part No.	Size	Description
400.0175	20 x 11 x 9 (255/55 x 9)	E-mark
400.0295	21 x 7 x 10 (175/70 x 10)	E-mark
400.0300	18 x 10 x 10 (225/40 x 10)	E-mark
400.0355	22 x 10 x 10 (255/60 x 10)	E-mark
400.0515	25 x 8 x 12 (185/88 x 12)	E-mark
400.0690	25 x 10 x 12 (270/60 x 12)	E-mark



TYRES - INNOVA



IA-8040 Xtreme Radial

ATV City Part No.	Size	Description
400.0520	25 x 8 x 12	6 ply E-mark
400.0695	25 x 10 x 12	6 ply E-mark



IA8030 Cayman Turf

ATV City Part No.	Size	Description
405.1060	22.5 x 10 x 8	4 ply E-mark
405.2200	25 x 12 x 9	4ply E-mark
405.3370	22 x 9.5 x 10	4ply E-mark
405.3420	24 x 12 x 10	4ply E-mark



IA8028 Cayman AT

ATV City Part No.	Size	Description
405.1050	22.5 x 10 x 8	4 ply E-mark
405.2250	25 x 13 x 9	4 ply E-mark
405.3350	24 x 9.5 x 10	4 ply E-mark
405.3390	24 x 10.5 x 10	4 ply E-mark



TYRES - VEE RUBBER



VRM 189 Grizzly

ATV City Part No.	Size	Description
400.0250	22 x 12 x 9	4 ply
400.0360	23 x 11 x 10	4ply
400.0380	25 x 12.5 x 10	4ply
400.0400	22 x 7 x 11	4 ply E-mark
400.0450	24 x 9 x 11	4 ply
400.0475	24 x 10 x 11	4ply
400.0495	24 x 8 x 12	4 ply
400.0505	25 x 8 x 12	4 ply E-mark
400.0705	25 x 10 x 12	4 ply E-mark
400.0717	25 x 12.5 x 12	4ply
400.0721	26 x 8 x 12	4 ply
400.0745	26 x 12 x 12	4 ply



VRM 326

ATV City Part No.	Size	Description
400.0497	24 x 8 x 12	4 ply

TYRES - ARTRAX



AT-1201 MX Trax

ATV City Part No.	Size	Description
400.0290	21 x 7 x 10	4ply E-mark
400.0310	22 x 7 x 10	4ply E-mark



AT-1202 MX Trax

ATV City Part No.	Size	Description
400.0165	20 x 10 x 9	4ply E-mark
400.0170	20 x 11 x 9	4ply E-mark
400.0350	20 x 11 x 10	4ply



AT-1205 MX Trax Racing

ATV City Part No.	Size	Description
400.0285	20 x 6 x 10	2ply E-mark



AT-1206 MX Trax Racing

ATV City Part No.	Size	Description
400.0090	18 x 10 x 8	2ply E-mark
400.0150	19 x 10 x 9	2ply E-mark



AT-1307 Mudtrax

ATV City Part No.	Size	Description
400.0480	24 x 10 x 11	6ply E-mark
400.0485	24 x 8 x 12	6ply E-mark
400.0530	25 x 8 x 12	6ply E-mark
400.0680	25 x 10 x 12	6ply E-mark

ARTRAX



TYRES - COUNTRAX



AT-1301 Countrax

ATV City Part No.	Size	Description
400.0540	25 x 8 x 12	6ply E-mark
400.0670	25 x 10 x 12	6ply E-mark

TYRE FITMENT CHART



Arctic Cat

Model	Front Tyre	Rear Tyre
250 2WD/4WD (99-03)	23 x 8 -12	
250 2WD/4WD (01)		23 x 10 -12
250 2WD/4WD (02-03)		24 x 9 -12
250 2WD (99)		25 x 10 -12
250 2WD (00)		24 x 9 -12
300 2WD (98-03)	23 x 8 x 12	
300 4WD (98-00)	24 x 9 x 12	
300 4WD (01)	23 x 8-12	
300 4WD (02-03)	24 x 9-12	
300 2WD/4WD (98-00)		25 x 10 x 12
300 2WD/4WD (01)		23 x 10 -12
300 2WD/4WD (02-03)		25 x 10 - 12
375 2WD/4WD (02-03)	25 x 8 x 12	25 x 10 x 12
400 2WD/4WD (98-03)	25 x 8 x 12	25 x 10 x 12
400i 2WD/4WD (02-07)	25 x 8-12	25 x 11 - 12
DVX 400 2WD (04-05)	22 x 7-10	20 x 11 - 9
454 2WD/4WD (96-98)	25 x 8 x 12	25 x 10 x 12
500 4WD (98-99)	26 x 10.5 x 12	26 x 10.5 x 12
500 4WD (00-03)	25 x 8 -12	25 x 10-12
500i 4WD (02-07)	25 x 8 -12	25 x 11 - 12
650i 4WD (04-07)	26 x 8 -12	26 x 11 - 12
700i 4WD (07)	26 x 8 -12	26 x 11 - 12

Can-Am / Bombardier

Model	Front Tyre	Rear Tyre
Outlander 330 2WD/4WD (03-05)	25 x 8 x 12	25 x 10 x 12
Outlander 400 2WD/4WD (03-07)	25 x 8 x 12	25 x 10 x 12
Outlander 500 2WD/4WD (07)	26 x 8 x 12	26 x 10 x 12
Traxter 500 4WD (99-05)	25 x 8 x 12	25 x 10 x 12
Quest 500 4WD (00-05)	25 x 8 x 12	25 x 10 x 12
DS 650 (00-06)	21 x 7 x 10	20 x 11 x 9
Outlander 650 2WD/4WD (06-07)	26 x 8 x 12	26 x 10 x 12
Quest 650 4WD (00-05)	25 x 8 x 12	25 x 10 x 12
Outlander 800 2WD/4WD (06-07)	26 x 8 x 12	26 x 10 x 12

Dinli

Model	Front Tyre	Rear Tyre
DL 604 50cc		18 x 9.5 - 8
DL 801 350cc	21 x 7 - 10	20 x 11 - 9
DL 802 300cc	21 x 7 - 10	20 x 11 - 9
DL 901 450cc	21 x 7 - 10	20 x 11 - 9

Eton

Model	Front Tyre	Rear Tyre
Viper 40E	145/70 - 6	145/70 - 6
Viper 50E	145/70 - 6	145/70 - 6
Viper 70	145/70 - 6	145/70 - 6
Viper 90	18 x 7 - 8	18 x 9 - 8
Viper 150	21 x 7- 10	20 x 11 - 9
Viper 150R	21 x 7- 10	20 x 11 - 9
Yukon CXL-150	21 x 7- 10	22 x 10 - 10
Vector 250	21 x 7- 10	22 x 11 - 9

Goes

Model	Front Tyre	Rear Tyre
220	21 x 7 - 10	20 x 10 - 9
320 Max	22 x 7 - 10	22 x 10 - 10
450 X	21 x 7 - 10	20 x 11 - 9
520 Max	25 x 8 - 12	25 x 10 - 12

Honda

Model	Front Tyre	Rear Tyre
TRX 70 (86-97)	16 x 8 x 7	16 x 8 x 7
TRX 90 (93-03)	20 x 7 x 8	19 x 8 x 8
ATC 90/110 (Thru 81)		22 x 11 x 8
ATC 110/125/125M (82-87)		22 x 11 x 8
TRX 125 (87-88)	20 x 7 x 8	
TRX 125 (85-88)		22 x 10 x 8
ATC 185S (Thru 81)		22 x 11 x 8
ATC 185S (82-84)		22 x 11 x 8
ATC 185/200/Big Red (80-84)		25 x 12 x 9



TYRE FITMENT CHART



Honda

Model	Front Tyre	Rear Tyre
ATC 200S (84-85)		22 x 11 x 8
ATC 200M (Thru 85)		25 x 12 x 9
ATC 200X (83-85)		22 x 11 x 8
ATC 200X (86-87)		22 x 10 x 9
TRX 200 (84)		25 x 12 x 9
TRX 200 (90-93, 96-97)	21 x 7 x 10	22 x 10 x 8
TRX 200SX (86-88)		22 x 11 x 8
ATC 250 Big Red (85)		25 x 12x 9
ATC 250SX (85-87)		22 x 11 x 8
ATC 250R (81-84)		22 x 11 x 8
ATC 250R (85-86)		20 x 10 x 9
TAX 250 Big Red (85-87)	21 x 7 x 10	25 x 12 x 9
TRX 250R (86-89)	22 x 7 x 10	20 x 10 x 9
TRX 250 Recon (97-07)	22 x 7 x 11	22 x 10 x 9
TRX 250EX (00-07)	22 x 7 x 10	22 x 10 x 9
TRX 250X (86-92)	22 x 7 x 10	20 x 10 x 9
TRX 300 2WD (88-00)	23 x 8 x 11	25 x 12 x 9
TRX 300 4WD (88-00)	23 x 8 x 11	24 x 9 x 11
TRX 300ES (93-05)	22 x 7 x 10	20 x 10 x 9
TRX 300EX (93-07)	22 x 7 x 10	20 x 10 x 9
ATC 350X (85-86)		22 x 11 x 9
TRX 350 4WD (86-92)	24 x 9 x 11	24 x 9 x 11
TRX 350 Rancher S-ES 2WD (00-06)	24 x 8 - 12	25 x 11 - 10
TRX 350 Rancher S-ES 4WD (00-06)	24 x 8 - 12	24 x 9 - 11
TRX 400EX (99-07)	22 x 7 x 10	20 x 10 x 9
TRX 400 Rancher AT (04-06)	24 x 8 - 12	24 x 10 - 11
TRX 400 Foreman (96-06)	24 x 8 x 11	24 x 10 x 11
TRX 420 (07-10)	24 x 8 x 12	24 x 10 x 11
TRX 450 Foreman S-ES (98-04)	25 x 8 x 12	25 x 10 x 12
TRX 450R (04-07)	22 x 7 - 10	20 x 10 - 9
TRX 500 Foreman S-ES (05-07)	25 x 8 x 12	25 x 10 x 12
TRX 500 Rubicon (01-07)	25 x 8 x 12	25 x 10 x 12
TRX 650 Rincon (03-07)	25 x 8 x 12	25 x 10 x 12
TRX 700 Rincon (06-07)	25 x 8 x 12	25 x 10 x 12

Kawasaki

Model	Front Tyre	Rear Tyre
KLT 110/160/185/200 (All)		21 x 9 x 8
KLF 185 Bayou (85-87)		22 x 11 x 8
KLF 220 Bayou (88-02)	22 x 8 x 9	22 x 10 x 10
KLT250 (82-85)		25 x 12 x 9
KXT 250 Tecate (84-87)		22 x 11 x 10
KXT 250 Tecate-4 (87-88)	21 x 7 x 10	22 x 11 x 10
KSF 250 Mojave (87-06)	21 x 7 x 10	22 x 11 x 10
KLF 300 Bayou (85-05)	22 x 9 x 10	24 x 11 x 10
KLF 300B Lakota (95-00)	22 x 8 x 10	22 x 11 x 10
KLF 300 Bayou (85-05)	22 x 9 x 10	24 x 11 x 10
KLF300 Bayou (89-05)	24 x 8 x 11	24 x 10 x 11
Prairie 300 (99-05)	25 x 8 x 12	25 x 11 x 10
Prairie 360 (03-06)	25 x 8 x 12	25 x 10 - 12
KLF 400 Bayou (93-05)	24 x 8 x 11	24 x 10 x 11
Prairie 400 (97-05)	25 x 8 x 12	25 x 12 x 10
KXF 400 (03-05)	22 x 7 x 10	20 x 10 - 9
Mule 500	22 x 9 x 10	22 x 11 x 10
Mule 600	22 x 9 x 10	22 x 11 x 10
Brute Force 650 (03-07)	25 x 8 - 12	25 x 10 - 12
Brute Force 650i (06-07)	25 x 8 - 12	25 x 10 - 12
Prairie 650/700 (02-06)	25 x 8 - 12	25 x 10 - 12
KXF 700 (03-07)	22 x 7 - 10	22 x 11 - 10
Brute Force 750i (05-07)	25 x 8 x 12	25 x 10 - 12
Mule 1000/2500	22 x 11 x 10	22 x 11 x 10
Mule 3000	23 x 11 - 10	23 x 11 - 10

Kymco

Model	Front Tyre	Rear Tyre
MXER 50	20 x 7 - 8	22 x 10 - 8
MXU 50	20 x 7 - 8	22 x 10 x 10
MXER 150	20 x 7 - 8	22 x 10 - 8
Maxxer 300	21 x 7 - 10	20 x 11 - 9
MXU 300	22 x 7 - 10	22 x 10 - 10
MXU 500	25 x 8 - 12	25 x 10 - 12

TYRE FITMENT CHART



Polaris

Model	Front Tyre	Rear Tyre
Trail Boss/Cyclone/Trail Blazer (86-02)	23 x 7 x 10	22 x 11 x 10
Trail Boss 250/300 (87-95)	23 x 7 x 10	22 x 11 x 10
Xplorer 300/Trail Boss 350L/400L (90-99)	23 x 7 x 10	24 x 11 x 10
Magnum 325 (00-06)	24 x 8 x 12	24 x 11 x 10
Xpedition 325 (00-06)	24 x 8 x 12	24 x 11 x 10
Sportsman 335 (99-07)	23 x 7 x 10	24 x 11 x 10
Trail Boss 350L/400L (90-94)	25 x 8 x 12	25 x 12 x 10
Sportsman 400/Magnum 425L (95-98)	25 x 8 x 12	25 x 11 x 10
Sportsman 400/Magnum 425L (01-07)	25 x 8 - 12	25 x 11 - 10
Magnum/Xpress 300/400L (96-99)	23 x 7 x 10	24 x 11 x 10
Xplorer 400L (95-03)	25 x 8 x 12	25 x 12 x 10
Scrambler 400L (95-07)	23 x 7 x 10	22 x 11 x 10
Sport 400L (94-99)	23 x 7 x 10	22 x 11 x 10
Xpedition 425 (99-06)	25 x 8 x 12	25 x 11 x 10
Xplorer/Sportsman 500 (96-06)	25 x 8 x 12	25 x 11 x 10
Magnum 500 (99-05)	25 x 8 x 12	25 x 11 x 10
Scrambler 500 (97-06)	23 x 7 x 10	22 x 11 x 10
Predator 500 (03-06)	21 x 7 - 10	20 x 11 - 10
Sportsman 600 (03-07)	25 x 8 - 12	25 x 11 - 12
Sportsman 700 (02-07)	25 x 8 - 12	25 x 10 - 12
Sportsman 800 (05-07)	26 x 8 - 12	26 x 10 - 12
Diesel (99-06)	25 x 8 x 12	25 x 11 x 10
Big Boss (89-94)	22 x 8 x 10	22 x 11 x 10
Magnum/Big Boss (93-06)	25 x 8 x 12	25 x 12 x 10
Ranger	25 x 10 x 12	25 x 11 x 10
Ranger	25 x 10 x 12	25 x 11 - 12

Suzuki

Model	Front Tyre	Rear Tyre
LT 50 (86-87)	145/70 - 60	145/70 - 60
LT 80 QuadSport (87-05)	19 x 7 x 8	19 x 7 x 8
LT/ALT 125 (83)		22 x 11 x 8
LT/ALT 125F (84-87)		22 x 11 x 8
LT 160 Quadrunner (89-02)	20 x 7 x 8	22 x 10 x 8
LT 185 Quadrunner (83)		22 x 11 x 8
LT/ALT 185 (84-87)		22 x 11 x 8

Suzuki

Model	Front Tyre	Rear Tyre
LT 230 EH/EJ/EK (87-89, 91-93)	21 x 7 x 10	22 x 11 x 9
LT 230EH/EJ/EK Quadrunner (87)		22 x 11 x 9
LT 230 GEG Quadrunner (85-86)		22 x 11 x 8
LT 230 GEF Quadrunner (85-87)		22 x 11 x 9
LT 230 QuadSport (85-88)	21 x 7 x 10	22 x 11 x 9
LT 250 (88-02)	22 x 8 x 10	24 x 11 x 10
LT 250E/F/G Quadrunner (84-86)		22 x 11 x 9
LT 250 QuadSport (89-90)	21 x 7 x 10	22 x 11 x 9
LT 250F Quadrunner (89-02)	22 x 8 x 10	24 x 11 x 10
LT 250R QuadRacer (85-92)	21 x 7 x 10	
LT 250R QuadRacer (85-86)		22 x 11 x 10
LT 250R QuadRacer (87-92)		22 x 10 x 10
Z250 (02-07)	22 x 7 - 10	20 x 10 - 9
OZARK 250 (02-07)	22 x 7 - 11	20 x 10 - 9
LT 300 XM King Quad (91-03)	24 x 8 x 11	25 x 10 x 12
LT 300 E Quadrunner (87-90)	21 x 8 x 9	
LT 300 EH Quadrunner (87-88)		25 x 12 x 9
LT 300 EJ Quadrunner (89-90)		25 x 12 x 9
LT 300 XM King Quad (91-03)	24 x 8 x 11	25 x 10 x 12
Eiger 400 (02-07)	25 x 8 - 12	25 x 10 x 12
Eiger 400 Auto (02-07)	25 x 8 - 12	25 x 10 x 12
Z400 (02-07)	22 x 7 - 10	20 x 10 - 9
King Quad 450 (07)	25 x 8 x 12	25 x 10 x 12
LTR-450 (06-07)	20 x 6 - 10	18 x 10 - 8
LT 500R QuadRacer (87-90)	21 x 7 x 10	22 x 11 x 10
LT-F/LT-A 500 Quadrunner (98-02)	25 x 8 x 12	25 x 10 x 12
Vinson 500 (02-06)	25 x 8 x 12	25 x 10 x 12
Twin Peaks 700 (04-06)	25 x 8 x 12	25 x 10 x 12
King Quad 700 (06-07)	25 x 8 x 12	25 x 10 x 12

Yamaha

Model	Front Tyre	Rear Tyre
YF 60 Zinger (All)		15 x 7 x 6
YFM 80E Badger (93-04)		20 x 9 x 8
YFM 80 Moto-4 (87-92)		19 x 8 x 7
YFM 100T Moto-4 (87-90)		20 x 9 x 8



TYRE FITMENT CHART



Yamaha

Model	Front Tyre	Rear Tyre
YFA 125 Breeze (89-04)	20 x 7 x 8	22 x 10 x 8
YT 125/175 Tri-Moto (81-85)		22 x 11 x 8
YTM 200E/L/R Tri-Moto (83, 86)		25 x 12 x 9
YTM 200 DX (88-90)	22 x 8 x 10	22 x 11 x 8
YSF 200 Blaster (88-07)	21 x 7 x 10	21 x 10 x 8
YFM 225 Moto-4 (85-87)	22 x 8 x 10	25 x 12 x 9
YTM 225 DX/DR Tri-Moto		22 x 11 x 8
YFM 250 Moto-4 (89)	22 x 8 x 10	25 x 12 x 9
YFB 250 Timberwolf (92-98)	22 x 7 x 10	22 x 11 x 10
YFB 250 Timberwolf (95-05)	23 x 8 x 10	23 x 10 x 10
YTZ 250 Tri-Z (85)		22 x 11 x 8
YTZ 250 Tri-Z (86)		22 x 11 x 9
Bear Tracker 250 (99-05)	22 x 7 x 10	22 x 10 x 10
Bruin 250 (05)	22 x 7 x 10	22 x 10 x 10
YFM 350 XT Warrior (87-05)	22 x 7 x 10	22 x 10 x 9
YFZ 350T Banshee (87-88, 91-06)	21 x 7 x 10	22 x 10 x 9
YFZ 350T Banshee (89-90)	21 x 7 x 10	22 x 11 x 10
YFM 350 ER Moto-4 (87-95)	22 x 8 x 10	25 x 12 x 9
YFM 350 Big Bear (96-99)	25 x 8 x 12	25 x 12 x 9
YFM 350 Big Bear (00-05)	25 x 8 x 12	23 x 10 x 10
YFM 350/400 Big Bear (87-06)	25 x 8 x 12	25 x 10 x 12
YFM 350 Bruin (04-06)	25 x 8 x 12	25 x 10 x 12
YFM 350 Raptor (04-07)	22 x 7 x 10	22 x 10 x 9
YFM 350/450 Wolverine (95-07)	23 x 8 x 12	23 x 10 x 12
YFM 400 Kodiak (93-04)	25 x 8 x 12	25 x 10 x 12
YFM 400/450 Kodiak (93-04)	25 x 8 x 12	25 x 10 x 12
YFM 400/450 Kodiak (05-06)	25 x 8 x 12	25 x 10 x 12
YFZ 450 (04-06)	21 x 7 - 10	20 x 10 - 9
YFM 600 Grizzly (98)	25 x 8 x 12	25 x 10 x 10
YFM 600 Grizzly (99-00)	25 x 8 x 12	25 x 10 x 12
YFM 600 Grizzly (01)	25 x 8 x 12	25 x 10 x 10
YFM 660/700R Raptor (01-07)	21 x 7 x 10	20 x 10 x 9
YFM 660 Grizzly (02-07)	25 x 8 - 12	25 x 10 - 12
YFM 450/660 Rhino (04-07)	25 x 8 - 12	25 x 10 - 12
YFM 700 Grizzly (07)	25 x 8 - 12	25 x 10 - 12

TUBES



ATV Tubes

ATV City Part No.	Size
410.0010	145 / 70x6 TR87
410.0020	22 x11 x 8 TR13
410.0030	22 x 12.5 x 9 / 25 x 12 x 9 TR13
410.0040	21 x 7 x 10 / 22 x 8 x 10 TR13
410.0050	22 x 11 x 10 / 24 x 11 x 10 TR13
410.0060	23 x 8 x 11 TR13
410.0070	24 x 8 x 11 TR13
410.0080	24 x 9 x 11 TR13
410.0090	24 x 10 x 11 TR13
410.0100	24 x 8 x 12 TR13
410.0110	25 x 8 x 12 TR13
410.0120	25 x 10 x 12 TR13

VALVES



Tyre Valves

ATV City Part No.	Size
120.0055	Tyre Valve Stem 42mm TR413
120.0057	Tyre Valve Stem 35mm TR412
120.0053	Tyre Valve Core Short Packet of 100 pieces
120.0058	Tyre Valve Cap Packet of 100 pieces

Valve core removal tool

ATV City Part No.	Description
285.0045	2 X tyre valve core removal tools 90mm and 150mm. Orange in colour easy to see tools.

PUNCTURE REPAIR KITS



DIY puncture repair kit

ATV City Part No.	Description
120.0060	No need to take the tyre off the rim anymore. Comes with all the tools and enough strings for 7 punctures



Replacement strings

ATV City Part No.	Description
120.0065	Replacement puncture repair strings 50 per box



Tyre Puncture preventer

ATV City Part No.	Description
120.0250	Tyre Puncture Preventer 473cc bottle

HUB & STUB WHEEL KITS



Hub & Stub Wheel Kit

ATV City Part No.	Description
415.0005	Wheel hub & stub kit 1 kit = 1 x (22 x 11 x 8) tyre, rim 100 PCD, 1 x hub stub kit with 35mm square shaft
415.0010	22 x 11 x 8 tyre/rim assembly
415.0015	50mm tow hitch
415.0020	Hub stub kit with 35mm square shaft (for 1 side)



TYRE FITTING EQUIPMENT



Tyre Bead Sealer

ATV City Part No.	Description
120.0275	Tyre Bead Sealer - 1 litre



Tyre Mounting Paste

ATV City Part No.	Description
120.0285	Tyre Mounting Paste - 5kg

Miscellaneous

Filters

Seat Covers

Tools

Tyres

Engine Parts

Sprayers





the best part of your atv

- 1: BEARINGS, BUSH KITS, BALLJOINTS
- 2: BRAKING
- 3: BULLBARS, MUDFLAP KITS
- 4: CABLES
- 5: CARBURETTOR PARTS
- 6: DRIVE LINE / CVT BELTS / AXLES
- 7: ELECTRICAL
- 8: EXHAUSTS
- 9: MISCELLANEOUS
- 10: FILTERS
- 11: SEAT COVERS, OVER COVERS
- 12: TOOLS
- 13: TYRES / TUBES / RIMS
- 14: ENGINE COMPONENTS
- 15: SPRAYERS & SPRAYER ACCESSORIES



14: ENGINE COMPONENTS

CAM CHAINS



Honda



ATV City Part No.	Size	Model
205.Y82RH110	SCA0409X110	TRX250X 87-92
205.Y82RH110	SCA0409X110	TRX300FW 88-00
205.Y82RH110	SCA0409X110	TRX300EX 93-06
205.Y82RH52	SCA0409X52L	TRX350 Rancher 00-06

Kawasaki



ATV City Part No.	Size	Model
205.Y82RH106	SCA0409X106	KLF220 88-02
205.Y82RH106	SCA0409X106	KLF250 03-06
205.Y05T90	05TX90L	KLF300 86-09
205.Y05T90	05TX90L	KEF300 Lakota 95-03
205.Y05T90	05TX90L	KVF300 PRAIRIE 99-02
205.Y82RH118	82RH 2010X118	KLF400B
205.Y82RH118	82RH 2010X118	KVF400 Prairie

Suzuki



ATV City Part No.	Size	Model
205.Y25H104	25H X 104	LT250S 89-90
205.Y25H104	25H X 104	LTF250 Quad Runner 87-08
205.Y25H104	25H X 104	LTF250 OZARK
205.Y25H104	25H X 104	LTF 4WD QuadRunner 87-98

Yamaha



ATV City Part No.	Size	Model
205.Y25H92	25H X 92L	YFA1 Breeze 89-00
205.Y25H104	25H X 104L	YTM200/225 83-86
205.Y25H104	25H X 104L	YFM 225/250 Moto-4 86-91
205.Y25H104	25H X 104L	YFB250 Timerwolf 92-00
205.Y25H104	25H X 104L	YFM250 Bear Tracker
205.Y219H90	219T X 90L	YFM350ER Moto-4 87-95
205.Y219H90	219T X 90L	YFM350FW BigBear 87-99
205.Y219H90	219T X 90L	YFM350 X Warrior
205.Y219H90	219T X 90L	YFM350FX Wolverine 95-00
205.Y219H90	219T X 90L	YFU-1 Pro Hauler 89
205.Y219H90	219T X 90L	YFM400FW KODIAK 93-99
205.Y219H90	219T X 90L	YFM400FW Big Bear 00-06



GASKET SETS



Honda

Model	Year	Complete set No.	Top set No.
TRX250 Recon	97-01	180.19HA1841	180.19HA1843
TRX250TE/TM Fourtrax Recon ES	02-11	180.19HA2001	180.19HA2003
TRX300 Big Red / Fourtrax	88-98	180.19HA1251	180.19HA1253
TRX300 Big Red / Fourtrax	99-00	180.19HA1911	180.19HA1253
TRX350FE / FM / TE / TM Fourtrax Rancher	00-06	180.19HA2081	180.19HA9023
TRX350 Fourtrax Rancher - Rocker Cover Gasket 12315-HN5-671			180.19HA9023R
TRX400FW Foreman	95-01	180.19HA1881	180.19HA1883
TRX420FA / FPA Fourtrax Rancher AT	09-11	180.19HA2381	180.19HA2383
TRX420FE / FM / TE / TM Fourtrax Rancher	07-08	-	180.19HA2323
TRX420FM / FE / TE / TM / FP Fourtrax Rancher	09-10	180.19HA2351	180.19HA2353
TRX450ES / FE / FM / S Fourtrax Foreman	98-04	180.19HA1931	180.19HA1933
TRX450 Foreman - Rocker Cover Gasket 12315-HM7-005	98-04		180.19HA1933R
TRX500FA / FPA Fourtrax Foreman Rubicon	01-11	180.19HA2091	180.19HA2093
TRX500FE / FM / FPM/E Fourtrax Foreman	05-11	180.19HA2211	180.19HA2213
TRX650FA Fourtrax Rincon	03-05	180.19HA2231	-

Kawasaki

Model	Year	Complete set No.	Top set No.
KLF220 Bayou	88-02	180.19KA0281	180.19KA0283
KLF250 Bayou	03-11	180.19KA0811	180.19KA0813
KLF300B Bayou	88-04	180.19KA0291	180.19KA0293
KLF300C Bayou	89-05	180.19KA0301	180.19KA0293
KVF360 Prairie	03-11	180.19KA0831	180.19KA0833
KLF400 Bayou	93-99	180.19KA0561	180.19KA0563
KVF650 Prairie / Brute Force	02-11	180.19KA0801	180.19KA0803
KVF750	05-07		180.19KA9023



Miscellaneous

Filters

Seat Covers

Tools

Tyres

Engine Parts

Sprayers

GASKET SETS



Suzuki

Model	Year	Complete set No.	Top set No.
LT50 Quadrunner	84-92	180.19SA921	180.19SA923
LT-A50 Quad Master	02-05	180.19SA1311	180.19SA1313
LT80 Quad Sport	95-06	180.19SA1061	180.19SA1063
LT-F250 Ozark	02-09	180.19SA1361	180.19SA1363
LT-Z250 QuadSport	04-09	180.19SA1361	180.19SA1363
LT-A400 Eiger	02-07	180.19SA1371	180.19SA1373
LT-A400F King Quad	08-11	180.19SA1581	180.19SA1583
LT-F400 Eiger	02-07	180.19SA1381	180.19SA1383

Yamaha



Model	Year	Complete set No.	Top set No.
YFA1 Breeze	89-01	180.19YA1101	180.19YA1103
YFB250 Timberwolf	92-96	180.19YA1051	180.19YA1053
YFB250 Timberwolf	97	-	180.19YA1283
YFB250FW Timberwolf	94-96	180.19YA1051	180.19YA1053
YFB250FW Timberwolf	97-98	-	180.19YA1283
YFB250FW Timberwolf	99-00	180.19YA1421	180.19YA1283
YFB250U Timberwolf	96	180.19YA1051	180.19YA1053
YFB250U Timberwolf	97-98	-	180.19YA1283
YFM250X Bear Tracker	99-04	180.19YA1421	180.19YA1283
YFM350ER Moto-4	93-95	180.19YA1071	180.19YA1073
YFM350FW / U Big Bear	92-98	180.19YA1071	180.19YA1073
YFM350A / FA Bruin Auto	04-06	180.19YA1461	180.19YA1463
YFM350FG Grizzly	07-10	180.19YA1461	180.19YA1463
YFM350FGI Grizzly	07-10	180.19YA1461	180.19YA1463
YFM350X Wolverine	08-09	180.19YA1461	180.19YA1463
YFM400F / FH / FW Big Bear	00-02	180.19YA1391	180.19YA1073
YFM400FW Kodiak	93-98	180.19YA1071	180.19YA1073
YFM400FWN Big Bear 4WD	00-06	180.19YA1391	180.19YA1073
YFM400FB Big Bear IRS	07-09	180.19YA1391	180.19YA1073
YFM400FB Big Bear 4WD	10	180.19YA1391	180.19YA1073
YFM600FWA Grizzly	98-01	180.19YA1361	180.19YA1363
YFM660 Grizzly	98-01		180.19YA9033
YXR660 Rhino	04-07	180.19YAR8651	180.19YAR8653
YFM660 GRIZZLY	02-08	180.19YAR8651	180.19YAR8653
YFM700 GRIZZLY	07-12	180.19YAR9411	
YXR700 RHINO	08-10	180.19YAR9411	

PISTON KITS

High quality replacement piston kits properly meet O.E.M specifications. Kit includes piston, ring set, wrist pin and circlips.



Honda

Model	Year	STD	0.25	0.5	0.75	1	1.25	1.5	2
TRX250	97-01	190.10025	190.10025-1	190.10025-2	190.10025-3	190.10025-4			
TRX250	02-14	190.10026	190.10026-1	190.10026-2	190.10026-3	190.10026-4			
TRX250EX	01-07	190.10026	190.10026-1	190.10026-2	190.10026-3	190.10026-4			
TRX300/FW	88-00			190.10002-2		190.10002-4		190.10002-6	
TRX350	00-06	190.10007	190.10007-1	190.10007-2	190.10007-3	190.10007-4			
TRX400FW	95-03	190.10001	190.10001-1	190.10001-2	190.10001-3	190.10001-4			
TRX420 RANCHER	07-14	190.10042	190.10042-1	190.10042-2	190.10042-3	190.10042-4	190.10042-5	190.10042-6	190.10042-7
TRX450ES/S	98-04	190.10000	190.10000-1	190.10000-2	190.10000-3	190.10000-4		190.10000-6	
TRX500 FOREMAN	05-11	190.10008	190.10008-1	190.10008-2	190.10008-3	190.10008-4		190.10008-6	
TRX650 RINCON	03-05	190.10009							

Kawasaki

Model	Year	STD	0.25	0.5	0.75	1	1.5
KLF220	88-02	190.20001	190.20001-1	190.20001-2		190.20001-4	190.20001-6
KLF250	03-10	190.04121	190.04122	190.04123	190.04124	190.04125	
KEF300	95-03	190.20000	190.20000-1	190.20000-2		190.20000-4	190.20000-6
KLF300/4X4	85-04	190.20000	190.20000-1	190.20000-2		190.20000-4	190.20000-6
KVF300/4X4	99-02	190.20000	190.20000-1	190.20000-2		190.20000-4	190.20000-6
KVF360/4X4	03-10	190.04131	190.04132	190.04133	190.04134	190.04135	

Suzuki

Model	Year	STD	0.25	0.5	0.75	1
LT230E/GE	85-93			190.30000-2		190.30000-4
LT-F230	86-87			190.30000-2		190.30000-4
LT4WD	87-96			190.30000-2		190.30000-4
LT-F250	88-09			190.30000-2		190.30000-4
LT-Z250	04-09			190.30000-2		190.30000-4
LT-F4WD	97-98			190.30000-2		190.30000-4
LT-F300F	99-02			190.30001-2		190.30001-4
LT-F4WDX	91-98			190.30001-2		190.30001-4
LT-A400/F	02-12	190.30010	190.30010-1	190.30010-2	190.30010-3	190.30010-4
LT-F400/F	02-12	190.30010	190.30010-1	190.30010-2	190.30010-3	190.30010-4

PISTON KITS

High quality replacement piston kits properly meet O.E.M specifications. Kit includes piston, ring set, wrist pin and circlips.



Yamaha

Model	Year	STD	0.25	0.5	0.75	1	1.5
YFB250/F/U	92-00	190.04301	190.04302	190.04303	190.04304	190.04305	
YFM250	89-91	190.04301	190.04302	190.04303	190.04304	190.04305	
YFM250B	05-09	190.04301	190.04302	190.04303	190.04304	190.04305	
YFM250X	99-04	190.04301	190.04302	190.04303	190.04304	190.04305	
YFM350/ER/U	87-00	190.40005		190.40005-2		190.40005-4	190.40005-6
YFM350F/FW	87-99	190.40005		190.40005-2		190.40005-4	190.40005-6
YFM350FX/X	87-09	190.40005		190.40005-2		190.40005-4	190.40005-6
YFM350G	07-10	190.40005		190.40005-2		190.40005-4	190.40005-6
YFM350R	04-09	190.40005		190.40005-2		190.40005-4	190.40005-6
YFM400F/FW	93-06		190.40006-1	190.40006-2	190.04324	190.40006-4	190.40006-6
YFM400FB	07-11		190.40006-1	190.40006-2	190.04324	190.40006-4	190.40006-6
YFM400A/FA	00-06	190.40008		190.40008-2		190.40008-4	
YFM400FG	07-08	190.40008		190.40008-2		190.40008-4	
YFM450FA	03-06	190.04391	190.04392	190.04393	190.04394	190.04395	
YFM450FG	07-14	190.04391	190.04392	190.04393	190.04394	190.04395	
YFM450FX	06-10	190.04391	190.04392	190.04393	190.04394	190.04395	
YXR450F	06-09	190.04391	190.04392	190.04393	190.04394	190.04395	
YFM600	98-01	190.40007		190.40007-2		190.40007-4	
YFM660FWA	02-08	190.40004		190.40004-2		190.40004-4	190.40004-6
YFM660R	01-05	190.40004		190.40004-2		190.40004-4	190.40004-6
YXR660F	04-07	190.40004		190.40004-2		190.40004-4	190.40004-6



PISTON RINGS KITS

Replacement piston ring sets to fit O.E.M pistons.
Made by O.E. manufactures in Japan.



Honda

Model	Year	STD	0.25	0.5	0.75	1
TRX300/FW	88-00	192.04531	192.04532	192.04533	192.04534	192.04535
TRX250	97-14	192.04561	192.04562	192.04563	192.04564	192.04565
TRX250EX	01-08	192.04561	192.04562	192.04563	192.04564	192.04565
TRX350	00-06	192.04571	192.04572	192.04573	192.04574	192.04575
TRX400FW	95-03	192.04501	192.04502	192.04503	192.04504	192.04505
TRX420 RANCHER	07-14	192.045H1	192.045H2	192.045H3	192.045H4	192.045H5
TRX450ES/S	98-04	192.04541	192.04542	192.04543	192.04544	192.04545
TRX500FE/FM FOREMAN	05-14	192.045G1	192.045G2	192.045G3	192.045G4	192.045G5

Kawasaki

Model	Year	STD	0.25	0.5	0.75	1
KEF300	95-03	192.04611	192.04612	192.04613	192.04614	192.04615
KLF300/4X4	85-04	192.04611	192.04612	192.04613	192.04614	192.04615
KVF300/4X4	99-02	192.04611	192.04612	192.04613	192.04614	192.04615
KVF360/4X4	03-12	192.04631	192.04632	192.04633	192.04634	192.04645

Suzuki

Model	Year	STD	0.25	0.5	0.75	1
LT230E/GE	85-93		192.04702	192.04703	192.04704	
LT-F230	86-87		192.04702	192.04703	192.04704	
LT4WD	87-96		192.04702	192.04703	192.04704	
LT-250	88-09		192.04702	192.04703	192.04704	
LT-Z250	04-09		192.04702	192.04703	192.04704	
LT-F4WD	97-98		192.04702	192.04703	192.04704	
LT-A400/F	02-12	192.04721	192.04722	192.04723	192.04724	192.04725
LT-F400/F	02-12	192.04721	192.04722	192.04723	192.04724	192.04725

PISTON RINGS KITS

Replacement piston ring sets to fit O.E.M pistons.
Made by O.E. manufactures in Japan.



Yamaha

Model	Year	STD	0.25	0.5	0.75	1
YFB250/F/U	92-00	192.04801	192.04802	192.04803	192.04804	192.04805
YFM250	89-91	192.04801	192.04802	192.04803	192.04804	192.04805
YFM250B	05-09	192.04801	192.04802	192.04803	192.04804	192.04805
YFM250X	99-04	192.04801	192.04802	192.04803	192.04804	192.04805
YFM350ER/U	87-00	192.04811	192.04812	192.04813	192.04814	192.04815
YFM350F/FW	87-99	192.04811	192.04812	192.04813	192.04814	192.04815
YFM350FX/X	87-09	192.04811	192.04812	192.04813	192.04814	192.04815
YFM350G	07-10	192.04811	192.04812	192.04813	192.04814	192.04815
YFM350R	04-09	192.04811	192.04812	192.04813	192.04814	192.04815
YFM400F/FW	93-06	192.04811	192.04812	192.04813	192.04814	192.04815
YFM400FB	07-11	192.04811	192.04812	192.04813	192.04814	192.04815
YFM450FA	03-06	192.04891	192.04892	192.04893	192.04894	192.04895
YFM450FG	07-14	192.04891	192.04892	192.04893	192.04894	192.04895
YFM450FX	06-10	192.04891	192.04892	192.04893	192.04894	192.04895
YXR450F	06-09	192.04891	192.04892	192.04893	192.04894	192.04895

Conrod Kit



ATV City Part No.	Model
183.0050	TRX350 FE/FM/TE/TM 00-06



the best part of your atv

- 1: BEARINGS, BUSH KITS, BALLJOINTS
- 2: BRAKING
- 3: BULLBARS, MUDFLAP KITS
- 4: CABLES
- 5: CARBURETTOR PARTS
- 6: DRIVE LINE / CVT BELTS / AXLES
- 7: ELECTRICAL
- 8: EXHAUSTS
- 9: MISCELLANEOUS
- 10: FILTERS
- 11: SEAT COVERS, OVER COVERS
- 12: TOOLS
- 13: TYRES / TUBES / RIMS
- 14: ENGINE COMPONENTS
- 15: SPRAYERS & SPRAYER ACCESSORIES



15: SPRAYERS & SPRAYER ACCESSORIES

Economy Spot Sprayers



LG-15-EC

- 15 gallon (57 litre) corrosion resistant poly tank
- 12 volt diaphragm high-flo pump, 1.0 GPM (3.8 LPM), 35 PSI
- Full drain out capability with moulded-in drain port, cap and tether
- 5" fill lid with tether
- Larger hose wrap, horns for hose storage
- Both gallon and litre fluid volume indicator on tank
- Moulded wand clamps
- 18" lever hand gun with adjustable patterned tip
- 15' (4.5m) hand gun hose
- Max horizontal throw - 30'
- Max vertical throw - 18'
- Ready for Round-up
- ATV City P/n 350.5301302



LG-14-PM / LG-25-PM

- 15 gallon (57 litre) corrosion resistant poly tank (LG-14-PM)
- 25 gallon (94.6 litre) corrosion resistant poly tank (LG-25-PM)
- 12 volt diaphragm high-flo pump, 2.1 GPM (7.9 LPM), 35 PSI
- Full drain out capability with moulded-in drain port, cap and tether
- 5" fill lid with tether
- Larger hose wrap, horns for hose storage
- Both gallon and litre fluid volume indicator on tank
- Moulded wand clamps
- 18" lever hand gun with adjustable patterned tip
- 15' (4.5m) hand gun hose-
- Max horizontal throw - 30'
- Max vertical throw - 18'
- Ready for Round-up
- ATV City P/n 350.5301144 (LG-14-PM)
- ATV City P/n 350.5301146 (LG-25-PM)

LG-25-PM is not recommended for use with ATVs



Economy Spot Sprayers



LG-25-HV

- 25 Gallon Corrosion Resistant Polyethylene Tank
- Full Drain Out Capability With Moulded In Drain Port, Cap & Tether
- Full Length Drain Sump
- 5" Fill Lid With Tether
- Both Gallon And Litre Fluid Volume Indicator
- Moulded Wand Clips
- 12 Volt (Demand) Diaphragm
- 3.8 G.P.M. Pump
- 45 P.S.I.
- Deluxe Pistol Grip Handgun With Adjustable Pattern Tip
- Max. Horizontal Throw - 35 Ft.; Max Vertical Throw - 26 Ft.
- 15 Ft. Handgun Hose
- Ready For Roundup®
- ATV City P/n 350.5301222



LG-40-SS

- 40 gallon (150 litre) corrosion resistant poly tank
- 12 volt diaphragm high-flo pump, 3.8 GPM (14.38 LPM), 45 PSI
- Fully drainable sump
- 8' wire harness with clips and on/off switch
- 5" fill lid with tether
- Poly clips for hand gun storage
- deluxe hand gun with adjustable patterned tip
- 25' (7.6m) hand gun hose
- Max horizontal throw - 43'
- Max vertical throw - 26'
- Ready for Round-up
- ATV City P/n 350.5301335



LG-55-3PT

- 55 gallon (208 litre) corrosion resistant poly tank
- Breakaway hinges on boom
- 7 nozzle boom - 140" (3.5m) spray coverage
- Breakaway, fold behind 3 section boom
- Single manual lever valve boom control (on/off)
- Relief valve
- Pressure gauge
- Equipped with pump kit to fit most roller pumps (pump not included)
- 3 point linkage frame
- Max horizontal throw 48' (14.63m)
- Max vertical throw 33' (10m)
- ATV City P/n 350.5300576
- Roller Pump Assembly P/n 350.5271707

Spreaders



ATV-DMS-12V

- 2.2 Cubic Foot Poly Hopper
- 12 Volt Motor With Variable Speed Control (VSC-10) & On/Off Switch
- Stainless Steel Radial 6-Blade Fan
- Holds Up To 145 Lbs Of Potash Or 99 Lbs of Urea
- ATV City P/n 350.5301845

Booms



ATV-BK-200 SOLID BOOM

- 2 nozzle solid boom
- 80" (2m) coverage
- Suitable for all tanks
- ATV City P/n 350.5301230



ATV-BK-3025

- 3-Nozzle Boom
- 30 Foot Spray Coverage
- Minimum Pump Requirement - 3.8 G.P.M.
- DOES NOT INCLUDE TANK & PUMP
- ATV City P/n 350.5301484

Booms



ATV-BK-500 FOLDING BOOM

- 5 nozzle solid boom folding behind
- 100" (2.5m) coverage
- Suitable for use with LG-14-PM/LG-25-EC
- ATV City P/n 350.5301231



ATV-BK-700

- 7-Nozzle Boom
- 140" Spray Coverage
- Minimum Pump Requirement 2.1 G.P.M.
- AIXR SPRAY TIP
- DOES NOT INCLUDE TANK & PUMP
- ATV City P/n 350.5301232



ATV-BK-710

- 7-Nozzle Boom
- 140" Spray Coverage
- Minimum Pump Requirement - 3.8 G.P.M.
- AIXR SPRAY TIP
- DOES NOT INCLUDE TANK & PUMP
- ATV City P/n 350.5301271

Wireless Remote



7771938

- Controls ALL 12v Products up to 20 amps
- Range: 250 feet
- Convenient Keychain Clip

PARTS MANUALS

LG-15-EC

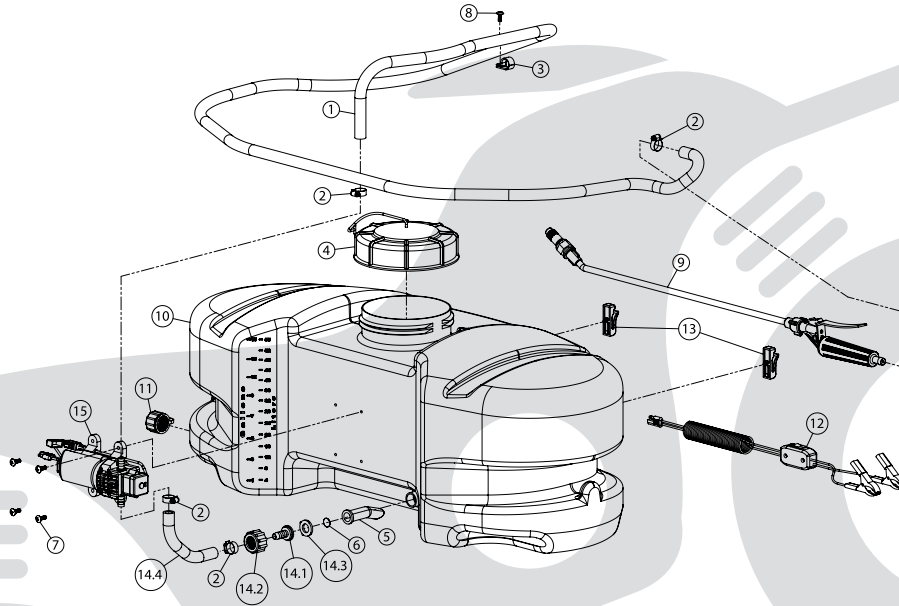

Item	Part No.	Qty	Description
1	5020215	1	Hose, 3/8"-1 Brd. x 15 Ft.
2	5051114	4	Hose Clamp, 3/8"
3	5051122	1	5/8" Black Nylon Loom Cable Clamp
4	5058188	1	Tank Lid w/Lanyard
5	5100452	1	Siphon Tube
6	5116437	1	Strainer, 1" Cone Filter (No Gasket)
7	5117167	4	#10-24 x 5/8" Phillips Truss Head Machine Screw
8	5117234	1	#10-24 x 1/2" Phillips Truss Head Machine Screw
9	5163100	1	Low-Flow Handgun w/X-26 Tip
10	5169242	1	15 Gallon (New Style) Tank

Item	Part No.	Qty	Description
11	5274373	1	Drain Plug Cap, Tether, and Washer Assembly
12	5274443	1	Lead Wire Assembly (w/Switch), 96"
13	5274880	1	Pkg. (2) Handgun Clips Et (2) Screws
14	5275511	1	Inlet Sub-Assembly (EC Units)
14.1	5149034	1	Poly Swivel, 3/8" Hose Barb
14.2	5006209	1	Poly Knurled Swivel Nut, 3/4" FGHT
14.3	5016066	1	Garden Hose Washer
14.4	5020095	1	Hose, 3/8"-1 Brd. x 6 1/2"
15	5275702	1	Gold Series 1.0 g.p.m. Pump

PARTS MANUALS

LG-14-PM

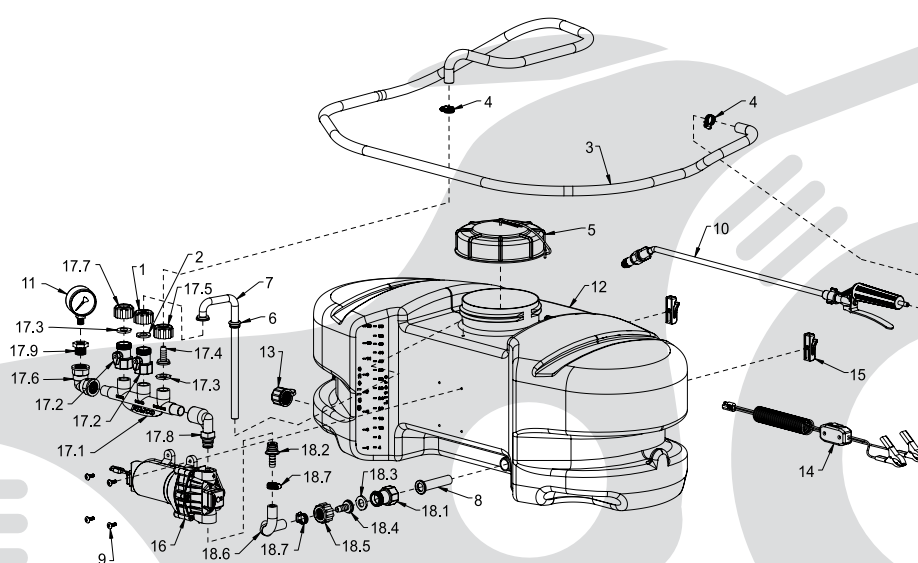

Item	Part No.	Qty	Description
1	5006209	1	Poly Knurled Swivel Nut, 3/4" FGHT
2	5016066	1	#102 Hose Washer (Gasket) 1" O.O. Rubber
3	5020215	1	Hose, 3/8"-1 Brd. x 15 Ft.
4	5051114	2	Hose Clamp, 3/8"
5	5058183	1	FIMCO 5" Threaded Tank Lid
6	5075018	1	Grommet
7	5100357	1	Poly Bypass "J" Hose (Triplex 15 Et 20 G.)
8	5116416	1	PVC Filter Screen, 1" O.O. x 2.81" Long (30 Mesh)
9	5117167	4	#10-24 x 5/8" Phillips Truss Head Machine Screw
10	5163100	1	Low-Flow Handgun w/X-26 Tip
11	5167007	1	Gauge, 0-100 p.s.i.
12	5169242	1	15 Gallon (New Style) Tank
13	5274373	1	Drain Plug Cap, Tether, and Washer Assembly
14	5274443	1	Lead Wire Assembly (w/Switch), 96"
15	5274880	1	Pkg. (2) Handgun Clips Et (2) Screws
16	5275497	1	New Generation 2.1 g.p.m. Pump
17	5275517	1	Manifold Assembly
17.1	5143404	1	Manifold

Item	Part No.	Qty	Description
17.2	5143188	2	#35 Nylon Shut-Off Valve
17.3	5016066	2	#102 Hose Washer (Gasket) 1" O.O. Rubber
17.4	5149034	1	Poly Swivel, 3/8" Hose Barb
17.5	5006209	1	Poly Knurled Swivel Nut, 3/4" FGHT
17.6	5010236	1	Poly Elbow, 1/2" FNPT x 1/2" FNPT
17.7	5046375	1	Poly Knurled Threaded Cap, (3/4" FGHT)
17.8	5010430	1	Port Kit Elbow 1/2" FNPT
17.9	5041073	1	Poly Reducing Bushing, 1/2" MNPT x 1/4" FNPT
18	5275544	1	Intake Sub-Assembly (2.1 Pump on 15 Gal. Units)
18.1	5143188	1	#35 Nylon Shut-Off Valve
18.2	5168836	1	Port Kit Fitting, 3/8" Hose Barb
18.3	5016066	1	#102 Hose Washer (Gasket) 1" O.O. Rubber
18.4	5149034	1	Poly Swivel, 3/8" Hose Barb
18.5	5006209	1	Poly Knurled Swivel Nut, 3/4" FGHT
18.6	5020489	1	Hose, 3/8"-1 Brd . x 5"
18.7	5051114	2	Hose Clamp, 3/8"

PARTS MANUALS

LG-25-PM

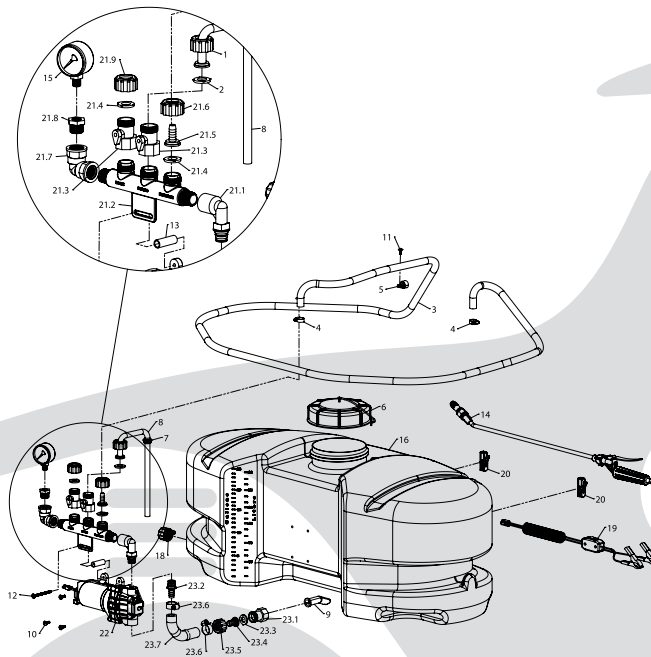

Item	Part No.	Qty	Description
1	5006209	1	Poly Knurled Swivel Nut, 3/4" FGHT
2	5018066	1	Garden Hose Washer
3	5020215	1	Hose, 3/8"-1 Brd. x 15 Ft.
4	5051114	2	Hose Clamp, 3/8"
5	5051122	1	5/8" Black Nylon Loom Cable Clamp
6	5058188	1	Tank Lid w/Lanyard
7	5075018	1	Grommet
8	5100359	1	Poly Bypass "J" Hose (3.8 Pumps Et 2.1 [25] Gallon)
9	5100452	1	Siphon Tube
10	5117167	3	#10-24 x 5/8" Phillips Truss Head Machine Screw
11	5117234	1	#10-24 x 1/2" Phillips Truss Head Machine Screw
12	5117313	1	#10-24 x 2 1/2" Truss Head Machine Screw
13	5127191	1	Manifold Spacer (2.1gpm)
14	5163100	1	Low-Flow Handgun w/X-26 Tip
15	5167007	1	Gauge, 0-100 p.s.i.
16	5169243	1	25 Gallon (New Style) Tank
17	5273959	1	Handgun w/X-26 Tip

Item	Part No.	Qty	Description
18	5274373	1	Drain Plug Cap, Tether, and Washer Assembly
19	5274443	1	Lead Wire Assembly (w/Switch), 96"
20	5274880	1	Pkg. (2) Handgun Clips Et (2) Screws
21	5275517	1	Manifold Assembly
21.1	5010430	1	Port Kit Elbow, 1/2" FNPT
21.2	5143405	1	Manifold w/Mounting Tab
21.3	5143188	2	Nylon Shut-Off Valve
21.4	5016066	2	Garden Hose Washer
21.5	5149034	1	Poly Swivel, 3/8" Hose Barb
21.6	5006209	1	Poly Knurled Swivel Nut, 3/4" FGHT
21.7	5010236	1	Poly Elbow, 1/2" FNPT x 1/2" FNPT
21.8	5041073	1	Poly Reducing Bushing, 1/2" MNPT x 1/4" FNPT
21.9	5046375	1	Poly Knurled Threaded Cap, (3/4" FGHT)
22	5275703	1	Gold Series 2.1 g.p.m. Pump
23	5275877	1	Intake Sub-Assembly
23.1	5143188	1	Nylon Shut-Off Valve
23.2	5168833	1	Port Kit Fitting, 1/2" Hose Barb
23.3	5116242	1	Strainer, 1" Filter Washer
23.4	5149035	1	Poly Swivel, 1/2" Hose Barb
23.5	5006209	1	Poly Knurled Swivel Nut, 3/4" FGHT
23.6	5051022	2	Hose Clamp, 1/2"
23.7	5020497	1	1/2" Polyspring Hose x 6"

PARTS MANUALS

LG-25-HV

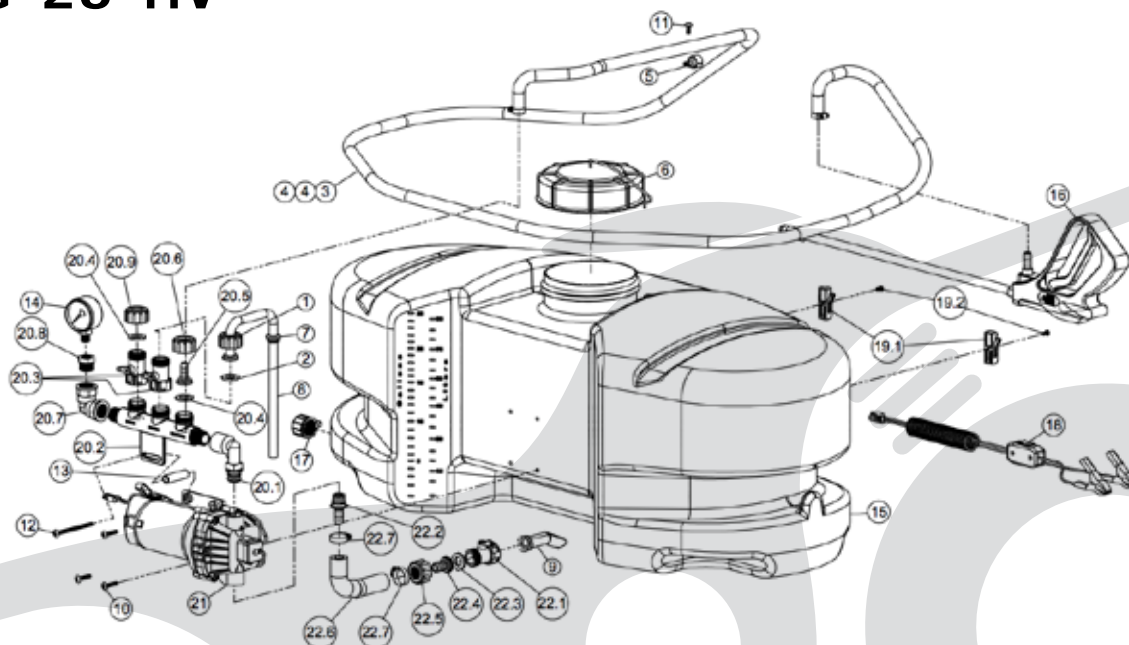

Item	Part No.	Qty	Description
1	5006209	1	Poly Knurled Swivel Nut, 3/4" FGHT
2	5016066	1	Garden Hose Washer
3	5020215	1	Hose, 3/8"-1 Brd. x 15 Ft.
4	5051114	2	Hose Clamp (3/8"-1/2")
5	5051122	1	5/8" Black Nylon Loom Cable Clamp
6	5058188	1	Tank Lid w/Lanyard
7	5075018	1	Grommet
8	5100359	1	Poly Bypass "J" Hose (3.8 Pumps & 2.1 [25] Gallon)
9	5100452	1	Siphon Tube
10	5117168	3	#10-24 x 1" Phillips Truss Head Machine Screw
11	5117234	1	#10-24 x 1/2" Phillips Truss Head Machine Screw
12	5117314	1	#10-24 x 3" Truss Head Machine Screw
13	5127192	1	Manifold Spacer (3.8gpm)
14	5167007	1	Gauge, 0-100 p.s.i.
15	5169243	1	25 Gallon (New Style) Tank
16	5273959	1	Handgun w/X-26 Tip
17	5274373	1	Drain Plug Cap, Tether, and Washer Assembly
18	5274443	1	Lead Wire Assembly (w/Switch), 96"
19.1	5053096	2	Handgun Clip, for Blow-Molded Tanks
19.2	5117293	2	#10-24 x 3/8" Phillips Round Head Machine Screw
20	5275517	1	Manifold Assembly
20.1	5010430	1	Port Kit Elbow, 1/2" FNPT
20.2	5143405	1	Manifold w/Mounting Tab

Item	Part No.	Qty	Description
20.3	5143188	2	Nylon Shut-Off Valve
20.4	5016066	2	Garden Hose Washer
20.5	5149034	1	Poly Swivel, 3/8" Hose Barb
20.6	5006209	1	Poly Knurled Swivel Nut, 3/4" FGHT
20.7	5010236	1	Poly Elbow, 1/2" FNPT x 1/2" FNPT
20.8	5041073	1	Poly Reducing Bushing, 1/2" MNPT x 1/4" FNPT
20.9	5046375	1	Poly Knurled Threaded Cap, (3/4" FGHT)
21	5275704	1	Gold Series 3.8 g.p.m. Pump
22	5275877	1	Intake Sub-Assembly
22.1	5143188	1	Nylon Shut-Off Valve
22.2	5168833	1	Port Kit Fitting, 1/2" Hose Barb
22.3	5116242	1	Strainer, 1" Filter Washer
22.4	5149035	1	Poly Swivel, 1/2" Hose Barb
22.5	5006209	1	Poly Knurled Swivel Nut, 3/4" FGHT
22.6	5020497	1	1/2" Polyspring Hose x 6"
22.7	5051114	2	Hose Clamp (3/8"-1/2")

LG-40-SS

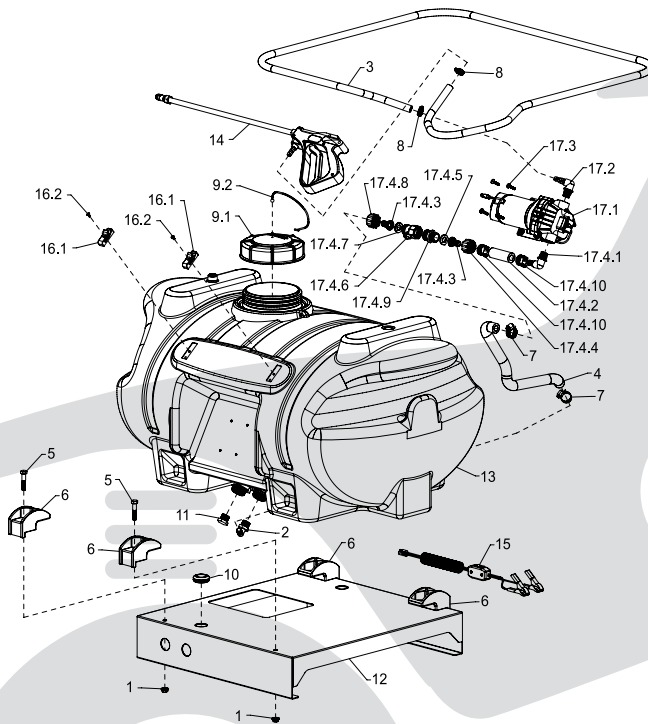

Item	Part No.	Qty	Description
1	5006259	4	3/8"-16 Hex Whiz (Flange) Locknut
2	5010039	1	Nylon Elbow, 1/2" MNPT x 1/2" HB
3	5020135	1	Hose. 3/8"-1 Brd. x 25 Ft.
4	5020416	1	Hose. 1/2"-1 Brd. x 193/8"
5	50341 1	4	I-II-1." 3/8"-16 x 13/4"
6	5038698	4	Plastic Tank Hold-Down Lea Clip
7	5051022	2	Hose Clamp, 1/2"
8	5051114	2	Hose Clamp, 3/8"
9	5058183	1	FIMCO 5" Threaded Tank Lid w/Lanyard
9.1	5 5K18:~	1	f-111J, >" nk in
9.2	5058170	1	Tank Lid Lanyard, 8" (Black)
10	5075015	1	Rilhhher Grommet
11	5102024	1	Nylon Pipe Plug, 1/2" MNPT
12	5156025	1	40 Gallon Spot Sprayer Skid
13	5169245	1	40 Gallon Elliptical Tank (White)
14	5273959	1	Handaun w/X-26 Tip

Item	Part No.	Qty	Description
15	5275459	1	Lead Wire Assembly (w/Switch), 96"
16	5274880	1	Pkg. (2) Handgun Clips Et (2) Screws
16.1	5053096	2	HandQun Clip, for Blow-Molded Tanks
16.2	5117293	2	#10-24 x 3/8" Phillips Round Head Machine Screw
17	5275185	1	Pump Assembly
17.1	5275498	1	New Generation 3.8 Q.p.m. Pump
17.2	5010424	1	90 Degree Port Elbow Fitting, 3/8" Hose Barb
17.3	5117168	4	#10-24 x 1" Phillips Truss Head Machine Screw
17.4	5275547	1	FittinQ/Hose Sub-Assembly (LG-40-SS)
17.4.1	5010426	1	90 Degree Port Elbow Fitting, 1/2" Hose Barb
17.4.2	5c2006C	1	Hose. 1/2"- Brd. x 2 3/4"
17.4.3	5149011	2	Nylon Swivel, 1/2" Flat Seat Hose Barb
17.4.4	5006056	1	Nylon Swivel Nut, 3/4" FNPT
17.4.5	5116242	1	Strainer 1" t-iller wasner
17.4.6	5143188	1	#35 Nylon Shut-Off Valve
17.4.7	5016066	1	#102 Hose " DRubber
17.4.8	5006055	1	Nylon Swivel Nut, 3/4" FGHT
17.4.9	5005022	1	Nylon Male Street Adapter, 3/4" MGH T x 3/4" MNPT
17.4.10	5051022	2	Hose Clamp, 1/2"



PARTS MANUALS

LG-55-3PT

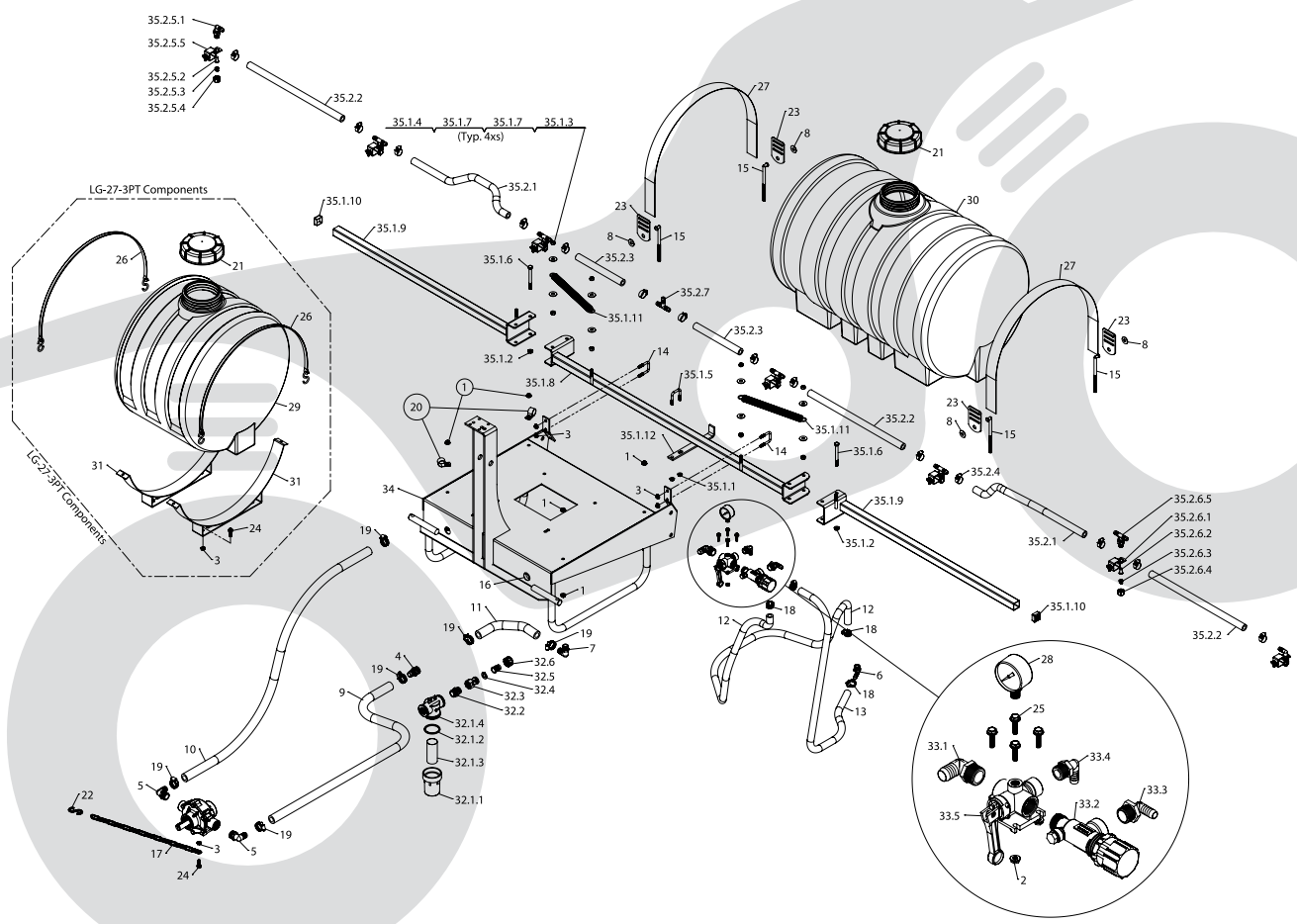

PARTS MANUALS

LG-55-3PT Cont.

Item	Part No.	Qty	Description
1	5006259	8	3/8"-16 Hex Whiz (Flange) Locknut
2	5006306	4	1/4"-20 Hex Whiz (Flange) Locknut
3	5006307	9	5/16"-18 Hex Whiz (Flange) Locknut
4	5010020	2	Nylon Fitting, 3/4" MNPT x 3/4" HB
5	5010028	2	Nylon Elbow, 3/4" MNPT x 3/4" HB
6	5010039	1	Nylon Elbow, 1/2" MNPT x 1/2" HB
7	5010152	1	Nylon Elbow, 1/2" MNPT x 3/4" HB
8	5016030	4	Flatwasher, 3/8"
9	5020105	1	Hose, 3/4"-2 Brd. x 36"
10	5020227	1	Hose, 3/4"-1 Brd. x 48"
11	5020387	1	Hose, 3/4"-2 Brd. x 10"
12	5020388	1	Hose, 1/2"-1 Brd. x 64"
13	5020389	1	Hose, 1/2"-1 Brd. x 43"
14	5034159	2	Square U-Bolt, 5/16" x 1 5/16" x 1 7/8"
15	5034298	4	3/8" x 6" L-Head Hook Bolt
16	5041105	1	Snap Bushing
17	5049017	1	Torque Chain, 24"
18	5051022	4	Hose Clamp, 1/2"
19	5051024	6	Hose Clamp, 3/4"
20	5053027	2	Hose Clip
21	5058188	2	Tank Lid w/Lanyard
22	5082006	1	"S" Hook
23	5108042	4	Tank Strap Buckle, Straight
24	5117300	5	5/16"-18 x 1" Flange Whiz Lock Screw
25	5117301	4	1/4"-20 x 1" Hex Flange Screw
26	5133093	2	Rubber Strap, 21"
27	5133100	2	Nylon Strap, 60"
28	5167005	1	Gauge, 0-400 p.s.i. (Dry)
29	5169058	1	25 Gallon Tank
30	5169247	1	55 Gallon Leg Tank, White, (2) 1/2" Fittings
31	5271945	2	Saddle Weldment
32	5274745	1	Strainer Sub-Assembly
32.1	5116322	1	3/4" Black Poly Strainer
32.1.1	5058125	1	Strainer Bowl
32.1.2	5072229	1	EPDM Gasket
32.1.3	5116323	1	40 Mesh Screen
32.1.4	5046088	1	Strainer Cap
32.2	5005022	1	Nylon Male Street Adapter, 3/4" MGHT x 3/4" MNPT
32.3	5143188	1	Nylon Shut-Off Valve
32.4	5016066	1	Garden Hose Washer
32.5	5149013	1	Nylon Swivel, 3/4" Flat Seat Hose Barb
32.6	5006055	1	Nylon Swivel Nut, 3/4" FGHT

Item	Part No.	Qty	Description
33	5274746	1	Valve Sub-Assembly
33.1	5010028	1	Nylon Elbow, 3/4" MNPT x 3/4" HB
33.2	5143199	1	Pressure Relief Valve, (3/4" NPT)
33.3	5010036	1	Nylon Elbow, 3/4" MNPT x 1/2" HB
33.4	5010039	1	Nylon Elbow, 1/2" MNPT x 1/2" HB
33.5	5143316	1	Directo-Valve
34	5275760	1	55 Gallon 3-Pt. Carrier (RED)
35	BK-70A	1	7-Nozzle Boom Assembly (BK-70A)
35.1	5274507	1	Boom Sub-Assembly (7-Nozzle)
35.1.1	5006307	2	5/16"-18 Hex Whiz (Flange) Locknut
35.1.2	5006345	2	3/8"-16 Flange Locknut (Grade F)
35.1.3	5006092	4	3/8"-16 Hex Locknut
35.1.4	5006054	4	3/8"-16 Hex Nut
35.1.5	5034159	1	Square U-Bolt, 5/16" x 1 5/16" x 1 7/8"
35.1.6	5034563	2	H.H.C.S., 3/8"-16 X 3 3/4"
35.1.7	5016030	8	Flatwasher, 3/8"
35.1.8	5274458	1	Center Boom Weldment (BK-70)
35.1.9	5274459	2	Outer Boom Weldment
35.1.10	5046344	2	Square Cap, Black (1 1/4" Square Tube)
35.1.11	5019228	2	Extension Spring
35.1.12	5038620	1	Boom Retainer Bracket
35.2	5274555	1	Harness Assembly (BK-70)
35.2.1	5020307	2	Hose, 1/2"-1 Brd. x 23"
35.2.2	5020416	3	Hose, 1/2"-1 Brd. x 19 3/8"
35.2.3	5020144	2	Hose, 1/2"-1 Brd. x 10"
35.2.4	5051022	14	Hose Clamp, 1/2"
35.2.5	5275067	2	Standard "ELL" Nozzle Sub-Assembly
35.2.5.1	5056023	1	Nylon Elbow Assembly, 11/16" U.N.F. x 1/2" HB
35.2.5.2	5116019	1	50 Mesh Nozzle Strainer, Red
35.2.5.3	5138571	1	Nylon Standard Flat Tip, 80 Degree, Yellow
35.2.5.4	5046052	1	Nylon Nozzle Cap, 11/16" U.N.F. Thread
35.2.5.5	5273796	1	1 1/4" Square Boom Nozzle Clamp (BC114)
35.2.6	5275068	5	Standard "Tee" Nozzle Sub-Assembly
35.2.6.1	5273796	1	1 1/4" Square Boom Nozzle Clamp (BC114)
35.2.6.2	5116019	1	50 Mesh Nozzle Strainer, Red
35.2.6.3	5138571	1	Nylon Standard Flat Tip, 80 Degree, Yellow
35.2.6.4	5046052	1	Nylon Nozzle Cap, 11/16" U.N.F. Thread
35.2.6.5	5056027	1	Nylon Tee, 11/16" U.N.F. x 1/2" HB-1/2" HB
35.2.7	5086003	1	Nylon Hose Tee, 1/2" HB

PARTS MANUALS

ATV-BK-200

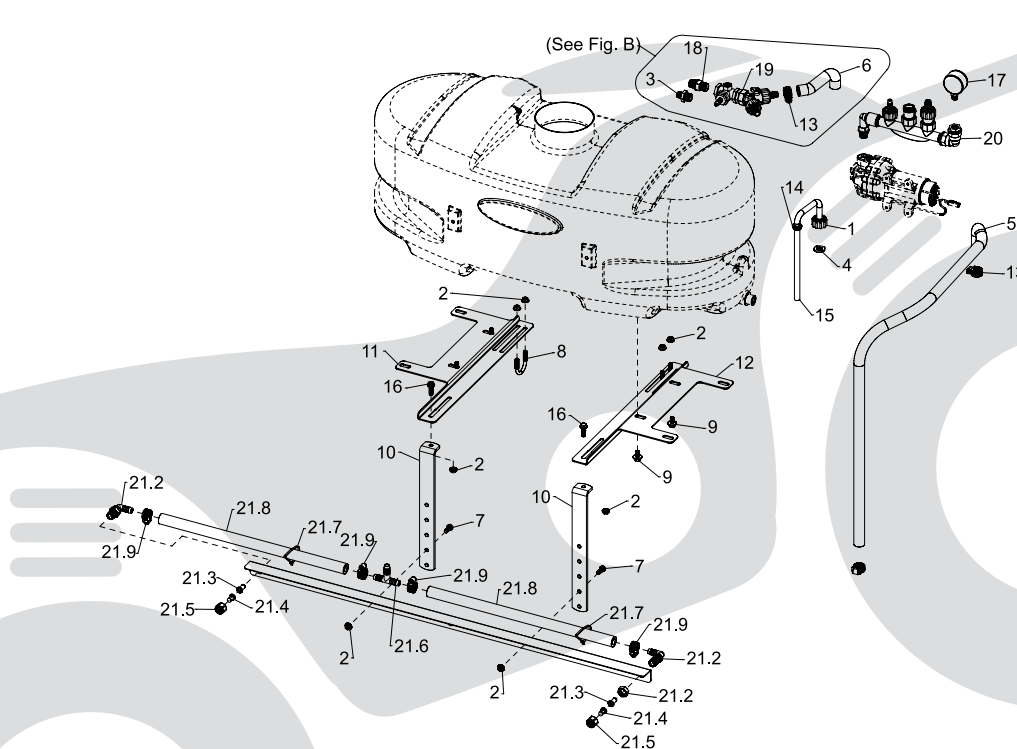

Item	Part No.	Qty	Description
1	5006209	1	Poly Knurled Swivel Nut, 3/4" FGHT
2	5006307	8	5/16"-18 Hex Whiz (Flange) Locknut
3	5011128	1	Nylon Reducing Nipple, 1/2" MNPT x 3/8" MNPT
4	5016066	1	Garden Hose Washer
5	5020122	1	Hose 1/2"-1 Brd. x 48"
6	5020241	1	Hose 1/2"-1 Brd. x 6"
7	5034038	2	H.H.C.S. 5/16"-18 x 3/4"
8	5034220	2	Round U-Bolt 5/16"-18 x 1 5/16" x 1 3/4"
9	5034531	4	5/16"-18 x 5/8" Flange Lock Screw
10	5038506	2	Boom Mounting Bracket
11	5038667	1	Tank Mounting Plate (L.H.) (ATV)
12	5038725	1	Tank Mounting Plate (R.H.) (ATV)
13	5051022	3	Hose Clamp, 1/2"
14	5075018	1	Grommet
15	5100359	1	Poly Bypass "J" Hose (3.8 Pumps Et 2.1 [25] Gallo 1)

Item	Part No.	Qty	Description
16	5117300	2	5/16"-18 x 1" Flange Whiz Lock Screw
17	5167007	1	Gauge, 0-100 p.s.i.
18	5168832	1	Port Kit Fitting, 1/2" MNPT
19	5275118	1	Plumbing Sub-Assembly
20	5275516	1	Manifold Assembly
21	5275726	1	2-Nozzle Boom Assembly
21.1	5022411	1	Boom Mount Angle
21.2	5056023	2	Nylon Elbow Assembly, 11/16" U.N.F. x 1/2" HB
21.3	5116019	2	50 Mesh Nozzle Strainer Red
21.4	5138512	2	Deflectip (Gray)
21.5	5046052	2	Nylon Nozzle Cap, 11/16" U.N.F. Thread
21.6	5086003	1	Nylon Hose Tee, 1/2" HB
21.7	5133094	2	Nylon Cable Tie
21.8	5020416	2	Hose 1/2"-1 Brd. x 19 3/8"
21.9	5051022	4	Hose Clamp, 1/2"

PARTS MANUALS

ATV-BK-3025

Exploded View/Parts List:
ATVBK-3025 (5301484)

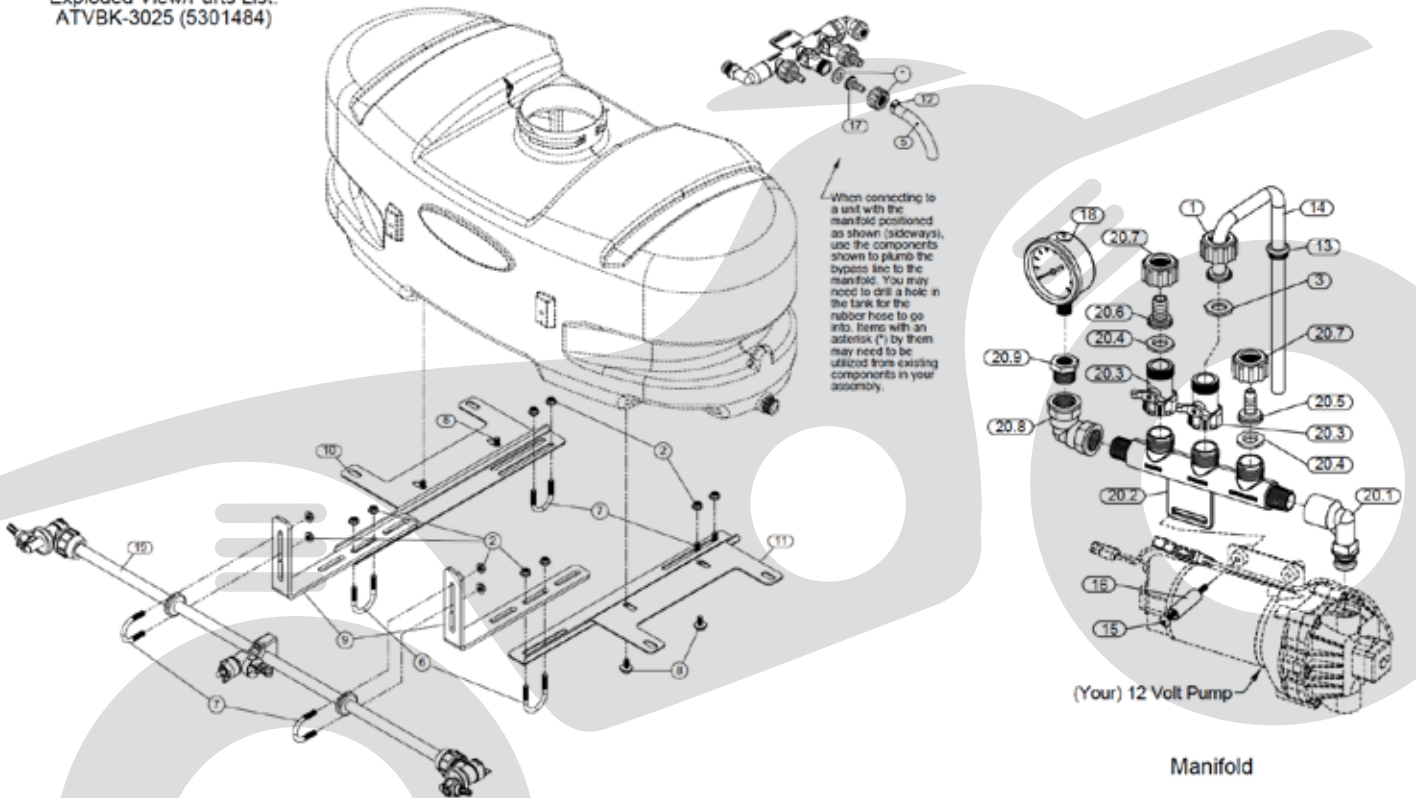

Item	Part No.	Qty	Description
1	5006209	1	Poly Knurled Swivel Nut, 3/4" FGHT
2	5006307	12	5/16"-18 Hex Whiz (Flange) Locknut
3	5016066	1	Garden Hose Washer
4	5020389	1	Hose, 1/2"-1 Brd. x 43"
5	5020490	1	Hose, 3/8"-1 Brd. x 7 1/4"
6	5034065	2	Round U-Bolt, 5/16"-18 x 1 1/2" x 2 3/16"
7	5034220	4	Round U-Bolt, 5/16"-18 x 1 5/16" x 1 3/4"
8	5034531	4	5/16"-18 x 5/8" Flange Lock Screw
9	5038665	2	Boom Mounting Bracket
10	5038667	1	Tank Mounting Plate (L.H.) (ATV)
11	5038725	1	Tank Mounting Plate (R.H.) (ATV)
12	5051114	3	Hose Clamp (3/8"-1/2")
13	5075018	1	Grommet
14	5100359	1	Poly Bypass "J" Hose (3.8 Pumps Et 2.1 [25] Gallon)

Item	Part No.	Qty	Description
15	5117314	1	#10-24 x 3" Truss Head Machine Screw
16	5127192	1	Manifold Spacer (3.8gpm)
17	5149034	1	Poly Swivel, 3/8" Hose Barb
18	5167031	1	Gauge, Liquid-Filled, 0-100 PSI
19	5275260	1	"Wet Boom" Assembly
20	5275516	1	Manifold Assembly
20.1	5010430	1	Port Kit Elbow, 1/2" FNPT
20.2	5143405	1	Manifold w/Mounting Tab
20.3	5143188	2	Nylon Shut-Off Valve (3/4" GHT)
20.4	5016066	2	Garden Hose Washer
20.5	5149034	1	Poly Swivel, 3/8" Hose Barb
20.6	5149035	1	Poly Swivel, 1/2" Hose Barb
20.7	5006209	2	Poly Knurled Swivel Nut, 3/4" FGHT
20.8	5010236	1	Poly Elbow, 1/2" FNPT x 1/2" FNPT
20.9	5041073	1	Poly Reducing Bushing, 1/2" MNPT x 1/4" FNPT



PARTS MANUALS

ATV-BK-3025

#5275260 "Wet" Boom Assembly

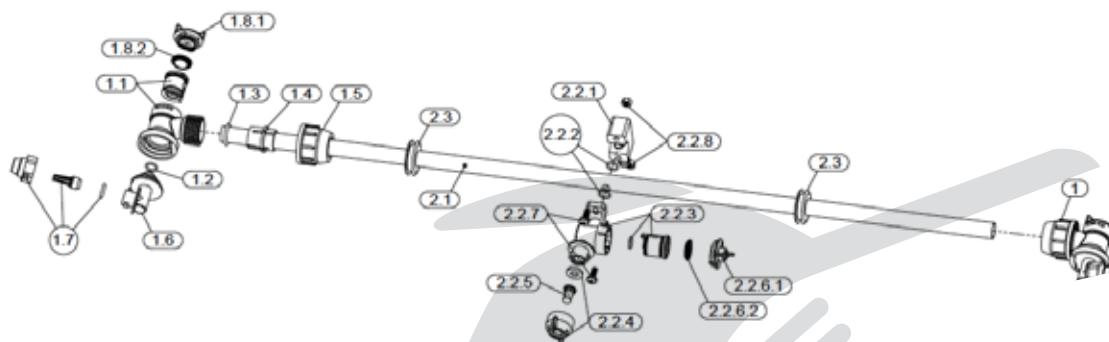

After Spraying

After use, fill the sprayer tank part way with water. Start the sprayer, and allow the clear water to be pumped through the plumbing system and out through the spray nozzles.

Refill the tank about half full with plain water and use FIMCO Tank Neutralizer and Cleaner, and repeat cleaning instructions above.

Flush the entire sprayer with the neutralizing/cleaning agent, then flush out one more time with plain water. Follow the chemical manufacturer's disposal instructions of all wash or rinsing water.

For the boom, (if applicable) remove the tips and screens from the nozzle assemblies. Wash these items out thoroughly. Blow the orifice clean and dry. If the orifice remains clogged, clean it with a fine bristle (NOT WIRE) brush, or with a toothpick. Do not damage the orifice. Water rinse and dry the tips before storing.

Winter Storage

Drain all water out of your sprayer, paying special attention to the pump, handgun, and valve(s). These items are especially prone to damage from chemicals and freezing weather.

The sprayer should be winterized before storage by pumping a solution of RV antifreeze through the entire plumbing system. This antifreeze solution should remain in the plumbing system during the winter months. When spring time comes and you are preparing your sprayer for the spray season, rinse the entire plumbing system out, clearing the lines of the antifreeze solution. Proper care and maintenance will prolong the life of your sprayer.

WARNING: Some chemicals will damage the pump valves if allowed to soak untreated for a length of time! ALWAYS flush the pump as instructed after each use.

Item	Part No.	Qty	Description
1	5275122	2	End Nozzle Assembly (Wet Boom)
1.1	5002499	1	Boomless Nozzle Body w/Core (Outer)
1.2	5072518	1	Stem O-Ring
1.3	5072517	1	Compression O-Ring
1.4	5010427	1	Compression Olive
1.5	5006348	1	Flynut
1.6	5132073	1	Nozzle Holder Stem
1.7	5274861	1	XT Spray Nozzle, Cap, Et O-Ring
1.8.1	5088024	1	Yellow ON/OFF Valve Knob
1.8.2	5063255	1	Diaphragm
2	5275712	1	Wet Boom Sub-Assembly
2.1	5100316	1	Boom Tube

Item	Part No.	Qty	Description
2.2	5275123	1	Center Nozzle Assembly (Wet Boom)
2.2.1	5051137	1	Hose Barb Saddle
2.2.2	5072509	2	O-Ring
2.2.3	5002500	1	Center Nozzle Body w/Core
2.2.4	5274862	1	Center Boomless Nozzle Cap w/Gasket
2.2.5	5018329	1	Red Spray Tip
2.2.6.1	5088024	1	Yellow ON/OFF Valve Knob
2.2.6.2	5063255	1	Diaphragm
2.2.7	5117310	2	SS Screw, 6mm x 16mm (5/8")
2.2.8	5006347	2	SS Nut, 6mm
2.3	5075016	2	Rubber Grommet

Typical Spray Pattern Produced By This Boom Assembly

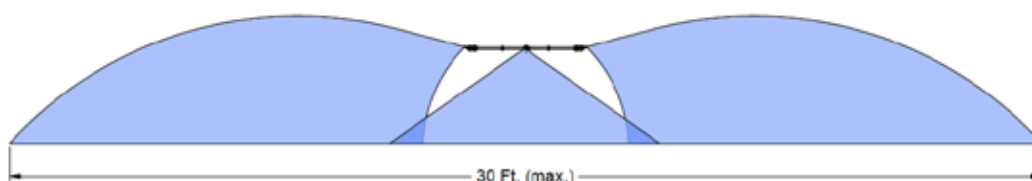

PARTS MANUALS

ATV-BK-500

Item	Part No.	Qty	Description
1	5006209	1	Poly Knurled Swivel Nut, 3/4" FGHT
2	5006307	10	5/16"-18 Hex Whiz (Flange) Locknut
3	5011128	1	Nylon Reducing Nipple, 1/2" MNPT x 3/8" MNPT
4	5016066	1	Garden Hose Washer
5	5020122	1	Hose, 1/2"-1 Brd. x 48"
6	5020241	1	Hose, 1/2"-1 Brd. x 6"
7	5034159	2	Square U-Bolt, 5/16" x 1 5/16" x 1 7/8"
8	5034220	2	Round U-Bolt, 5/16"-18 x 1 5/16" x 1 3/4"
9	5034531	4	5/16"-18 x 5/8" Flange Lock Screw
10	5038506	2	Boom Mounting Bracket
11	5038667	1	Tank Mounting Plate (L.H.) (ATV)
12	5038725	1	Tank Mounting Plate (R.H.) (ATV)
13	5051022	3	Hose Clamp, 1/2"
14	5075018	1	Grommet
15	5100359	1	Poly Bypass "J" Hose (3.8 Pumps & 2.1 [25] Gallon)
16	5117300	2	5/16"-18 x 1" Flange Whiz Lock Screw
17	5167007	1	Gauge, 0-100 p.s.i.
18	5168832	1	Port Kit Fitting, 1/2" MNPT
19	5272460	1	5-Nozzle Harness Assembly
19.1	5020306	1	Hose, 1/2"-1 Brd. x 20"
19.2	5086003	1	Nylon Hose Tee, 1/2" HB
19.3	5020144	2	Hose, 1/2"-1 Brd. x 10"
19.4	5020009	2	Hose, 1/2"-1 Brd. x 26"
19.5	5051022	10	Hose Clamp, 1/2"
19.6	5275068	3	Standard "Tee" Nozzle Sub-Assembly
19.6.1	5273796	1	1 1/4" Square Boom Nozzle Clamp (BC114)
19.6.2	5116019	1	50 Mesh Nozzle Strainer, Red
19.6.3	5138571	1	Nylon Standard Flat Tip, 80 Degree, Yellow
19.6.4	5046052	1	Nylon Nozzle Cap, 11/16" U.N.F. Thread
19.6.5	5056027	1	Nylon Tee, 11/16" U.N.F. x 1/2" HB-1/2" HB
19.7	5275067	2	Standard "ELL" Nozzle Sub-Assembly
19.7.1	5056023	1	Nylon Elbow Assembly, 11/16" U.N.F. x 1/2" HB
19.7.2	5116019	1	50 Mesh Nozzle Strainer, Red
19.7.3	5138571	1	Nylon Standard Flat Tip, 80 Degree, Yellow
19.7.4	5046052	1	Nylon Nozzle Cap, 11/16" U.N.F. Thread
19.7.5	5273796	1	1 1/4" Square Boom Nozzle Clamp (BC114)
20	5274361	1	5-Nozzle Boom Sub-Assembly
20.1	5034159	2	Square U-Bolt, 5/16" x 1 5/16" x 1 7/8"
20.2	5006307	4	5/16"-18 Hex Whiz (Flange) Locknut
20.3	5273990	1	5-Nozzle Boom Weldment (Center Section)
20.4	5009914	2	Outer Boom Tube
20.5	5017660	1	End Plate (R.H.)
20.6	5017659	1	End Plate (L.H.)
20.7	5006344	2	1/4"-20 Flange Locknut
20.8	5046344	2	Square Cap, Black (1 1/4" Square Tube)

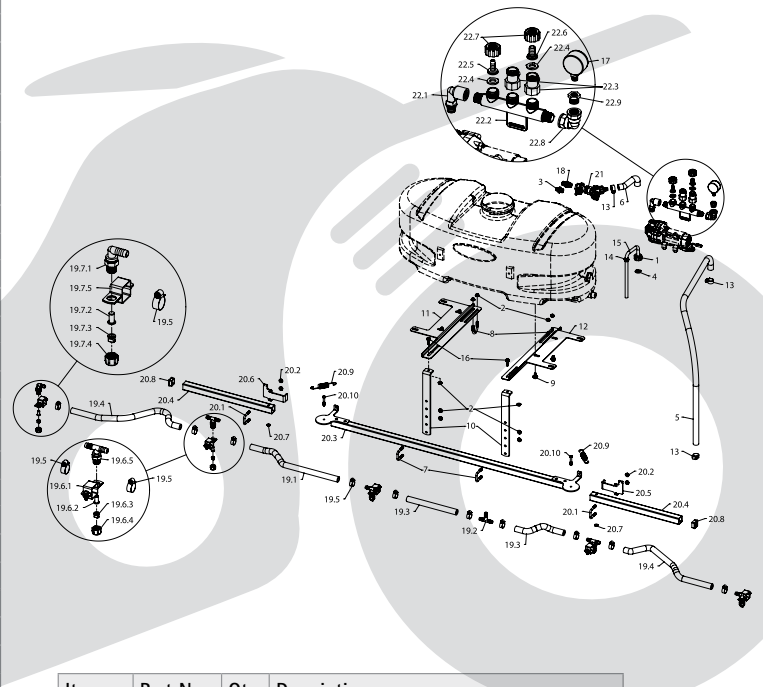

Item	Part No.	Qty	Description
20.9	5019138	2	Extension Spring
20.10	5034204	2	H.H.C.S., 1/4"-20 x 1 3/4"
21	5275118	1	Plumbing Sub-Assembly
21.1	5010193	1	Nylon Tee, 1/2" FNPT w/1/4" Port (Gauge)
21.2	5143204	1	Dual-Shut-Off Y-Valve, 3/4" GHT
21.3	5005021	1	Nylon Adapter, 1/2" MNPT x 3/4" MGHT
21.4	5006055	2	Nylon Swivel Nut, 3/4" FGHT
21.5	5016066	2	Garden Hose Washer
21.6	5149011	2	Nylon Swivel, 1/2" Flat Seat Hose Barb
21.7	5067016	1	Nylon Fitting, 1/2" MNPT x 3/8" HB
22	5275516	1	Manifold Assembly
22.1	5010430	1	Port Kit Elbow, 1/2" FNPT
22.2	5143405	1	Manifold w/Mounting Tab
22.3	5143188	2	Nylon Shut-Off Valve
22.4	5016066	2	Garden Hose Washer
22.5	5149034	1	Poly Swivel, 3/8" Hose Barb
22.6	5149035	1	Poly Swivel, 1/2" Hose Barb
22.7	5006209	2	Poly Knurled Swivel Nut, 3/4" FGHT
22.8	5010236	1	Poly Elbow, 1/2" FNPT x 1/2" FNPT
22.9	5041073	1	Poly Reducing Bushing, 1/2" MNPT x 1/4" FNPT



PARTS MANUALS

ATVBK-700

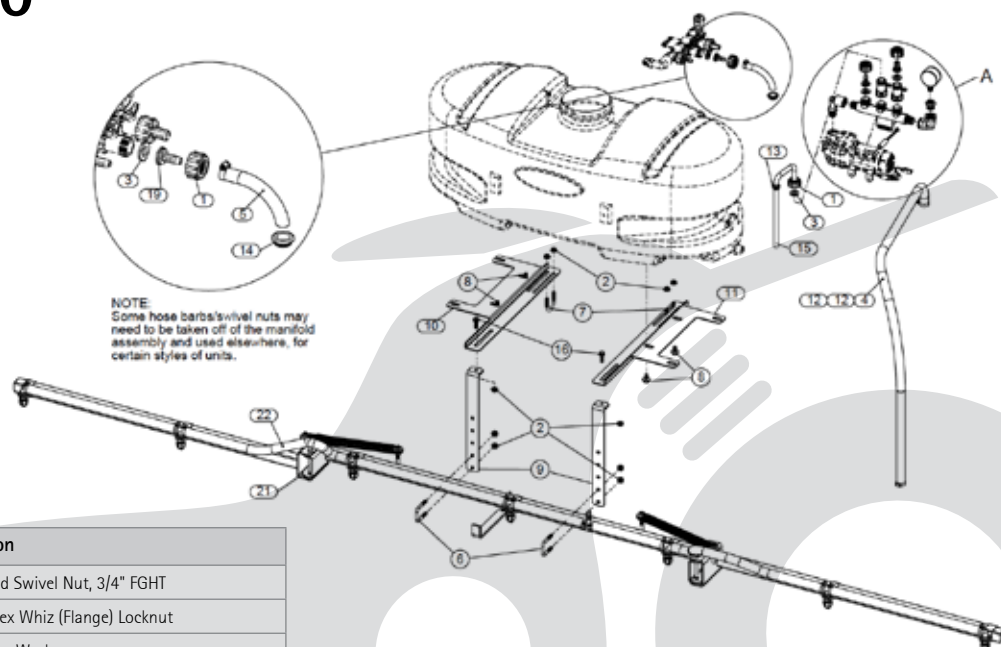

Item	Part No.	Qty	Description
1	5006209	2	Poly Knurled Swivel Nut, 3/4" FGHT
2	5006307	10	5/16"-18 Hex Whiz (Flange) Locknut
3	5016066	2	Garden Hose Washer
4	5020122	1	Hose, 1/2"-1 Brd. x 48"
5	5020490	1	Hose, 3/8"-1 Brd. x 7 1/4"
6	5034159	2	Square U-Bolt, 5/16" x 1 5/16" x 1 7/8"
7	5034220	2	Round U-Bolt, 5/16"-18 x 1 5/16" x 1 3/4"
8	5034531	4	5/16"-18 x 5/8" Flange Lock Screw
9	5038506	2	Boom Mounting Bracket
10	5038667	1	Tank Mounting Plate (L.H.) (ATV)
11	5038725	1	Tank Mounting Plate (R.H.) (ATV)
12	5051114	3	Hose Clamp (3/8"-1/2")
13	5075018	1	Grommet
14	5075022	1	Grommet (5/8" I.D.)
15	5100359	1	Poly Bypass "J" Hose (3.8 Pumps & 2.1 [25] Gallon)
16	5117300	2	5/16"-18 x 1" Flange Whiz Lock Screw
17	5117313	1	#10-24 x 2 1/2" Truss Head Machine Screw
18	5127191	1	Manifold Spacer (2.1gpm)
19	5149034	1	Poly Swivel, 3/8" Hose Barb
20	5167007	1	Pressure Gauge, 0-100 p.s.i.
21	5274507	1	Boom Sub-Assembly (7-Nozzle)
22	5274555	1	Harness Assembly (BK-70)
23	5275516	1	Manifold Assembly
23.1	5010430	1	Port Kit Elbow, 1/2" FNPT
23.2	5143405	1	Manifold w/Mounting Tab
23.3	5143188	2	Nylon Shut-Off Valve (3/4" GHT)
23.4	5016066	2	Garden Hose Washer
23.5	5149034	1	Poly Swivel, 3/8" Hose Barb
23.6	5149035	1	Poly Swivel, 1/2" Hose Barb
23.7	5006209	2	Poly Knurled Swivel Nut, 3/4" FGHT
23.8	5010236	1	Poly Elbow, 1/2" FNPT x 1/2" FNPT
23.9	5041073	1	Poly Reducing Bushing, 1/2" MNPT x 1/4" FNPT

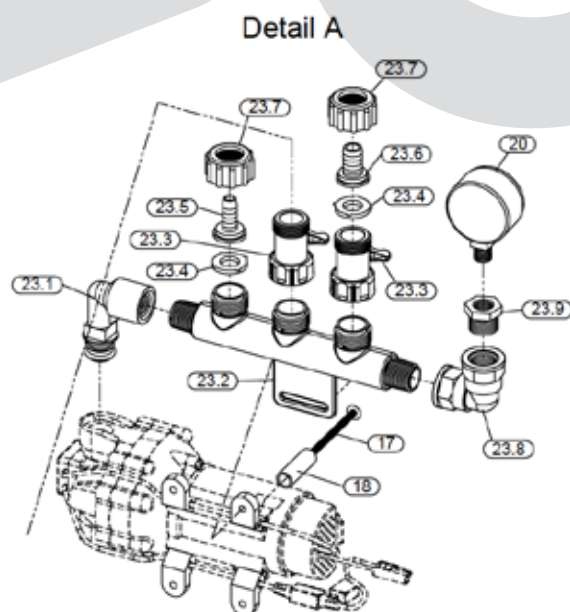

NOTE:
A pump is shown in this assembly, but is NOT included with the boom kit. Shown for connection purposes only.

PARTS MANUALS

ATVBK-710

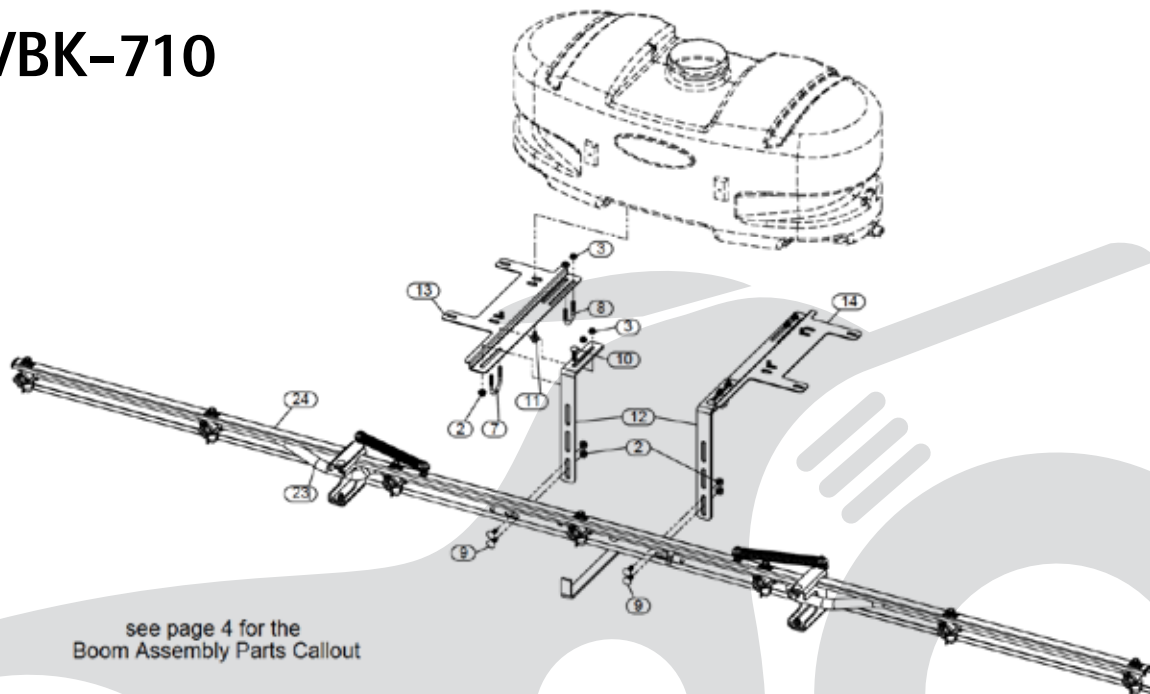

see page 4 for the
Boom Assembly Parts Callout

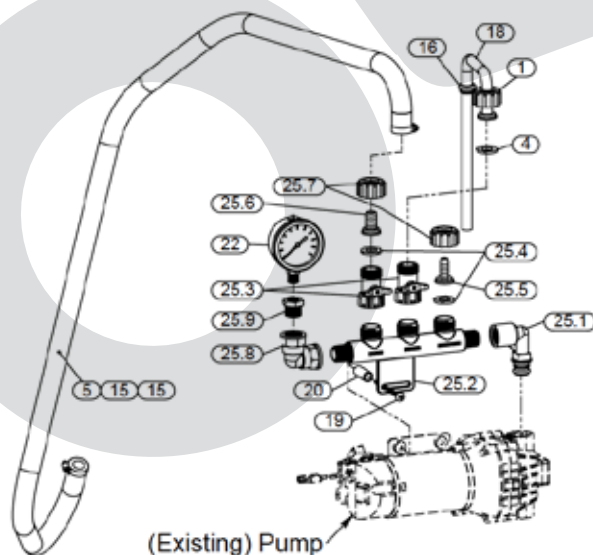

With your pump mounted on the 'side' of your tank,
this will be your plumbing configuration/setup.

Item	Part No.	Qty	Description
1	5006209	2	Poly Knurled Swivel Nut, 3/4" FGHT
2	5006259	6	3/8"-16 Hex Whiz (Flange) Locknut
3	5006307	8	5/16"-18 Hex Whiz (Flange) Locknut
4	5016066	2	Garden Hose Washer
5	5020122	1	Hose, 1/2"-1 Brd. x 48"
6	5020490	1	Hose, 3/8"-1 Brd. x 7 1/4"
7	5034065	2	Round U-Bolt, 5/16"-18 x 1 1/2" x 2 3/16"
8	5034220	2	Round U-Bolt, 5/16"-18 x 1 5/16" x 1 3/4"
9	5034482	4	Carriage Bolt, 3/8"-16 x 1"
10	5034524	2	Carriage Bolt, 3/8"-16 x 1 1/4"
11	5034531	4	5/16"-18 x 5/8" Flange Lock Screw
12	5038665	2	Boom Mounting Bracket
13	5038667	1	Tank Mounting Plate (L.H.) (ATV)
14	5038725	1	Tank Mounting Plate (R.H.) (ATV)
15	5051114	3	Hose Clamp (3/8"-1/2")
16	5075018	1	Grommet
17	5075022	1	Grommet (5/8" I.D.)
18	5100359	1	Poly Bypass "J" Hose (3.8 Pumps Et 2.1 [25] Gallon)
19	5117314	1	#10-24 x 3" Truss Head Machine Screw
20	5127192	1	Manifold Spacer (3.8gpm)
21	5149034	1	Poly Swivel, 3/8" Hose Barb
22	5167031	1	Gauge, Liquid-Filled, 0-100 PSI
23	5274509	1	7-Nozzle Harness Assembly (QJD Nozzles)
24	5274770	1	Boom Assembly
25	5275516	1	Manifold Assembly
25.1	5010430	1	Port Kit Elbow, 1/2" FNPT
25.2	5143405	1	Manifold w/Mounting Tab
25.3	5143188	2	Nylon Shut-Off Valve (3/4" GHT)
25.4	5016066	2	Garden Hose Washer
25.5	5149034	1	Poly Swivel, 3/8" Hose Barb
25.6	5149035	1	Poly Swivel, 1/2" Hose Barb
25.7	5006209	2	Poly Knurled Swivel Nut, 3/4" FGHT
25.8	5010236	1	Poly Elbow, 1/2" FNPT x 1/2" FNPT
25.9	5041073	1	Poly Reducing Bushing, 1/2" MNPT x 1/4" FNPT

PARTS MANUALS

ATVBK-710 Cont

Deluxe Boom Assembly

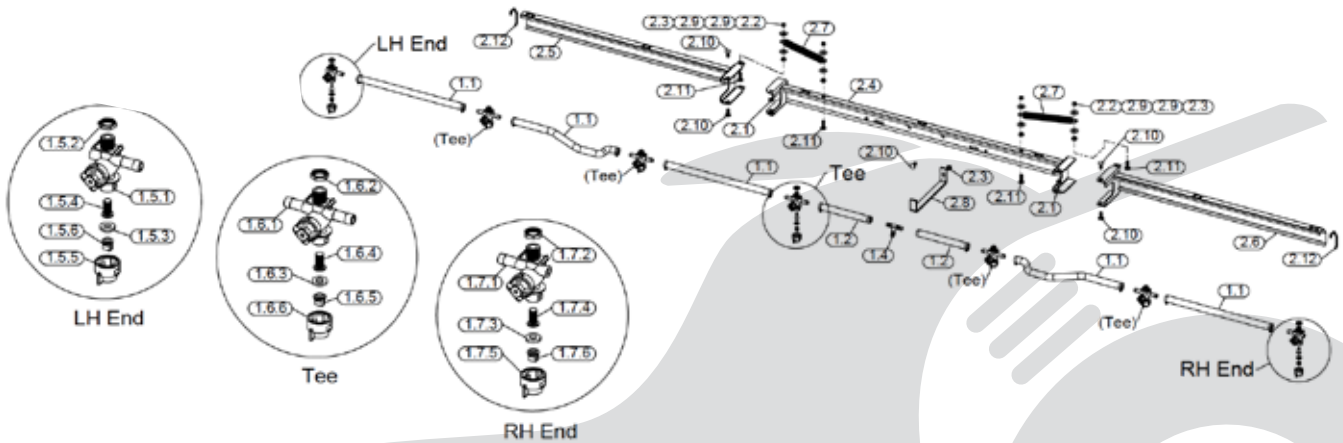

Item	Part No.	Qty	Description
1	5274509	1	7-Nozzle Harness Assembly (QJD Nozzles)
1.1	5020416	5	Hose, 1/2"-1 Brd. x 19 3/8"
1.2	5020144	2	Hose, 1/2"-1 Brd. x 10"
1.3	5051114	14	Hose Clamp (3/8"-1/2")
1.4	5086003	1	Nylon Hose Tee, 1/2" HB
1.5	5275339	1	(L.H.) Single Deluxe Nozzle Assembly
1.5.1	5002489	1	Quick TeeJet Nozzle, 1/2" Single - Left
1.5.2	5006087	1	Brass Nut for Quick TeeJet Nozzles
1.5.3	5016157	1	Seat Washer (QJ Caps)
1.5.4	5116019	1	Nozzle Strainer, Red (50 Mesh)
1.5.5	5046219	1	Quick TeeJet Cap (Yellow)
1.5.6	5018265	1	80 Degree Flat Spray Tip, Yellow
1.6	5275341	5	Double Deluxe Nozzle Assembly
1.6.1	5002491	1	Quick TeeJet Nozzle, 1/2" Double
1.6.2	5006087	1	Brass Nut for Quick TeeJet Nozzles
1.6.3	5016157	1	Seat Washer (QJ Caps)
1.6.4	5116019	1	Nozzle Strainer, Red (50 Mesh)
1.6.5	5018265	1	80 Degree Flat Spray Tip, Yellow
1.6.6	5046219	1	Quick TeeJet Cap (Yellow)
1.7	5275340	1	(R.H.) Single Deluxe Nozzle Assembly

Item	Part No.	Qty	Description
1.7.1	5002490	1	Quick TeeJet Nozzle, 1/2" Single - Right
1.7.2	5006087	1	Brass Nut for Quick TeeJet Nozzles
1.7.3	5016157	1	Seat Washer (QJ Caps)
1.7.4	5116019	1	Nozzle Strainer, Red (50 Mesh)
1.7.5	5046219	1	Quick TeeJet Cap (Yellow)
1.7.6	5018265	1	80 Degree Flat Spray Tip, Yellow
2	5274770	1	Boom Assembly
2.1	5006345	4	3/8"-16 Flange Locknut (Grade F)
2.2	5006092	4	3/8"-16 Hex Locknut
2.3	5006259	5	3/8"-16 Hex Whiz (Flange) Locknut
2.4	5274518	1	Center Boom Weldment
2.5	5274519	1	Outer Boom Weldment (L.H.)
2.6	5274520	1	Outer Boom Weldment (R.H.)
2.7	5019228	2	Extension Spring
2.8	5038651	1	Boom Holder Bracket
2.9	5016030	8	Flatwasher, 3/8"
2.1	5034482	5	Carriage Bolt, 3/8"-16 x 1"
2.11	5034524	4	Carriage Bolt, 3/8"-16 x 1 1/4"
2.12	5003526	2	Rubber Edge Trim

Figure A

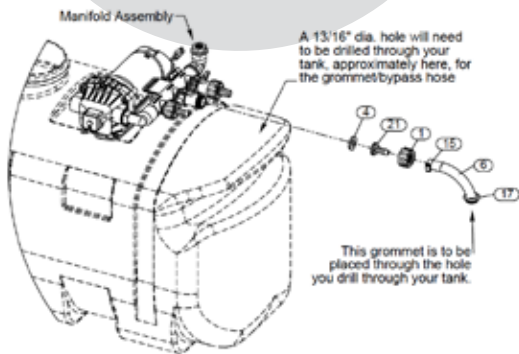

With your pump mounted on the 'top' of your tank, this is how your bypass line will be configured.

Tip No.	Spray Height	Pressure (psi)	Capacity (GPM)	Gallons Per Acre - Based on Water						
				1MPH	2MPH	3MPH	4MPH	5MPH	7.5MPH	10MPH
2	18"	20	.14	41.8	20.9	14.0	10.5	8.4	5.6	4.2
		30	.17	51.2	25.6	17.2	12.9	10.3	6.9	5.1
		40	.20	59.2	29.6	19.8	14.9	11.9	7.9	5.9
		50	.23	66.4	33.2	22.2	16.6	13.3	8.8	6.6
Tip no.	Spray Height	Pressure (psi)	Capacity (GPM)	Gallons Per 1000 Sq. Ft. - Based on Water						
				1MPH	2MPH	3MPH	4MPH	5MPH	7.5MPH	10MPH
2	18"	20	.14	.96	.48	.32	.24	.19	.13	.10
		30	.17	1.18	.59	.39	.30	.24	.16	.12
		40	.20	1.36	.68	.45	.34	.27	.18	.14
		50	.23	1.52	.76	.51	.38	.31	.20	.15
Tip No.	Spray Height	Pressure (psi)	Capacity (GPM)	Gallons Per 100 Sq. Ft. - Based on Water						
				1MPH	2MPH	3MPH	4MPH	5MPH	7.5MPH	10MPH
2	18"	20	.14	.096	.048	.032	.024	.019	.013	.010
		30	.17	.118	.059	.039	.030	.024	.016	.012
		40	.20	.136	.068	.045	.034	.027	.018	.014
		50	.23	.152	.076	.051	.038	.031	.020	.015

SPRAYER PARTS & ACCESSORIES



PUMPS



Shurflo Pumps

ATV City Part No.	Description
52510	Pump 8002 4.6 L/min open flow 40-60 PSI Shurflo P/N 8000-542-136
52515	Pump 8003 6.8 L/min open flow 80-100 PSI Shurflo P/N 8000-543-138
81148	Pump 2038 11.2 L/min open flow 30-45 PSI Shurflo P/N 2088-343-135

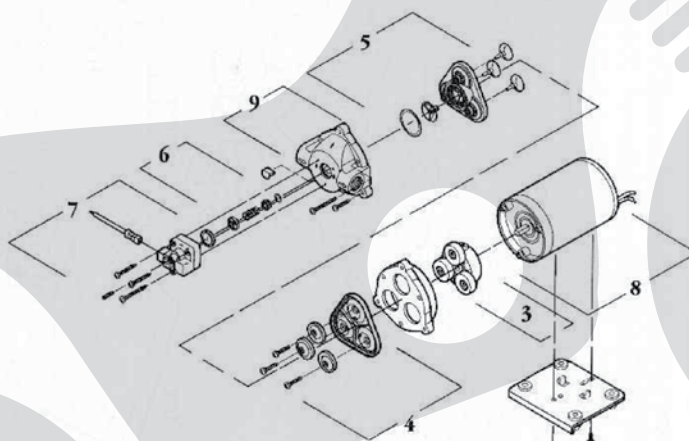

C-DAX Part No	Used On	Model	Pressure Switch Kit (7)	Check Valve Kit (6)	Upper Housing (9)	Valve Kit (5)	Diaphragm Kit (4)	Drive Kit (3)	Motor (8)	Motor Brush kit
52510	SR50/80	8002 B	94-375-06	94-374-05	94-378-00	94-390-05	94-385-31		11-111-00	94-004-01
52515	SR53/83	8003 B	94-375-18	94-374-05	94-378-00	94-390-05	94-385-32		11-111-00	94-004-01
81148	SR58/88	2038B	94-230-36	94-237-05	94-231-30	94-232-05	94-238-03		11-111-00	94-004-01

Flojet Pumps



Item	ATV City Part No.	Description
	950.6800-4000	Complete Motor 3.8L/min open flow pump
1	950.6800-4040	Pressure Switch Kit
2	950.6800-4030	Pumphead Kit (includes pressure switch)

SPRAYER PARTS & ACCESSORIES



PUMPS



Fimco Pumps

ATV City Part No.	Description
352.5275086	1 GPM pump (3.8 L/min) open flow
352.5275087	2.1 GPM pump (7.94 L/min) open flow
352.5275088	3.8 GPM pump (14.38 L/min) open flow

HAND LANCES



Lances

ATV City Part No.	Description
950.4000-3900	HG2 Pistol Spray Gun
950.4000-5000	Hand Lance C-DAX Sprayrider Type (stainless steel lance) - comes with flat fan tip, optional brass adjustable tip P/N 60027
950.4000-6020	Hand Lance Quadmate Type complete with adjustable tip
352.5163100	Hand Lance Fimco Type
352.5273959	Hand Lance - FMCO Deluxe X-26



CITY[®]

the best part of your atv



16: C-DAX PRODUCTS



SprayRider™

Designed and engineered specifically for the ATV, SprayRider™ features unique safety features such as low centre of gravity and internal tank baffles dramatically reduce the destabilising effect of liquid surge while the ATV is in motion. Patented valves eliminate the underbody balance hose but preserve the unique C-Dax feature of total evacuation of tank contents on all terrain. A two litre on-board fresh water tank provides a handy reservoir to rinse hands on the SprayRider™ 50 & 80, and doubles as a hose storage feature, while the robust lance with adjustable nozzle caters for a range of different jobs.

The convenient handlebar mounted on/off switch allows for ease of use and increases operator safety.

Front or rear mounting alternatives for SprayRider™ 50 & 80 (depending on bike) ensure that more control can be exercised over the critical consideration of weight distribution, while the Dual Tank Kit allows increased carrying capacity without compromising stability.

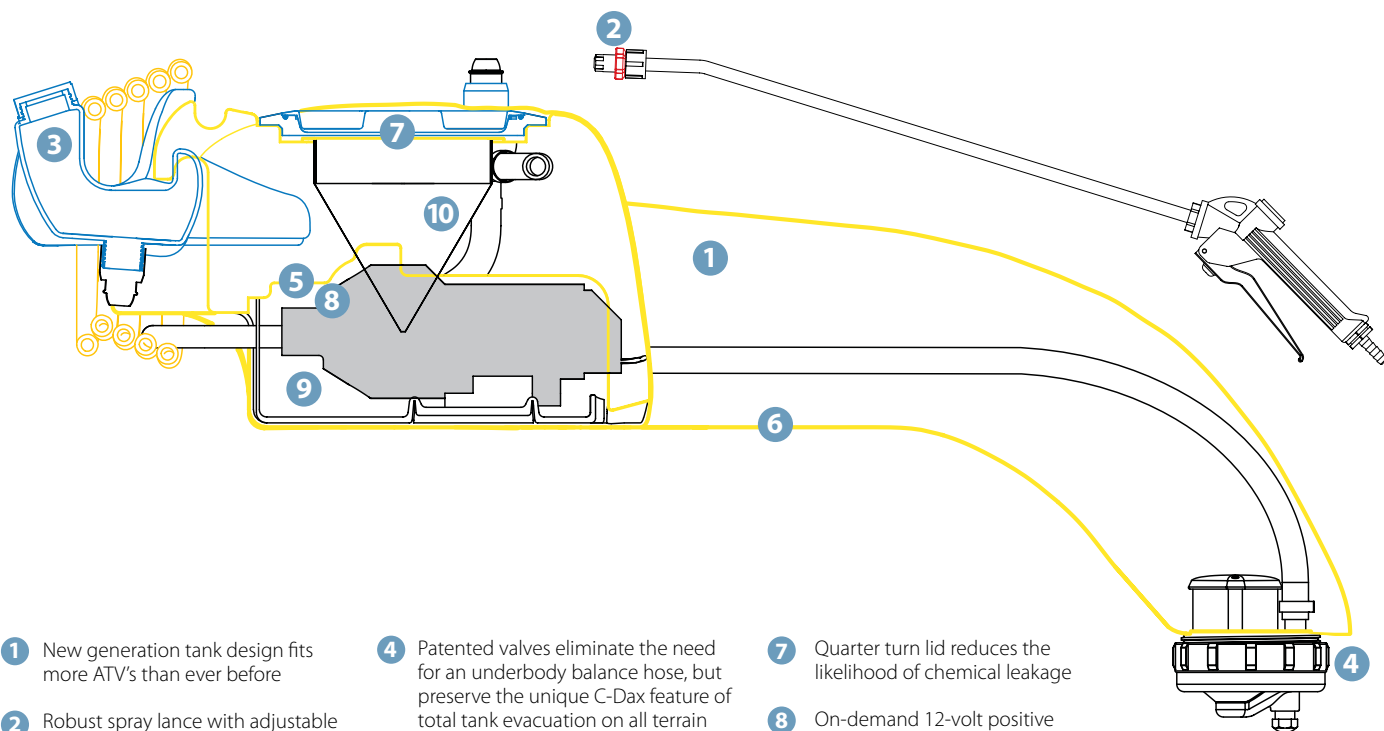

- 1** New generation tank design fits more ATV's than ever before
- 2** Robust spray lance with adjustable nozzle to cater for different jobs
- 3** Two litre on-board fresh water tank provides a reservoir to rinse hands and doubles as a hose storage feature
- 4** Patented valves eliminate the need for an underbody balance hose, but preserve the unique C-Dax feature of total tank evacuation on all terrain
- 5** Deep one-piece baffle reduces liquid surge, especially on steep terrain
- 6** Low centre of gravity for enhanced operator safety
- 7** Quarter turn lid reduces the likelihood of chemical leakage
- 8** On-demand 12-volt positive displacement diaphragm pump
- 9** Pump cover protects electrics
- 10** Multiple filters minimise nozzle blockages



SprayRider™ 50 & 80

SPECIFICATIONS:

- 50 Litre front or rear mounting (depending on bike).
Weight: 12.5kg empty; 62.5kg full
- 80 Litre rear mounting only
Weight: 13.5kg empty; 93.5kg full
- 580psi, 8mm delivery hose
- 12-volt DC pump connects to ATV battery
- 7.6Lpm (60psi) pump

COMES WITH:

- 10m of delivery hose and rugged spray lance
- Wiring loom with fuse and handlebar mounted on/off switch
- Ratchet tie-down strap
- 2 Litre fresh water tank



Dual Tank Kit 50 & 80

SPECIFICATIONS:

- 50 Litre front or rear mounting (depending on bike)
Weight: 10kg empty; 60kg full
- 80 Litre rear mounting only
Weight: 11kg empty; 90kg full
- 13mm feed pipe

COMES WITH:

- Feed pipe and dry break connectors
- Isolator valves
- Ratchet tie-down strap
- 2 Litre fresh water tank



1. The safest ATV sprayer—ever!

Lowest centre of gravity available in an ATV sprayer. Internal baffle prevents sudden liquid movement when in motion.

2. Complete tank evacuation

'Smart' suction valves ensure complete tank evacuation on any angle.

3. On-board two litre fresh water reservoir

(SPRAYRIDER™ 50 & 80 ONLY)
Provides a tank to rinse hands or components. Doubles as storage for the spray hose.

4. Pump cover to prevent damage

Cover protects the pump from damage and the elements.

OPTIONS AVAILABLE		WARNING: DO NOT EXCEED THE MAXIMUM WEIGHT LOADING RECOMMENDED BY THE ATV MANUFACTURER
PART NO	DESCRIPTION	£RRP + VAT
1001	SprayRider™ 50	£625.00
1002	SprayRider™ 80	£650.00
1003	Dual Tank Kit 50	£405.00
1004	Dual Tank Kit 80	£420.00



CDA BOOM NOT INCLUDED

Spray-On 200

The Spray-On 200 showcases the latest in Generation 2 styling and design innovations at a price you can afford. Whether you need a spot sprayer, flatdeck or boom sprayer, the Spray-On 200 has the flexibility to suit your requirements.

Trailed sprayers are subject to various forces generated by the dynamic effect of liquid in motion. These forces need to be isolated at the trailer and not transferred to the vehicle. To ensure the stability of the vehicle is not compromised, the Spray-On 200 trailed is well balanced, in proportion and has a low centre of gravity. The single axle is robust in construction and individually sprung to minimise shock transfer to the vehicle. As trailed sprayers are often used when conditions are too wet to permit access with heavier equipment, the Spray-On 200 trailed is fitted with mudguards as standard.

The uniquely designed shape of the Spray-On 200 ensures that it can perform well in a flat deck situation, remaining stable and withstanding the rigours of intensive use while remaining lightweight and easy to handle to ensure the tank is readily transportable.

An easily accessible moulded two litre fresh water handwash tank will help you to clean up after spraying.



TRAILED



FLATDECK

SPECIFICATIONS:

- Weight (tank) 29kg empty; 229kg full (Flatdeck option)
- 580psi, 8mm delivery hose
- Dimensions:
length 820mm;
width 740mm;
height 475mm (Flatdeck tank only)

COMES WITH:

- 7.6Lpm (60psi) internal bypass pump
- 10m of delivery hose
- Wiring loom with on/off switch
- Stainless steel spray lance

CONFIGURE:

- Tyres—turf or knobbly
- Booms (see pages 7–9)

1. Low profile tank for greater stability

Ensures low centre of gravity for maximum vehicle stability on uneven terrain.

2. Tank sump

Chemical is evacuated from a unique sump in the bottom of the tank.

3. Covered pump

Recessed chamber provides maximum pump protection.

4. Heavy-duty steel frame

(TRAILED ONLY)

For maximum strength Superior C-Dax suspension provides a stable spraying platform.

5. Moulded contents scale

Allows operator to easily gauge tank contents.

6. Fresh water handwash tank

Easy clean up and doubles as hose and lance storage.

OPTIONS AVAILABLE

WARNING: DO NOT EXCEED THE MAXIMUM WEIGHT LOADING RECOMMENDED BY THE ATV MANUFACTURER

PART NO	DESCRIPTION	ERRP + VAT
1086	Spray-On 200 Flat Deck	£695.00
4500-9310	Trailer kit to suit Spray-On 200 tank	£1095.00



12-VOLT MODEL—CDA BOOM NOT INCLUDED



ENGINE DRIVEN MODEL

Spray-On 400

The C-Dax Spray-On 400 is available as a flatdeck or trailed sprayer and comes as a 12-volt or high pressure engine driven pump configuration. The modular design means that there is a Spray-On 400 flexible solution to your spraying requirements.

Trailed sprayers are subject to various forces generated by the dynamic effect of liquid in motion. These forces need to be isolated at the trailer and not transferred to the vehicle. To ensure the stability of the vehicle is not compromised, the Spray-On 400 trailed is well balanced, in proportion and has a low centre of gravity. The single axle is robust in construction and individually sprung to minimise shock transfer to the vehicle. As trailed sprayers are often used when conditions are too wet to permit access with heavier equipment, the Spray-On 400 trailed is fitted with mudguards as standard.

The sturdy mounting frame ensures maximum protection for the tank from impact and abrasion.

SPECIFICATIONS:

- Weight:
12-Volt Flat Deck—115kg empty; 515kg full
- Dimensions:
12-Volt Trailed—length 2000mm; width 1580mm; height 1050mm
Flatdeck—length 1700mm; width 965mm; height 754mm

COMES WITH:

- Pump (12-volt or engine driven)
- 10m of 580psi/10mm delivery hose and robust spray lance (12-volt models only)
- Wiring loom with on/off switch (12-volt models only)
- Mudguards and knobby tyres

CONFIGURE:

- Booms (see pages 7-9)
- Hose reels (see page 10)



400 LITRE TRAILED WITH OPTIONAL CDA BOOM (SEE PAGE 10)

1. Sturdy mounting frame

Protects tank from impact and abrasion.

2. Low profile tank for greater stability

Ensures low centre of gravity for maximum vehicle stability on uneven terrain.

3. Tank sump

Chemical is evacuated from a unique sump in the bottom of the tank.

4. Covered pump

Recessed chamber provides maximum pump protection (12-volt models only).

5. Moulded contents scale

Allows operator to easily gauge tank contents.

OPTIONS AVAILABLE		WARNING: DO NOT EXCEED THE MAXIMUM WEIGHT LOADING RECOMMENDED BY THE ATV MANUFACTURER
PART NO	DESCRIPTION	£RRP + VAT
1092	Spray-On 400 Flat Deck	£1450.00
4500-9300	Trailer kit to suit Spray-On 400 tank	£1350.00



SPRAYRIDER™ AND BOOM NOT INCLUDED

Eliminator Weed Wiper

The C-Dax Eliminator trailed weed wiper dramatically reduces damage to your pasture by putting chemical on the weeds rather than the whole pasture. Quality C-Dax construction means an extremely robust, trailed weed wiper designed to control weeds while preserving pasture. The electronic chemical flow controller allows operators to quickly adjust the amount of chemical being pumped to the wiping carpets to suit the level of infestation. A pressurised feed system ensures equal amounts of chemical are pumped to either side of the wiper regardless of the angle of operation.

The new Winged Eliminator gives an impressive overall width of 4.30m to save you even more time and allows easy control of weeds on banks and edges of waterways without the risk of runoff or spraydrift.

SPECIFICATIONS:

- Wiping width: Eliminator 2.3m;
Winged Eliminator 4.3m
- Self-angling wings with dual or independent left and right wing operation
- Application rates between 3.9–40.2L/ha
- Four height settings, from 85–385mm (approx)
- Floating wings sledge height on ends 150mm
- Angled woollen wiper arms for maximum contact and efficiency
- Patented feed system for even chemical distribution on the roughest terrain
- Weight: 70kg (Eliminator)

COMES WITH:

- 4m of delivery hose
- Electronic flow rate controller
- Dry break couplers and plumbing kit

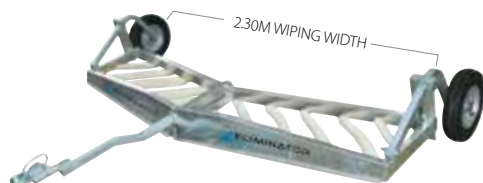

ELIMINATOR

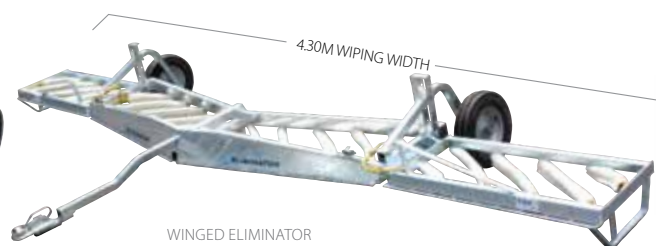

WINGED ELIMINATOR



OPTIONAL ON-BOARD TANK

1. Electronic flow controller included

Allows application rate adjustment while wiping.

2. Pressurised chemical feed system

Ensures even quantities of chemical are pumped to all wiping areas.

3. Angles wiping carpets

Specifically angled wiper arms rotate the weed for better chemical coverage.

4. Heavy-duty galvanised frame

For maximum strength and corrosion resistance.

5. Front mounted 'bruise' bar

Scrapes the weed stem for faster chemical absorption.

OPTIONS AVAILABLE		WARNING: DO NOT EXCEED THE MAXIMUM WEIGHT LOADING RECOMMENDED BY THE ATV MANUFACTURER
PART NO	DESCRIPTION	£RRP + VAT
1015	Eliminator	£1695.00
1016	Winged Eliminator	£2650.00
1017	Eliminator Tank 50L(pump included)	£395.00
4500-9350	Wing Extensions to suit Standard Eliminator (must be a model with extension brackets added)	£1150.00



SPRAYRIDER™ AND QUICKSMART™ FRAME NOT INCLUDED

MultiBoom

The MultiBoom is a pressure nozzle spray boom featuring independent nozzle control that allows operators to easily adjust the overall spray width from 1.5–4.5m. The compact, robust design make it a popular choice among many of today's farmers and growers.

SPECIFICATIONS:

- 10mm, 580psi delivery hose
- Boom width: 1500mm
- Boom Weight: 8kg

COMES WITH:

- 2.5m of delivery hose
- Nozzle isolator valves
- Dry break couplers and plumbing kit
- Non-drip diaphragm check valves

3 & 4m Booms

C-Dax folding spray booms incorporate a number of practical features such as breakaway and non-drip nozzles. Two sizes are available to suit any weed management programme.

SPECIFICATIONS:

- 110° wide range spray tips as standard
- 500mm nozzle spacing
- 10mm, 580psi delivery hose
- Boom weights: 3m: 9kg; 4m: 12kg
- Spring loaded self-centering breakaway arms

COMES WITH:

- 3m of delivery hose
- Dry break couplers and plumbing kit
- Non-drip diaphragm check valves



MULTIBOOM
(SPRAYRIDER™ & QUICKSMART™ FRAME NOT INCLUDED)



3M BOOM
(SPRAYRIDER™ & QUICKSMART™ FRAME NOT INCLUDED)

1. Fit and remove in seconds

Unique QuickSmart™ Attachment frame (optional) allows operators to fit or remove booms in seconds—no nuts, bolts, or spanners!
(See page 11 for details)

2. Non-drip nozzles with built in protection

Diaphragm check valves prevent dripping and shrouds to protect against impact damage.

3. Independent nozzle on/off valves (MULTIBOOM ONLY)

Individual nozzles can be turned off to vary the spraying width from 1.5–4.5m. Adjustable off-set nozzles make the MultiBoom ideal for spraying culverts or drains.

4. Simple height adjustment

Ensures optimum spraying height is able to be maintained.

OPTIONS AVAILABLE		WARNING: DO NOT EXCEED THE MAXIMUM WEIGHT LOADING RECOMMENDED BY THE ATV MANUFACTURER
PART NO	DESCRIPTION	£RRP + VAT
1018	MultiBoom (See page 11 for Quicksmart™ Attachment options)	£235.00
4500-1050	Standard type mounting system for MultiBoom	£60.00
1019	3m Boom (See page 11 for Quicksmart™ Attachment options)	£470.00
1020	4m Boom (See page 11 for Quicksmart™ Attachment options)	£525.00



Controlled Droplet Application (CDA)

Pioneered in New Zealand by C-Dax Ltd, CDA technology works by eliminating the large droplets, which contain the most chemical and are prone to “run-off” and exercising similar control over finer droplets which are prone to drift, Controlled Droplet Application (CDA) enables farmers and growers to cover a vastly greater area with smaller tank capacity, thereby vastly reducing fill and mix times.

From an environmental perspective, CDA offers the advantage of reducing ground contamination and spray drift.

Many farmers and growers who have used CDA for a number of years observe that they are able to maintain improved control because CDA offers a larger “spraying-window” than conventional pressure nozzle technology.

Research reports suggest strongly that there is an optimum droplet size for spraying. CDA generates droplets which fall almost entirely within the ideal spectrum for optimum cover, while limiting run-off and spray drift.

Each CDA “Rotary Atomiser” can be adjusted to generate an optimum droplet size for the task being undertaken at the time. Reliable and low maintenance, CDA will provide your farming operation with increased efficiency and effective use of chemical.

ABOVE: UNIFORM DROPLETS CREATED FROM THE CDA ATOMISER

BELOW: RANDOM DROPLETS FROM PRESSURE NOZZLE SPRAYER

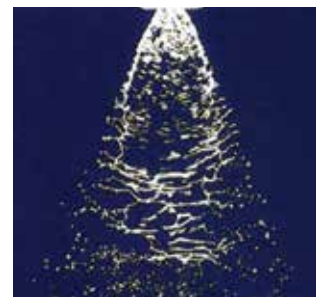

Conventional Spraying vs CDA Spraying

CONVENTIONAL SPRAYING

Goldline 800L with
8m pressure nozzle boom

97L/ha

One tank=8ha



CDA SPRAYING

C-Dax Spray-On 200L with
3.6m CDA boom

27L/ha

One tank=8ha



**FOLLOW LEADING
CHEMICAL
MANUFACTURERS
CDA APPLICATION
RATES**



SPRAYRIDER™ NOT INCLUDED



CDA Booms

CDA offers considerable advantages over conventional pressure nozzle spray booms. This advanced technology significantly reduces off target movement delivering reduced chemical costs and less time.

SPECIFICATIONS:

- 1.8m spraying width per atomiser
- 580psi, 10mm delivery hose
- Boom weights: 3.6m model: 12kg; 5.4m model: 32kg

COMES WITH:

- 6m of delivery and bypass hose
- Dry break couplers and plumbing kit
- Wiring loom and on/off control box
- Pressure regulator



CDA 5.4M BOOM ONLY
(FOR 400L SPRAYER SEE PAGE 5)

1. Reduced spray drift and run off

Optimum size droplets less likely to run off or drift.

2. Easy to calibrate

Simple three step calibration process:

1. Determine forward speed
2. Fit correct flow plate
3. Adjust pressure

3. Boom breakaway protects spray heads

Protects CDA atomisers from horizontal impact damage.

Amenity Boom

The C-Dax Amenity kit is perfect for Councils or Contractors for the spraying of roads, kerbs or fields.

THIS KIT COMES COMPLETE WITH:

- Height adjustable front mounted boom with 3 non-drip nozzles with up to 1.5 metre coverage and L/H and R/H Foot Peg nozzles with swivel heads.
- Triple Diverter valve with pressure gauge and 3 outlet taps: L/H Footpeg Nozzle, Centre Boom and R/H Footpeg Nozzle. Includes Hose and Fittings.



OPTIONS AVAILABLE		WARNING: DO NOT EXCEED THE MAXIMUM WEIGHT LOADING RECOMMENDED BY THE ATV MANUFACTURER
PART NO	DESCRIPTION	ERRP + VAT
1021	CDA boom 3.6m (See page 11 for Quicksmart™ Attachment options)	£1150.00
1022	CDA boom 5.4m (See page 11 for Quicksmart™ Attachment options)	£2030.00
2025	Amenity Boom Kit (comes with Quicksmart Attachment frame and boom mounts)	£395.00
2014	Tripple Diverter Valve Kit	£220.00



SPRAY GUN



T-JET LANCE

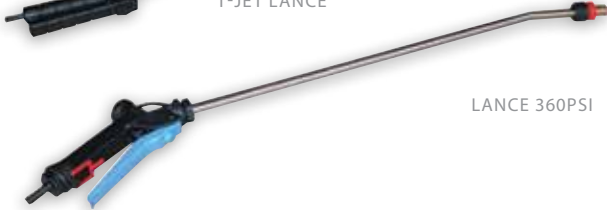

LANCE 360PSI

Lances and Spray Guns

Renowned for their quality and reliability, C-Dax lances and spray guns are available in a range of options to suit any spraying operation. Manufactured from high quality materials to ensure maximum strength and reliability, and longevity. Also compatible with a wide variety of nozzle tips for correctly matching the output of your pump.

SPECIFICATIONS:

- Lances rated from: 45–360psi (3.1–25 Bar)
- Spray guns rated from: 725–800psi (50–55 Bar)

COMES WITH:

- Hose tail
- Nozzle tip

1. High strength

Manufactured from high quality materials for maximum strength and reliability.

2. Compatible with any sprayer

A wide variety of nozzle tips ensure your choice of lance or spray gun can be correctly matched to the output of your pump.

OPTIONS AVAILABLE		
WARNING: DO NOT EXCEED THE MAXIMUM WEIGHT LOADING RECOMMENDED BY THE ATV MANUFACTURER		
PART NO	DESCRIPTION	ERRP + VAT
4000-6020	T-Jet Lance 100psi	£30.00
4000-5000	Lance 360psi HGSR	£39.75
4000-5026	Brass Adjustable Nozzle to suit HGSR	£8.95
4000-3900	Spray Gun 800psi HG2, 1.5mm tip	£95.00



3.8LPM



7.6LPM

12-Volt Pumps

Flojet pumps are recognised for their quality and reliability. Available as 60 or 45 psi pumps.

SPECIFICATIONS:

- 7.6Lpm (60psi) or 3.8Lpm (35psi)
- 3.8Lpm comes complete with 10mm hosetails

1. Reliable, high quality pumps

High quality components ensure longevity and reliability.

OPTIONS AVAILABLE		
WARNING: DO NOT EXCEED THE MAXIMUM WEIGHT LOADING RECOMMENDED BY THE ATV MANUFACTURER		
PART NO	DESCRIPTION	ERRP + VAT
6800-5000	Flojet Pump 7.6Lpm (60psi)	£165.00
6800-4000	Flojet Pump 3.8Lpm (35psi)	£105.00

25M POLY



100M STEEL



50M POLY



Hose Reels

C-Dax manufactures a wide variety of quality hose reels. An extensive range of mounting options enables them to be easily attached to your existing sprayer. Manufactured from high strength zinc plated steel or polyethylene to ensure maximum strength and longevity. Design features such as an extra wide handle make for easy winding.

SPECIFICATIONS:

- Rated to: 365psi (25 bar)
- 10mm hose fittings
- 25, 50 or 100

COMES WITH:

- Plumbing Kit
- 2m of delivery hose (to connect reel to existing sprayer)

OPTIONS AVAILABLE		
WARNING: DO NOT EXCEED THE MAXIMUM WEIGHT LOADING RECOMMENDED BY THE ATV MANUFACTURER		
PART NO	DESCRIPTION	ERRP + VAT
1057	Hose reel (Polyethylene), 25m	£229.00
1058	Hose reel (Polyethylene), 50m	£295.00
1059	Hose reel (Steel), 100m	£325.00



QUICKSMART™ FOR SPRAY BOOM



QUICKSMART™ FOR SPREADER

QuickSmart™ Attachment System

C-Dax's QuickSmart™ Attachment Frame and Upright Mounts are a universal mounting system that allows implements to be inter-changed without the need for nuts, bolts and spanners.

The QuickSmart™ Attachment Upright Mounts for Sprayers allows you to easy attach your C-Dax boom to your QuickSmart™ Attachment Frame on your ATV in seconds.

The QuickSmart™ Attachment Upright Mounts for Spreaders allows you to easy attach your C-Dax SpreadMaster and SlugMaster to your QuickSmart™ Attachment Frame on your ATV in seconds.

SPECIFICATIONS:

- Attachment Frame:
5mm steel frame;
weight: 6kg

COMES WITH:

- ATV mounting brackets
and fittings

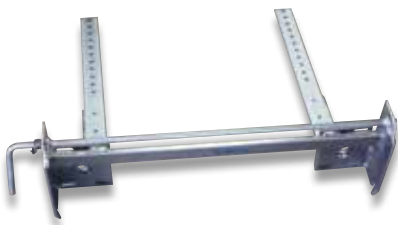

QUICKSMART™ ATTACHMENT
FRAME



QUICKSMART™ ATTACHMENT
UPRIGHT MOUNTS FOR
BOOMS



QUICKSMART™ ATTACHMENT FRAME TO
SUIT UTVS



QUICKSMART™ ATTACHMENT
UPRIGHT MOUNTS FOR
SPREADERS

1. Change implements without nuts, bolts or spanners!

Unique 'latch' design enables compatible products to be fitted or removed in seconds.

2. Fits any ATV

Universal attachment brackets ensure the QuickSmart™ frame will fit any ATV!

OPTIONS AVAILABLE		WARNING: DO NOT EXCEED THE MAXIMUM WEIGHT LOADING RECOMMENDED BY THE ATV MANUFACTURER
PART NO	DESCRIPTION	£RRP + VAT
1073	QuickSmart™ Attachment Frame	£132.00
1074	QuickSmart™ Attachment Upright Mounts for booms only	£30.00
1113	QuickSmart™ Attachment Frame – To Suit UTV's Universal Fitting	£115.00
3008	QuickSmart™ Attachment Upright Mounts for Spreaders Only	£60.00

Tip Calibration Guide

TIP REF CODE	PRESSURE (BAR)	FLOW L/MIN	6KPH	8KPH	L/HA 10KPH	12KPH	14KPH
110-WR-01 Orange	1.0	0.23	46	35	28	23	20
	1.5	0.28	57	43	33	28	24
	2.0	0.33	66	50	40	33	28
	2.5	0.37	74	56	44	37	32
	3.0	0.40	80	60	48	40	34
	3.5	0.43	86	65	52	43	37
	4.0	0.46	92	69	55	46	39
110-WR-015 Green	1.0	0.35	70	53	42	35	30
	1.5	0.42	84	63	50	42	36
	2.0	0.49	98	74	59	49	42
	2.5	0.55	110	83	66	55	47
	3.0	0.60	120	90	72	60	51
	3.5	0.65	130	98	78	65	56
	4.0	0.69	138	104	83	69	59
110-WR-02 Yellow	1.0	0.46	92	69	55	46	39
	1.5	0.56	112	84	67	56	48
	2.0	0.65	130	98	78	65	56
	2.5	0.73	146	110	88	73	63
	3.0	0.80	160	120	96	80	69
	3.5	0.86	172	129	103	86	74
	4.0	0.92	184	138	110	92	79
110-WR-03 Blue	1.0	0.69	138	104	83	69	59
	1.5	0.85	170	128	102	85	73
	2.0	0.98	196	147	118	98	84
	2.5	1.10	220	165	132	110	94
	3.0	1.20	240	180	144	120	103
	3.5	1.30	260	195	156	130	111
	4.0	1.39	278	209	167	139	119

1. Wide Range Tip as standard

C-Dax uses the Wide Range tip as standard

2. Backed by people who care about their customers

All C-Dax products are supported by people who care about their customers, and come complete with a 12 month warranty.





SpreadMaster

The C-Dax SpreadMaster is a versatile general purpose 12-volt broadcast spreader that is suitable for a wide range of spreading and seeding applicators.

Features a simple and effective shutter system with delivery rate and spread centering controls. With a 70 litre capacity and a spread width of 15m (based on Urea at 10kph) the SpreadMaster ensures you can get your job done quickly and efficiently.

Easily mounted on the back of your ATV using the C-Dax Quick Smart Frame system (see page 11 for details).



SPECIFICATIONS:

- 12-volt
- 70 Litre capacity hopper (60kg Urea)
- 15m spread width (Urea at 10kph)
- Applies up to 50kg/ha (Urea at 10kph)
- Weight: 28kg empty

COMES WITH:

- Wiring loom
- Remote mounting on/off switch
- Snap shut hopper lid

NB: For QuickSmart™ Attachment for SpreadMaster see page 11.

1. Fit and remove in seconds

Unique QuickSmart™ Attachment Frame allows operators to fit or remove QuickSmart™ compatible versions in seconds—no nuts, bolts or spanners!

2. Heavy-duty steel frame

Featuring extra bracing for optimum strength and rigidity and is galvanised for maximum corrosion protection.

3. Reliable 12-volt motor

Industrial strength 12-volt motor is powerful and reliable.

4. Unique spinner disc design

Ensures a wider and more even broadcast pattern.

OPTIONS AVAILABLE		WARNING: DO NOT EXCEED THE MAXIMUM WEIGHT LOADING RECOMMENDED BY THE ATV MANUFACTURER
PART NO	DESCRIPTION	£RRP + VAT
3000	SpreadMaster (See page 11 for Quicksmart™ Attachment options)	£825.00



SlugMaster

The C-Dax SlugMaster is a heavy-duty 12-volt broadcast spreader that has been specifically developed for spreading bait in arable cropping situations.

Features a spread pattern up to 24m wide for maximum coverage and efficiency. Reliable and ready to go when you need it, easily attached to your flat deck vehicle, or ATV using the C-Dax QuickSmart™ Attachment Frame system (see page 11 for details).

SPECIFICATIONS:

- 12-volt
- 75 Litre capacity hopper
- Up to 24m spread width
- Applies 2.5–20 kg/ha
- Five application rate settings
- Weight: 30kg empty

COMES WITH:

- Wiring loom
- Remote shutter gate and spinner operation
- Snap shut hopper lid



NB: For QuickSmart™ Attachment for SlugMaster see page 11.

1. Fit and remove in seconds

Unique QuickSmart™ Attachment Frame allows operators to fit or remove QuickSmart™ compatible versions in seconds—no nuts, bolts or spanners!

2. Heavy-duty steel frame

Featuring extra bracing for optimum strength and rigidity and is powder coated for maximum corrosion protection.

3. Remote spinner disc and shutter control

Allows the operator to control both the spinner disc and shutter gate without leaving the cab.

OPTIONS AVAILABLE

WARNING: DO NOT EXCEED THE MAXIMUM WEIGHT LOADING RECOMMENDED BY THE ATV MANUFACTURER

PART NO	DESCRIPTION	£RRP + VAT
3001	SlugMaster (See page 11 for QuickSmart™ Attachment options)	£865.00



BoxMate

The C-Dax BoxMate is a robust and convenient storage box for easily keeping all your tools together and ensuring that you can perform any job or maintenance on the farm in a timely manner.

Easily attached to the front or back of your ATV with the mounting hooks.

The BoxMate also features a one litre on-board fresh water storage tank moulded into the box so that you will always have water on hand to clean up with.

SPECIFICATIONS:

- BoxMate
Length 780mm;
Width = 370mm;
Height = 200mm;
Weight: 6kg
- Moulded in 1.5Litre fresh water tank

COMES WITH:

- Zinc plated mounting hooks and wingnut fasteners



1. Two internal trays

Internal trays to store staples/nails, tools and other useful items.

2. Hand wash tank

Unique one litre on-board fresh water tank is ideal for rinsing hands or components

OPTIONS AVAILABLE

WARNING: DO NOT EXCEED THE MAXIMUM WEIGHT LOADING RECOMMENDED BY THE ATV MANUFACTURER

PART NO	DESCRIPTION	ERRP + VAT
7001	BoxMate	£159.00

ATV Carrier Mat

C-Dax's ATV carrier mat is a solid ATV mounting mat that provides stable footing for dogs, and a non-slip base for other loads while protecting your ATV.

SPECIFICATIONS:

- Length: 1200mm; Width: 520mm
- 18mm thick rubber
- Weight: 14kg



1. Non-slip surface

Textured non-slip surface provides a good footing for dogs.

2. Protect your investment

Protects the rear of the ATV seat against sharp claws, and the carrier from dents and scrapes. Maintains the value of your ATV.

OPTIONS AVAILABLE

WARNING: DO NOT EXCEED THE MAXIMUM WEIGHT LOADING RECOMMENDED BY THE ATV MANUFACTURER

PART NO	DESCRIPTION	ERRP + VAT
120-71655	ATV Carrier Mat	£37.50



Spotlight

An all-purpose adjustable spotlight for ATV. Includes cigarette plug for easy charge from cigar-lighter.

DESIGNED TO CARRY

- Dimension: 160x170x157mm
- Clear lens
- Buckets
- Bulb: H3 12V 35W Bulb
- Main wire with cigarette terminal
- Black steel stand
- Body: Black



Gun Rack

Universal fitting gun rack fits any types of ATV'S, UTV'S and is designed to carry guns, bows and fishing rods securely on handle bars, front or rear racks

Part No - 120.0300



Universal Fitting Windscreen

Made from lexan polycarbonate with a protective rubber trim edge for maximum durability

Part No - 120.0200 ATV Universal windscreen
120.0210 ATV Universal Windscreen with headlight cut out



Mud Flap Kits

Universal Mounting Mudflap Kit - comes complete with steel mounting kit and hard rubber flaps

Part No - 145.0100 Universal ATV Mud Flap Kit

For pricing on the above contact your local C-Dax dealer

C-DAX (ATV City) TERMS OF TRADE – SUMMARY

1. PRICES

C-Dax (ATV City) reserves the right to change prices and specifications without notice. All prices are subject to VAT.

2. WARRANTY

C-Dax (ATV City) warrants that the goods sold are free from defects in materials, mechanical parts and workmanship. Accordingly, C-Dax (ATV City) undertakes to repair, or at our option replace, without cost to such original purchaser either for material, parts, or labour, any part which within the specified warranty period from time of delivery is found to be defective PROVIDED that the equipment has been used for the purposes intended by the manufacturer in accordance with the instructions and has not been subject to neglect, misuse or accident and has not been repaired, serviced or dismantled by any person other than a service agent authorised by C-Dax (ATV City). This warranty does not extend to cover repair or replacement of moving parts due to normal fair wear and tear arising from use. Specifically, the warranty excludes chemical attack, battery damage and goods built to customer's specifications. NB: All warranty goods to be returned to C-Dax (ATV City) with freight paid by the sender. An allowance has been included in dealer entitlements to cover the wholesale cost of Labour, travelling time and consumables used for warranty claims. Such costs will not normally be separately reimbursed.

3. MAXIMUM LIABILITY

The maximum liability which is accepted by C-Dax (ATV City) is limited to repair or replacement of faulty goods only. Under no circumstances will be liable for any indirect or consequential loss whatsoever. In the manufacture of our goods, every care has been taken but as the use of the goods is outside the control of the manufacturer, the end user assumes all responsibility for the use of the goods and neither the manufacturer nor any distributor or retailer shall be liable for any loss or damage resulting from use. Any advice or recommendations given by us or our staff is given in good faith and based on the best information available to us but neither we nor our staff accept liability arising from following that advice. The end user takes all responsibility for any action arising from that advice.

4. DELIVERY OF GOODS

Delivery shall be deemed complete when C-Dax (ATV City) gives possession of the goods to a carrier for delivery to the Purchaser. C-Dax (ATV City) shall not be liable for any damage or loss whatsoever arising from any failure to deliver or delay in delivery of the goods caused by an event beyond our control. The Purchaser should notify C-Dax (ATV City) on receipt of goods regarding any claims for damages in transit.

5. RETURN OF GOODS

Goods will not be accepted for credit unless returned within 14 days of delivery. Freight on all goods returned to C-Dax (ATV City) will be paid for by the sender. Prior approval must be obtained. An invoice number must be provided with returned goods. A 10% restocking fee will be charged unless approved by an authorised C-Dax (ATV City) representative. The credit value of authorised returns will be the original value less freight, less restocking fee, unless the goods are defective, or an error was made on the part of C-Dax (ATV City).

CONTACT C-DAX (ATV CITY) FOR A FULL COPY OF OUR TERMS OF TRADE



IS DISTRIBUTED IN EUROPE EXCLUSIVELY BY



T: +44 (0)1953 609999 **F:** +44 (0)1953 609998 **E:** sales@atvcity.co.uk
W: www.c-dax.com **OR:** www.atvcity.co.uk

Distributed in Denmark, Sweden and Norway on behalf of ATV City by:



A: Rødkilde ATV, Rødkilde Gods, Rødkildevej 15, 5762 V. Skerninge, Denmark
T: +45 50 26 26 26 **W:** www.roedkilde.com **E:** atv@roedkilde.com

Other products available from ATV City/C-Dax dealers



A full range of products is available to view at www.atvcity.co.uk



CITY[®]

the best part of your atv



17: TERMS AND CONDITIONS, TYRE PATTERN GUIDE

TERMS AND CONDITIONS

in these Terms and Conditions:

Contract Shall mean the contract between the Company and the Customer.

Company Shall mean PPE ENTERPRISE LTD or Subsidiary or associated company thereof.

Customer Shall mean the person, firm or company identified in or by means of the Contract as ordering goods.

Goods Shall mean every, or where the context so requires, any item of whatsoever nature, which the Customer buys or has agreed to buy from the Company under this Contract.

1. Formation of Contract

a. All orders will be taken and all goods supplied by the Company subject to these terms and conditions and, subject to the 'Validity and Application' statement above, no other terms, conditions or warranties are to be implied into Contract unless expressly accepted in writing by an authorized representative of the Company.

b. Subject to the provision of clause 1. (a) Above mentioned, these terms and conditions are the only terms and conditions applicable to the Contract and shall supersede all earlier arrangements or agreements entered into or made between the Company and the Customer and shall apply to the exclusion of any other point in time.

2. Prices, Quotations and Estimates

a. The company shall only be bound by prices in writing and for a specified time. Any prices exhibited on the Company's premises constitute an Invitation to treat only.

b. Where the Company provides a quotation to a Customer, that quotation shall be available for acceptance by the Customer for a maximum period of fourteen days, otherwise expressly agreed in writing by an authorized representative of the Company. The Company may by written or oral notice withdrawn any quotation at any time prior to the Customer's acceptance.

c. If between the date of contract and the date of collection or delivery there are variations in the costs of transport, taxes, manufactures prices or other costs of charges, then the contract price may be varied at the discretion. That is to say that, unless the Company's quotation specifically provides for a fixed price contract, the prices ruling shall be those as the date of collection or delivery.

d. Where the Company provides the Customer with an estimate for the supply of goods, such estimate shall be provisional only and will be subject to variation in the price of such ordered items.

e. COMPANY PRICE LISTS ARE ALL EXCLUDED OF VAT.

3. Delivery and Carriage

a. Delivery commitments are entered into in good faith, but the Company shall not be liable for failure to deliver on any specified date nor shall such failure deemed to be a breach of contract or any part of these terms and conditions

b. All orders will be dispatched in accordance with the Company's current carriage policy. Where possible, the Company will endeavour to meet special delivery requirements subject to any and all additional costs of the same being borne by the Customer.

c. Where the contract requires delivery by instalments, each instalment shall be regarded as a separate contract and any defects in any instalment or failure to deliver any instalments shall not give the Customer the right to cancel the balance of deliveries due under this or any other contracts between the parties.

4. Failure to Take Delivery

If the customer fails to accept delivery of any goods ordered in accordance with the provisions of the Contract, the Company shall not be bound to tender or re-tender the goods, but the Company shall have the right:

a. To invoice such goods including the cost of non-acceptance for immediate payment.

b. To make a reasonable storage charge for the goods remaining on the Company's premises longer than one month.

c. To sell the goods elsewhere and recover any difference in the price including the costs of non-acceptance from the Customer.

5. Cancellation

The company shall be entitled to full indemnity if the customer cancels an order, which the Company has accepted. Orders accepted by the Company may not be cancelled by the Customer without the Company's prior written consent and in the event of such consent being given, the Company reserves the right to charge a cancellation fee as a condition thereof.

6. Stock Items

All goods which are stock items and which have been correctly supplied to the customer in accordance with the provisions of the Contract but which are then returned by the Customer for credit (where the Company has agreed to) will be subject to a minimum 25% restocking charge. All such returns must be made to the Company within 15 WORKING DAYS of delivery to the Customer and must be returned in an undamaged condition and fit for resale, including the packaging. The Company reserves the right to reject any returns considered unsuitable for resale for whatever reason.

7. Special Ordered Items

a. Orders for goods which are not general stock items and which are subject to special order provisions are only accepted by the Company on the basis that such orders cannot be cancelled by the Customer nor the goods returned to the Company and that a credit cannot be issued.

b. Notwithstanding the provisions of clause 7. as above, the Company may, exercising its sole discretion, allow the return for credit special order items. In this case such returns will be subject to a minimum 25% restocking charge.

8. Returned Goods

a. If the Customer wishes to return any Goods to the Company, a returns reference number must be first obtained from the Company and the items returned in accordance with the requirements of the Company. Any items returned to the Company without such a returns reference or otherwise contrary to the Company's requirements will be re-despatched to the Customer at the Customer's cost.

b. Return carriage charges cannot be accepted by the Company unless such charges have been expressly agreed by the Company prior to the return of the goods

c. NOTE ELECTRICAL GOODS I.E CDI'S AND REGULATURES ARE NOT RETURNABLE FOR CREDIT.

d. All damages and/or shortages must be reported in writing (including Fax or E-mails) within 5 days of parcel receipt in order to sustain a valid claim.

e. With respect to the provisions of this clause, the Company will take no action nor will it provide the Customer with a credit until the items are back with Company and have been subject to an examination. Such an examination will include inspection of the original packaging and Customer's invoice.



9. Passing of Risk

- a. Subject to the provisions of these conditions, all risks shall pass to the customer on delivery to or in accordance with the Customer's instruction or, in the case of carriage, to the carrier. It shall be responsibility of the Customer to arrange adequate insurance against all relative risks.
- b. The Customer shall have a reasonable time from delivery of the goods to effect inspection and examination after which time the goods shall be deemed to be satisfactory and shall be deemed accepted by the Customer.

10. Changes Required by the Customer

Any and all loss or expense occasioned to the Company as a result of changes required by the Customer to any order accepted by the Company shall be full reimbursed by the Customer to the Company.

11. Delays and Force Majeure

- a. In the case for ordered goods the Company will use its best endeavours to ensure availability of the same by the date and time requested. The Company can offer no guarantee with respect to the provision of this clause and cannot accept responsibility from the none or late availability of any goods or other reason beyond its control.
- b. In the event of the performance of any obligation accepted by the Company being prevented, delayed or in anyway interfered with by any direction of government or other competent authority, industrial dispute, strike, break down in plant machinery, fire, accident or by any other cause beyond the Company's reasonable control the Company may, at its sole option, suspend performance or cancel its obligation under the contract without damage or consequential loss arising.

12. Packaging

The Customer agrees that it shall not change, remove or in any way interfere with the packaging, trade marks or other marks and labels supplied with or relating to the goods.

13. Warranty

Any goods supplied to the Company will be entitled to the benefit of any warranty given by the manufactures of any such items. This will not affect the Customer's or, as the case may be, any sub-purchases statutory rights.

ELECTRICAL GOODS I.E CDI'S AND REGULATURES ARE NOT COVERED BY WARRANTY

14. Defective Goods

Subject to clause 13., above mentioned, and always subject to the provisions of any such warranty provided by the manufacturer, if it is proved to the Company's satisfaction that any goods as supplied, are defective, the Company may be prepared to rectify or replace at its option such defective goods. In the event that such rectification or replacement is not practicable the Company may give credit to an amount not exceeding the invoice price. In no circumstances whatsoever will the Company be liable for any further or consequential loss.

15. Passing of Title in Goods (Inc All Monies Clause)

- a. Unless otherwise stated in writing , any and or all goods supplied by the Company to the Customer shall remain the property of the Company until all monies due in respect of any goods supplied to the Customer at any time have been paid in full. Until such time as the Company has received such payment, legal and beneficial ownership in any such goods shall remain with the Company, and shall not pass to the Customer or to any sub-purchaser. Further, the Customer shall hold such goods as bailiff, store them in such a way that they can be identified as the property of the Company and keep them separate from the Customer's own property and the property of any other person or business
- b. The Customer's right to possession of the goods shall, for the purpose of the instant clause 15., cease if:
 - i. Upon presentation to a bank of any cheque tendered in respect of payment for goods it is returned dishonoured; or
 - ii. The Customer has not paid for the goods in full by the expiry of any credit period allowed by the Company; or
 - iii. The Customer is declared bankrupt or makes any proposal to his creditors for a composition or other voluntary arrangement; or
 - iv. A receiver, liquidator or administrator is appointed in respect of the Customer's business; or
 - v. An Encumbrance takes possession of any of the property or assets of the Customer; or
 - vi. The Customer cease, or threatens to cease, to carry on business; or
 - vii. The Customer reasonably apprehends that any of the events mentioned above is about to occur in relation to the Customer and notifies the Customer accordingly.
- c. On concession of the Customer's right to possession of the goods pursuant to the sub-clause immediately aforementioned, the Customer shall at his own expense make the goods available to the Company and allow the Company to repossess them. Further, the Customer hereby grants the Company its agent and employees an irrevocable licence (such licence to subsist notwithstanding termination of contract for any reason) to enter any premises where the goods are stored in order to repossess them or inspect at anytime.
- d. Although all goods remain the property of the Company until paid for, they shall be at the Customer's risk from time of delivery or collection and the Customer shall hold proceeds of any insurance against loss or damage on behalf of the Company as trustee for the Company.

16. Variations

The Company's policy is one of continuous development and improvement. Accordingly descriptions, specifications, prices, dimensions and weights etc. given in price lists, sales brochures etc. may change without notice; under such circumstances the Customer shall accept the goods so changed in fulfillment of the contract. No such variation shall, under any circumstances vitiate the contract.

17. Indemnity against Infringement of Industrial Property Rights

The Customer will fully indemnify and hold the Company harmless against any claim or liability in respect of any infringement of any Patent, Trademark, Registered Design or any other like claim resulting from compliance with the Customer's instructions express or implied.

18. Waiver

The omission to exercise, or any delay in exercising, any of its rights or remedies under these terms and conditions of business shall not constitute a waiver of any such rights or remedies by the Company.

ADVERTISE YOUR BUSINESS ON THE ATV CITY WEBSITE...

Advertise in on the ATV City website from £60.00 + VAT per year, and get your own personalised advert listing, displayed in our geographical dealer listings section, as per the examples below.

Simply supply us with your logo, company details, and any relevant imagery, and we will create your advert. All adverts will displayed for one year, and there's limited space available, so first come, first served!

For more information, please call 01953 609999 or email sales@atvcity.co.uk

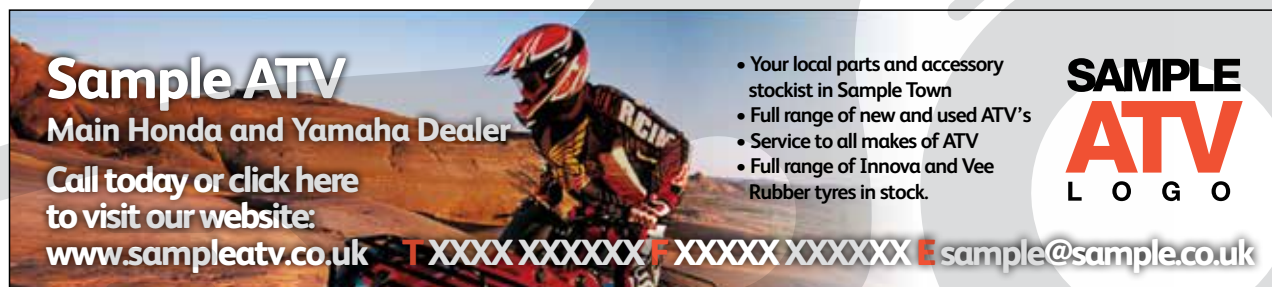

Sample ATV
Main Honda and Yamaha Dealer
Call today or click here to visit our website:
www.sampleatv.co.uk

- Your local parts and accessory stockist in Sample Town
- Full range of new and used ATV's
- Service to all makes of ATV
- Full range of Innova and Vee Rubber tyres in stock.

SAMPLE ATV LOGO

T XXXX XXXXXX F XXXXX XXXXXX E sample@sample.co.uk

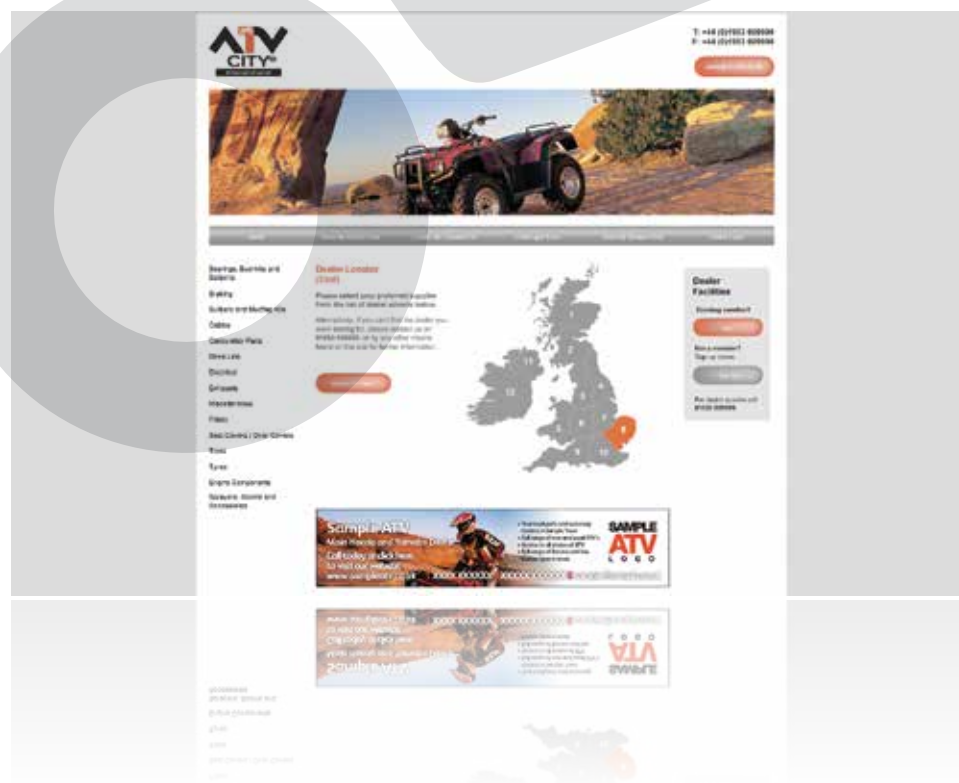

The screenshot shows the ATV City website interface. At the top, there's a navigation bar with the ATV City logo and a 'Find Us' button. Below this is a large banner image of an ATV. The main content area is divided into several sections: a list of dealer locations (Berkshire, Bucks and Bedfordshire, Cambridgeshire, etc.), a map of the UK with a red dot indicating the location of Sample ATV in London, and a detailed dealer listing for Sample ATV. The listing includes the company name, contact information, and a small version of the advertisement shown in the previous block.

Your bespoke advert will appear in the dealer listings section of the ATV City website, as per the example displayed.

Please visit our website and click 'Find Us' to view examples of current adverts.



TYRE PATTERN GUIDE



Innova
IA-8003
Speed Gear



Innova
IA-8008
Hawk Gear



Innova
IA-8004
Mud Gear



Innova
IA-8009
Knobby Gear



Innova
IA-8004
Mud Gear
Sand Camo



Innova
IA-8022
Racer Tyres



Innova
IA-8007 B
Land Hawk



Innova
IA-8040
Xtreme Radial

TYRE PATTERN GUIDE



Innova
IA8030
Cayman Turf



Innova
IA8028
Cyman AT



ARTRAX
AT-1201
MX Trax



ARTRAX
AT-1202
MX Trax



ARTRAX
AT-1205
MX Trax Racing



ARTRAX
AT-1307
Mudtrax



ARTRAX
AT-1206
MX Trax Racing



ARTRAX
AT-1301
Mudtrax



Vee Rubber
VRM 326



Vee Rubber
VRM 189
Grizzly



ATV City
Eleven Mile Lane,
Wymondham,
Norfolk,
NR18 9LR

Tel: 01953 609999
Fax: 01953 609998
sales@atvcity.co.uk
www.atvcity.co.uk

© 2014 ATV City

2014-01-07

A division of PPE Enterprises Ltd

