

POWERCOOL[®]

Operation and Maintenance Manual

READ AND SAVE THESE INSTRUCTIONS



Installation Guide
Rev. B
05/05/2023



Original English Instructions

www.bigassfans.com/support

Improper installation, delivery, or maintenance, including, but not limited to, any of the following actions by the customer or agent of the customer will constitute a breach of and will void all warranties:

- Failure to follow the required installation procedures specified in this Installation Guide and in all other documentation supplied with the unit and related equipment including documentation provided by the manufacturers of the individual unit and control components;
- Failure to follow all relevant codes and ordinances, including, but not limited to, the National Electrical Code (United States), applicable national and local electrical codes, and state and local building codes;
- Failure to follow electrical engineering industry standards regarding the approved method of installing solid-state electrical equipment having the characteristics of the unit, the unit controls, and their related components, even if such standards are not specifically referenced in any instructions or literature supplied by Big Ass Fans or provided by manufacturers.

All trademarks used herein are the properties of their respective owners. No part of this document may be reproduced or translated into a different language without the prior written consent of Big Ass Fans. The information contained in this document is subject to change without notice. For the most up-to-date information, see the online printable installation guide at www.bigassfans.com

Patent: www.bigassfans.com/patents • www.bigassfans.com/product-warranties

OPERATIONAL WARNINGS

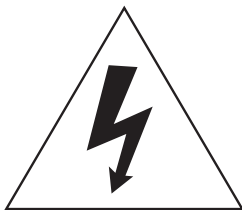

Electric Shock

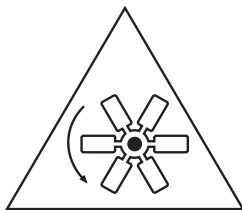

Moving Parts

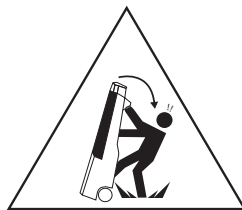

Tilt Hazard



IMPORTANT: Only use fresh water in the tank. Never use solvents or chemicals. This may cause a health hazard or damage the system.



If the unit is in an outdoor setting where wind speed is expected to exceed 20 mph (32 km/h), lay the unit flat on its back or fill the tank for increased stability and use the tie points to secure the unit.



If the unit has been subjected to an environment that has been flooded or submerged in more than 6 in. (152 mm) of water, a thorough inspection must be performed by an authorized service technician.

Use only as described in this manual. Do not carry out any maintenance other than that described in this manual or advised by Big Ass Fans Customer Service.

Not for use by children. Extreme caution is necessary when the unit is used near children and whenever it is left operating and unattended. Children should be supervised to ensure that they do not play with the unit or any remote applications.

Not for use by persons with reduced physical, sensory, or mental capabilities.

Do not run cord under carpeting. Do not cover cord with throw rugs, runners, or similar coverings. Do not route cord under furniture or appliances. Arrange cord away from traffic area and where it will not be tripped over.

The handle is designed to move the unit. Do not hang from the handle or use it in any way other than what it was designed for.

When tilting the unit back to move, always exercise extreme caution to ensure unit does not fall and cause serious injury.

To prevent a fire hazard, do not use with any opening or exhaust blocked, and keep unit free of anything that may reduce airflow. Do not put objects into the inlet grill or the outlet opening. This may cause electric shock, fire, or damage to the system.

Always plug directly into a wall socket. GFI outlet is recommended.

Do not handle any part of the plug or unit with wet hands.

Do not operate unit with a damaged cord or plug. Discard unit or return it to an authorized service facility for examination and/or repair.

Do not use in areas where gasoline/petrol, paint, or flammable liquids are used or stored or where their vapors are present. Do not use in conjunction with or directly next to an air freshener or similar products.

Always plug directly into a wall socket. Do not use an extension cord.

OPERATIONAL WARNINGS

If the unit is not working properly, has received a hard impact, or has been dropped or damaged, do not use and contact Big Ass Fans Customer Service.

Contact Big Ass Fans Customer Service when service or repair is required. Do not disassemble the unit unless properly trained. Incorrect reassembly may result in electric shock or fire.

Do not unplug by pulling on the cord. To unplug, grasp the plug, not the cord.

Do not stretch the cord or place it under strain. Keep cord away from heated surfaces.

Do not store near heat sources.

Do not use near furnaces, fireplaces, stoves, grills, or other high-temperature heat sources.

Do not use near open flames.

Turn off all controls before unplugging.

Unplug when not in use for extended periods of time and before filling, cleaning, maintenance, or servicing.

When refilling, only do so as described in this manual. Do not use hot water.

Always place unit on a firm, flat, level surface.

Do not tilt, move, or attempt to empty unit while it is operating.

Do not use unless the unit has been cleaned according to these instructions.

Use only cleaning agents recommended by Big Ass Fans.

Do not pour water into any openings other than the water tank.

The unit must be plugged into a power source that corresponds to the marking on the serial plate.

To avoid eye damage, do not stare directly at the unit's information display bar for extended periods of time.

The unit's installed safety guards may not block all objects from coming into contact with the fan blades.

Do not allow any object or material into the intake or outlet of the fan or to come into contact with the fan blade.

Never operate the unit without the safety guards in place.

Always inspect the safety guards to ensure they are not cracked or broken before operating the unit.

The Big Ass Fans product warranty will not cover equipment damage or failure that is caused by improper installation or use.

SETUP

Input Power	Power	Weight	Water Capacity
120 VAC, 60 Hz	100–1,000 W	136 lb (61.7 kg)	15 gal (57 L)

1. Unplug unit and fill tank



Only use fresh water in the tank. Never add chemicals or solutions to the tank during operation. Always unplug unit before refilling.

Unplug unit (if plugged in). Unscrew tank fill cap on back of unit. Fill tank using hose or other clean water source. When tank is full, replace cap and turn clockwise until it clicks once.

2. Plug in unit

Plug power cord into outlet. A beep indicates unit is ready to turn on.

3. Turn on unit





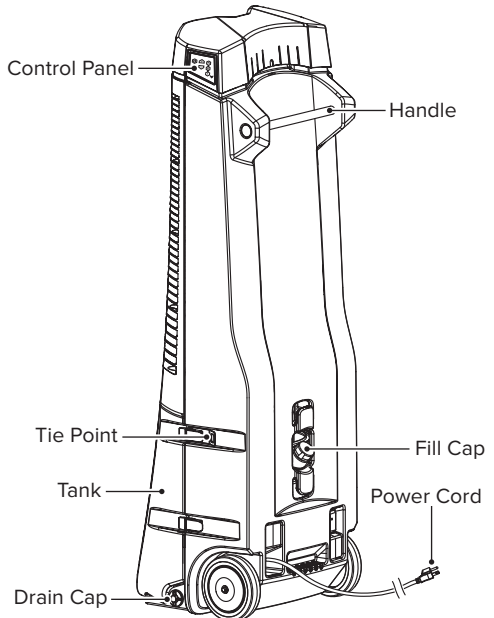
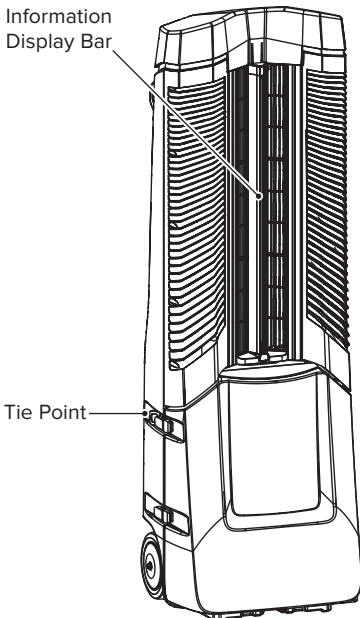

Press power button on control panel located on upper right side of unit. See the following page for control panel operation instructions.

PARTS DIAGRAM

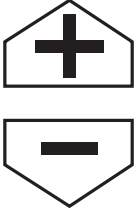
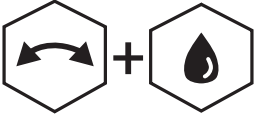

OPERATION

When the unit is powered on and the control panel is not being used, the information display bar on the front of the unit displays a random sequence of colors.

Control Panel Button	Function
	<p>Power Press to turn unit on/off.</p>
	<p>Oscillation Control (Yellow, White) Press once to activate oscillation, and then use the + and - buttons to increase or decrease oscillation speed (1–10). The oscillation speed is indicated by yellow lights on the information display bar. Press twice to center the airflow. A white light in the center of the information display bar indicates airflow is centered.</p>
	<p>Fan Control (Green) Press once to activate the fan, and then use the + and - buttons to increase or decrease fan speed (1–10). The fan speed is indicated by green lights on the information display bar. Press twice to set the fan speed to level 10 (maximum).</p>
	<p>Misting Control (Dark Blue)/Water Level (Light Blue) Press once to activate misting, and then use the + and - buttons to increase or decrease the misting level (1–10). The misting level is indicated by dark blue lights on the information display bar. <i>Note: It may take up to 60 seconds for misting to start after the Misting Control button is pressed.</i> Press twice to display the tank's water level on the information display bar. The water level is indicated by light blue lights.</p>
	<p>Function Adjustment/Display Bar Brightness Press to adjust the selected function (oscillation speed, fan speed, or misting level). To adjust the information display bar brightness or turn the display bar off, press and hold + and - until you hear a beep, and then use + and - to increase or decrease brightness.</p>
	<p>Lock/Unlock Control Panel Press and hold the Oscillation Control and Misting Control buttons for 10–12 seconds to lock the control panel. The green LED indicators next to the buttons will flash to indicate the control panel is locked. Press and hold the buttons for 10–12 seconds again to unlock the control panel.</p>
	<p>Tank Alert Indicator When the red LED indicator is lit, drain and clean the tank.</p>

MAINTENANCE SCHEDULE

⚠ WARNING: ELECTRICAL SHOCK HAZARD. Turn off unit and disconnect the power supply before performing service or maintenance. Failure to do so may result in serious injury or death.

		Daily	Weekly	Monthly
Housing	Wipe down with damp cloth as needed.	X		
	Hose down to remove dirt or dust buildup.		X	
	Clean with a mild soap.			X
	Decalcify outside surfaces with a household cleaner such as CLR® (as needed).		X	X
Power Cord	Check cord for tears or exposed wires. Do not use unit if cord damage is noted.	X		
	Check to make sure cord does not pose a trip hazard.	X		
Tank	Drain all water from tank and refill (after two days of non-use).	X		
	Clean tank when the red Tank Alert LED indicator on control panel is lit.		X	X (or as needed)
Storage	Drain all water from tank.	X	X	X
	Wrap power cord.	X	X	X
	Remove tank fill and drain caps for airflow. Store caps in a safe location.		X	X

CONTACT US

Customer Service

2348 Innovation Drive
Lexington, KY 40511
USA
877-244-3267
bigassfans.com

Accessories and Replacement Parts

www.bigassfans.com



www.bigassfans.com/support



BIG ASS FANS[®]

bigassfans.com



PWC-INST-420-MUL-01
REV. B 05/05/2023