

DISCHARGE VIEW

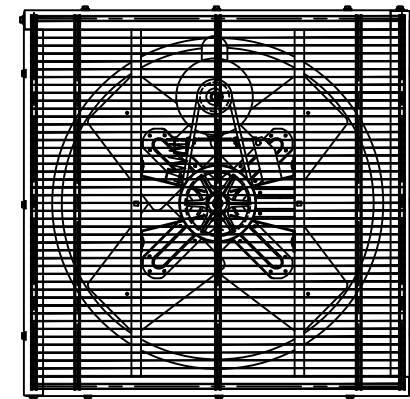
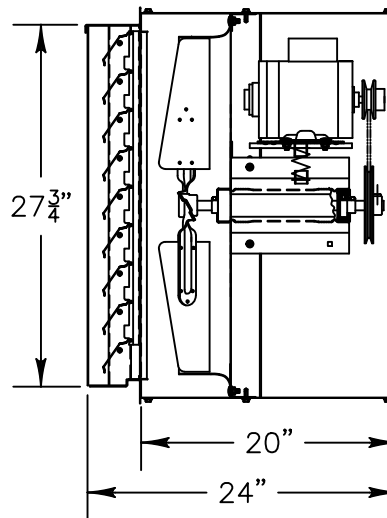

INTAKE VIEW

Fan Specifications

Blade Diameter:	24"	Motor Enclosure:	ODP
Drive:	Belt	Duty Cycle:	Continuous Duty
Horsepower:	1/3	Guard:	OSHA Compliant
Voltage:	115	Power Cord:	10' with molded plug
Phase:	1		
RPM:	705		

*See TriangleFans.com for performance specifications

*Specifications are subject to change without notice



VIK2412-V
WALL FAN

NOT TO SCALE | 14 OCT 2015