

FLCH4R Garage and Utility Electric Heater



Installation, Operation & Maintenance Instructions

Model No.	Volts	Amps		Watts		BTU/HR		Phase	Min Fuse Size*
		High	Low	High	Low	High	Low		
FLCH4R	208	17.3	8.66	3600	1800	12284	6142	1	25
	240	20	10	4800	2400	16378	8189	1	25

IMPORTANT INSTRUCTIONS

⚡ WARNING ⚠

WHEN USING ELECTRIC APPLIANCES, BASIC PRECAUTIONS SHOULD ALWAYS BE FOLLOWED TO REDUCE THE RISK OF FIRE, ELECTRIC SHOCK, AND INJURY TO PERSONS, INCLUDING THE FOLLOWING:

1. Read all instructions before installing or using this heater.
2. This heater is hot when in use. To avoid burns, do not let bare skin touch hot surfaces. Keep combustible materials, such as furniture, pillows, bedding papers, clothes, etc. and curtains at least 3 feet (0.9 m) from the front of the heater.
3. Extreme caution is necessary when any heater is used by or near children or invalids and whenever the heater is left operating and unattended.
4. Do not operate any heater after it malfunctions. Disconnect power at service panel and have heater inspected by a reputable electrician before using.
5. Do not use outdoors.
6. To disconnect heater, turn controls to off, and turn power to heater circuit at main disconnect panel.
7. Do not insert or allow foreign objects to enter any ventilation or exhaust opening as this may cause an electric shock, fire or damage to the heater.
8. To prevent a possible fire, do not block air intake or exhaust in any manner.
9. A heater has hot and arcing or sparking parts inside. Do not use it in areas where gasoline, paint, or flammable liquids are used or stored.

10. Use this heater only as described in this manual. Any other use not recommended by the manufacturer may cause fire, electric shock, or injury to persons.
11. This heater is provided with automatic resetting thermal limit and an alarm beeper to alert user if heater has overheated. If the alarm has activated, immediately turn off the heater and inspect and remove any objects around heater that may have blocked the airflow or otherwise caused the heater to overheat. Do not continue to use heater if it repeatedly overheats and activates the alarm.
CAUTION - On FFCH.R models, once heater has cycled off on the thermal limit, the heater will not return to operation until the user restarts and reprograms the control. Therefore, this unit is not recommended for freeze protection applications.
12. This heater is intended for comfort heating applications and not intended for use in special environments. Do not use damp or wet locations such as marine or greenhouse or in areas where corrosive or chemical agents are present.
13. When installing, see INSTALLATIONS INSTRUCTIONS for additional warnings and precautions.
14. For safe and efficient operation, and to extend the life of your heater, keep your heater clean - See MAINTENANCE INSTRUCTIONS.
15. This heater is not to be used as a portable unit and or have a cord and plug installed. (HARD WIRED ONLY)

SAVE THESE INSTRUCTIONS

INSTALLATION INSTRUCTIONS



WARNING



To prevent a possible fire, injury to persons or damage to the heater, adhere to the following:

1. Disconnect all power coming to heater at main service panel before wiring or servicing.
2. All wiring procedures and connections must be in accordance with the National and Local Codes having jurisdiction and the heater must be grounded.
3. Verify the power supply voltage coming to heater matches the ratings as shown on the heater nameplate.

CAUTION: ENERGIZING HEATER AT A VOLTAGE GREATER THAN THE VOLTAGE PRINTED ON THE NAMEPLATE WILL DAMAGE THE HEATER AND VOID THE WARRANTY AND COULD CAUSE A FIRE.

4. CAUTION: High temperature, risk of fire, keep electrical cords, drapery, furnishings, and other combustibles at least 3 feet (0.9 m) from front of heater. Do not install heater behind doors, below towel racks, or in an area where it is subject to being blocked by furniture, curtains or storage materials. Hot air from the heater may damage certain fabrics and plastics.
5. To reduce the risk of fire do not store or use gasoline or other flammable vapors and liquids in the vicinity of the heater.
6. When heater is to be wall or ceiling mounted, the anchoring provision must be sufficient strength to support the total weight of the heater plus the weight of the mounting provisions. Failure to properly secure the supporting members of the building structure could allow the heater to fall.
7. The following minimum clearances must be maintained:
 - 30° Tilted, Bottom of Heater to Floor: 6' (1.8 M) minimum, 11' (3.3 M) recommended maximum
 - Horizontal Airflow, Bottom of Heater to Floor: 6' (1.8 M) minimum, 8' (2.4 M) recommended maximum
 - Side of heater to adjacent wall: 6" (13 mm)
8. Do not use this heater for dry out as paint, plaster, sawdust and drywall sanding dust will permanently damage the heater and must be kept out of the heater.

Hardware included:

Figure 1

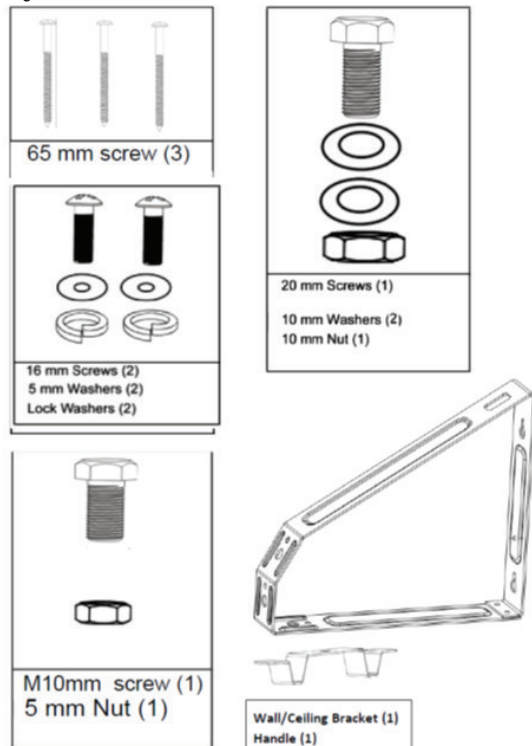

Unpacking Your New Heater

Remove heater from box, locate parts bag in packing material, and inspect to make sure heater is not damaged or missing parts. If damaged or parts are missing, call our Technical Service Hotline at 1-800-642-4328 for assistance. Do not return to store where purchased until you first call the above number for assistance.

Tools Needed

You will need the following tools to install your electric heater:

- Phillips head Screwdriver • 5/32 in. or 4 mm drill bit
- Power Drill • Stud finder
- For FLCH-R models, the remote controls are powered by 2 AAA batteries. Batteries are not included with the heater.

Hardware Required for Wiring Heater:

You will also need the following hardware for installation:

- Enough # 10 AWG copper wire (2 power conductors plus ground) suitable for application to route from electrical panel to heater.
- Suitable Junction Box and connectors as required for application.
- Appropriate size wire nuts for connection branch circuit wires to heater pigtails.
- A length of flexible conduit (or as required by the NEC and local codes) to route power to heater.

NOTE: Hardware supplied is intended for installation into wood framing only. If installation into other type of construction, additional hardware will be required for correct installation.

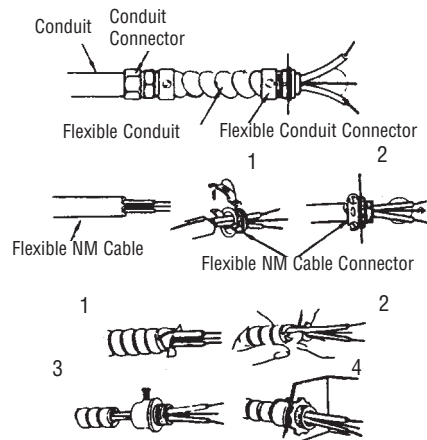

Figure 2 - Connectors, cable, and hardware used to wire the FLCH Models.

Locating the Heater

The heater should be installed out of traffic areas and at least 6' off the floor. The direction of air flow should not be restricted (ie: by columns or machinery) and the air flow should wipe exposed walls, rather than blowing directly at them. When more than one heater is used in an area, the heaters should be arranged so that the air discharge of each heater supports the air flow of the others to provide best circulation of warm air, as indicated in Figure 3, below.

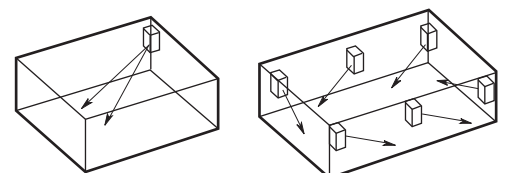
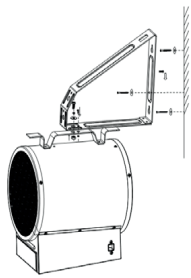

Figure 3

INSTALLATION INSTRUCTIONS

Figure 4 Wall Mounting



FOR WALL MOUNT APPLICATIONS

Figure 5 Ceiling Mounting

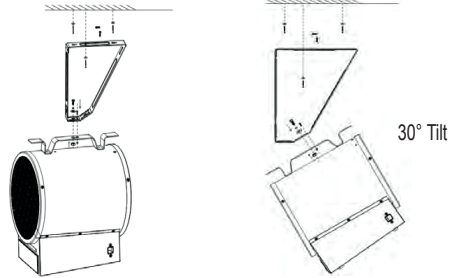

FOR CEILING MOUNT APPLICATIONS

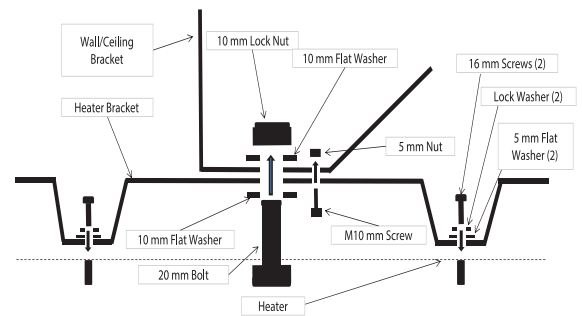

DETAILED BRACKET ASSEMBLY ILLUSTRATION

Figure 6 Minimum Clearances

Wall Mounting:

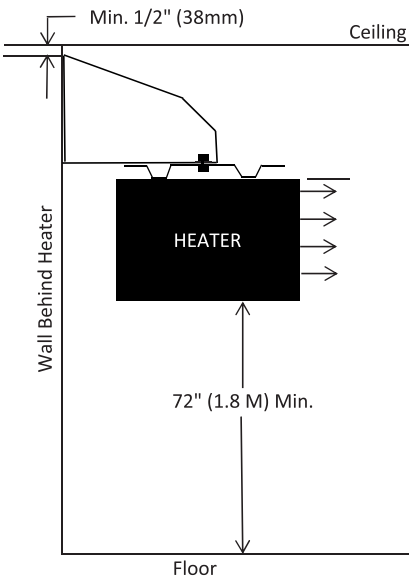

Ceiling Mounting:

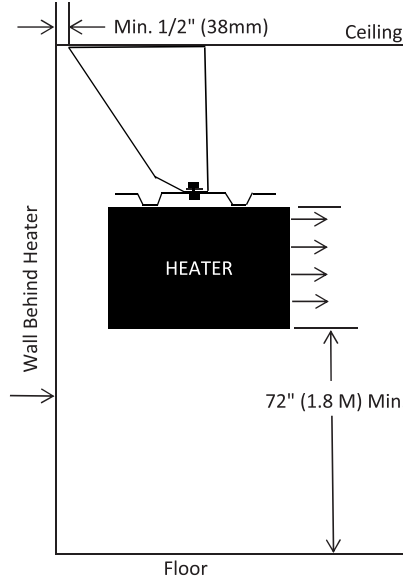

Ceiling Mounted With Heater Tilted to 30°

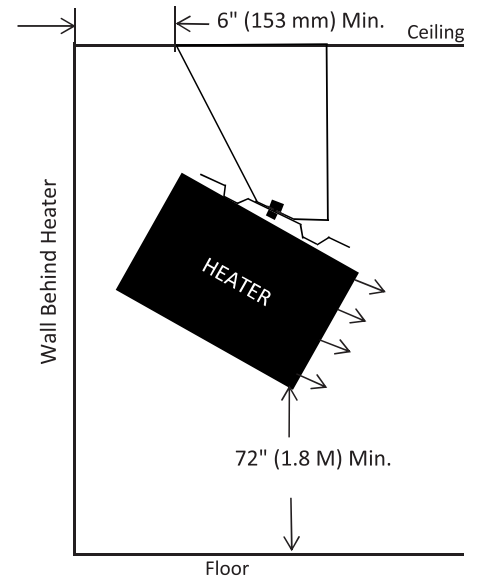

WARNING:

Fall Hazard - Heater must be attached to a joist with 3 screws (two at keyhole slots and third safety screw at center hole) to prevent heater from possibly falling. The screws provided with heater are intended for installing in wood framing only and not intended for metal joists or other types of construction. If installation into other type of construction, additional hardware will be required for correct installation. All hardware must be tightened securely.

HEATER MOUNTING

Attaching the wall/ceiling mounting bracket:

1. Locate the wood stud or joist in ceiling and mark line in location for heater to be installed.
NOTE: The wall/ceiling mounting bracket allows installation onto a wall or ceiling using the specific mounting holes and minimum clearances as shown in Fig 4, 5, 6 and 7.
2. Determine the desired location for mounting making sure the minimum clearances as noted in this manual are maintained and using the bracket as a template, mark the two keyhole locations on the wall or ceiling for drilling.

Figure 7 Wall/Ceiling Bracket

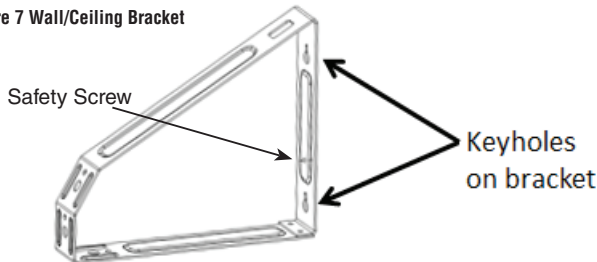

3. Use the 5/32 in. (4 mm) drill bit pre-drill two holes for screws at the locations marked in step 2.
4. Install two 2.5" (65 mm) screws into the holes leaving approximately 1/8" of the screw offset from the wall. Ensure that both screws are inserted at least 1.5" into the stud or joist.
5. Hook the mounting bracket onto the wall (or ceiling) by fitting the two keyholes on the bracket over the two screws and pushing the bracket



6. down into place. Mark the location of the center (3rd safety) hole onto the wall or ceiling.
6. Use the 5/32 in. (4 mm) drill bit to pre-drill a hole for the 3rd safety screw.
7. Attach the heater handle bracket to the heater using the two screws and washers preassembled to the top of the heater making sure the smaller hole in bracket faces the rear of heater. Remove the screws and then attach bracket making sure both screws are tight.
8. Attach the wall/ceiling bracket to the heater using the larger 20 mm (.8") bolt, two flat washers and lock nuts as shown in Fig. 5. To prevent rotation, a small M10 mm bolt and nut are provided in the parts bag. Assemble this smaller screw into the small hole through wall bracket and heater bracket as showing in Fig. 5. and securely tighten both bolts.
9. Attach the heater and mounting bracket assembly to the wall (or ceiling):

CAUTION - The keyhole slots are provided to assist in the installation by temporarily supporting the heater until the third safety screw is installed into the 3rd hole in bracket. Failure to install the 3rd or safety screw in the center hole location in the bracket could allow the heater to fall.

- a. Hook bracket onto the two screws (installed at Step 4) by fitting heater and wall/ceiling bracket on the two screws through the keyholes on the bracket and pushing the bracket into place.
- b. Insert the third 2.5" (65 mm) safety screw through the center hole on the bracket and into the pre-drilled hole (Step 6) in the wall or ceiling.
- c. Tighten all three screws to secure the mounting bracket and heater assembly to the wall.

WIRING - INSTRUCTIONS

After heater has been properly mounted to the building structure and appropriate branch circuit wiring has been routed to the heater location in accordance with the National Electrical Code and local codes, the heater is now ready for the heater to be connected to the branch circuit.

 **WARNING** 

Risk of Electric Shock or Fire
Make sure electric power is disconnected at main electrical panel before attempting to connect heater to branch circuit. Verify branch circuit voltage is same as noted on heater nameplate. Connecting heater to a voltage greater than the heater nameplate rating could damage the heater and cause a fire.

Heater is provided with a 7/8" (22mm) hole into wiring compartment for routing of branch circuit conductors. Appropriate conduit and fittings must be provided for correct and safe installation.

1. Remove the field wiring cover located on bottom of heater by removing two screws. See Figure 8 and Figure 9 for reference.
2. Bring branch circuit conductors to heater and into wiring compartment allowing approximately 6" (153mm) of wire inside heater compartment for wire connections. Install appropriate cable fitting into the heater as shown in Figure 10 and Figure 11.
3. Following the wiring diagrams in Figure 12 connect the supply wiring to the heater lead wires inside the wiring compartment.
 - Green pigtail – connect to earth ground
 - Black pigtails – connect to branch circuit power
4. Carefully fold all three wire connections back into heater wiring box making sure all connections are tight. See Figure 13-14 for reference.
5. Replace wiring box cover with two screws previously removed.

Figure 8: Wiring cover located at bottom of heater



Figure 9: Removing wiring cover exposes wires

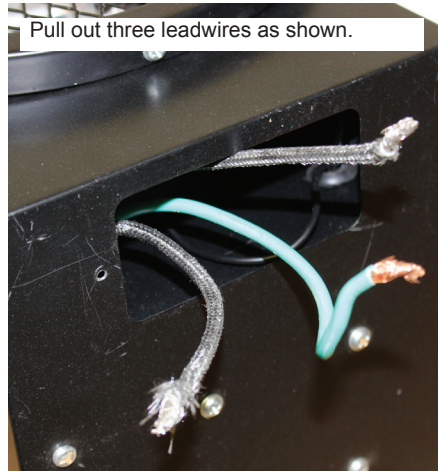

Figure 10: Setup conduit wires

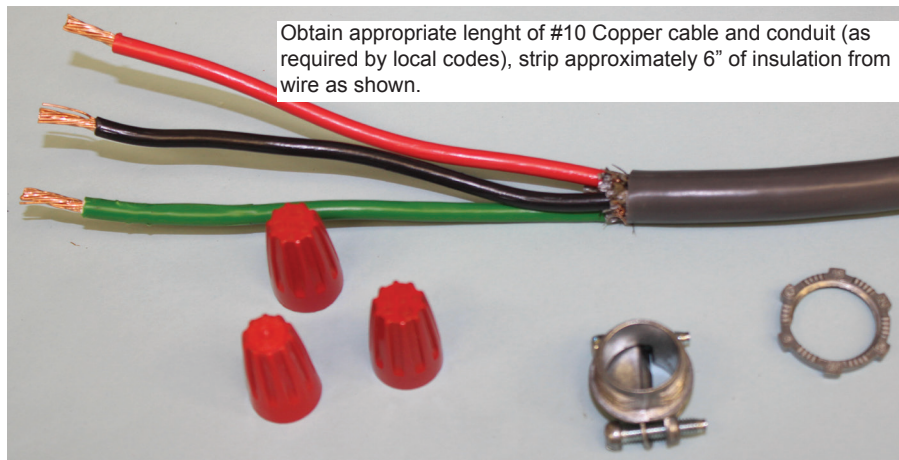
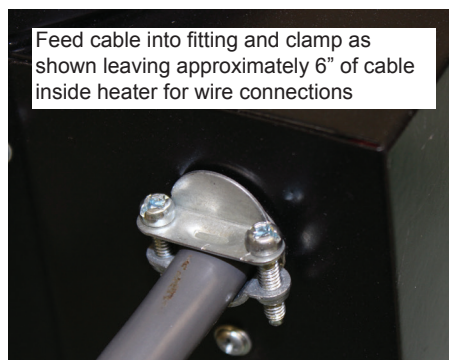

Figure 11: Installing cable fitting to heater



WIRING - INSTRUCTIONS

Figure 12: Wiring Diagram for FLCH4R

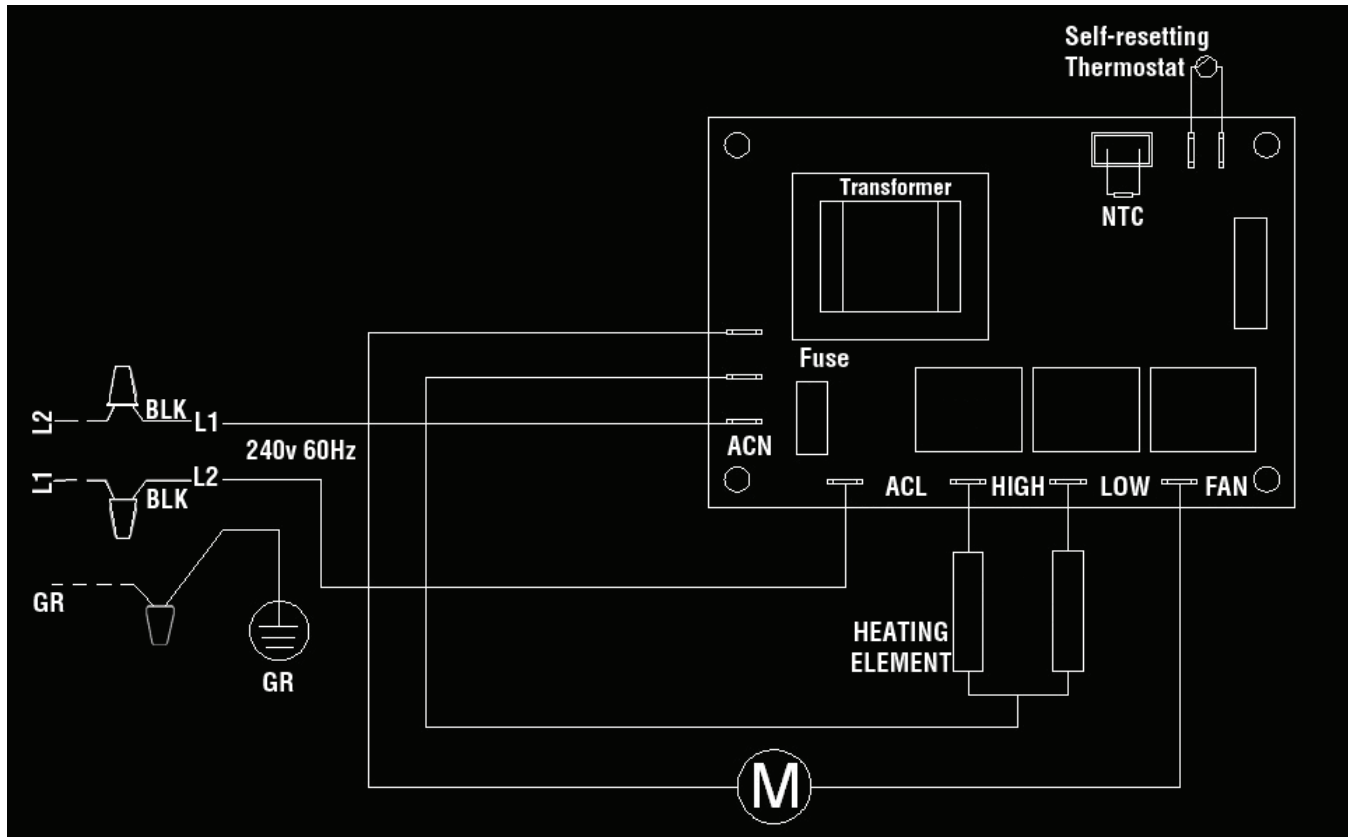
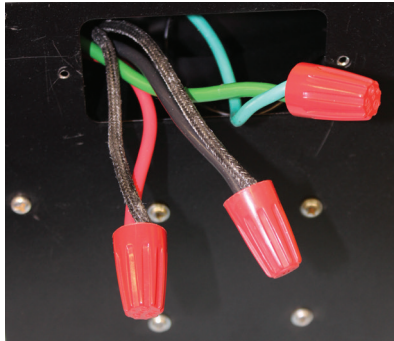

Figure 13: Field wiring connected to heater wires using wire nuts



Make the three connections as shown using wire nuts or approved connectors making sure all connections are tight.

Figure 14: Wire connections carefully pushed into wiring compartment.



Carefully push the wires and connections into wiring compartment as shown making sure connections remain tight and replace wiring cover with the two screws.

OPERATING - INSTRUCTIONS

Heater Control Panel:



1. Heater must be properly installed and correctly wired before operation.
2. Turn power supply to heater "ON" at main switch panel.
3. Once the heater has power, the red POWER light will be on.
4. Pushing the red POWER button will turn the heater ON and OFF. When this button is pressed, the heater and fan will immediately come on and the digital display will flash with the numbers "80" for approximately 5 seconds.
 - a. If the room temperature is lower than 65°F, the heater will continue to run until the room temperature reaches 65°F and the heater will then cycle on and off to maintain approximately this room temperature.
 - b. If the room temperature is higher than 65°F, the display window will show 65 and flash 5 times and the heater and fan will stop.
5. **Adjusting Power Level:** While the unit ON, push the green mode button once. This will activate the power selection mode and the red light over the "L" or "H" will be flashing to show the current setting. To change from High to Low or Low to High, use the UP or DOWN Arrow buttons. After approximately 5 seconds the control will then be programmed for the selected output. Note: To save energy, the heater will automatically adjust the power output to low power when room temperature is 2°F below the set point temperature.
6. **Adjusting temperature:** While the heater is ON, push the green mode button twice. This will activate the temperature selection mode and the digital display will flash with the current setting. To adjust, use the UP or DOWN button until the desired temperature shows on the display. After 5 seconds the display will change back to displaying the room temperature
7. **Setting Time On Feature:**

Note: If this feature is not selected, the heater will continue to operate to maintain the desired temperature. This feature allows the heater to operate for only a predetermined time. While the heater is ON, push the green mode button three times. This will activate the timer mode and the display will flash with "0H". By pressing the UP or DOWN Arrow buttons, the display will show the number of hours the timer will allow the heater to remain on (1H-9H where 1H = 1 hour, and 9H = 9 hours). After 5 seconds, the controller will lock in the setting.
8. Once the controller has been programmed, the heater will cycle on and off to maintain the desired room temperature. To help extend the life of the heater, after the heater has reached the desired temperature and the controller turns off the heating element, the fan will continue to operate for approximately 3 minutes to cool down the heater. This fan delay off feature also occurs when the heater POWER button is pushed to turn off the heater while it is heating. The fan will continue to run to cool down the heater.
9. To turn off the heater, push the red POWER button. If the heater is operating, the heater will turn off, but the fan will continue running for approximately 3 minutes to allow the heater to cool.

NOTE: The first time you operate the unit, it may smoke slightly. This is due to the residual cleaning agents used to clean the element when the heater is manufactured. This is normal and does not indicate a problem with the unit. This condition will stop after the heater has been in operation for a few minutes.

Automatic Thermal Limit: This heater is equipped with a thermal limit which will automatically shut off the heater in the event of overheating. Should the thermal limit activate an ALARM will be activated. The alarm will be a beeper that will sound. As the heater cools, the thermal limit will automatically reset the display will show "E3" indicating the heater is non-operational. Should the unit overheat and activate the thermal limit, the display will show "E3" and the red "POWER" light will flash. The cause of the overheating should be determined before further operation. To return heater to operating mode will require user to press power button on remote or heater. User must reset control to desired wattage output and room temperature. Do not continue to use heater if it repeatedly overheats to cycle the safety thermal limit as this could lead to permanent damage to heater or a fire.

Automatic Fan Delay: The FLCH4R is provided with an automatic fan off delay. As the room ambient reaches the preset temperature level of the heater control will de-energize the heating element within the heater while the fan continues to run for approximately 3 minutes to allow the heater to cool.

MAINTENANCE - INSTRUCTIONS

User Cleaning Instructions:

1. After the heater has cooled, a vacuum cleaner with brush attachment may be used to remove dust and lint from exterior surfaces of the heater including the grille opening. Compressed air may also be used to blow out dust from inside heater.
2. With a damp cloth, wipe dust and lint from grille and exterior surfaces. Be careful not to let the water enter the inside of appliance.
3. To protect the enclosure, don't splash water onto the heater, and never use solvents to clean the heater.
4. Return power to heater and check to make sure it is operating properly.

Maintenance Cleaning Instructions:

(To be performed only by Qualified Service Personnel)

At least annually, the heater should be cleaned and serviced by a qualified service person to assure safe and efficient operation. After completing the cleaning and servicing, the heater should be checked for proper operation.

The remote control is powered by 2 AAA batteries. These should be replaced periodically or at least annually.

TROUBLESHOOTING GUIDE

Problem	Cause	Solution
Fan stays on when heat shuts off.	1. Fan delay cycles On/Off until elements are cool	1. Heater is operating correctly for models.
Heating element does not glow red	1. Heating element is made of stainless steel and will not glow red to produce heat.	1. Heater is operating correctly.
Do not feel heat or air flow	1. No Power to heater 2. Desired room temperature reached. 3. Heater does not heat area in front of heater, it will disperse heat throughout room and heat entire space.	1. Check power connections / connect heater to power supply. 2. Thermostat will shut off once desired room temperature is reached. Heater is operating correctly. 3. Heater is operating correctly.

LIMITED WARRANTY

The products covered by this installation manual, manufactured and/or sold by Marley Engineered Products, are warranted against defects in workmanship and materials for one year from date of purchase. This warranty does not apply to damage from accident, misuse, or alteration; nor where the connected voltage is more than 5% above the nameplate voltage; nor to equipment improperly installed or wired or maintained in violation of the product's installation instructions. All claims for warranty work must be accompanied by proof of the date of purchase.

The customer shall be responsible for all costs incurred in the removal or reinstallation of products, including labor costs, and shipping costs incurred to return products to Marley Engineered Products Returned Goods Department. Within the limitations of this warranty, inoperative units should be returned to 470 Beauty Spot Road, Bennettsville, SC 29512, with a complete description of the problem, proof of purchase documents, and customer's full name and address. Merchandise returned to the factory must also be accompanied by a Material Return Authorization (MRA) a available from Marley Engineered Products. For warranty questions and assistance in obtaining the MRA documents required for return of the product, contact Marley Engineered Products in Bennettsville, SC, at 1-800-642-4328.

When requesting the MRA, include Model numbers and date code as shown on the product's nameplate. In warranty returns will be repaired or replaced, at our option, at no charge to you with return freight paid by Marley. It is agreed that such repair or replacement is the exclusive remedy available from Marley Engineered Products.

THE ABOVE WARRANTIES ARE IN LIEU OF ALL OTHER WARRANTIES EXPRESSED OR IMPLIED, AND ALL IMPLIED WARRANTIES OF MERCHANTABILITY AND FITNESS FOR A PARTICULAR PURPOSE WHICH EXCEED THE AFORESAID EXPRESSED WARRANTIES ARE HEREBY DISCLAIMED AND EXCLUDED FROM THIS AGREEMENT. MARLEY ENGINEERED PRODUCTS SHALL NOT BE LIABLE FOR CONSEQUENTIAL DAMAGES ARISING WITH RESPECT TO THE PRODUCT, WHETHER BASED UPON NEGLIGENCE, TORT, STRICT LIABILITY, OR CONTRACT.

Some states do not allow the exclusion or limitation of incidental or consequential damages, so the above exclusion or limitation may not apply to you. This warranty gives you specific legal rights, and you may also have other rights which vary from state to state.

HOW TO OBTAIN WARRANTY SERVICE AND WARRANTY PARTS PLUS GENERAL INFORMATION

- | | |
|--------------------------------|--|
| 1. Warranty Service or Parts | 1-800-642-4328 |
| 2. Purchase Replacement Parts | 1-800-654-3545 |
| 3. General Product Information | www.marleymep.com |

Note: When obtaining service always have the following:

1. Model number of the product
2. Date of manufacture
3. Part number or description



Marley[®]
Engineered Products

470 Beauty Spot Rd. East
Bennettsville, SC 29512 USA