

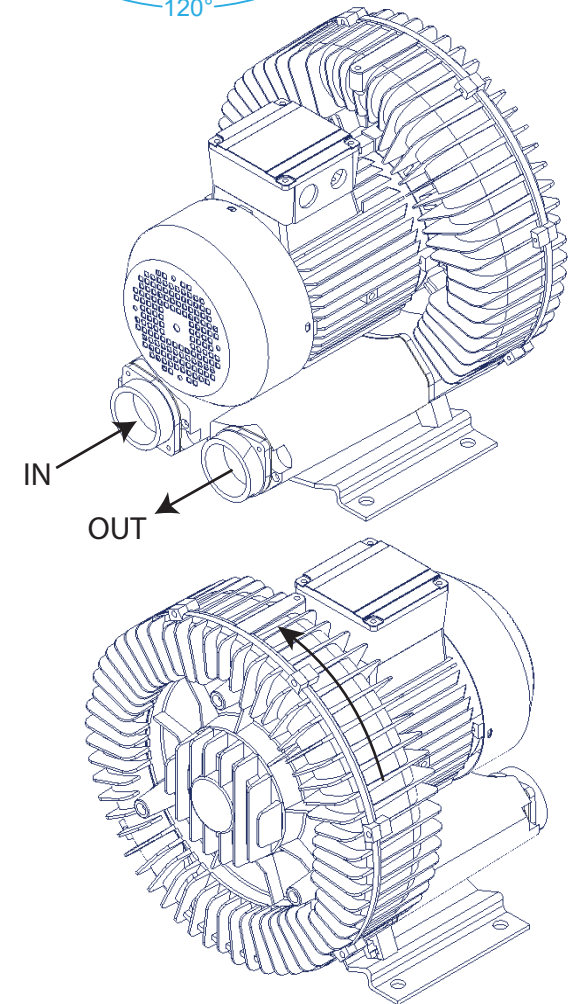

Phase	Model Number	Curve Number	Frequency (Hz)	KW	HP	Max Flow (SCFM)	Max Pressure ("H ₂ O)	Maximum Vacuum	Sound Level (db)	Inlet Diameter	Voltage	Current (A)	Weight (lbs)
3	AB-1100	A24	60Hz	11.00	15.00	791	68	72	81	4.00"	220-275/380-480	37.0Δ/21.4Y	220
			50Hz	9.30	12.50	659	47	50	77		200-240/345-415	36.0Δ/20.8Y	

**Sound db measured at 3ft.

MODEL NO. : AB-1100 SINGLE STAGE

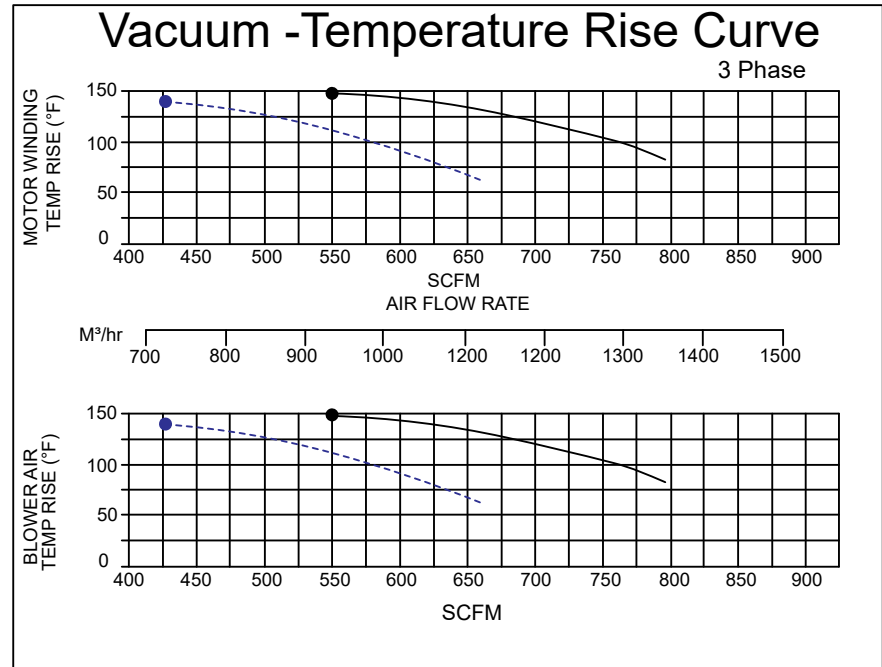
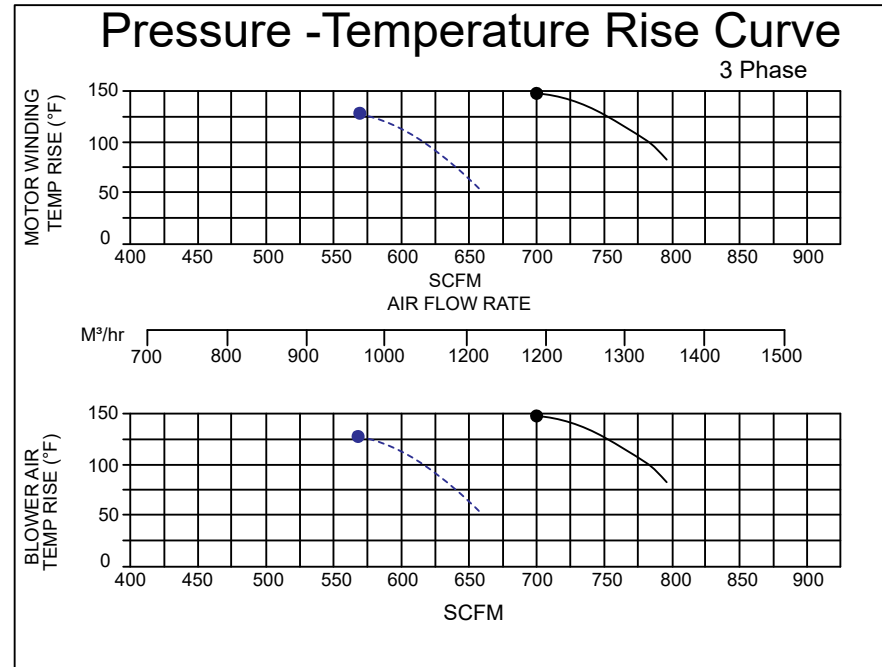
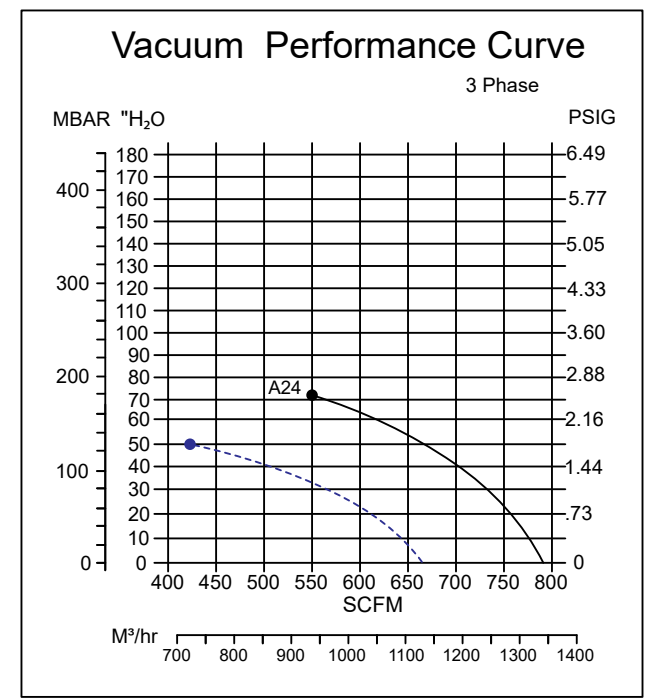
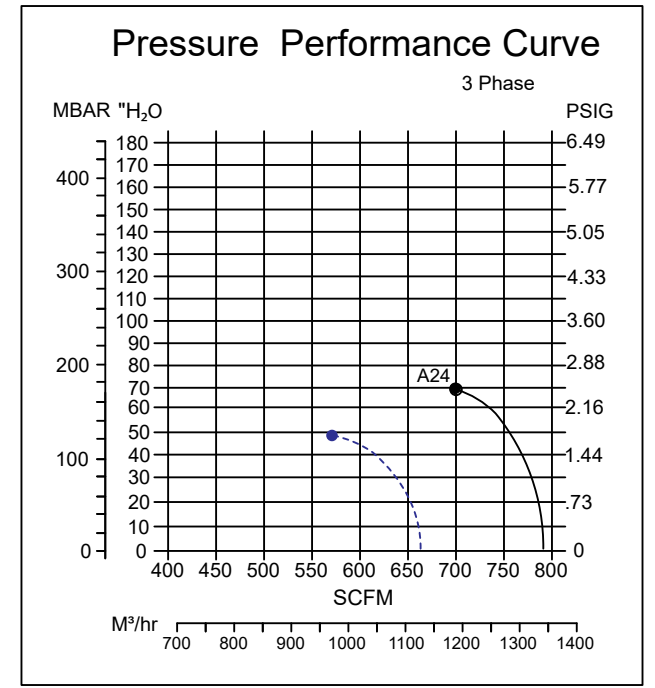
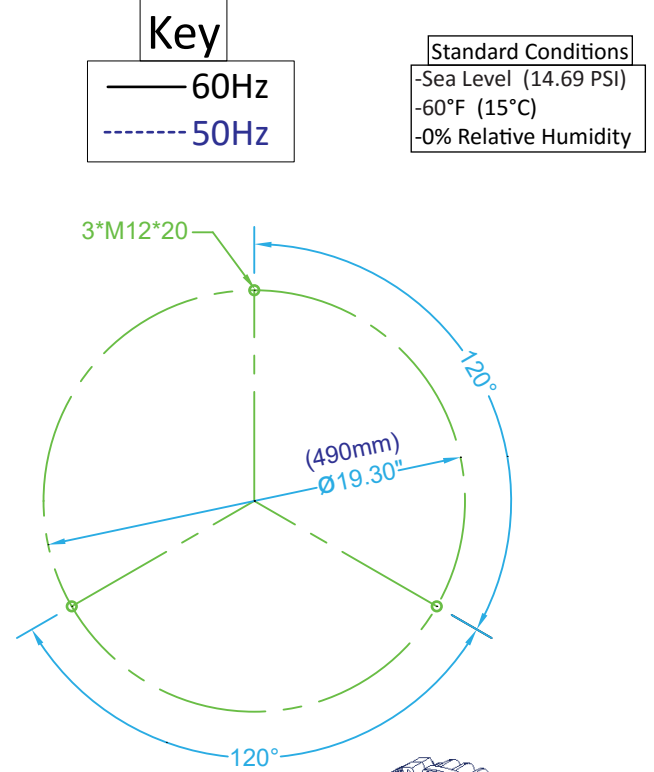
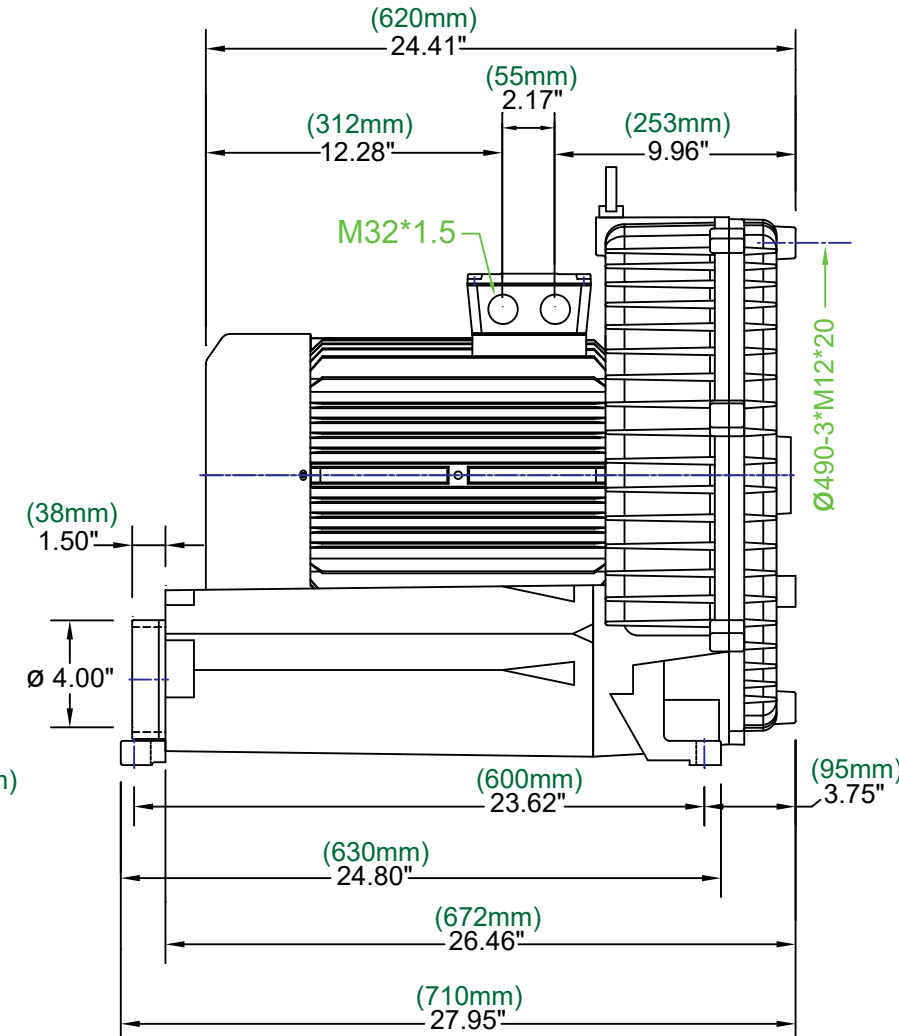
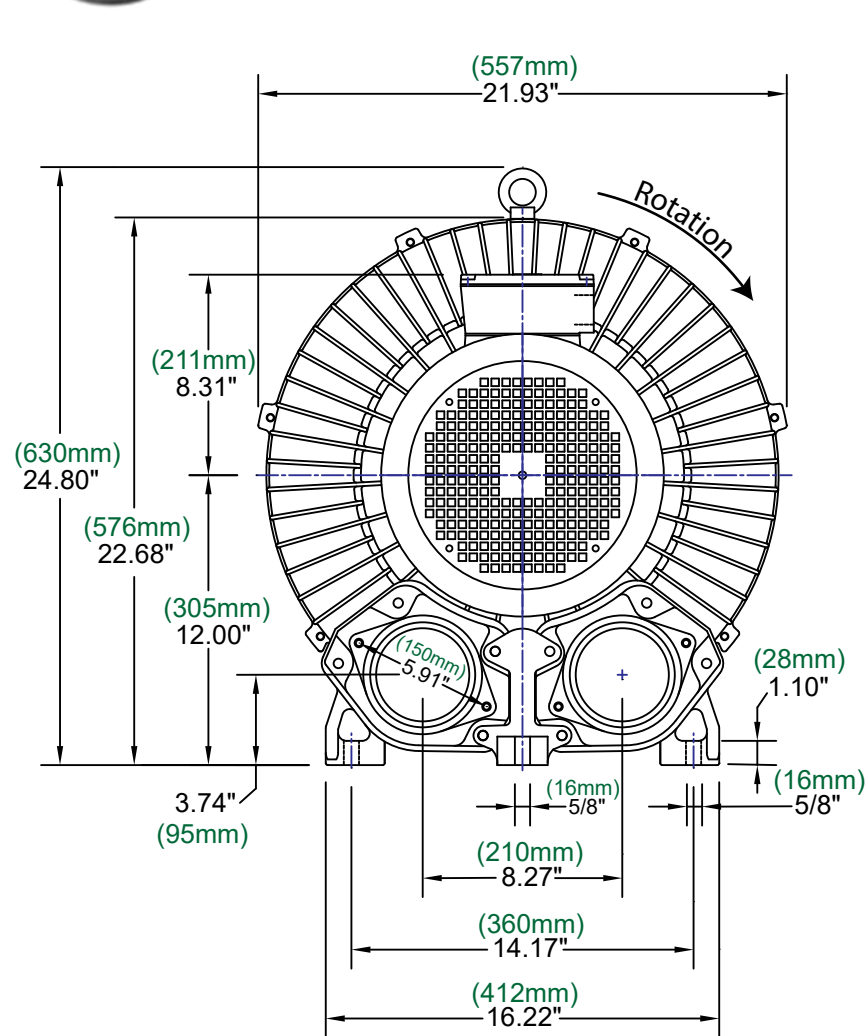

Disclaimer
Ownership of this document and all accompanying information and data including but not limited to all applicable copyrights, trade secrets, patents and other intellectual property remain the property of Atlantic Blowers and are not to be copied, duplicated or reproduced, nor transmitted or disclosed to a third party without express written permission from Atlantic Blowers. Atlantic Blowers makes no representation or warranties, express or implied, with respect to the reuse of the data provided herewith, regardless of its format or the means of its transmission. The user accepts the data "as is", and assumes all risks associated with its use.