

Model 5KK30
Air-Cooled Portable Air Conditioner
Submittal Data



SD-5KK30-4

STANDARD FEATURES

- 29,000 Btu Cooling Capacity
- Spot-Cool / Room-Cool Thermostat Settings
- Internally Insulated with Fiberglass Insulation
- Thermostatic Control with Multi-Speed Fan
- Double Shaft Motor for Two Fans
- R410A Refrigerant
- Optional Easy Install Condensate Pump Kit With Overflow Protection
- 230V/1 Phase
- Directional Nozzles (3)
- Heavy Duty Twin Wheel Casters for Portability
- Self-Diagnostic System
- Off-Time
- Washable Filters

SAFETY DEVICES

- Compressor Overload Protection
- Anti-freezing Thermistor
- Full Drain Tank Switch
- Automatic Restart (Power Interruption)
- Compressor Time Delay Program
- High Pressure Switch

OPTIONAL ACCESSORIES

- Condenser Discharge Kits
- Condenser Return Kits
- Condenser Return Air Adapters
- Condensate Pump Kits



SPECIFICATIONS

Model Number	5KK30
Cooling Capacity	29,000 BTU/hr
Cooling Test Conditions	95°F
Voltage/Phase/Hz	230/1/60
Amperage	16
Fuse Size	20 Amps*
LCDI Plug Configuration	NEMA 6-20P
Power Cord Length	10'
Refrigerant Type	R410A
Dimensions	47.3"H x 22"W x 29.4"D
Net Weight	216 Lbs
Shipping Weight	238 Lbs
Condensate Tank Capacity	3.17 Gal

*Time delay fuses and circuit breakers are recommended

ADDITIONAL SPECIFICATIONS

Ambient Temperature Range	64 - 113°F
Setting Temperature (Room Cool)	64 - 86°F
Setting Temperature (Spot Cool)	32 - 86°F
Application Area Ft ² (Room Cool Mode)	743
Refrigerant Type / Ounces	R410A / 44.5
Design Pressure High/Low	450 / 280 PSIG
Indoor Air Flow High/Low	741 / 635 CFM
Hot Air Duct Diameter	16"
Maximum Exhaust Duct Length	60'
Condenser Air Flow	1560 CFM
FLA	14.8 Amps
Max Duct Length: Cold Air Supply	45 ft
Max Duct Length: Hot Air Discharge	60 ft
Duct Connection Condenser Return Kit	12 in
Drain Type	Bucket (4 gal.)
Sound level (dBA)	63



260 North Elm St.
 Westfield, MA 0108
Phone: 413-564-5520
Fax: 413-564-5530
 www.Koldwave.com

Project: _____ Date: _____
 Location: _____
 Customer: _____
 Engineer: _____
 Submitted By: _____
 For: Reference Approval Construction
 Unit Designation: _____
 Schedule Number: _____

Model 5KK30-Submittal Data

CONTROL PANEL

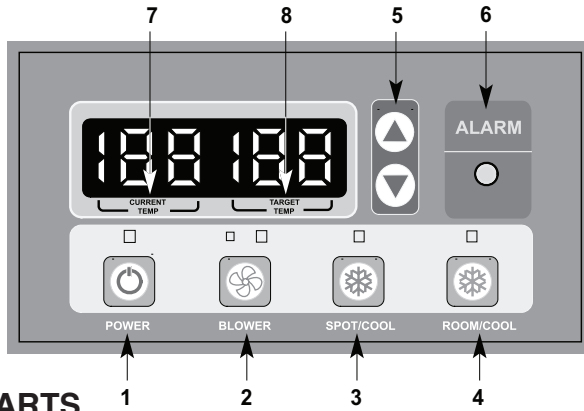

Control Panel Key Buttons:

1. Power
2. Blower
3. Spot/Cool
4. Room/Cool
5. Set Temperature
6. Alarm
7. Current Temperature
8. Target Temperature

COMPONENT PARTS

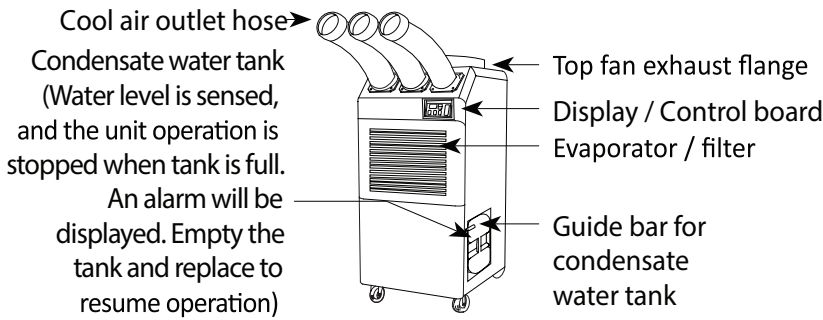

Front and Right Side View

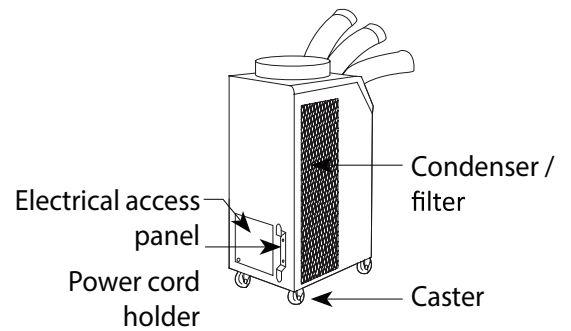

Back and Left Side View

DIMENSIONS (In Inches)

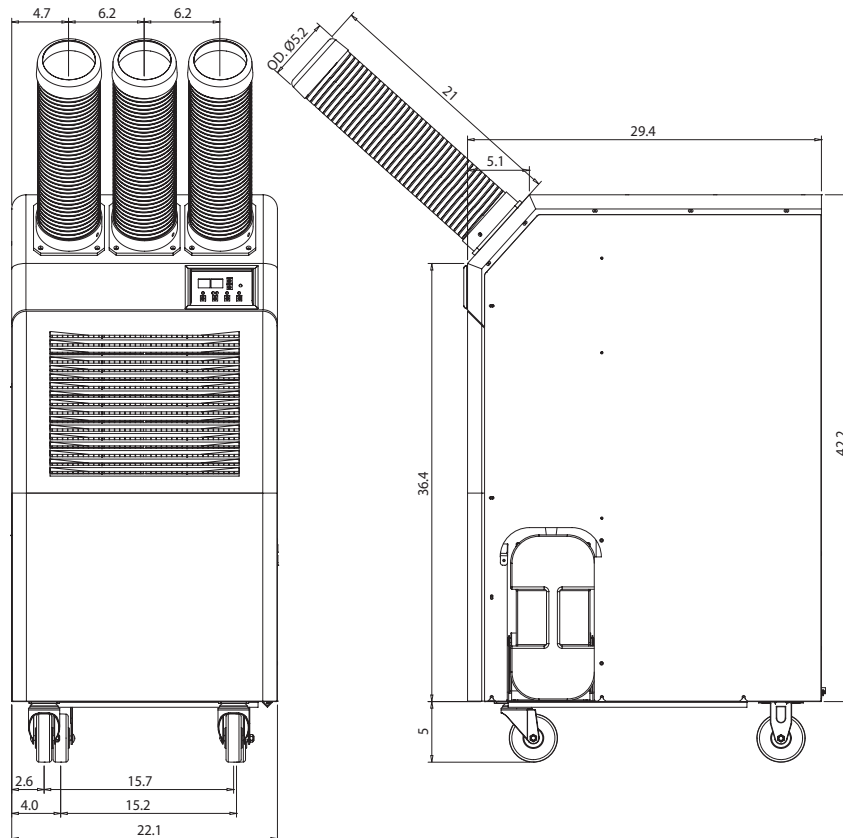

ASSEMBLY

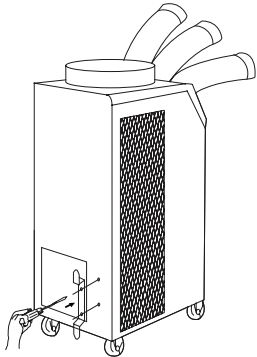

Figure 1

Power Cord Holder

1. Take out the cord holder from the accessory box.
2. Place the cord holder on the back side of air conditioner.
3. Use screws (enclosed inside of accessory box with cord holder) to install the cord holder on the air conditioner as shown in Figure 1.

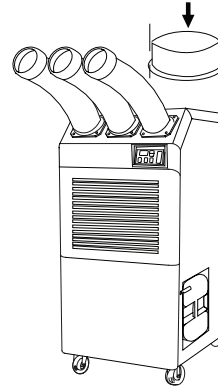

Figure 2

Top Fan Exhaust Flange

1. Remove the top fan exhaust flange from carton.
2. Place the top fan exhaust flange on the top of air conditioner.
3. Use screws (enclosed inside of box with the top fan exhaust flange) to install the top fan exhaust flange on air conditioner as shown in Figure 2.

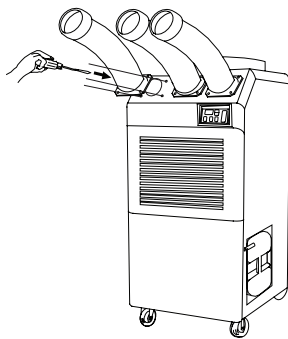

Figure 3

Discharge Ducts /Supply Air Duct

1. Remove cool air outlet hose(s) from carton.
2. Place the cool air outlet hose(s) on the front top of air conditioner.
3. Use screws (enclosed inside of box with cool air outlet hose(s) to install the cool air outlet hose(s) on the air conditioner as shown in Figure 3.

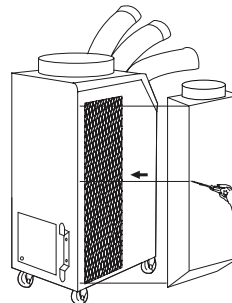

Figure 4

Condenser Plenum (Optional)

Condenser Plenum can be purchased separately. Condenser Plenum fits over the condenser to duct condenser air to the unit to improve cooling efficiency.

1. Remove Condenser Plenum from carton.
2. Place Condenser Plenum on the side of air conditioner.
3. Use screws (enclosed inside of box with Condenser Plenum) to install the Condenser Plenum on the air conditioner as shown in Figure 4.

Model 5KK30-Submittal Data

Accessory Parts

Part Name	Part Number
Condensate pump kit (220V)	SA057-0073
Condenser plenum/return air adapter for 5KK30	SA076-4002
Remote Controller (26 ft with line)	SA076-4006
16 FT Temperature Sensor	SA076-4007
Cool air duct connecting flange (D5", L3")	SA076-4008
Long cool air duct assembly (D5", L40")	SA076-4009
Condenser Discharge Kit	SA076-3645
Condenser return/discharge kit	SA076-3635
Replacement washable filte , evaporator	KWPCFLT-02E
Replacement washable filte , condenser	KWPCFLT-03C