

minicat

ULTRA LIGHT CATAMARAN





THE WORLD'S FAVORITE PORTABLE SAILBOAT

17 years ago our idea was to create an affordable sailboat, flexible, lightweight, easy to transport, fast to assemble & yet delivering a great sailing experience.

We designed, tested, improved, and tested again and finally created an innovative product that is hand-produced solely in the Czech Republic, the centre of Europe. Now there are over 3,000 MiniCats sailing all over the world.

MiniCat is a high-performance inflatable catamaran you can take on the plane with you when going on vacation, is easy to fit in any campervan, motorhome, RV or even a family car and is a great addition to your cruising yacht without the usual storage problems.

minicat
ULTRA LIGHT CATAMARAN



EASY TO TRANSPORT

ASSEMBLED SINGLE-HANDEDLY
IN 10 - 40 MINS

NO EXTRA TOOLS REQUIRED

REMOVE MAST, ADD OUTBOARD
& CREATE AN INSTANT TENDER

WIDE SELECTION OF ACCESSORIES
AVAILABLE



4 SIZES / 8 MODELS

FOR 1 - 4 PEOPLE TO SAIL

ALL MODELS FIT IN 1-3 BAGS

WEIGHT FROM 27-60 KGS

24 MONTH FULL PRODUCT
WARRANTY



**MINICAT
460**



460 Elite
page 23.

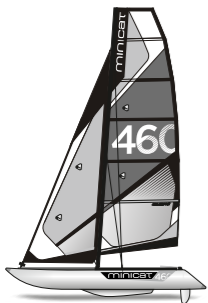

460 Esprit
page 21.

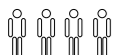

54 Kg

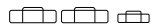

40 min

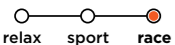

4600 mm

**MINICAT
420**



420
Laura Dekker
Edition
page 19.



420 Emotion
page 15.

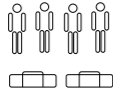

52 Kg

30 min



4200 mm



420 Evoque
page 17.



420 Instinct
page 13.



relax sport race

**MINICAT
310
SPORT**



page 11.



32,5 Kg

15 – 20 min

3150 min



relax sport race

**MINICAT
GUPPY**



page 9.



27 Kg

10 – 12 min

3000 min

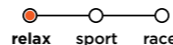

relax sport race



MINICAT



GUPPY is all about simplicity and speed of assembly. Due to the unique design of the floats pre-attached to the frame, set-up takes just 10 mins, start to finish. This model features a flexible composite mast simply fixed in the frame with no anchoring lines. This makes the boat much safer in strong winds as the mast flexes and prevents the sailor from capsizing.

Guppy is also exceptionally light (just 27 kg) and the funky design of the sail and lack of jib makes this dinghy sailboat especially appealing to first-time junior sailors who want to learn sailing techniques and have fun. Guppy is also perfect for sailors looking for an instant sailing fix, from car to water in 15mins.

OPTIONS & TECH

length	3000 mm
width	1500 mm
height of the mast	4150 mm
weight	27 kg
diameter of floats	390 mm
sail	4,5 m ²
trampoline	1600 / 1450 mm
dimensions of the bag	1650 x 300 x 300 mm
design category	'D'
carrying capacity	240 kg
number of persons	2
time of assembly / dismantling	10 –12 min.

DIMENSIONS

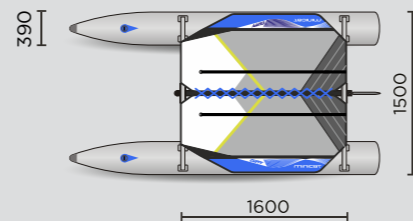
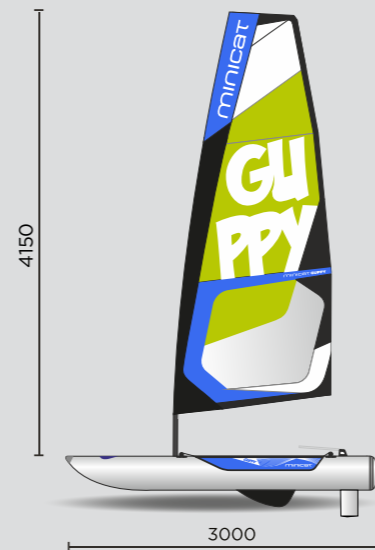

MINICAT 310 SPORT

With the 310 floats pre-attached to the main frame and trampoline, the set-up of the new generation MiniCat 310 Sport can be achieved in just 15-20 mins. At only 32.5 kg portability and performance are both increased. Designed for individual sailors who like speed and performance or families seeking a compact and safe sailboat, the MiniCat 310 Sport is perfect for all who want to get out on the water quickly and as a yacht accessory requiring fast on-deck assembly.



OPTIONS & TECH

length	3150 mm
width	1400 mm
height of the mast	3800 mm
weight	32,5 kg
diameter of floats	390 mm
sail	main sail+jib
main sail	3,75 m ²
jib	1,5 m ²
trampoline	1350x950 mm
dimensions of the bag	1600x320x360 mm
design category	'D'
carrying capacity	240 kg
number of persons	2
time of assembly / dismantling	15 – 20 min.

DIMENSIONS

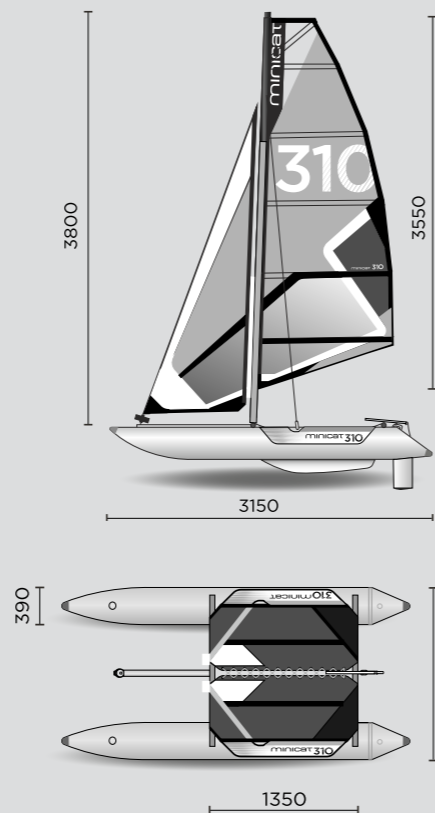

MINICAT 420 INSTINCT

The 420 Instinct is the perfect family boat that excels with its exceptional stability and simplicity. The practical batten-wired Dacron sail is designed without a boom, which provides greater comfort and safety of all crew members, especially children. This model can be completed with the optional rolling sail GENNA.



OPTIONS & TECH

length	4200 mm
width	2100 mm
height of the mast	5050 mm
weight	52 kg
diameter of floats	450 mm
sail	main sail+jib
main sail	6.5 m ²
jib	3.2 m ²
trampoline	1900x1350 mm
dimensions of the bag	2x 1750x300x300 mm
design category	'D'
carrying capacity	450 kg
number of persons	4
time of assembly / dismantling	30 min.

DIMENSIONS

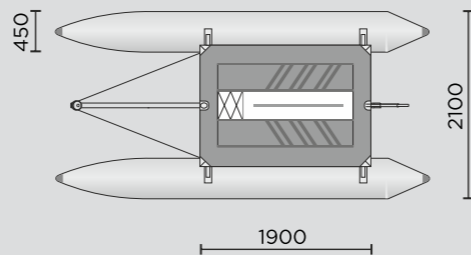
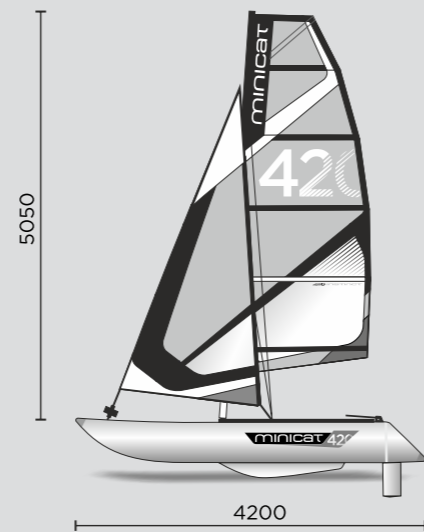

MINICAT 420 EMOTION

The perfect sports boat, built for the pleasure of sailing fast. The 420 Emotion offers a true sporting experience, but also surprises with its' versatility. The main sail of transparent monofilm is controlled by an aluminum boom. This enables the optimal sail profile settings to achieve maximum performance and speed. This model can be completed with the optional rolling sail GENNA.



OPTIONS & TECH

length	4200 mm
width	2100 mm
height of the mast	5050 mm
weight	52 kg
diameter of floats	450 mm
sail	main sail+jib
main sail	6.5 m ²
jib	3.2 m ²
trampoline	1900x1350 mm
dimensions of the bag	2x 1750x300x300 mm
design category	'D'
carrying capacity	450 kg
number of persons	4
time of assembly / dismantling	30 min.

DIMENSIONS

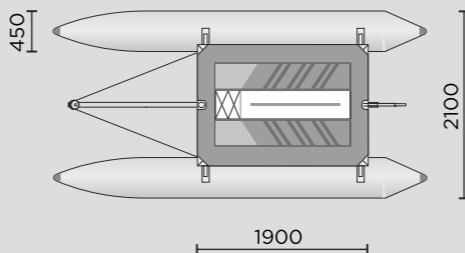
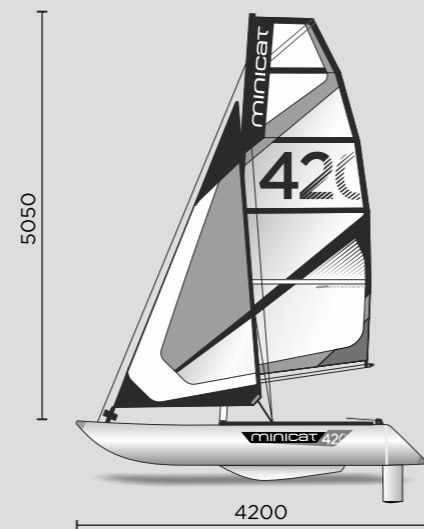

MINICAT 420 EVOQUE

An exciting, sporty, adrenalin-filled ride!
The 420 Evoque is created in a unique style from hi-tech materials. With the prominent parts from carbon fibre with black frame and sails, this boat performs as it looks. Fast, sleek, stylish & cool. This model can be completed with the optional carbon mast and rolling sail GENNA.



OPTIONS & TECH

length	4200 mm
width	2100 mm
height of the mast	5050 mm
weight	52 kg
diameter of floats	450 mm
sail	main sail+jib
main sail	6.5 m ²
jib	3.2 m ²
trampoline	1900x1350 mm
dimensions of the bag	2x 1750x300x300 mm
design category	'D'
carrying capacity	450 kg
number of persons	4
time of assembly / dismantling	30 min.

DIMENSIONS

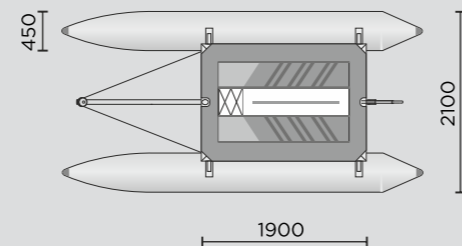
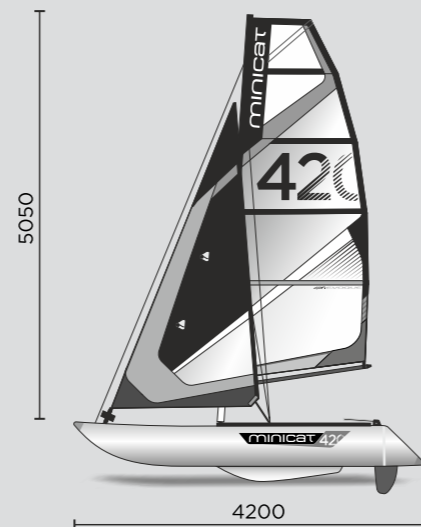

CARBON COMPONENTS: RUDDER, BOOM, BOWSPRIT



MINICAT 420 Laura Dekker Edition

An exciting high-tech Special Edition MiniCat designed in cooperation with Laura Dekker - the youngest sailor to singlehandedly circumnavigate the world.

The design is based on MiniCat 420 Evoque using carbon fiber fittings, matt finish of the frame, duo-coloured mast, fantastic eye-catching design of sail & jib and trampoline with embroidered logo of Laura Dekker. The MiniCat 420 Laura Dekker appeals to sailors who like individuality, for those who seek a great, high-performance sailboat with a colourful, funky sail design. This model can be completed with the optional carbon mast and rolling sail GENNA.

by *Laura Dekker*

OPTIONS & TECH

length	4200 mm
width	2100 mm
height of the mast	5050 mm
weight	52 kg
diameter of floats	450 mm
sail	main sail+jib
main sail	6.5 m ²
jib	3.2 m ²
trampoline	1900x1350 mm
dimensions of the bag	2x 1750x300x300 mm
design category	'D'
carrying capacity	450 kg
number of persons	4
time of assembly / dismantling	30 min.

DIMENSIONS

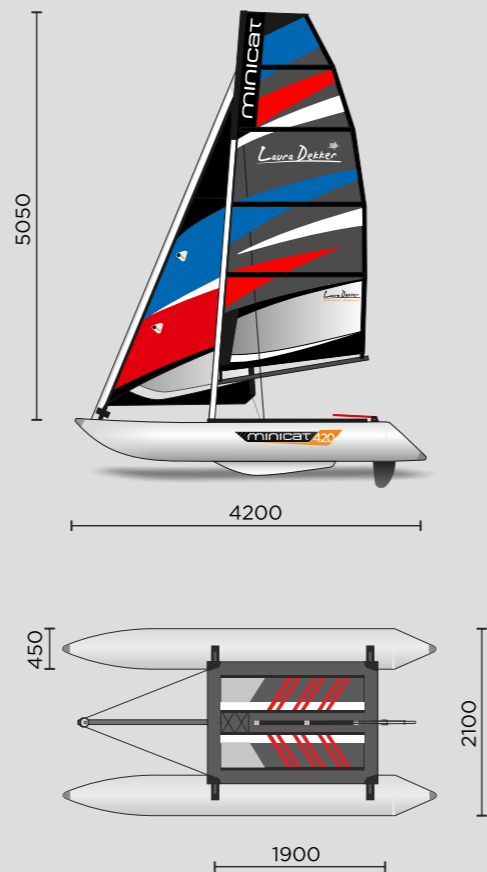

CARBON COMPONENTS: RUDDER, BOOM, BOWSPRIT



MINICAT 460 ESPRIT

460 is the largest and most powerful MiniCat. The potential of the 460 Esprit is for those who seek maximum performance, speed and exhilaration. This boat constantly surprises with the simplicity of its handling. Constructed of the latest materials and technology, the 460 Esprit is ultra-light weight and delivers an exceptional sailing experience. This model can be completed with the optional carbon mast and rolling sail GENNA.



OPTIONS & TECH

length	4600 mm
width	2200 mm
height of the mast	6100 mm
weight	58 kg
diameter of floats	490 mm
sail	main sail+jib
main sail	8.0 m ²
jib	3.5 m ²
trampoline	1900x1450 mm
dimensions of the bag	2x 1750x300x300 mm + 1000x300x300 mm
design category	'D'
carrying capacity	450 kg
number of persons	4
time of assembly / dismantling	40 min.

DIMENSIONS

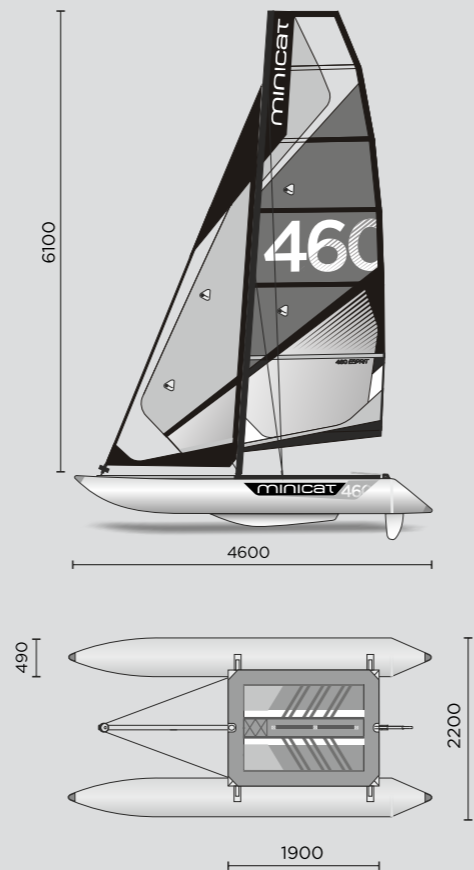

MINICAT 460 ELITE

The 460 Elite is a high-tech edition to the largest category of MiniCat and its name really says it all. Based on the MiniCat 460 Esprit, designed for experienced sailors the 460 Elite takes the 460 range to a new level of style, class and performance through the use of an ultra-light carbon fiber mast, rudder and bowsprit together with some eye-catching details of embroidery on the trampoline. 460 Elite is a serious boat for serious sailors! This model can be completed with rolling sail GENNA.



OPTIONS & TECH

length	4600 mm
width	2200 mm
height of the mast	6100 mm
weight	54 kg
diameter of floats	490 mm
sail	main sail+jib
main sail	8.0 m ²
jib	3.5 m ²
trampoline	1900x1450 mm
dimensions of the bag	2x 1750x300x300 mm + 1000x300x300 mm
design category	'D'
carrying capacity	450 kg
number of persons	4
time of assembly / dismantling	40 min.

DIMENSIONS

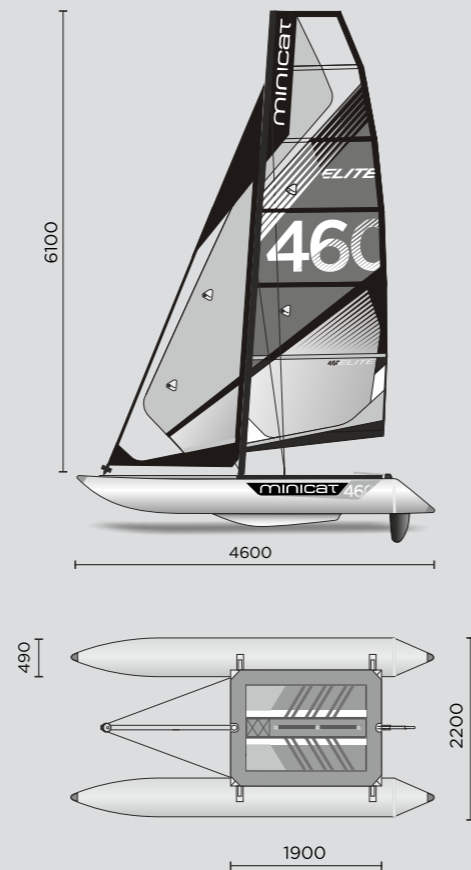

CARBON COMPONENTS: MAST, RUDDER, BOOM, BOWSPRIT



1.



2.



3.



4.



5.



6.



7.



8.



9.



10.



11.



- 1. Compressor powered by car battery
- 2. Telephone case
- 3. Waterproof sacks 5l / 12l / 20l / 40l
- 4. Telescopic paddle
- 5. Ladder



minicat **GUPPY**

minicat **310**

minicat **420**

minicat **460**

- 6. Trapeze kit
- 7. Windmeter
- 8. Pressure gauge
- 9. Wind flag
- 10. Engine support
- 11. Mast float



ACCESSORIES & SPARE PARTS



12.



15.



16.



17.



13.



14.



19.



18.

- 12. Carbon mast
- 13. Rechargable battery compressor
- 14. Wheelie bag
- 15. Transport trolley
- 16. Float support
- 17. Inflatable seats
- 18. Additional trampoline
- 19. Storm sail
- 20. Protective cover

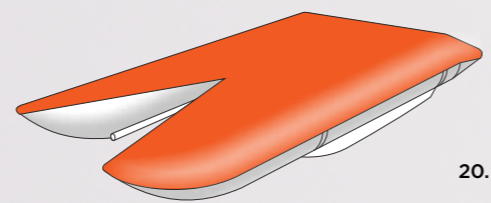

20.

minicat GUPPY	minicat 310	minicat 420	minicat 460
---------------	-------------	-------------	-------------



ROLLING SAIL GENNA



The construction of this brand-new sheet is based on the “Code Zero” type of sails and comes equipped with furler, so a snuffer is not required as it can be rolled back in similar style as the jib is.

This special sail enables you to sail not only on the tailwind, but also on the crosswind and even slightly against the wind. It comes in two sizes for M460 and M420 and is an optional accessory.

The area of the Rolling sail GENNA:



M420 - 7.9 m²



M460 - 9.9 m²



LAURA DEKKER

MiniCat Brand Ambassador



A TRULY INSPIRATIONAL YOUNG WOMAN, Laura needs no introduction, the youngest person ever to sail solo around the world. After a highly publicised court battle in the Netherlands closely followed by the world's media, Laura completed her solo circumnavigation aged just 16. Having first sailed a MiniCat whilst on her voyage Laura has become a MiniCat fan, a MiniCat owner, a MiniCat ambassador and a close friend. We are proud to actively support 'The Laura Dekker World Sailing Foundation' and to work with Laura and her family to make this great project a success. LDWSF take teenagers on trans-Atlantic ocean voyages to challenge them, teach them life-skills as well as sailing skills and open their eyes to the world (beyond digital).



AMBASSADOR





A GREAT TENDER FOR CRUISING YACHTS & FANTASTIC ADDITION FOR YOUR CAMPING AND SAILING HOLIDAYS.



VERSATILITY OF MINICAT



MINICAT MODEL OVERVIEW

	GUPPY	SPORT	INSTINCT	EMOTION	EVOQUE	LAURA DEKKER	ESPRIT	ELITE
MODELS		310				420		460
Number of persons	2	2	4	4	4	4	4	4
Length (cm)	300	315	420	420	420	420	460	460
Weight (kg)	27	32,5	52	52	52	52	58	54
Bags	1	1	2	2	2	2	3	3
Time of assembly (min.)	12	20	30	30	30	30	40	40
Main sail (m ²)	4,5	3,75	6,5	6,5	6,5	6,5	8,0	8,0
Jib	-	1,4	3,2	3,2	3,2	3,2	3,5	3,5
Sail material	Dacron	Dacron	Dacron	Monofilm	Monofilm X-Ply	X-Ply Carbon	X-Ply Carbon	X-Ply Carbon
Roll. Genna (add.)	-	-	yes	yes	yes	yes	yes	yes
Boom	-	-	-	alu	carbon	carbon	-	-
Jib Furler	-	yes	yes	yes	yes	yes	yes	yes
Engine support	yes	yes	yes	yes	yes	yes	yes	yes



MATERIALS & DESIGN

MAST

Made of aluminum alloy with teardrop profile. Composed of 3 parts (310 + 420) or of 4 parts (460). 3-part flexible composite mast for GUPPY.



SAILS

Sail materials are made from: Dimension Polyant - Dacron, Monofilm, Racing polyester X-PLY line.

FRAME

Frames are foldable and made from profiles of strengthened aluminum alloy that guarantees very low weight.

RUDDER

Depending on the model the rudder is made from aluminum, GRP produced by epoxy technology RTM or carbon fibre.

KEEL FINS

Both floats are fitted with keel fins in order to keep the direction and avoid the leeway.

All MiniCats are hand-produced in the EU with only European materials and according to EU standards and norms.



WORLDWIDE DISTRIBUTOR:

MORAVIAN EXPORTS, s.r.o.
trading as:

MINICAT WORLDWIDE
Czech Republic, Europe

tel: +420 776 749 175
info@minicatamaran.eu
www.minicatamaran.eu



Company registered
in Czech Republic

 @minicatamaran

 /minicat

 @minicatsailing

 search: MiniCat



**YOUR LOCAL
DISTRIBUTOR:**

