

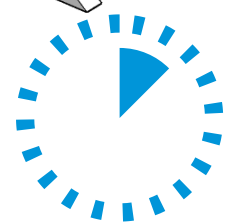

TABLETOP
SCENICS

TTSCW-HBA-009
SPINDLE DICE TOWER

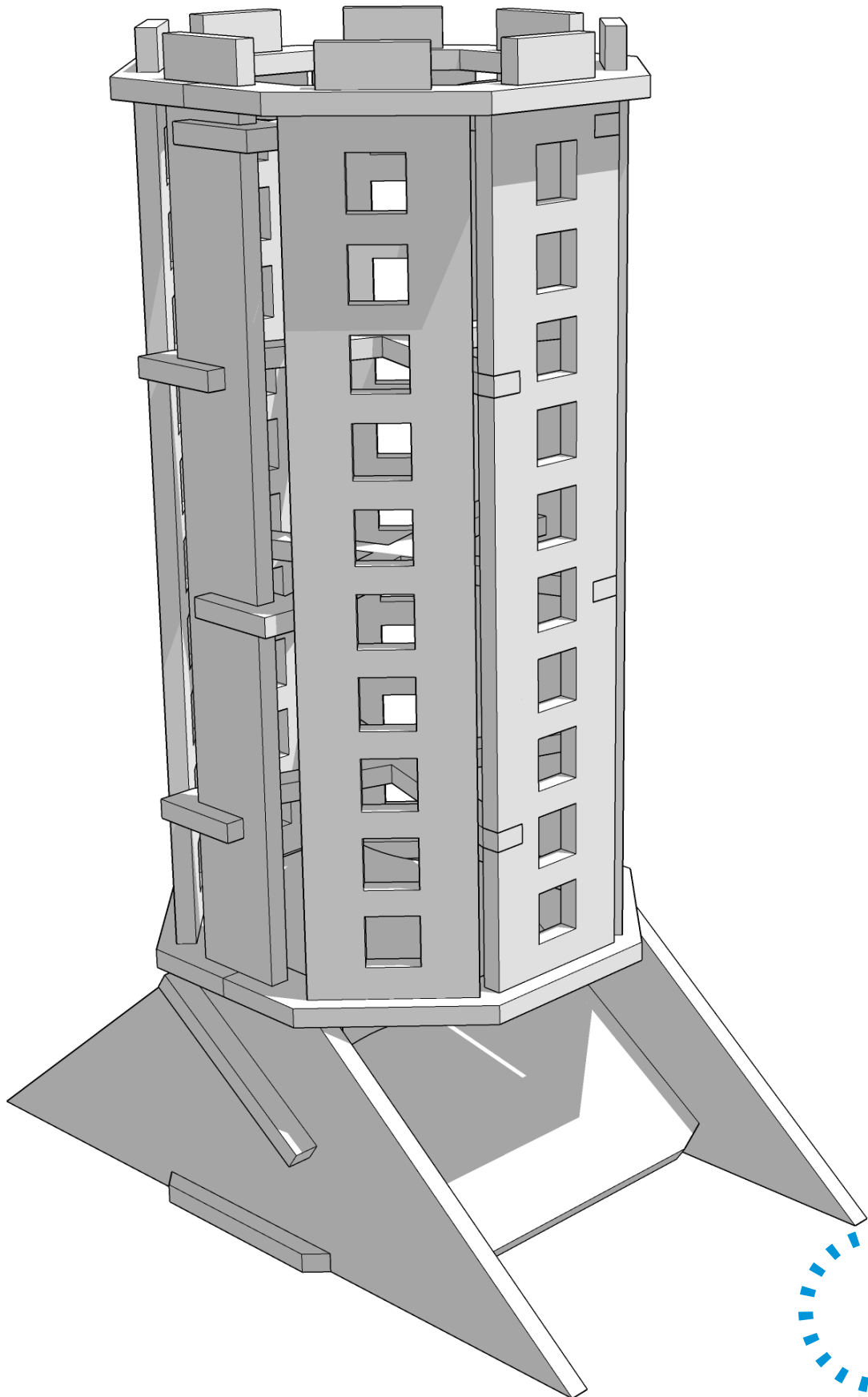

 **TTCOMBAT**



TABLETOP SCENICS

TTSCW-HBA-009 SPINDLE DICE TOWER

2

These are a series of icons that may be used throughout the instructions to help your assembly.
If in doubt, scroll ahead to confirm.



Do not glue this part



Carefully score and
fold this part

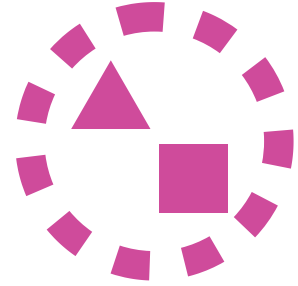

This part - or its placement is
completely optional

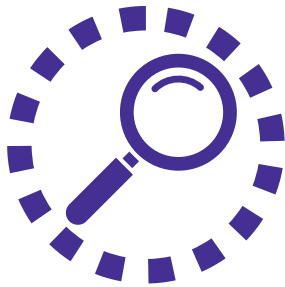

Look closely at this step -
The process order or part
used, may be specific



Repeat making this part
the specified number
of times

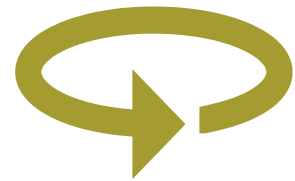

The next instruction step
will be the same assembly
so far, but from a different
angle

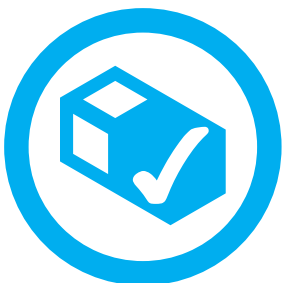

Sub-assembly complete.
This smaller construction
is ready to add to the
main kit



Assembly Complete! There
could be more optional
parts - check to the very end
of instructions



FRAGILE: DO NOT BEND.
“Bendy wood” is designed to
curve around a designed
frame only.



3

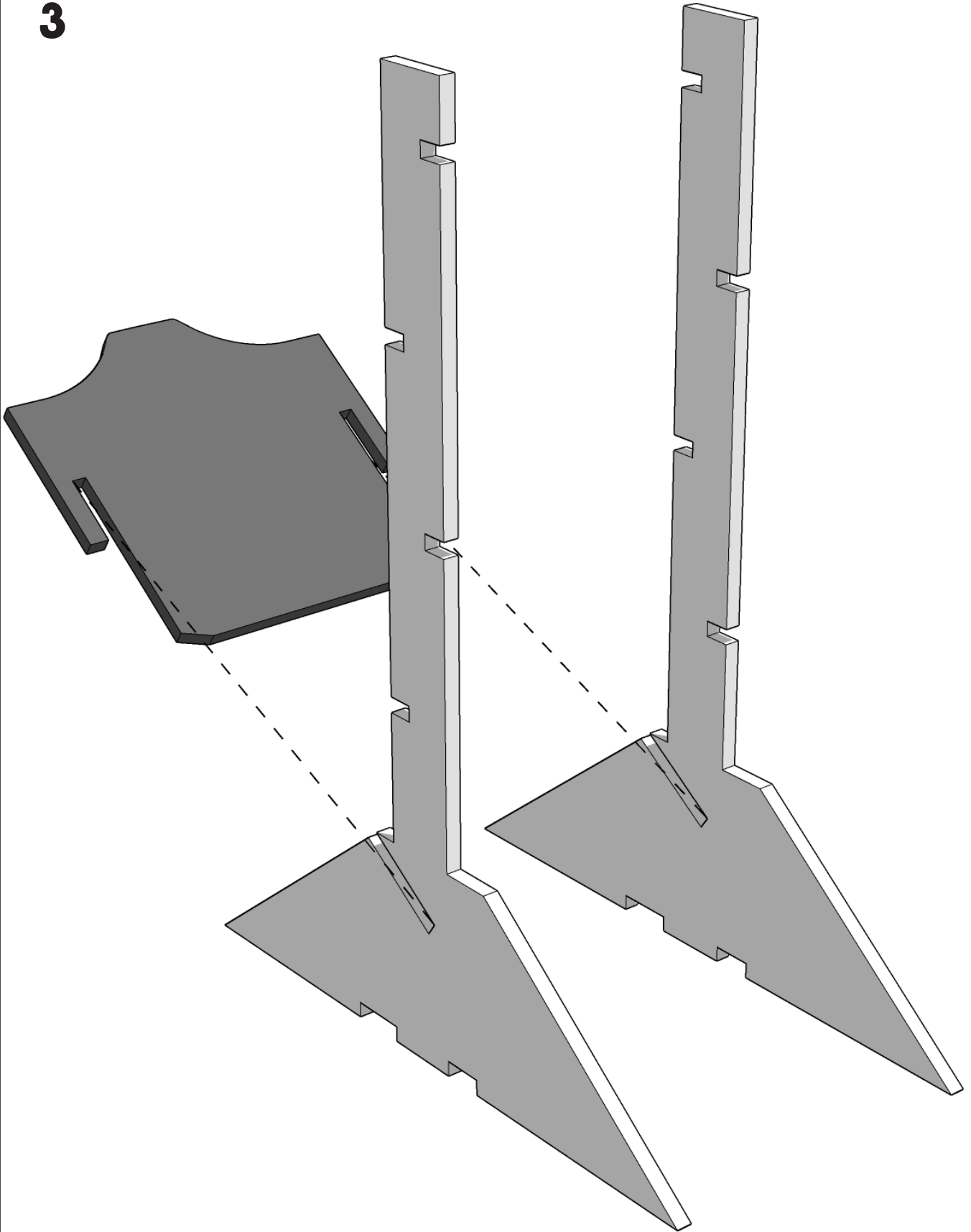



TABLETOP SCENICS

TTSCW-HBA-009
SPINDLE DICE TOWER

4

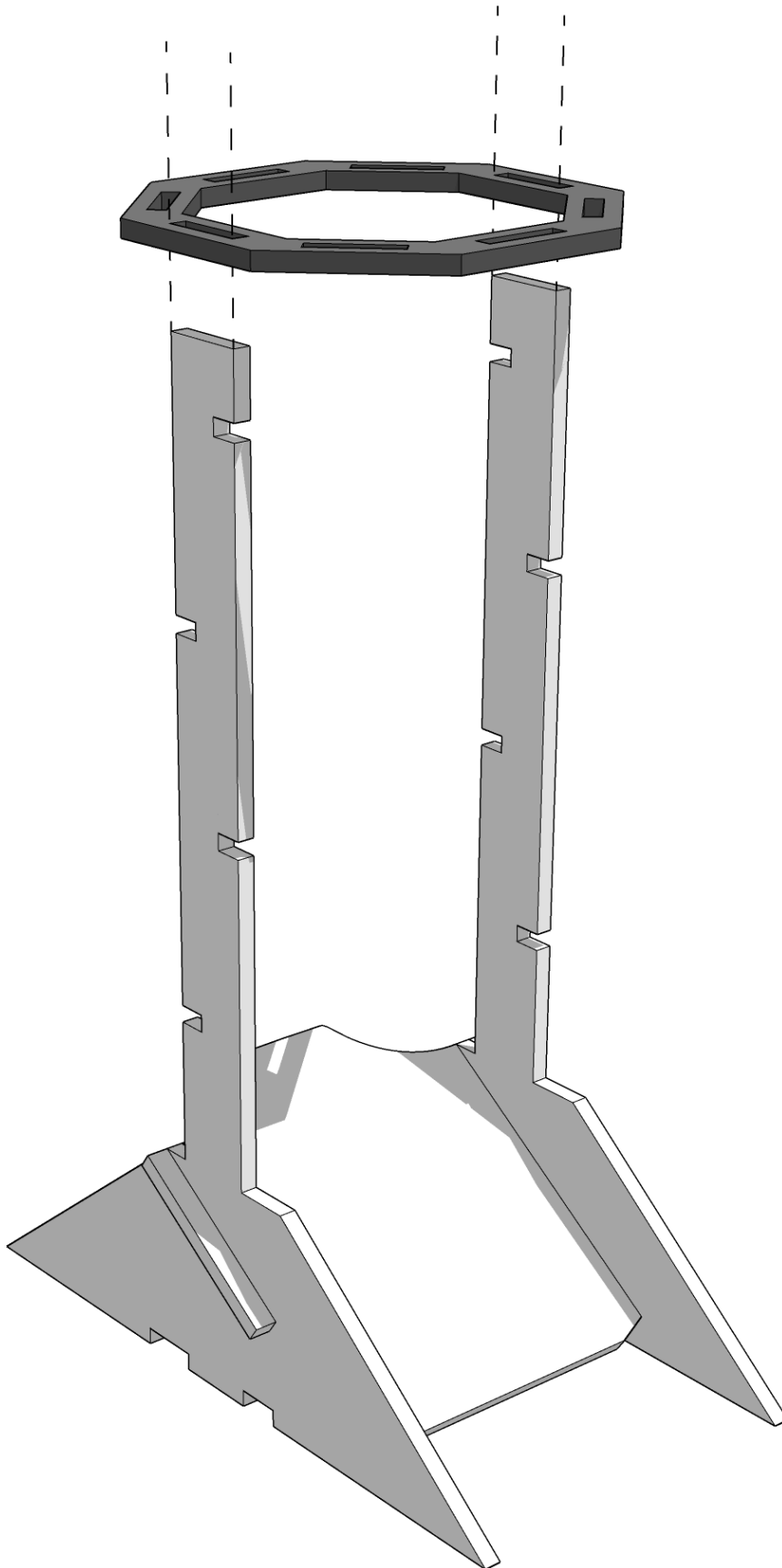



TABLETOP SCENICS

TTSCW-HBA-009
SPINDLE DICE TOWER

5

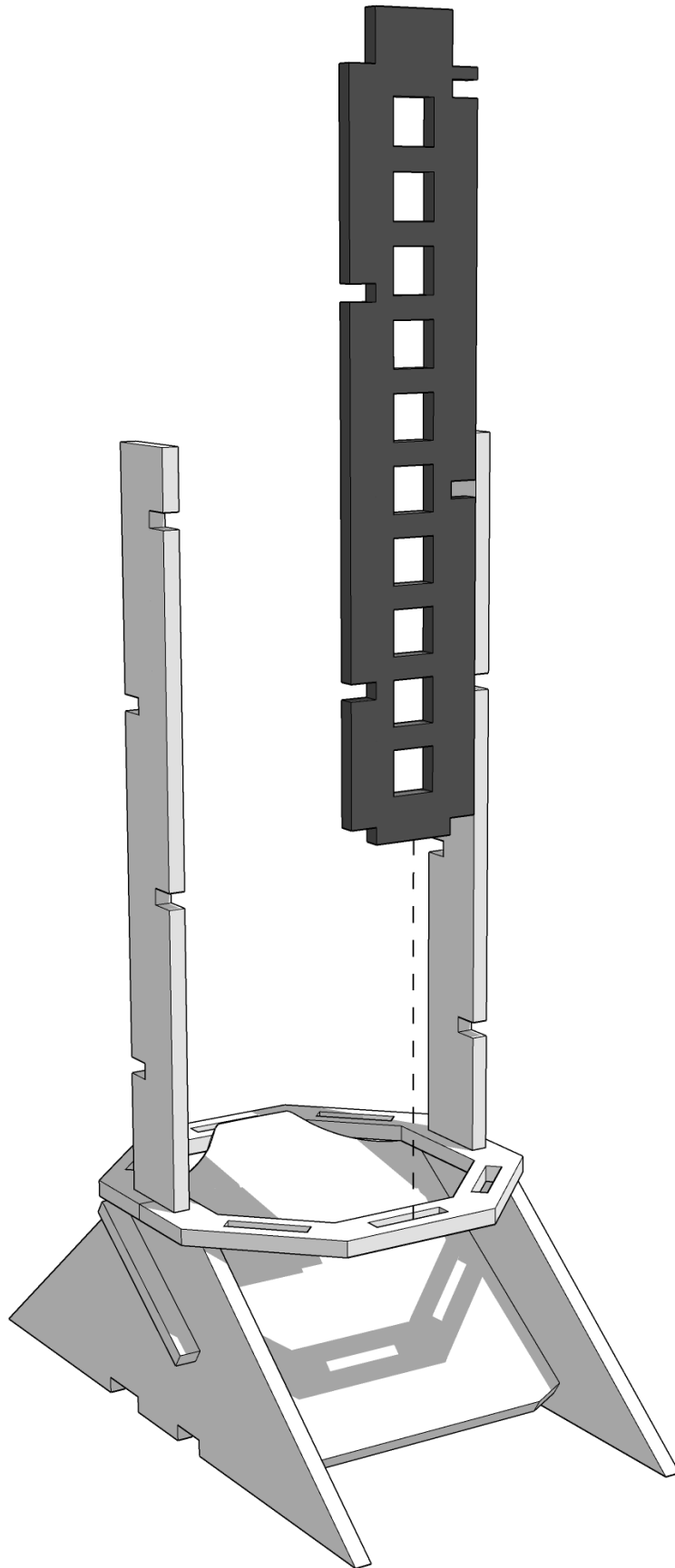



TABLETOP SCENICS

TTSCW-HBA-009
SPINDLE DICE TOWER

6

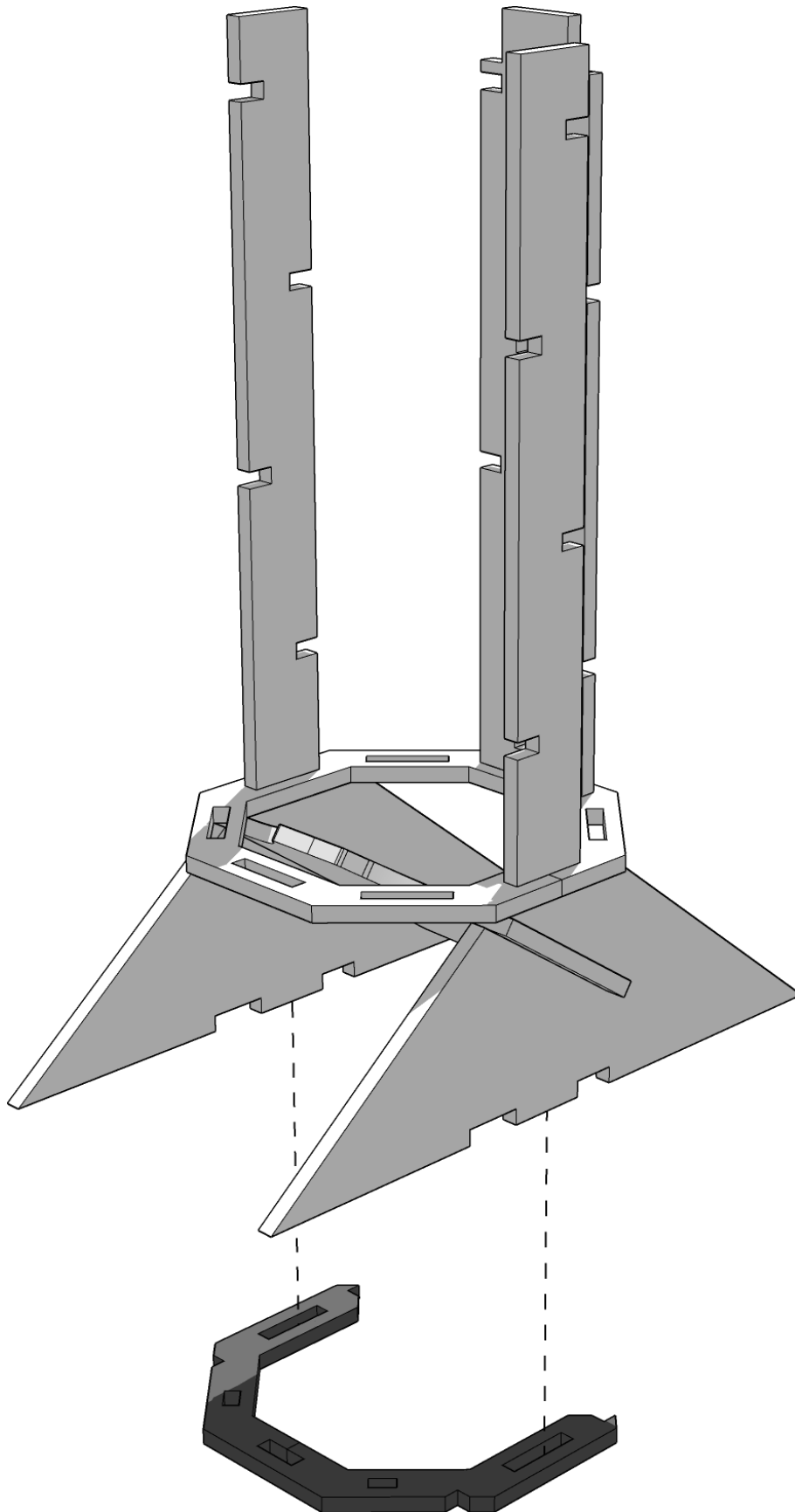



TABLETOP SCENICS

TTSCW-HBA-009
SPINDLE DICE TOWER

7

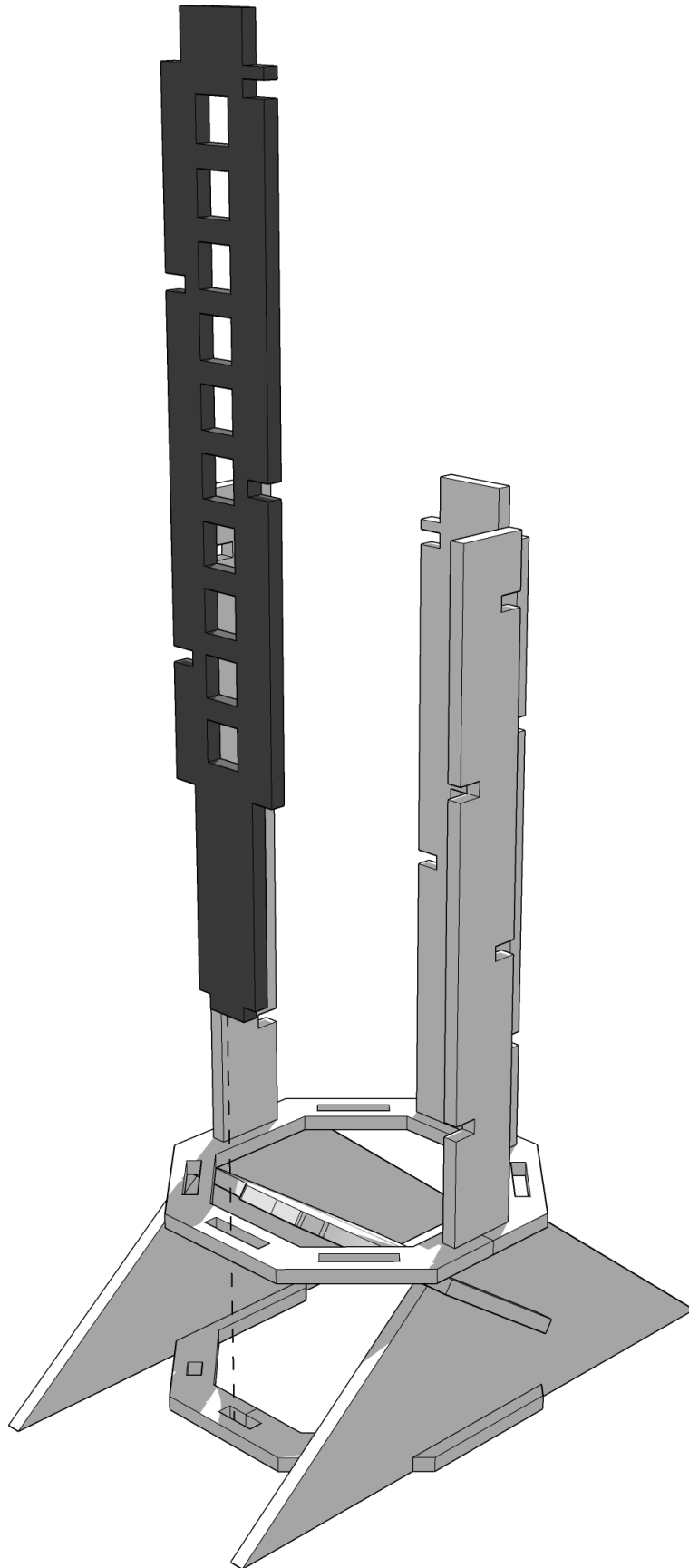



TABLETOP SCENICS

TTSCW-HBA-009
SPINDLE DICE TOWER

8

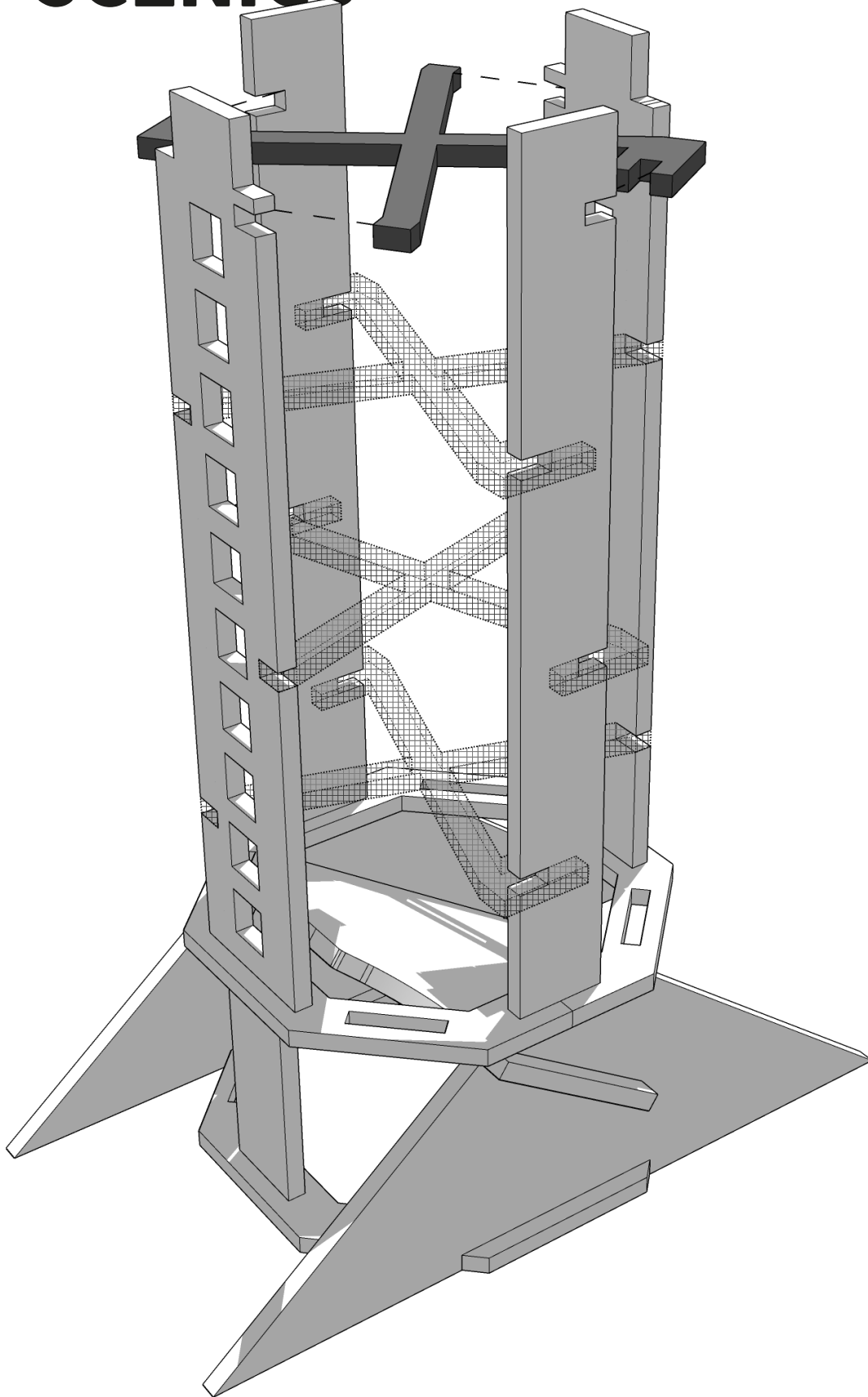



TABLETOP SCENICS

TTSCW-HBA-009
SPINDLE DICE TOWER

9

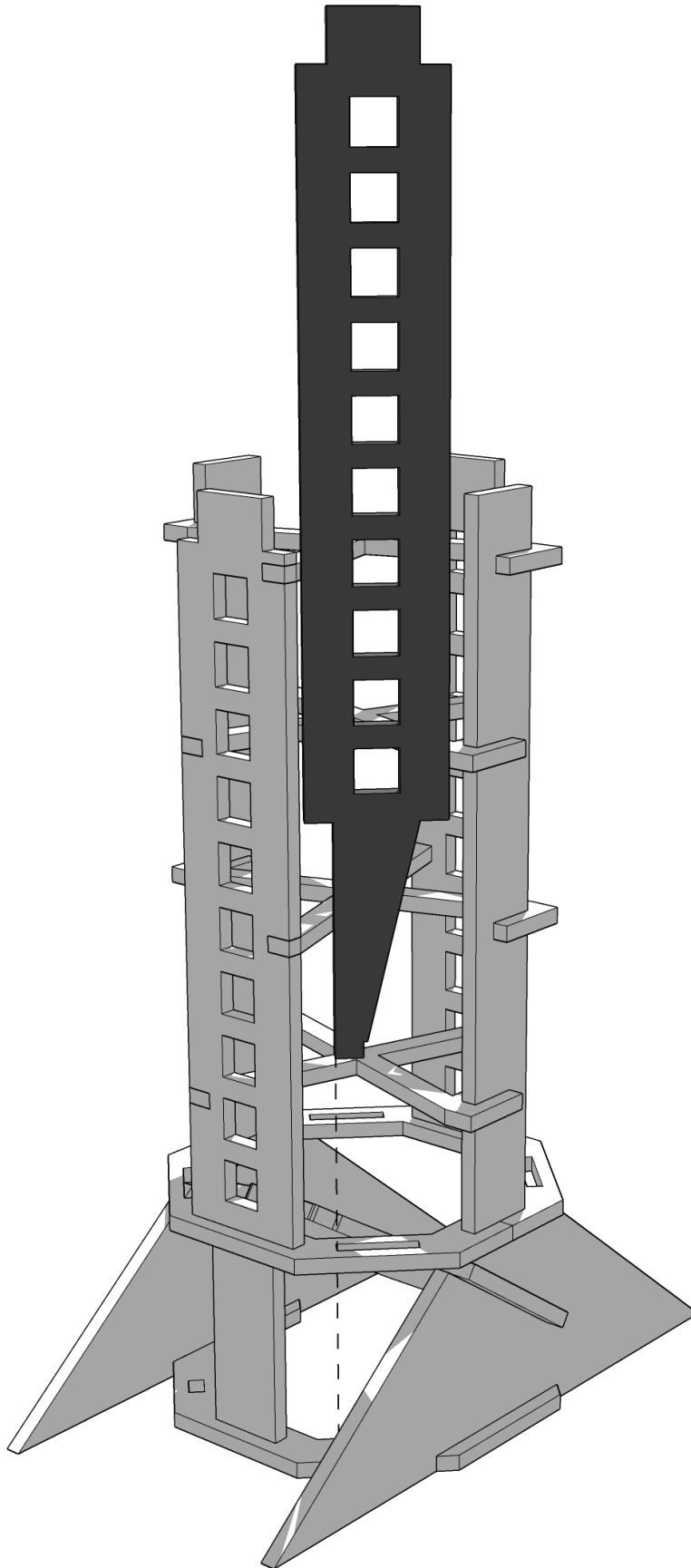



TABLETOP SCENICS

TTSCW-HBA-009
SPINDLE DICE TOWER

10

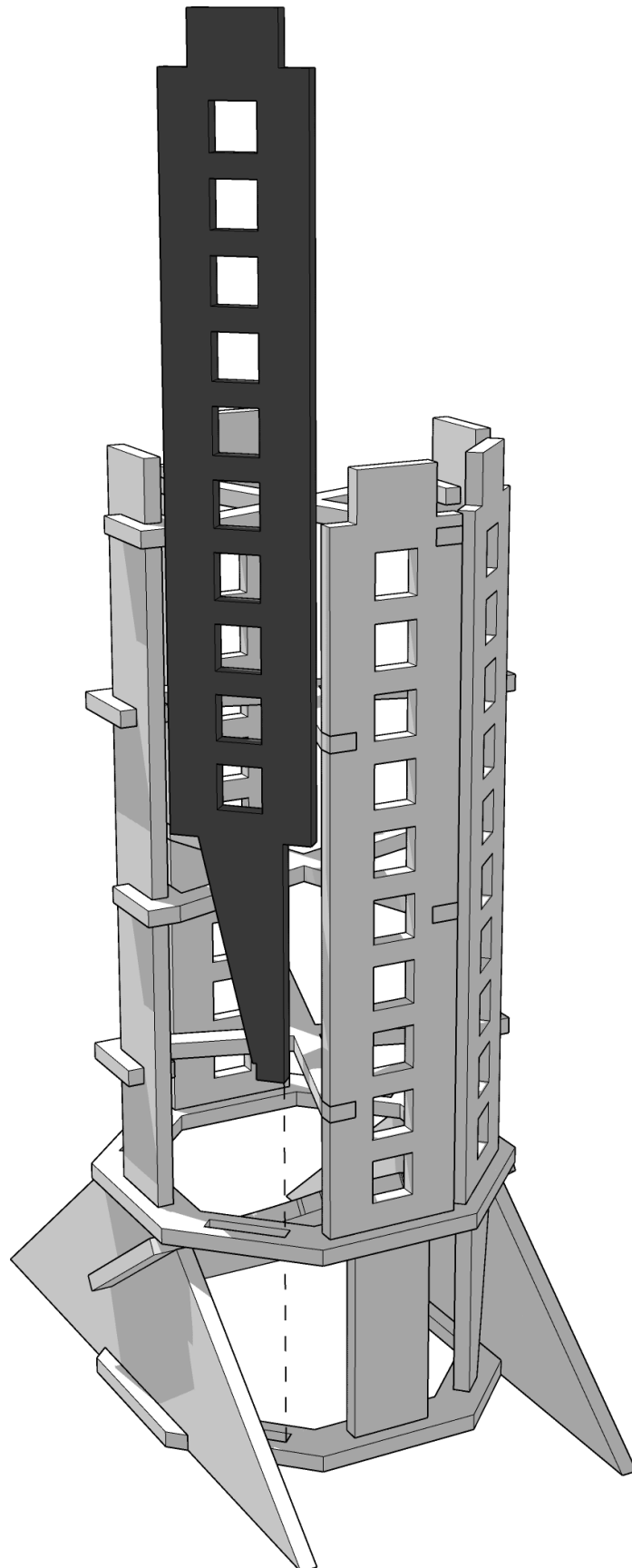



TABLETOP SCENICS

TTSCW-HBA-009
SPINDLE DICE TOWER

11

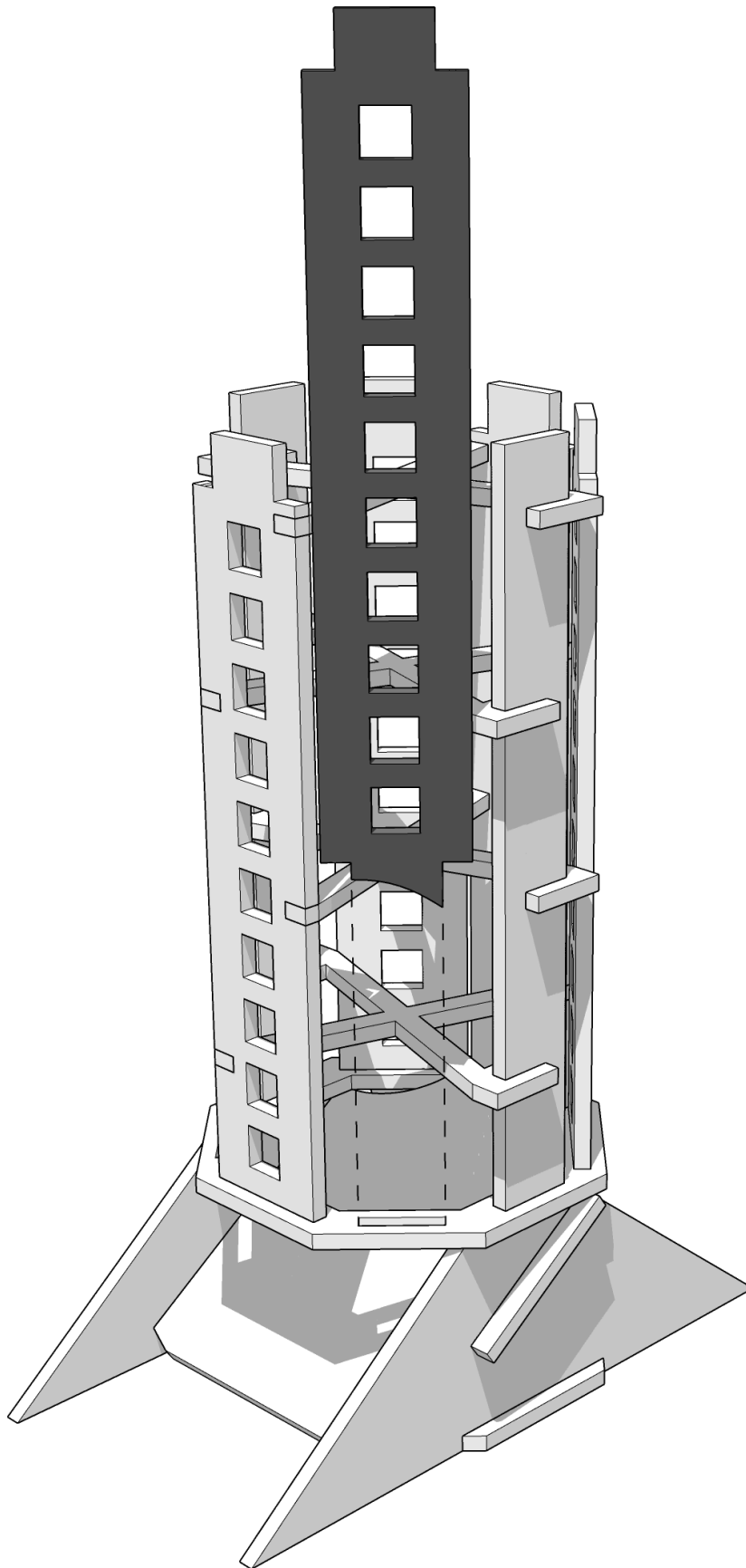



TABLETOP SCENICS

TTSCW-HBA-009
SPINDLE DICE TOWER

12

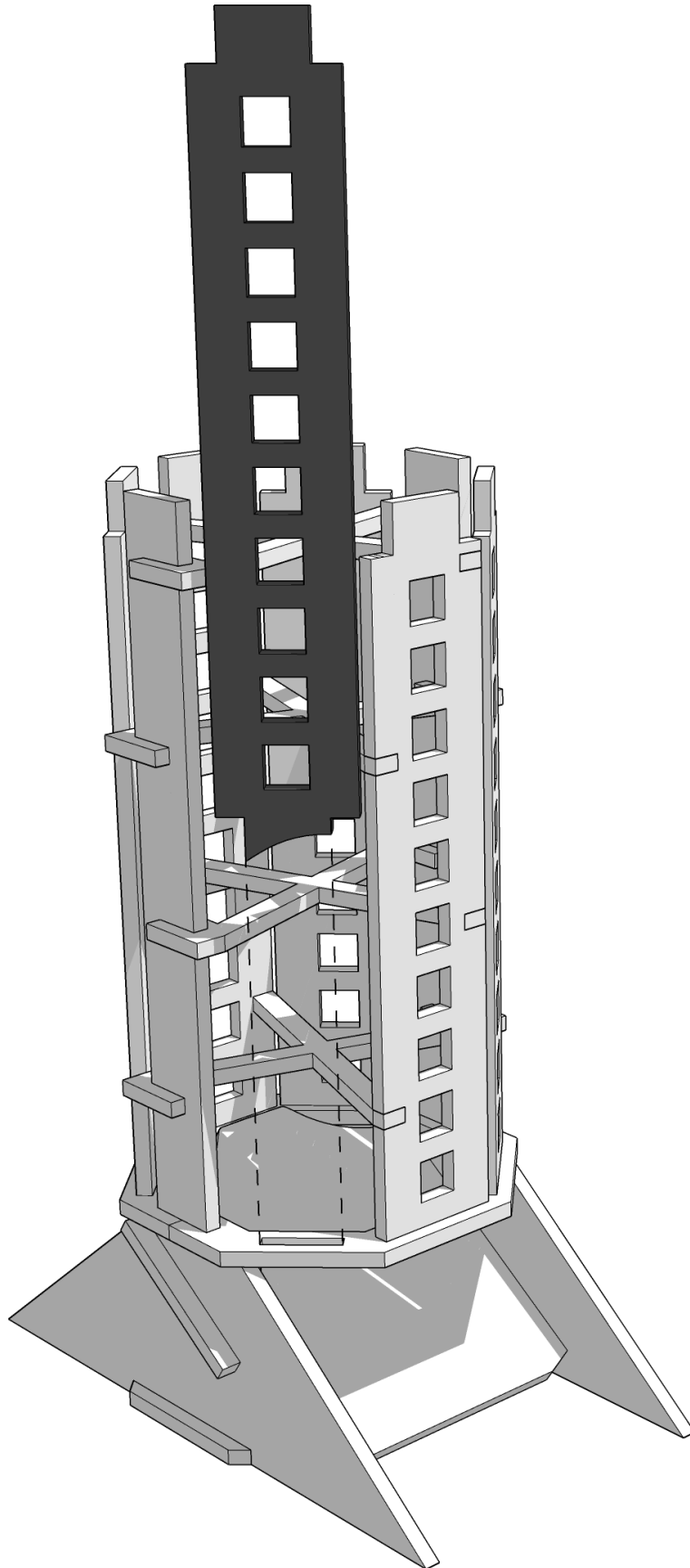



TABLETOP SCENICS

TTSCW-HBA-009
SPINDLE DICE TOWER

13

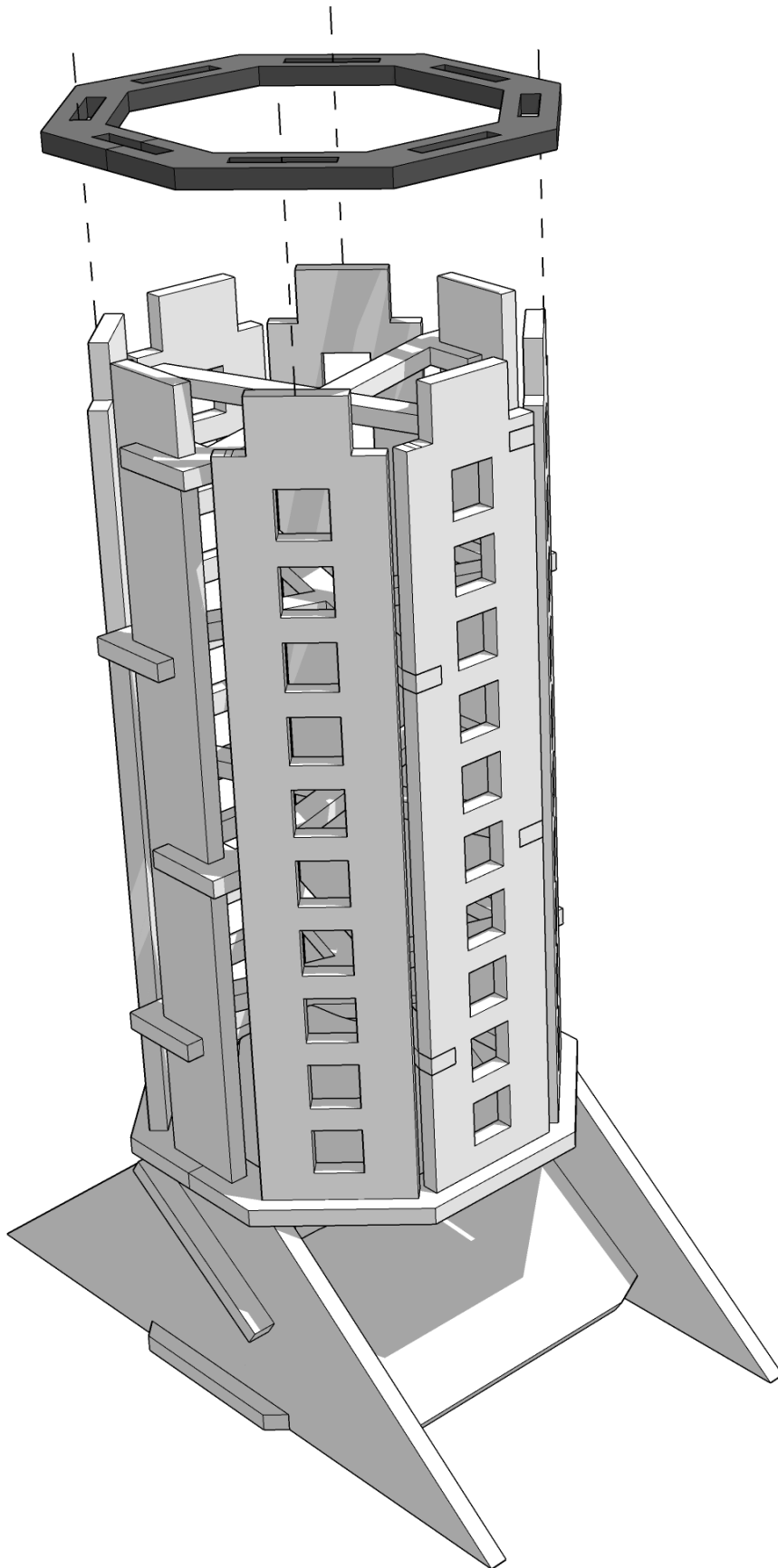



TABLETOP SCENICS

TTSCW-HBA-009
SPINDLE DICE TOWER

14

