



# TABLETOP SCENICS

## TTSC-WAR-O83 City, Corner & Delapidated Rowhouse Destroyed

These are a series of icons that may be used throughout the instructions to help your assembly:



Do not glue this part



Carefully score and  
fold this part

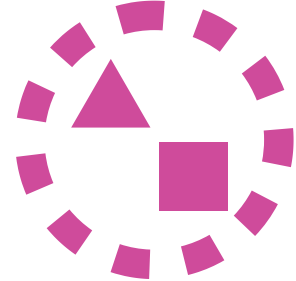

This part - or its placement is  
completely optional



Look closely at this step  
- its process order or part  
used may be specific



Repeat making this part  
the specified number  
of times

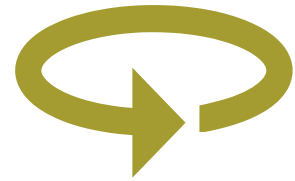

The next instruction step  
will be the same assembly so  
far but from a different  
angle

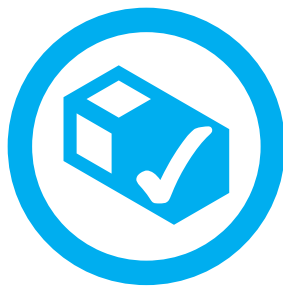

Sub-assembly complete.  
This smaller construction  
is ready to add to the  
main kit



Assembly Complete! There  
could be more optional  
parts - check to the very end  
of instructions





# TABLETOP SCENICS

**TTSC-WAR-O83**  
**City, Corner & Delapidated**  
**Rowhouse Destroyed**

**1**

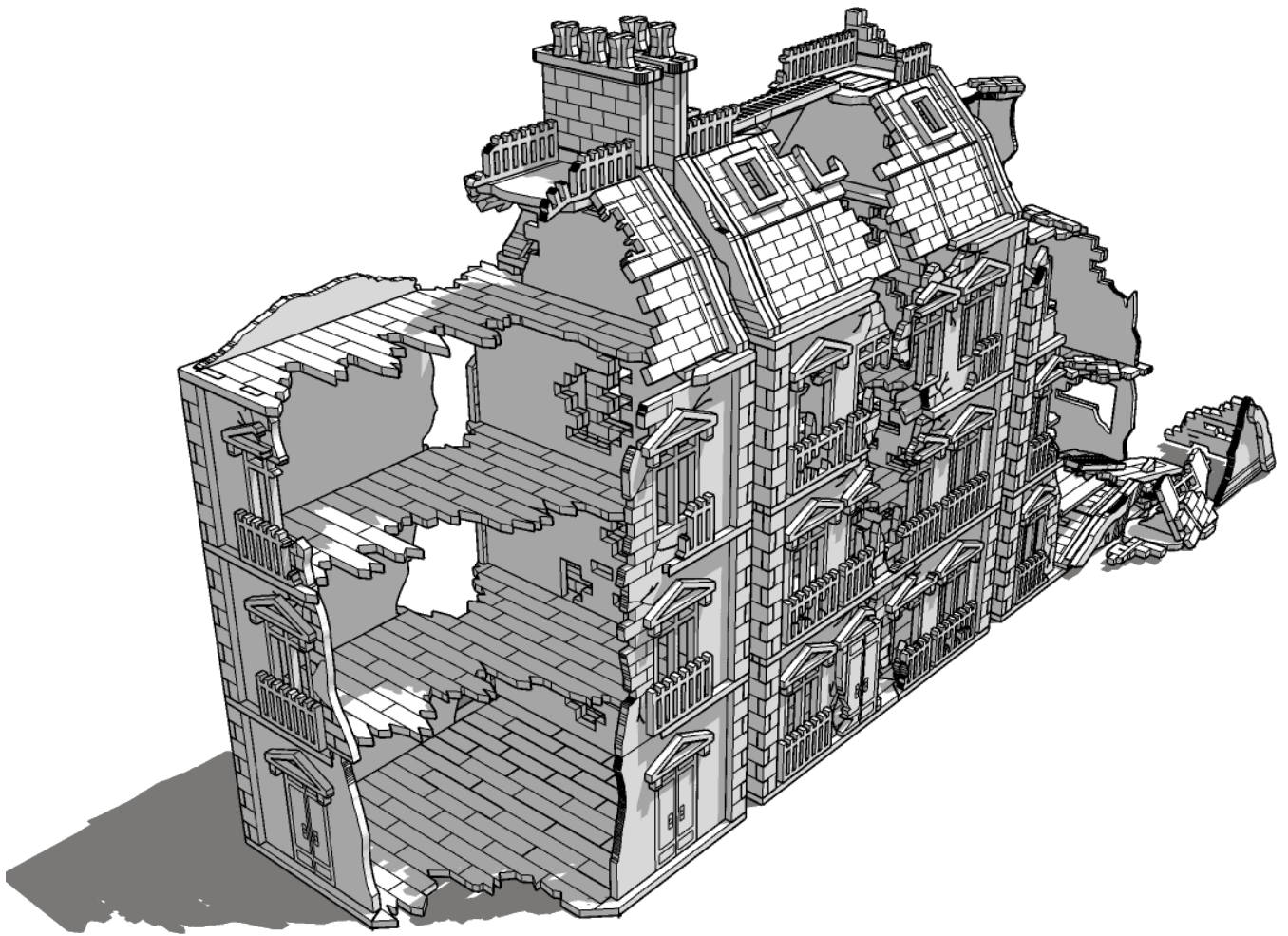



# TABLETOP SCENICS

**TTSC-WAR-O83**  
**City, Corner & Delapidated**  
**Rowhouse Destroyed**

**2**

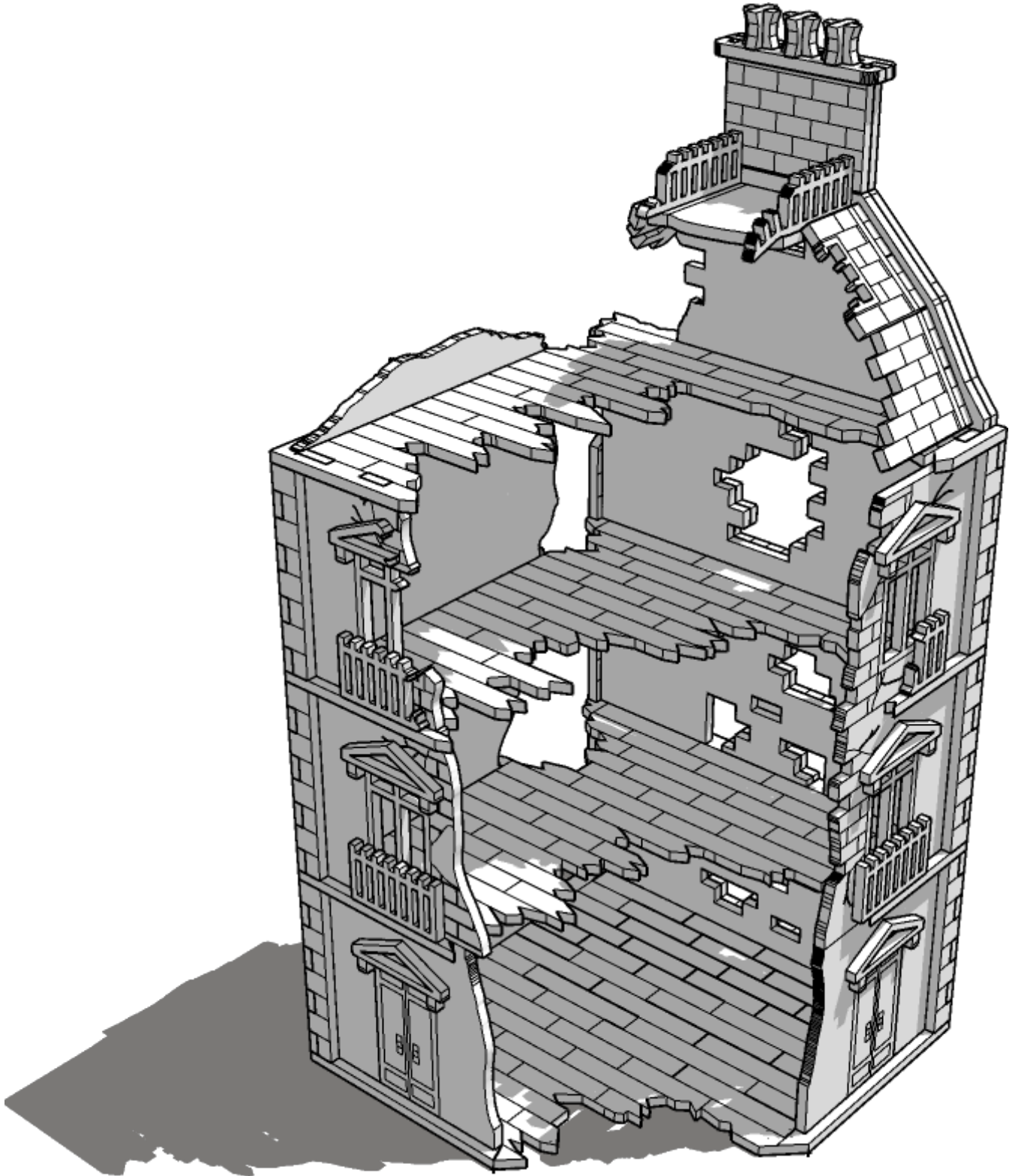



# TABLETOP SCENICS

**TTSC-WAR-O83**  
**City, Corner & Delapidated**  
**Rowhouse Destroyed**

**3**

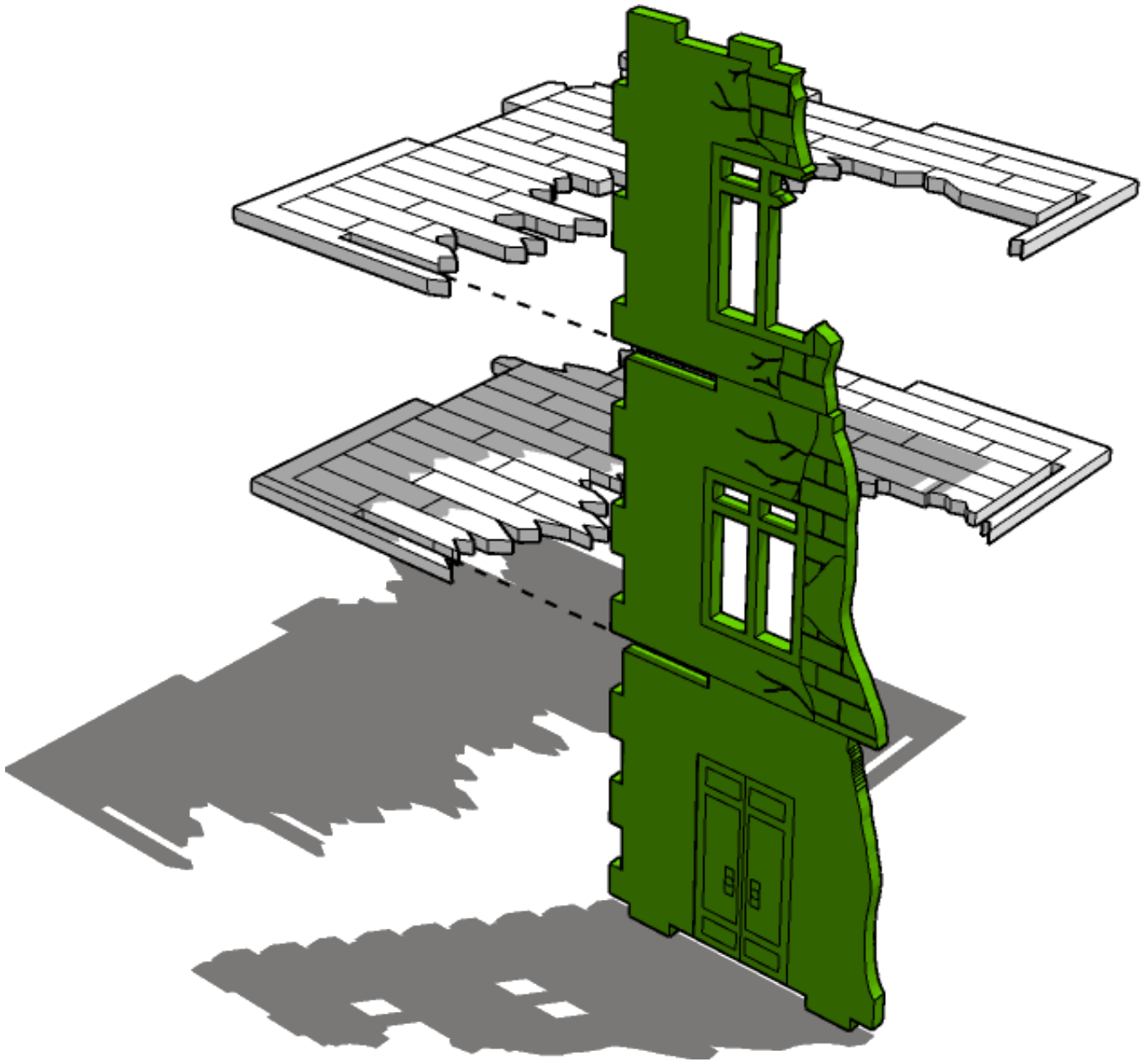



# TABLETOP SCENICS

**TTSC-WAR-O83**  
**City, Corner & Delapidated**  
**Rowhouse Destroyed**

**4**

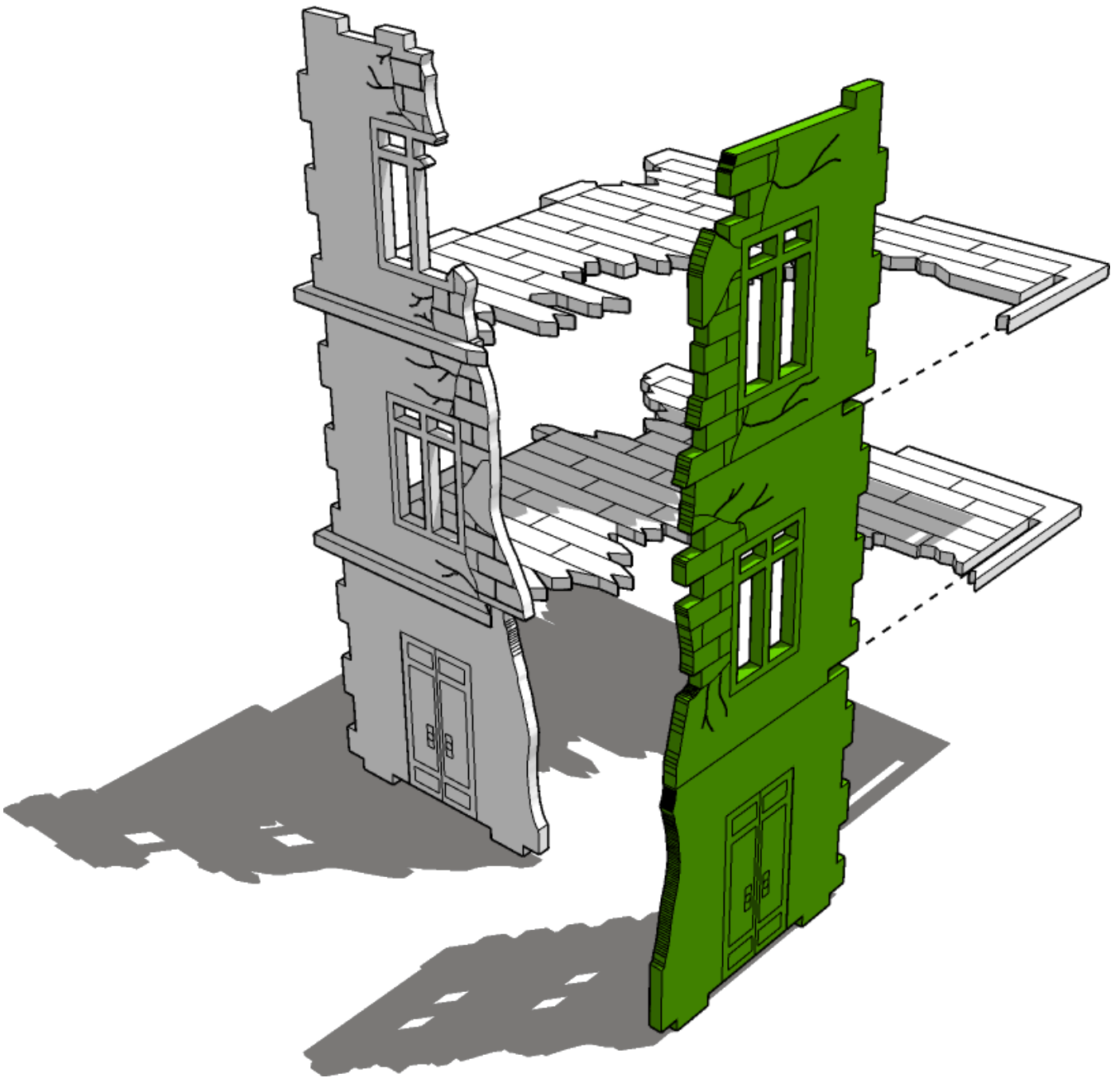



# TABLETOP SCENICS

**TTSC-WAR-O83**  
**City, Corner & Delapidated**  
**Rowhouse Destroyed**

**5**

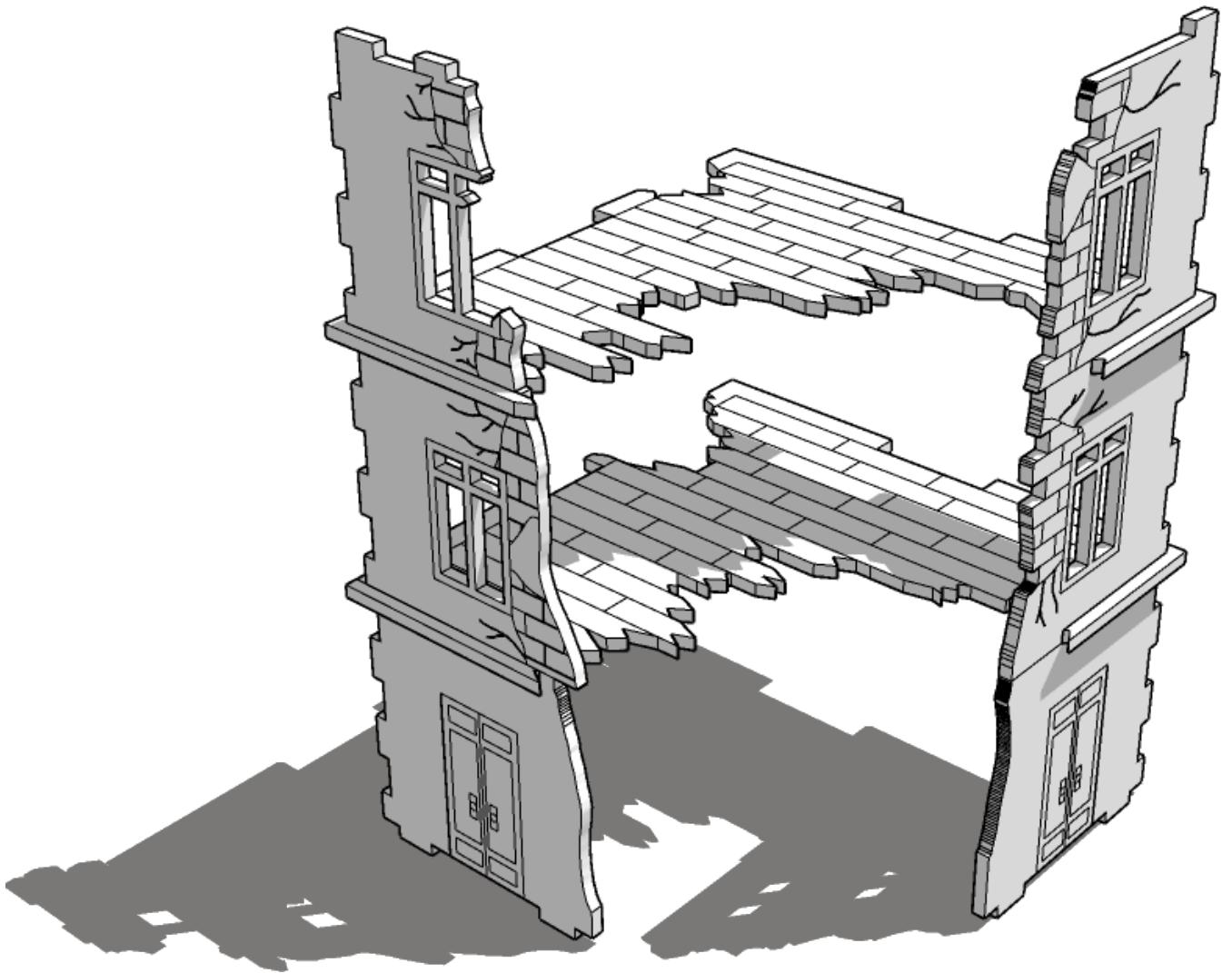



# TABLETOP SCENICS

**TTSC-WAR-O83**  
**City, Corner & Delapidated**  
**Rowhouse Destroyed**

**6**

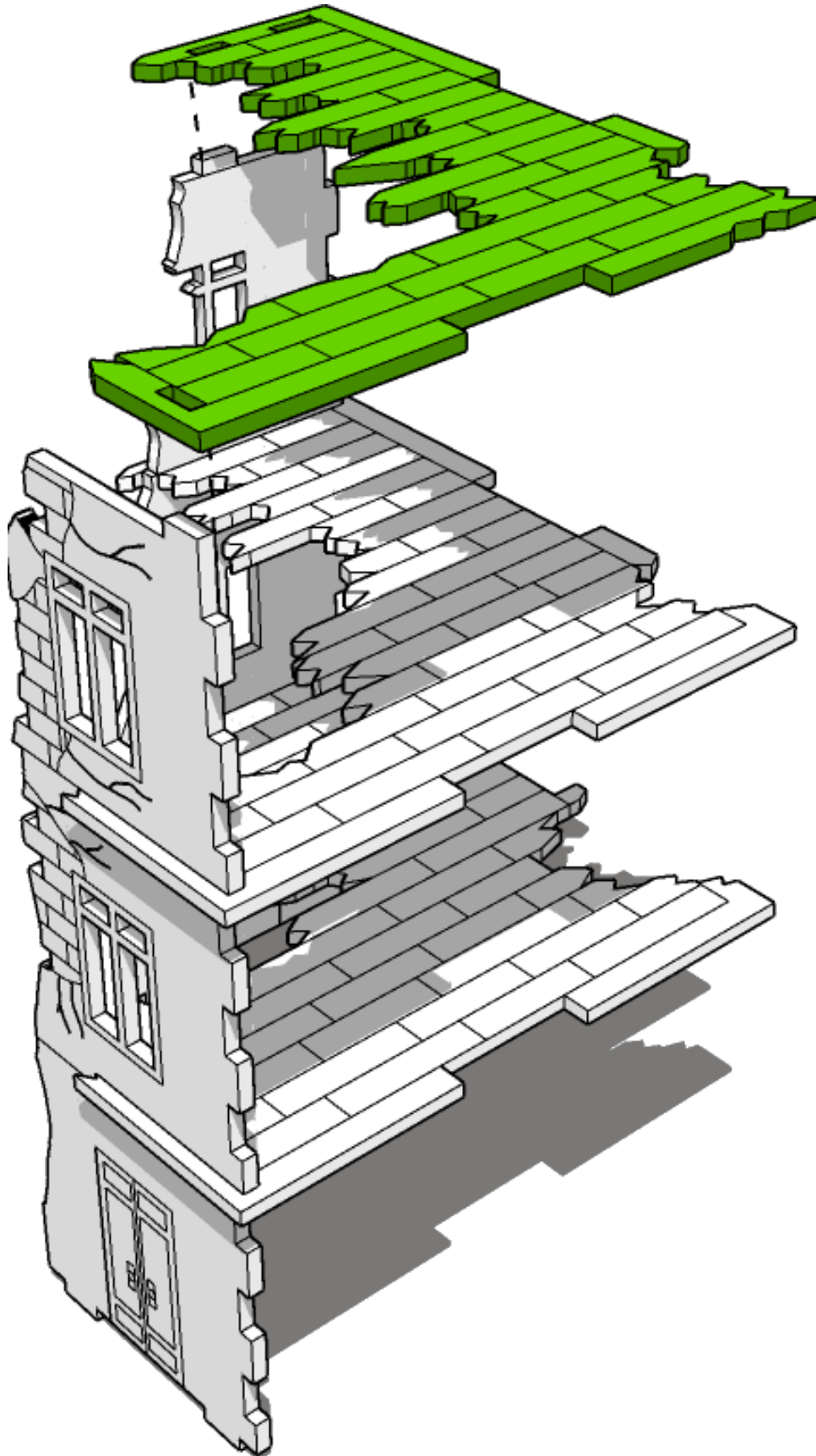



# TABLETOP SCENICS

TTSC-WAR-O83  
City, Corner & Delapidated  
Rowhouse Destroyed

7

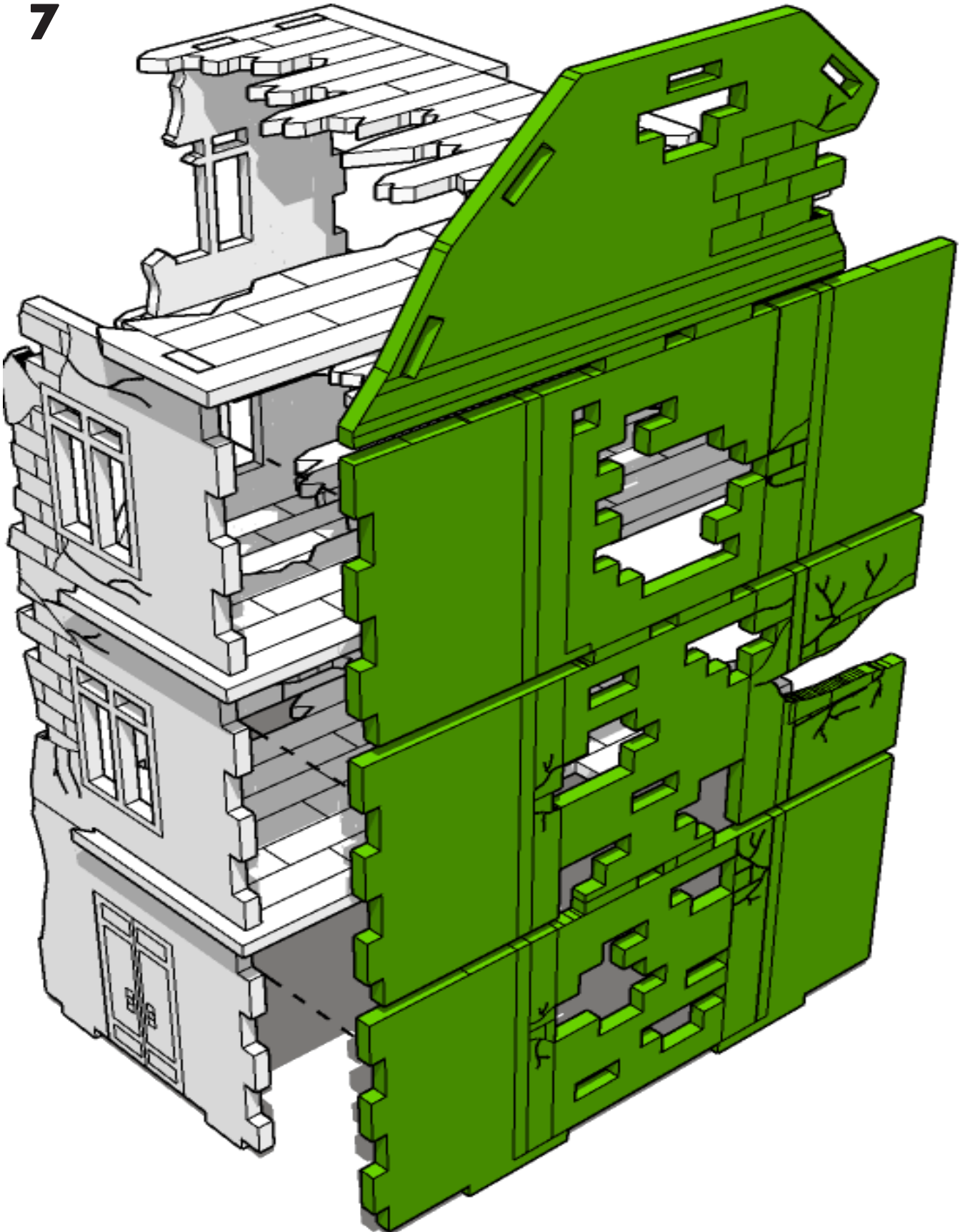





# TABLETOP SCENICS

TTSC-WAR-O83  
City, Corner & Delapidated  
Rowhouse Destroyed

8

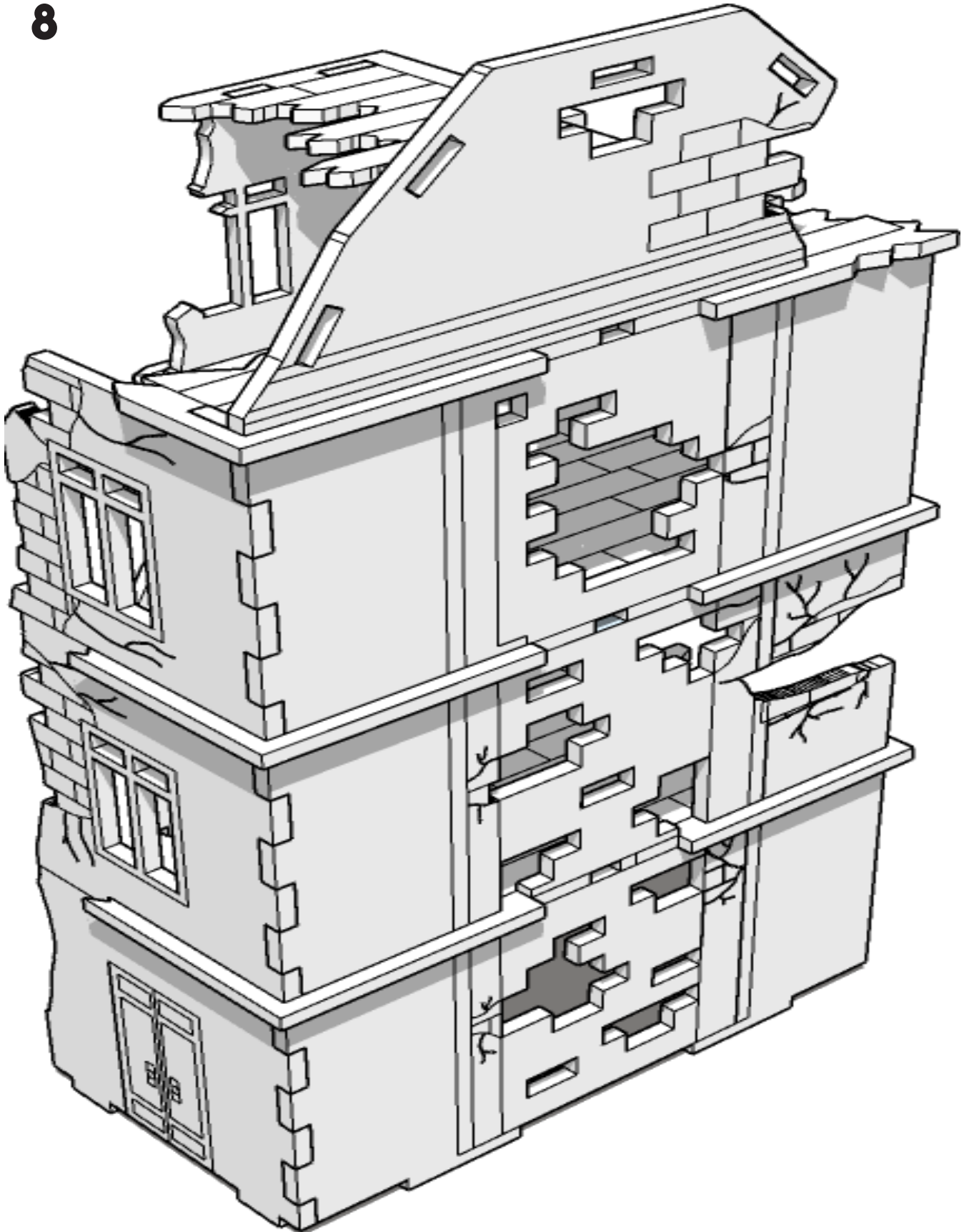



# TABLETOP SCENICS

**TTSC-WAR-O83**  
**City, Corner & Delapidated**  
**Rowhouse Destroyed**

**9**

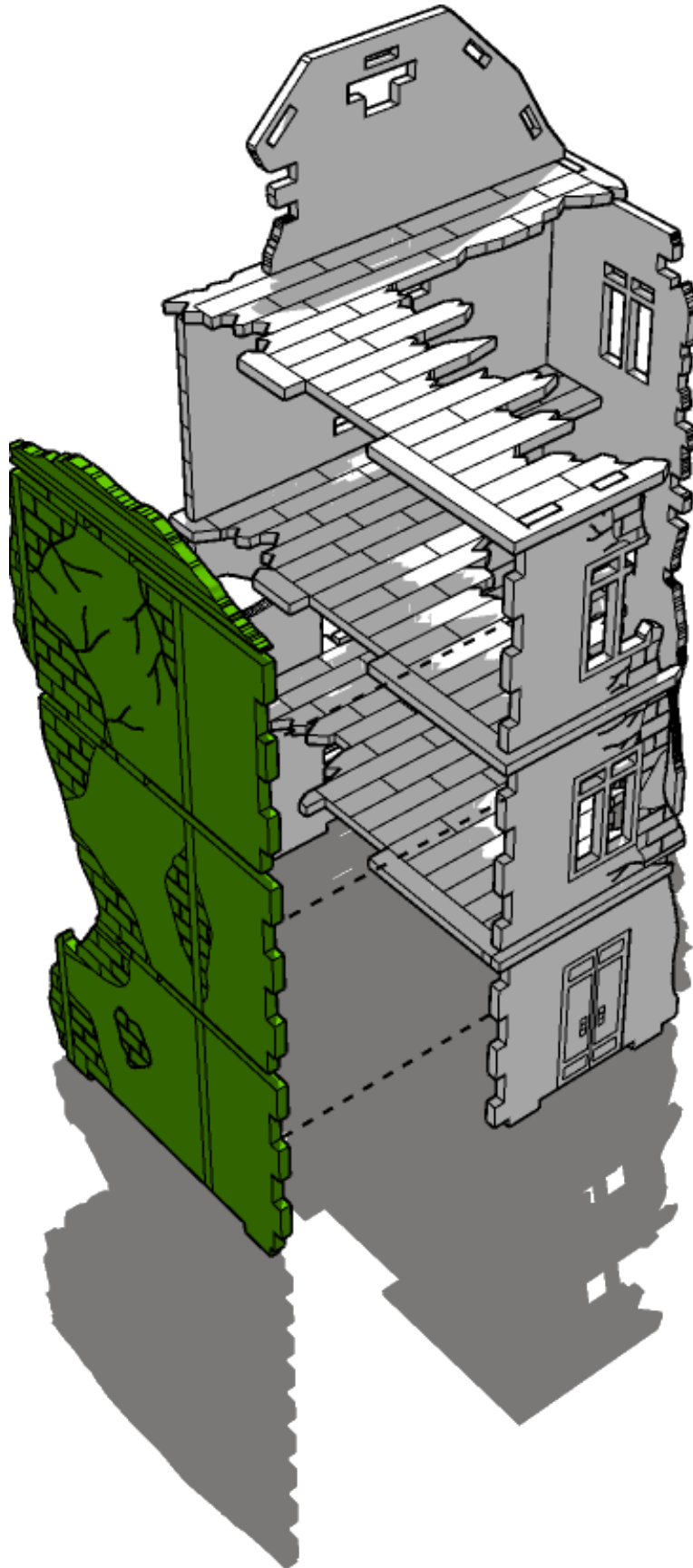



# TABLETOP SCENICS

**TTSC-WAR-O83**  
**City, Corner & Delapidated**  
**Rowhouse Destroyed**

**10**

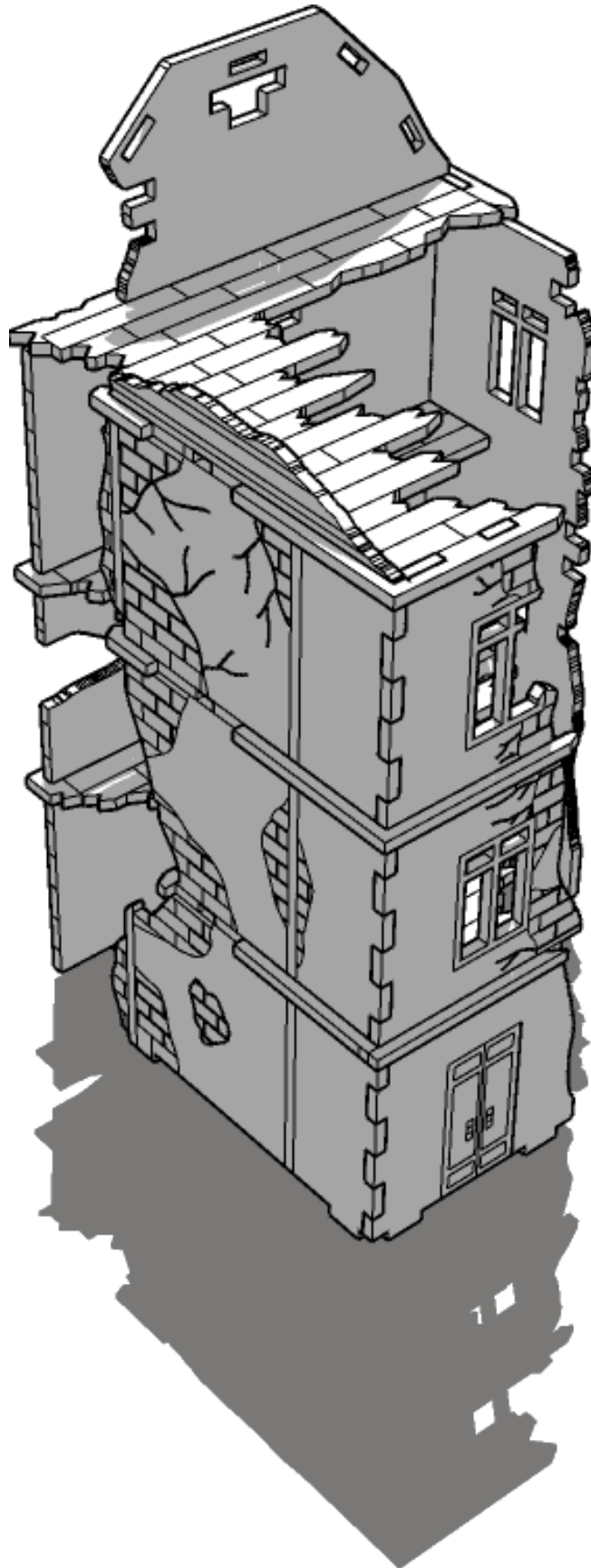



# TABLETOP SCENICS

**TTSC-WAR-O83**  
**City, Corner & Delapidated**  
**Rowhouse Destroyed**

**11**

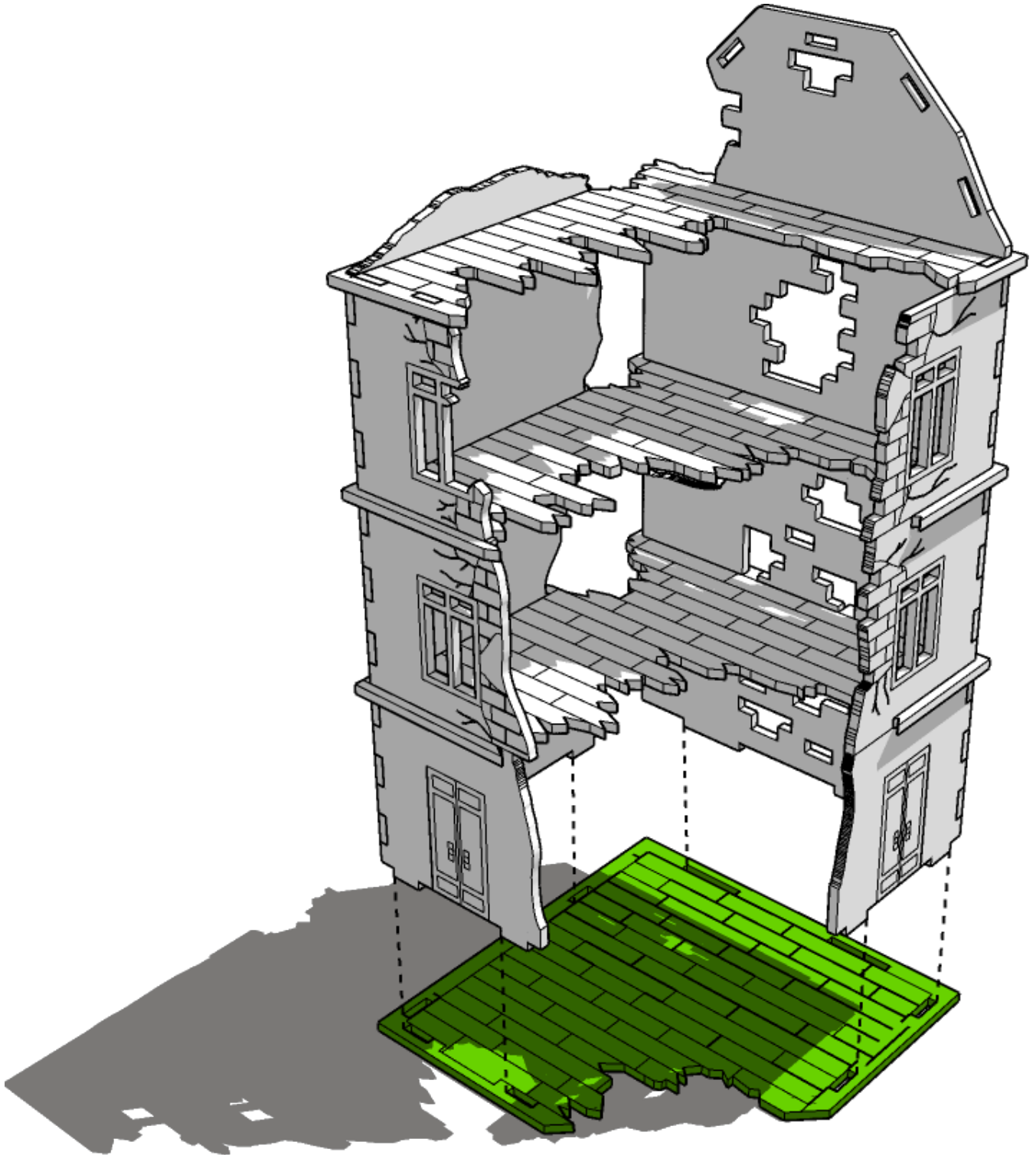



# TABLETOP SCENICS

12

**TTSC-WAR-O83**  
**City, Corner & Delapidated**  
**Rowhouse Destroyed**

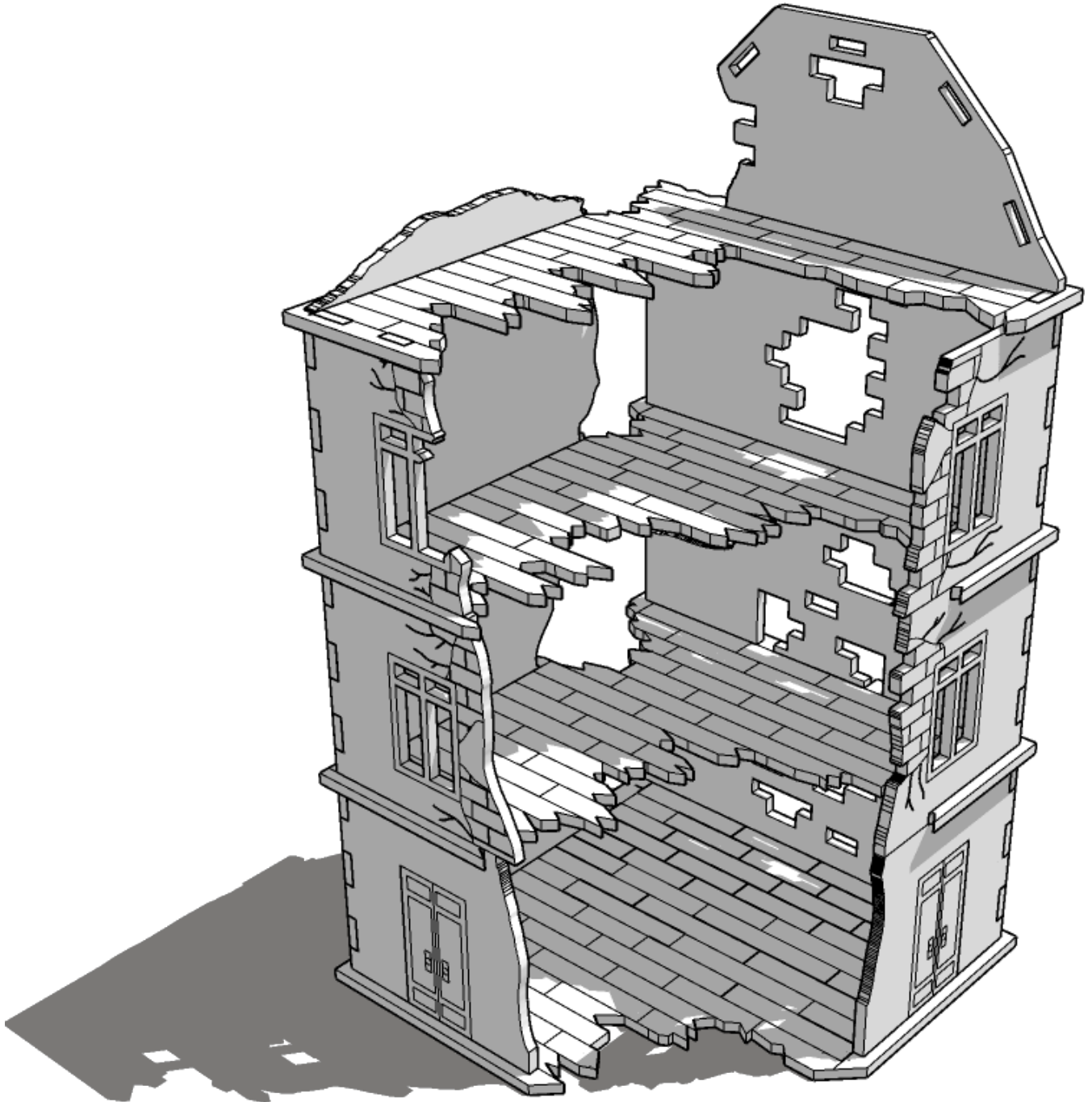



# TABLETOP SCENICS

**TTSC-WAR-O83**  
**City, Corner & Delapidated**  
**Rowhouse Destroyed**

**13**

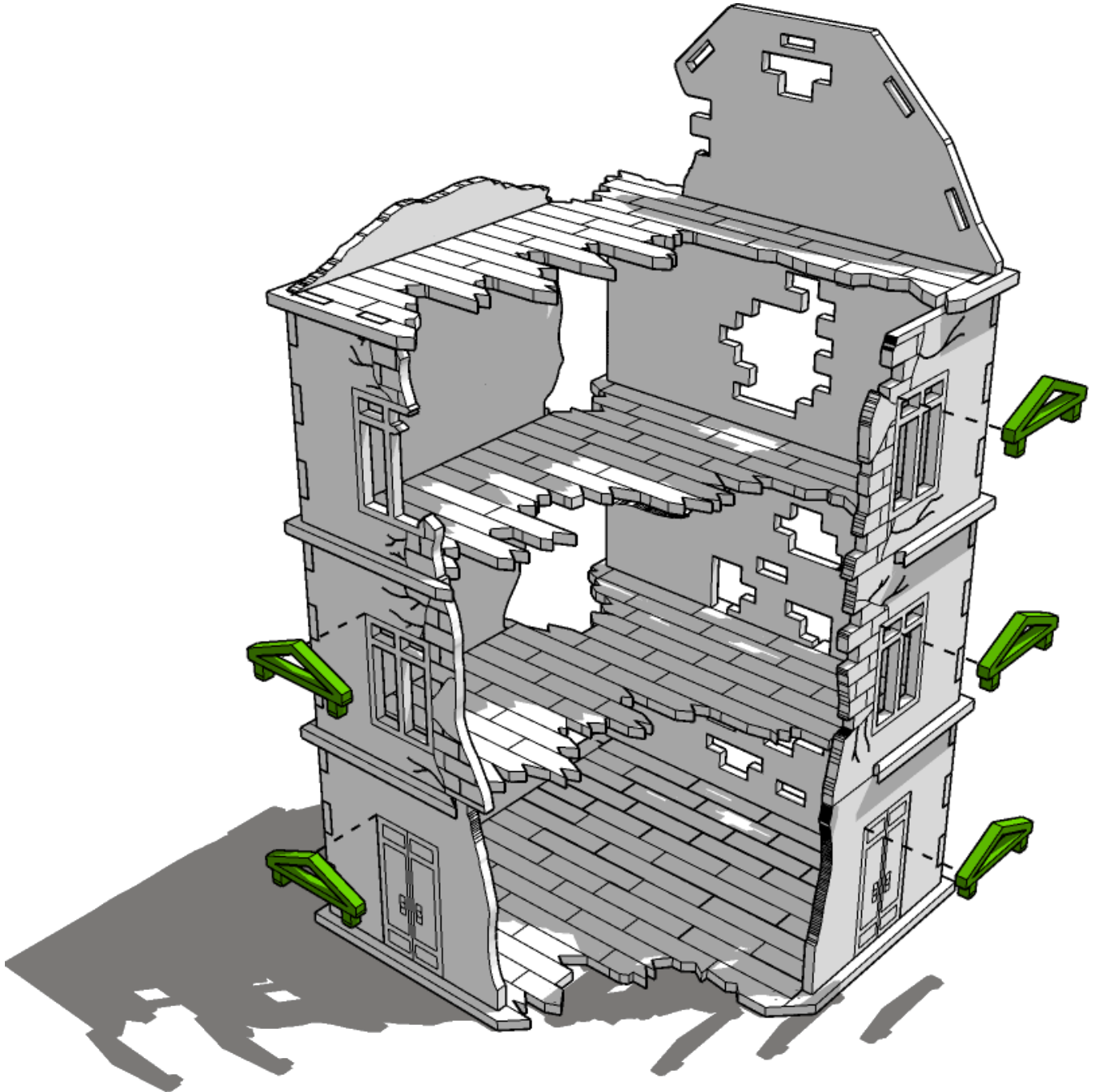



# TABLETOP SCENICS

**TTSC-WAR-O83**  
**City, Corner & Delapidated**  
**Rowhouse Destroyed**

**14**

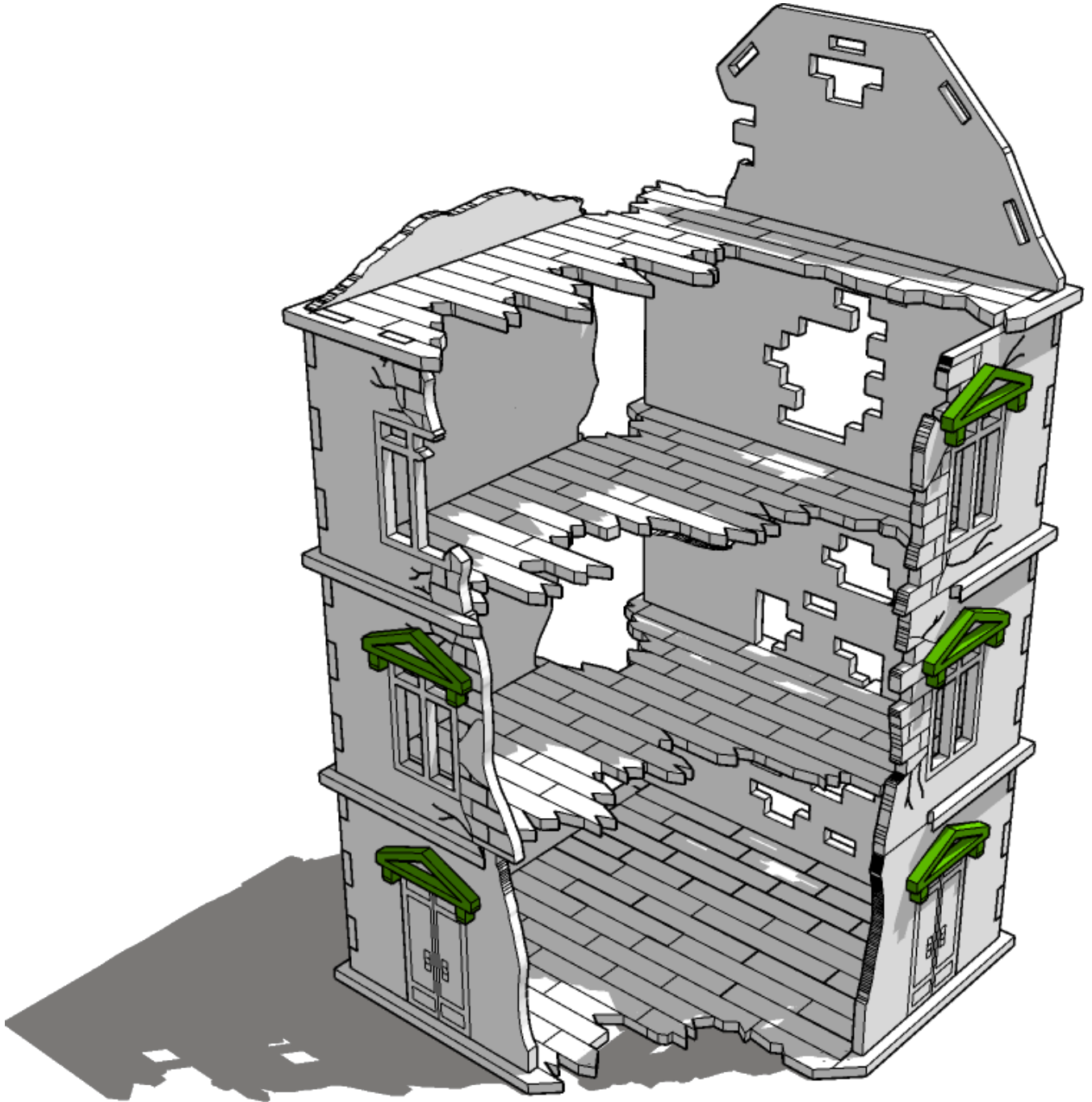



# TABLETOP SCENICS

**TTSC-WAR-O83**  
**City, Corner & Delapidated**  
**Rowhouse Destroyed**

**15**

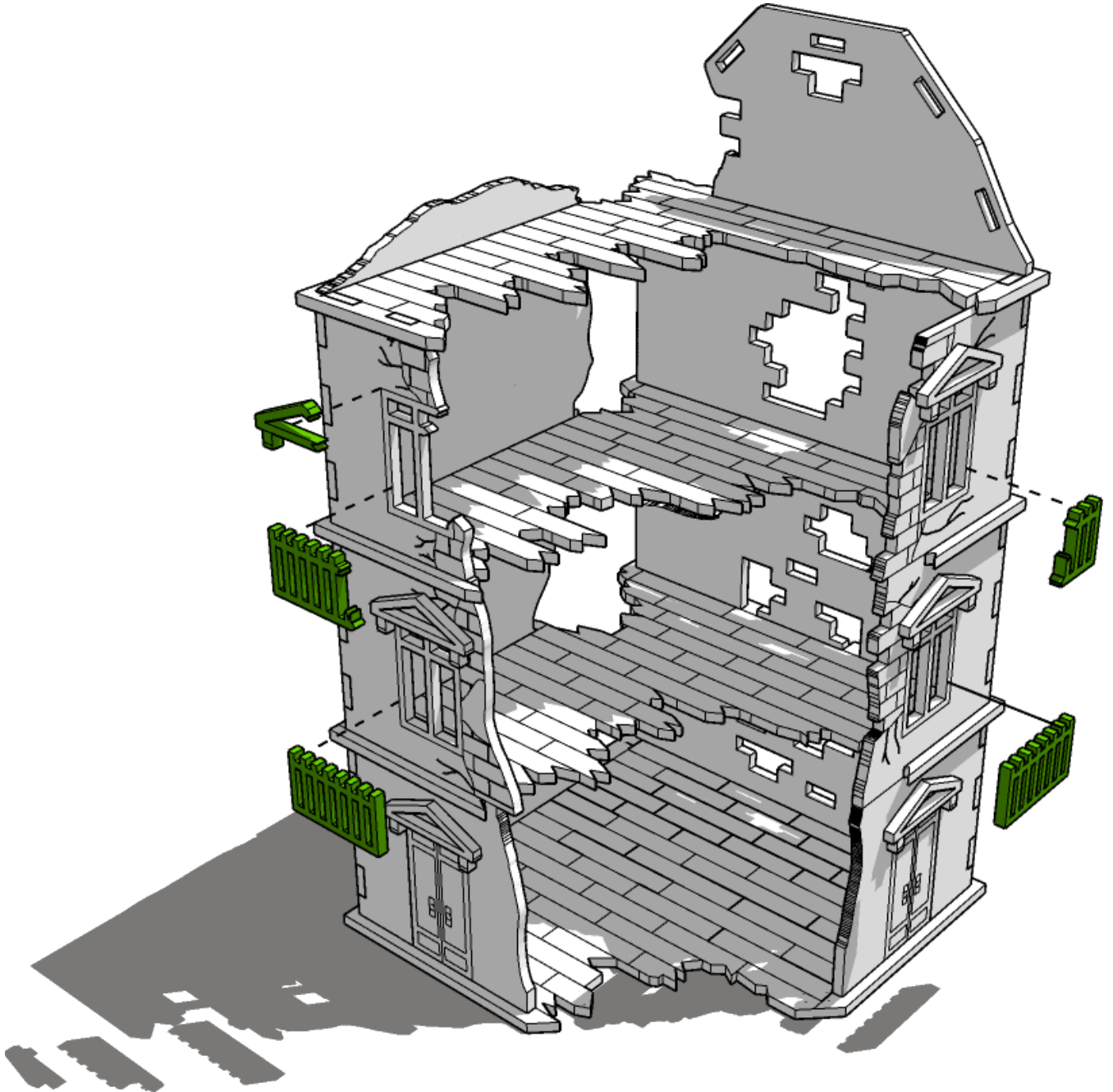





# TABLETOP SCENICS

16

TTSC-WAR-O83  
City, Corner & Delapidated  
Rowhouse Destroyed

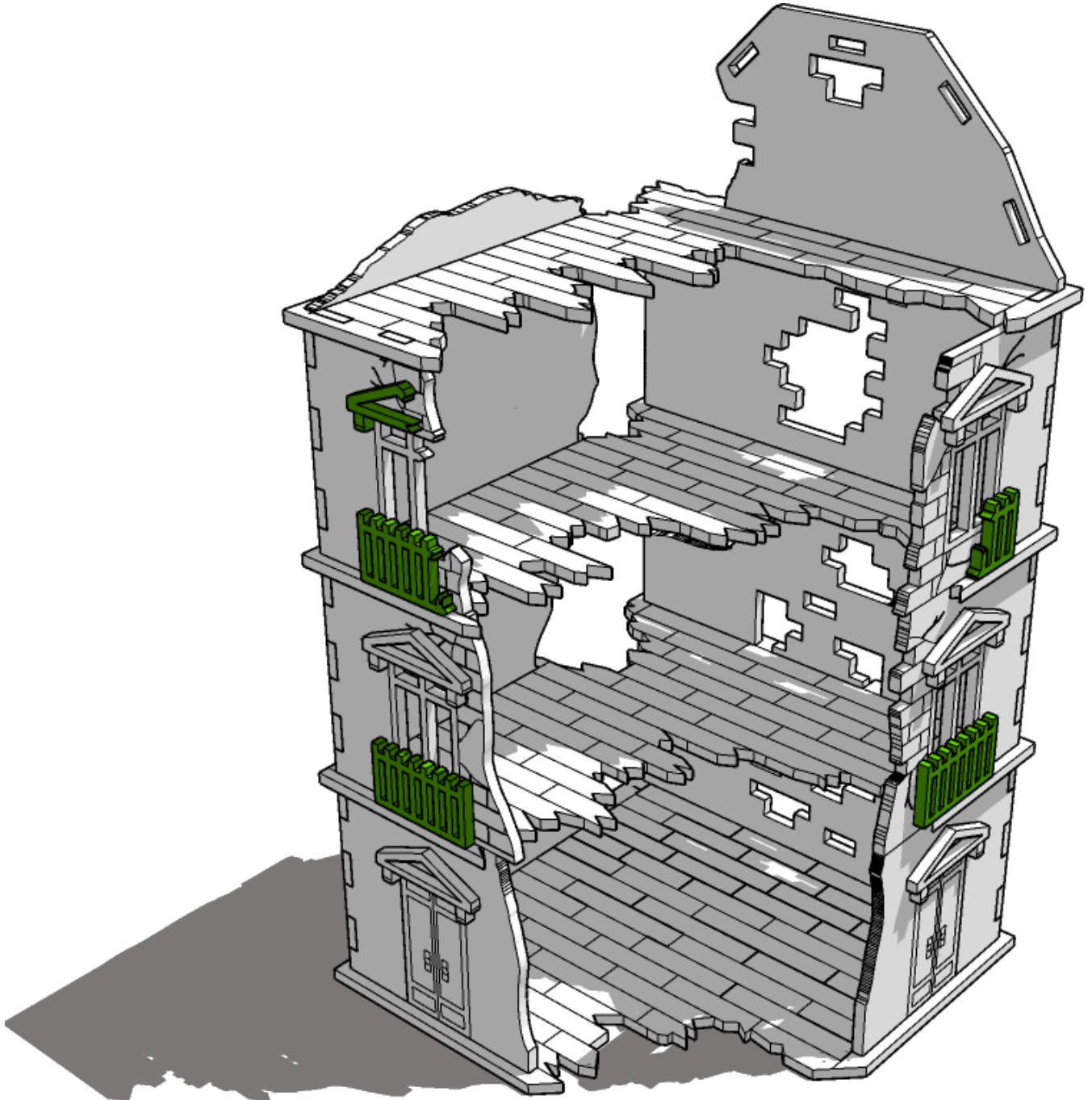



# TABLETOP SCENICS

**TTSC-WAR-O83**  
**City, Corner & Delapidated**  
**Rowhouse Destroyed**

**17**

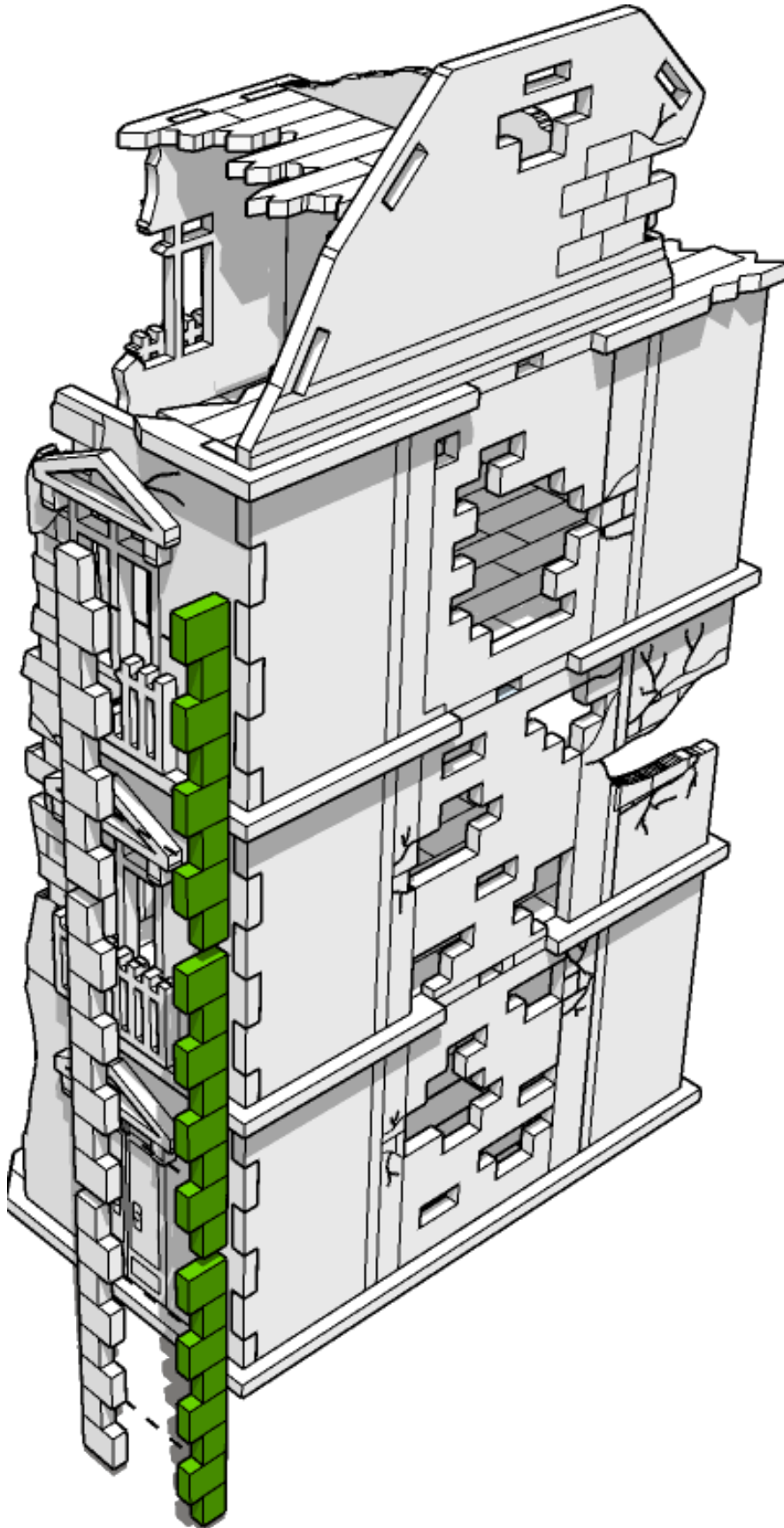



# TABLETOP SCENICS

**TTSC-WAR-O83**  
**City, Corner & Delapidated**  
**Rowhouse Destroyed**

**18**

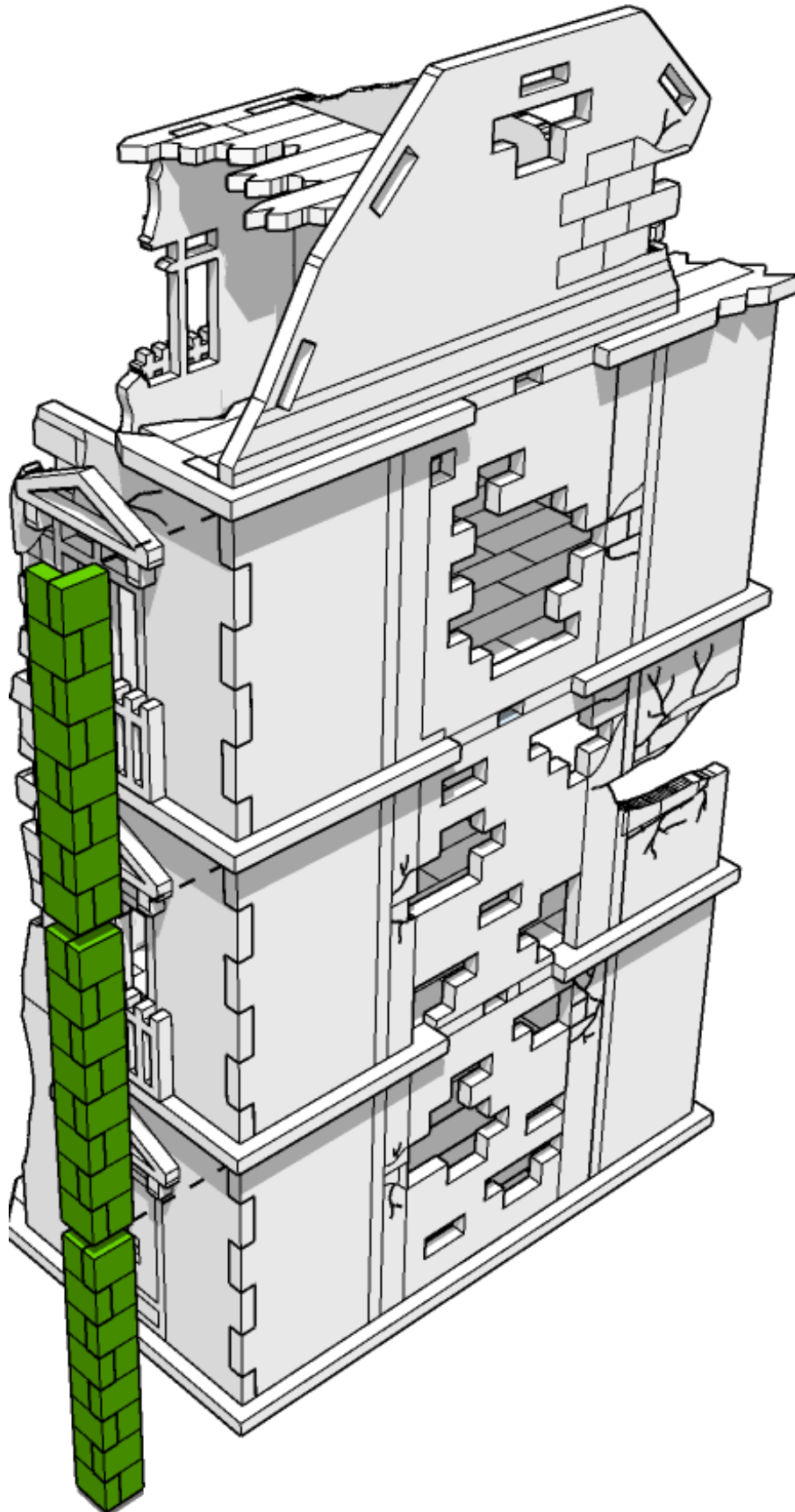



# TABLETOP SCENICS

TTSC-WAR-O83  
City, Corner & Delapidated  
Rowhouse Destroyed

19

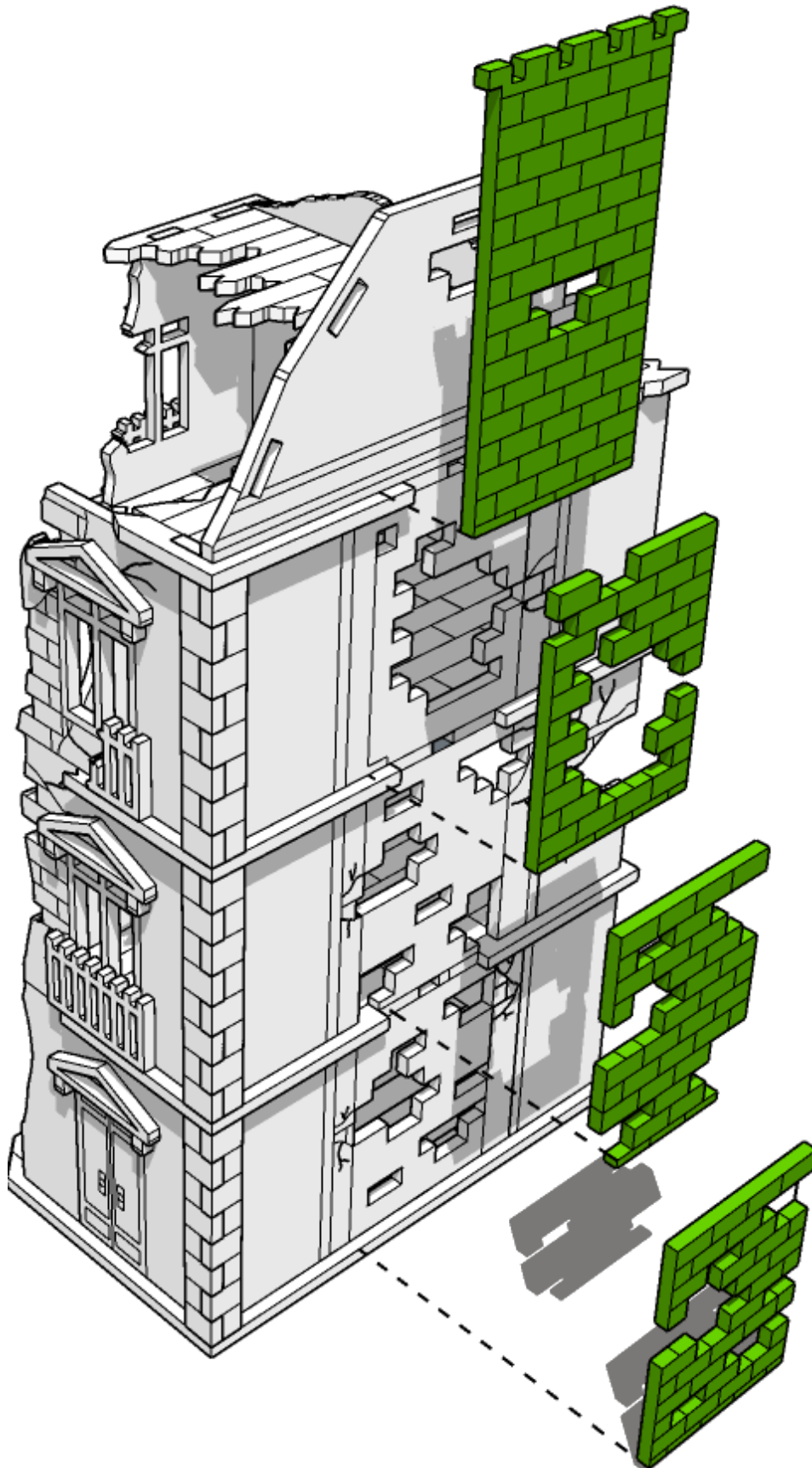



# TABLETOP SCENICS

20

TTSC-WAR-O83  
City, Corner & Delapidated  
Rowhouse Destroyed

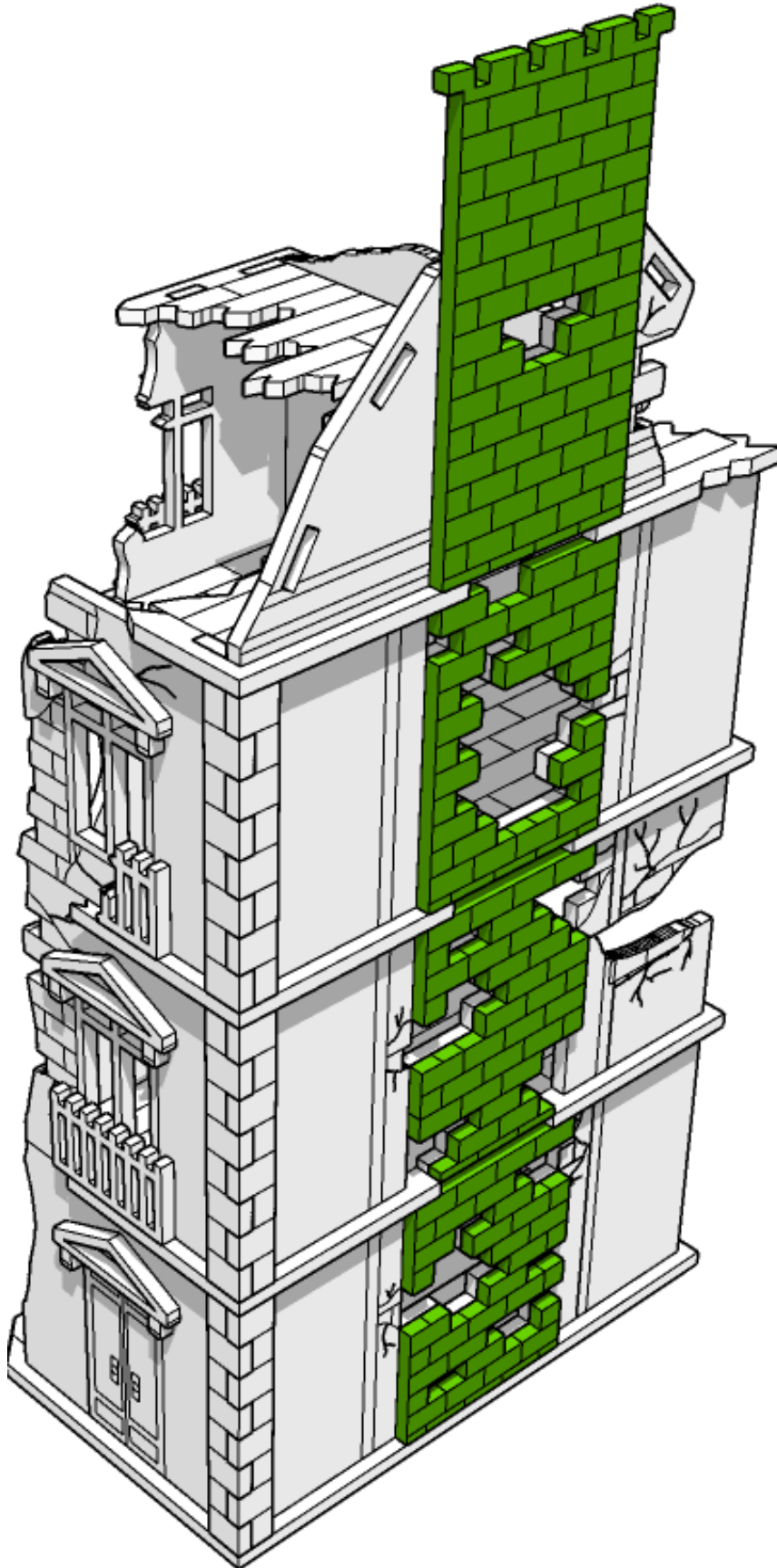



# TABLETOP SCENICS

**TTSC-WAR-O83**  
**City, Corner & Delapidated**  
**Rowhouse Destroyed**

**21**

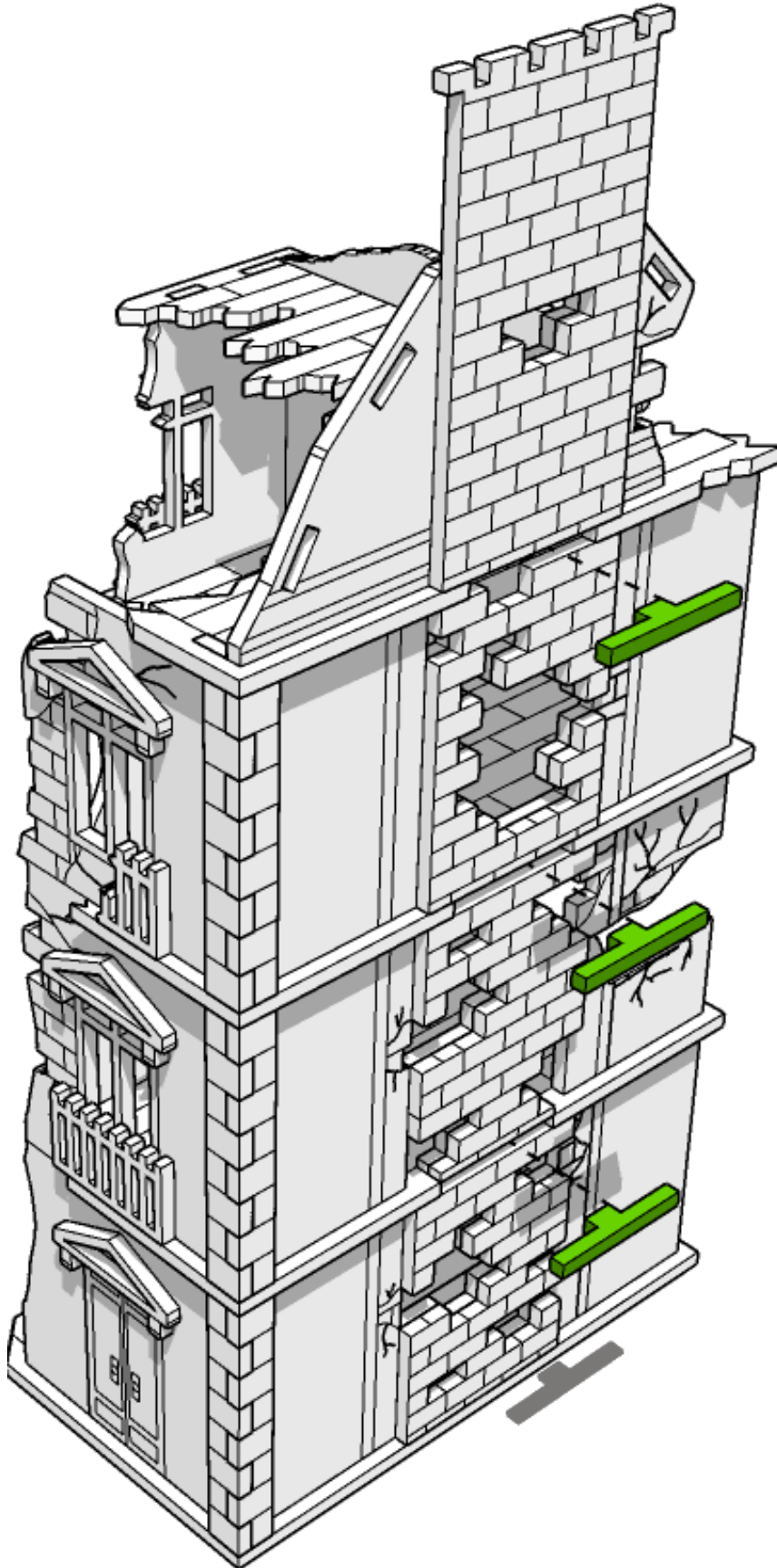



# TABLETOP SCENICS

**TTSC-WAR-O83**  
**City, Corner & Delapidated**  
**Rowhouse Destroyed**

**22**

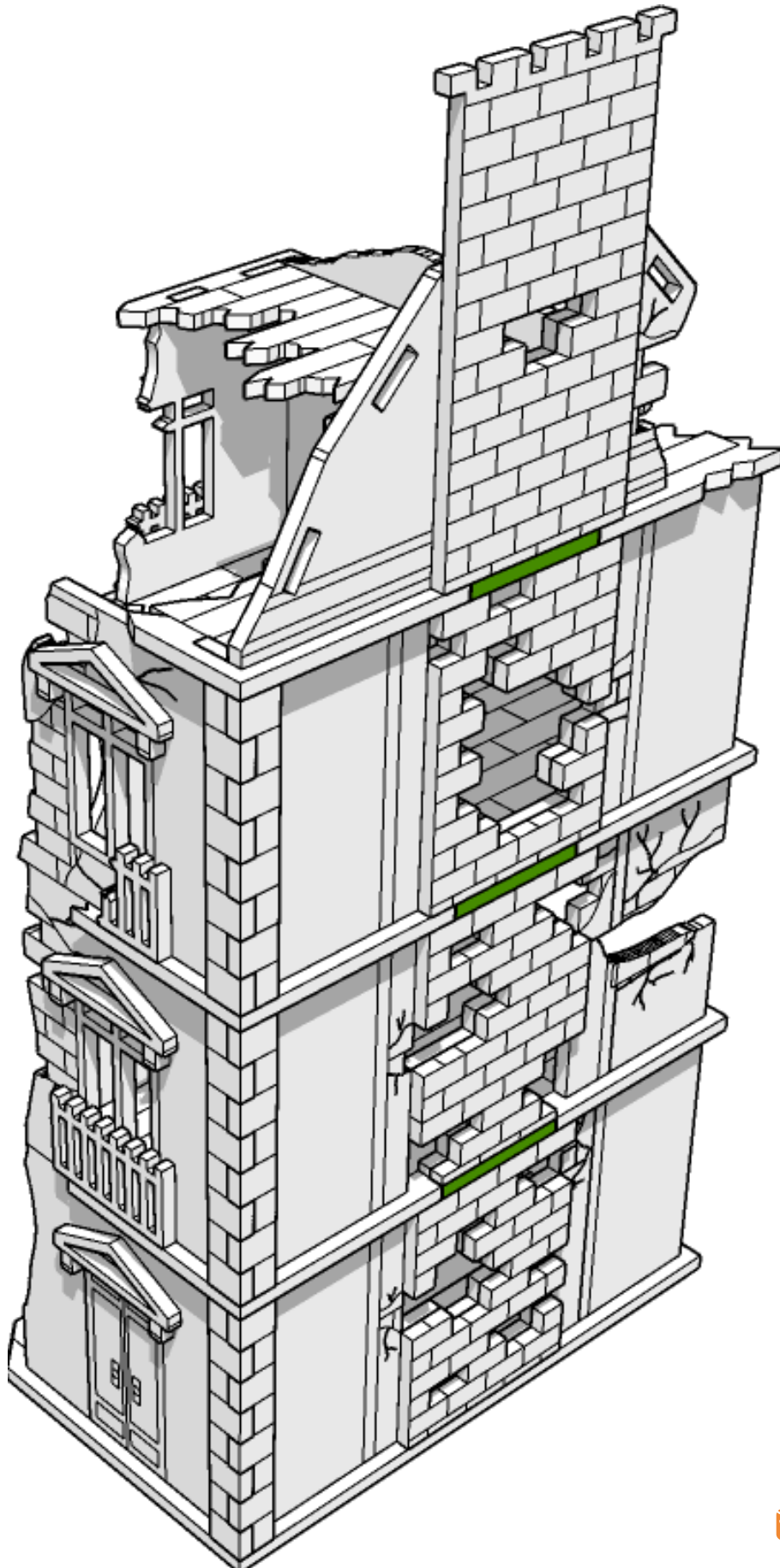



# TABLETOP SCENICS

**TTSC-WAR-O83**  
**City, Corner & Delapidated**  
**Rowhouse Destroyed**

**23**

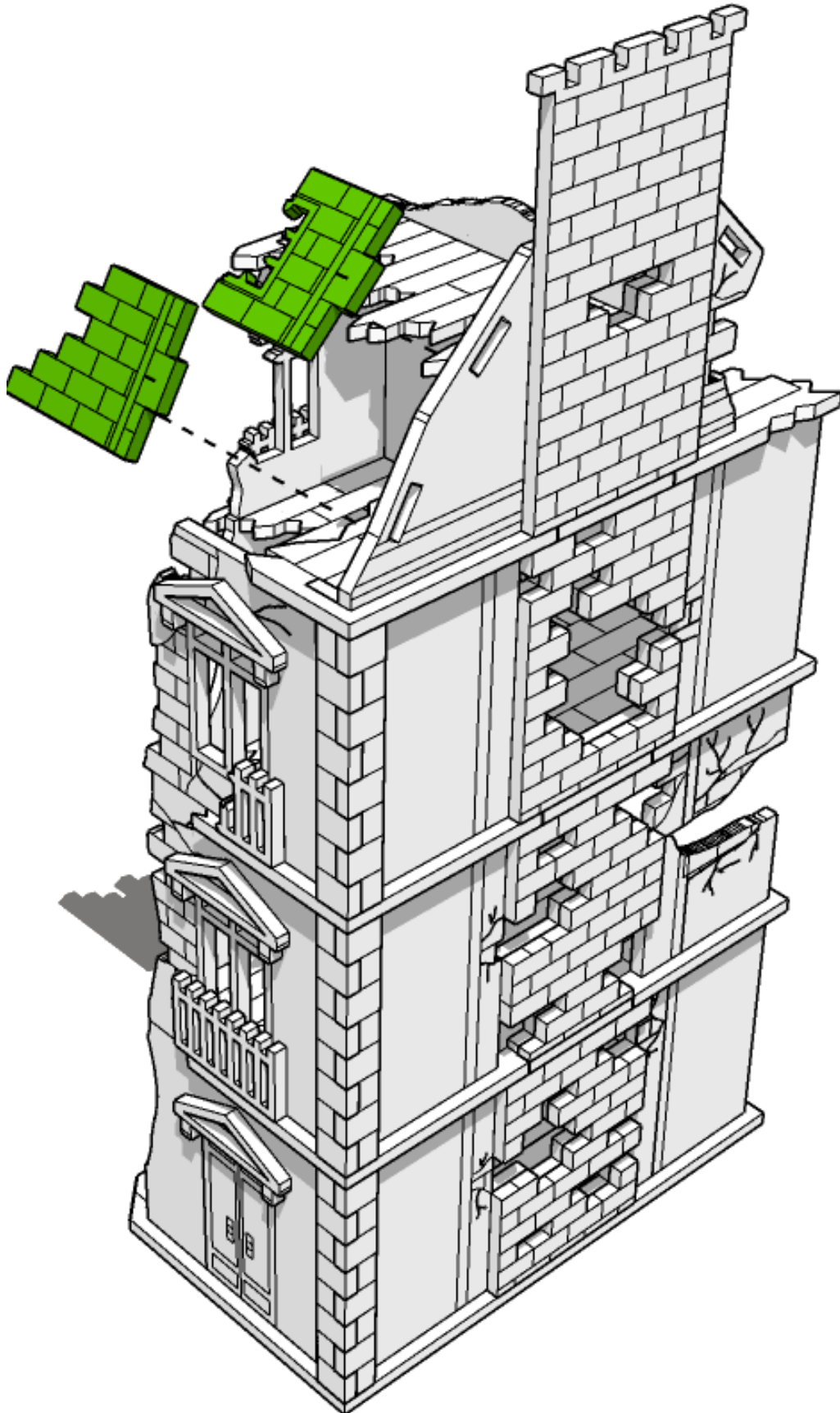





# TABLETOP SCENICS

**TTSC-WAR-O83**  
**City, Corner & Delapidated**  
**Rowhouse Destroyed**

**24**

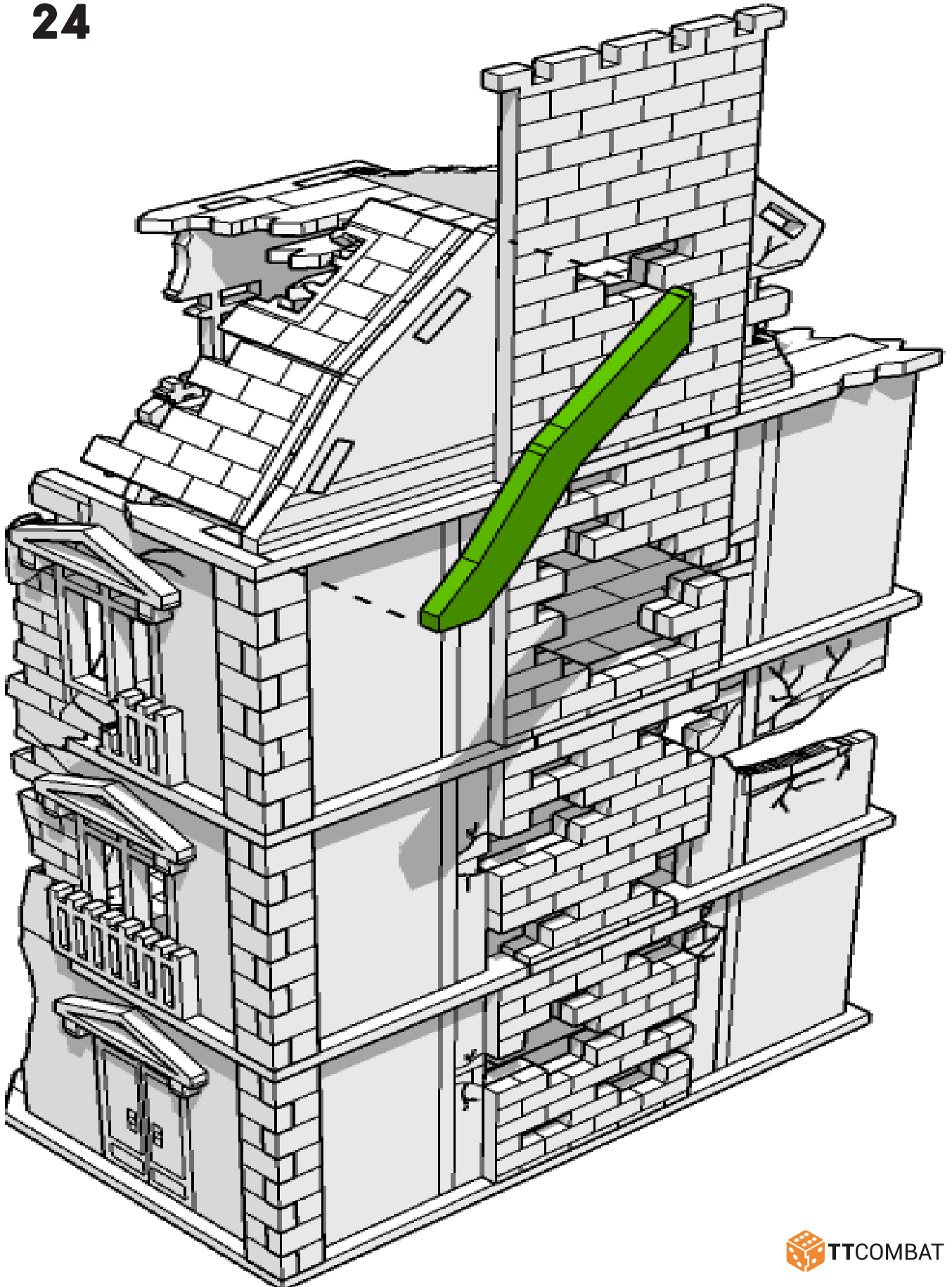



# TABLETOP SCENICS

**TTSC-WAR-O83**  
**City, Corner & Delapidated**  
**Rowhouse Destroyed**

**25**

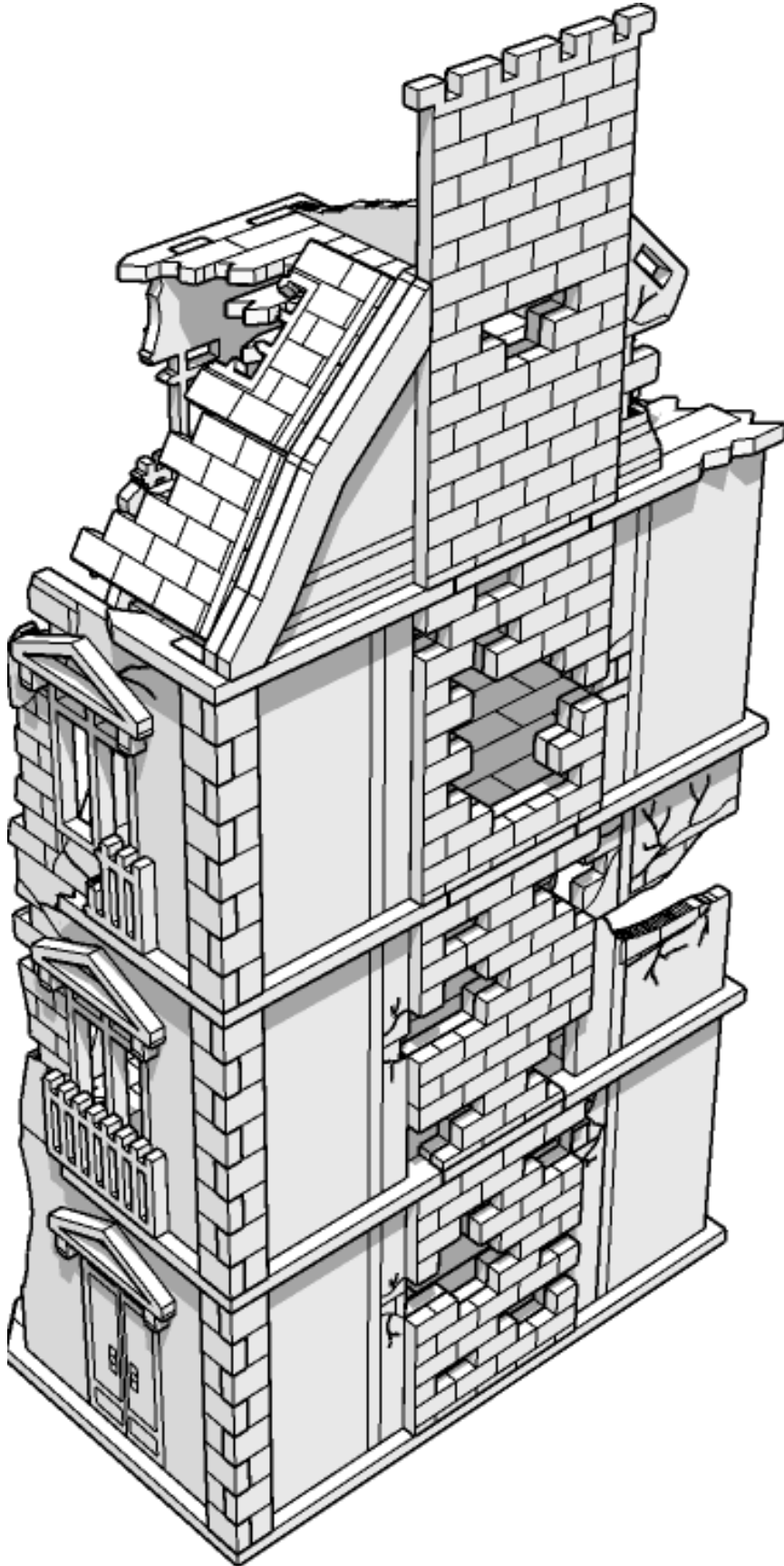



# TABLETOP SCENICS

TTSC-WAR-O83  
City, Corner & Delapidated  
Rowhouse Destroyed

26

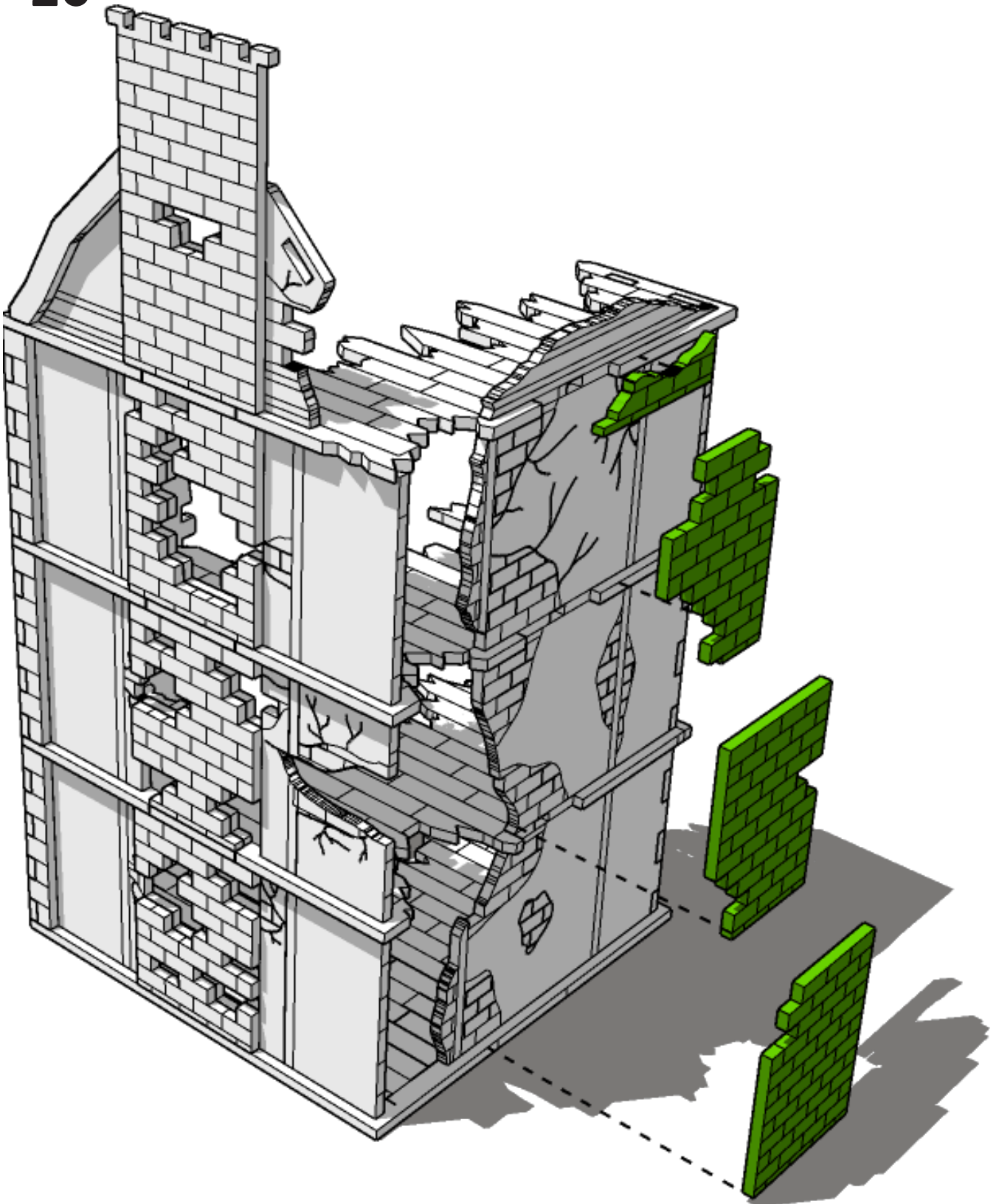



# TABLETOP SCENICS

**TTSC-WAR-O83**  
**City, Corner & Delapidated**  
**Rowhouse Destroyed**

**27**

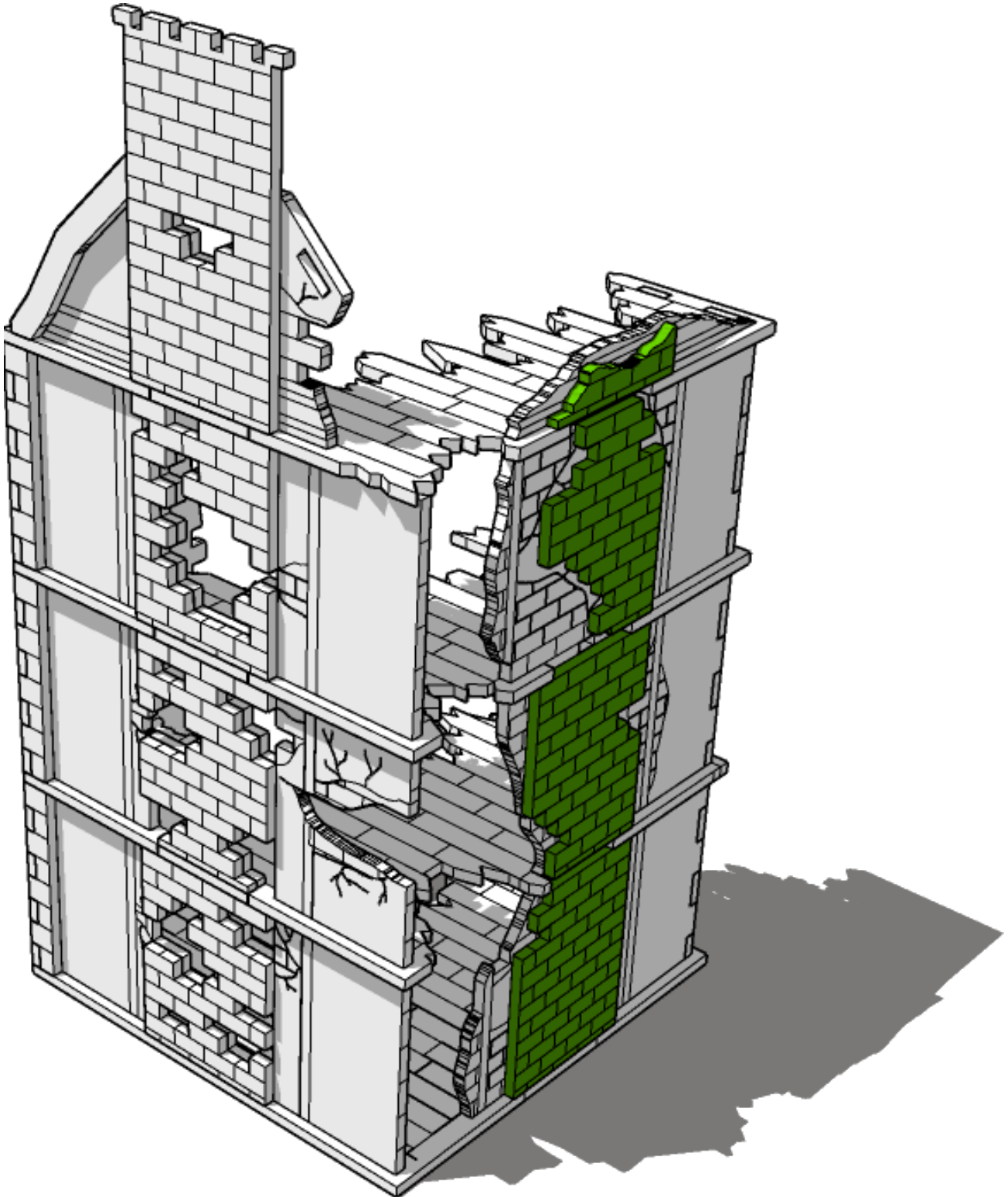



# TABLETOP SCENICS

**TTSC-WAR-O83**  
**City, Corner & Delapidated**  
**Rowhouse Destroyed**

**28**

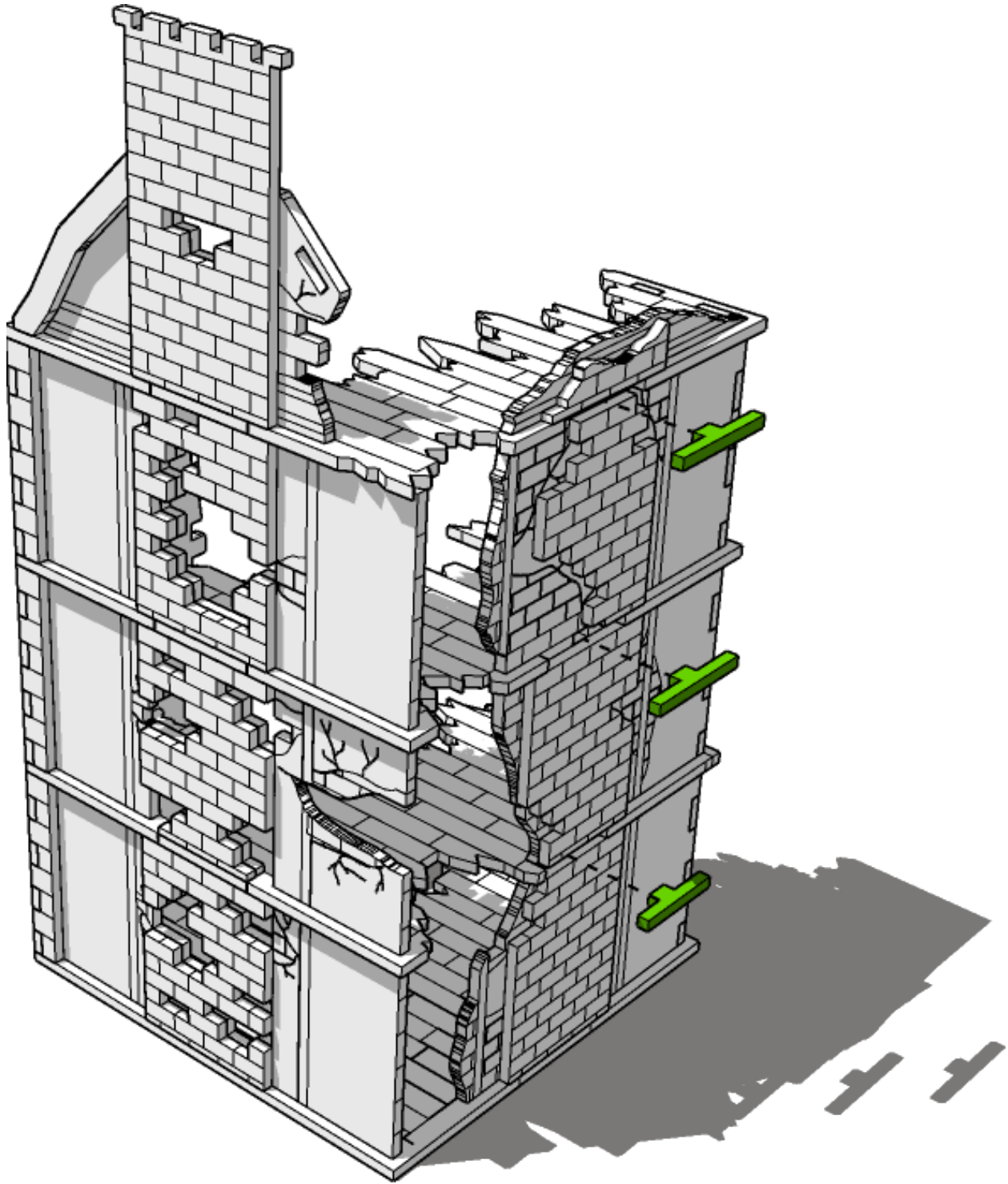



# TABLETOP SCENICS

TTSC-WAR-O83  
City, Corner & Delapidated  
Rowhouse Destroyed

29

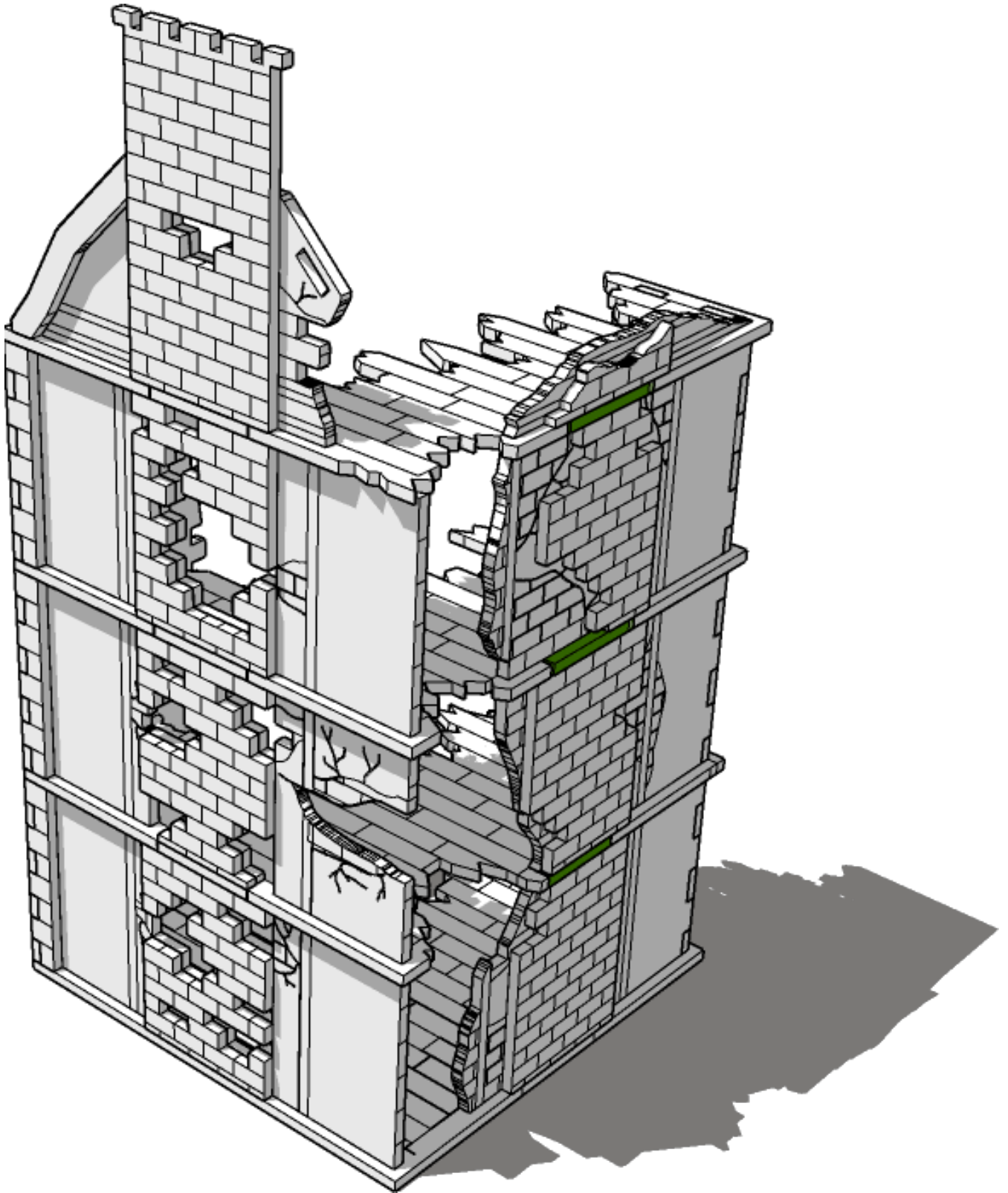



# TABLETOP SCENICS

TTSC-WAR-O83  
City, Corner & Delapidated  
Rowhouse Destroyed

30

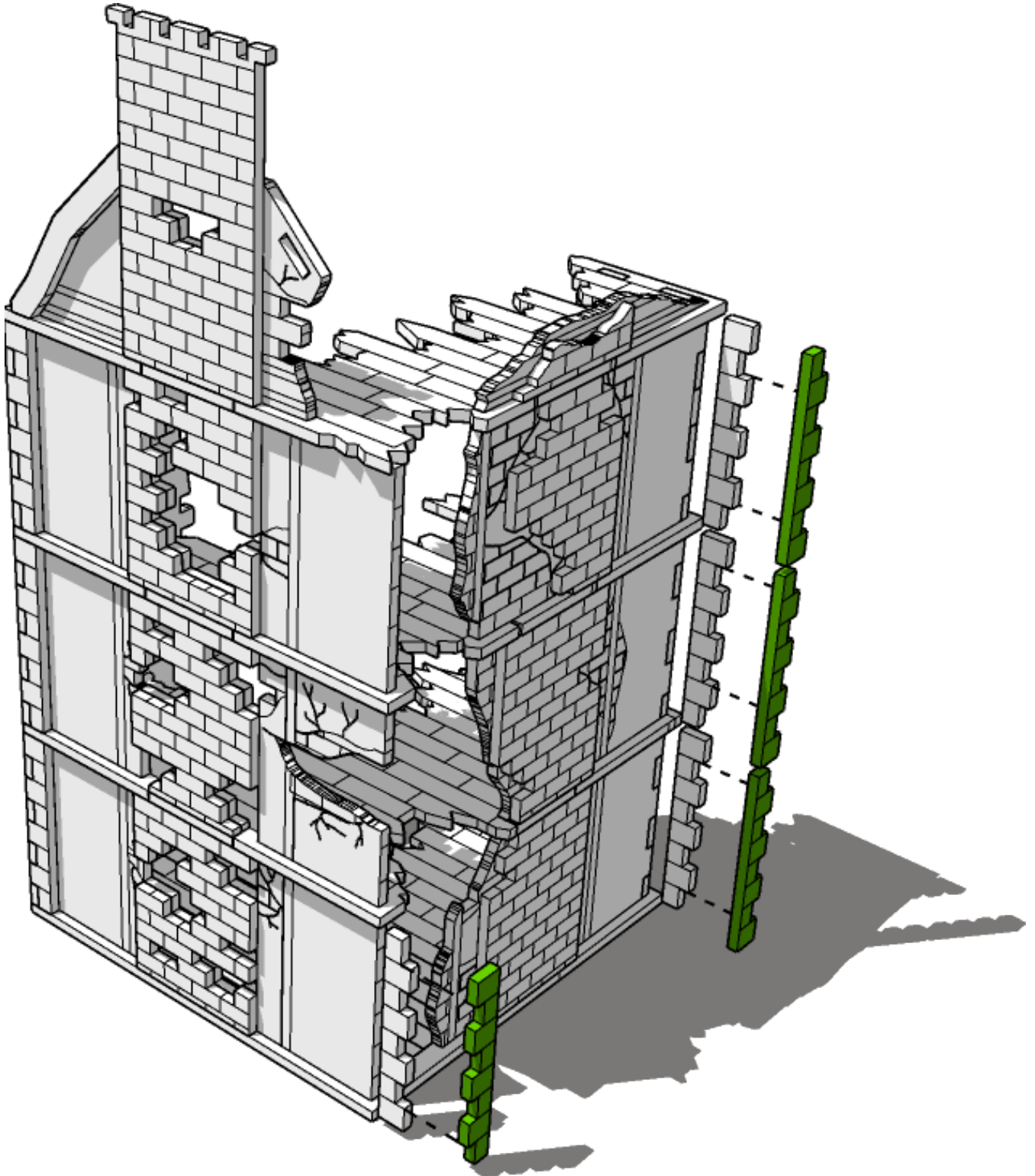



# TABLETOP SCENICS

TTSC-WAR-O83  
City, Corner & Delapidated  
Rowhouse Destroyed

31

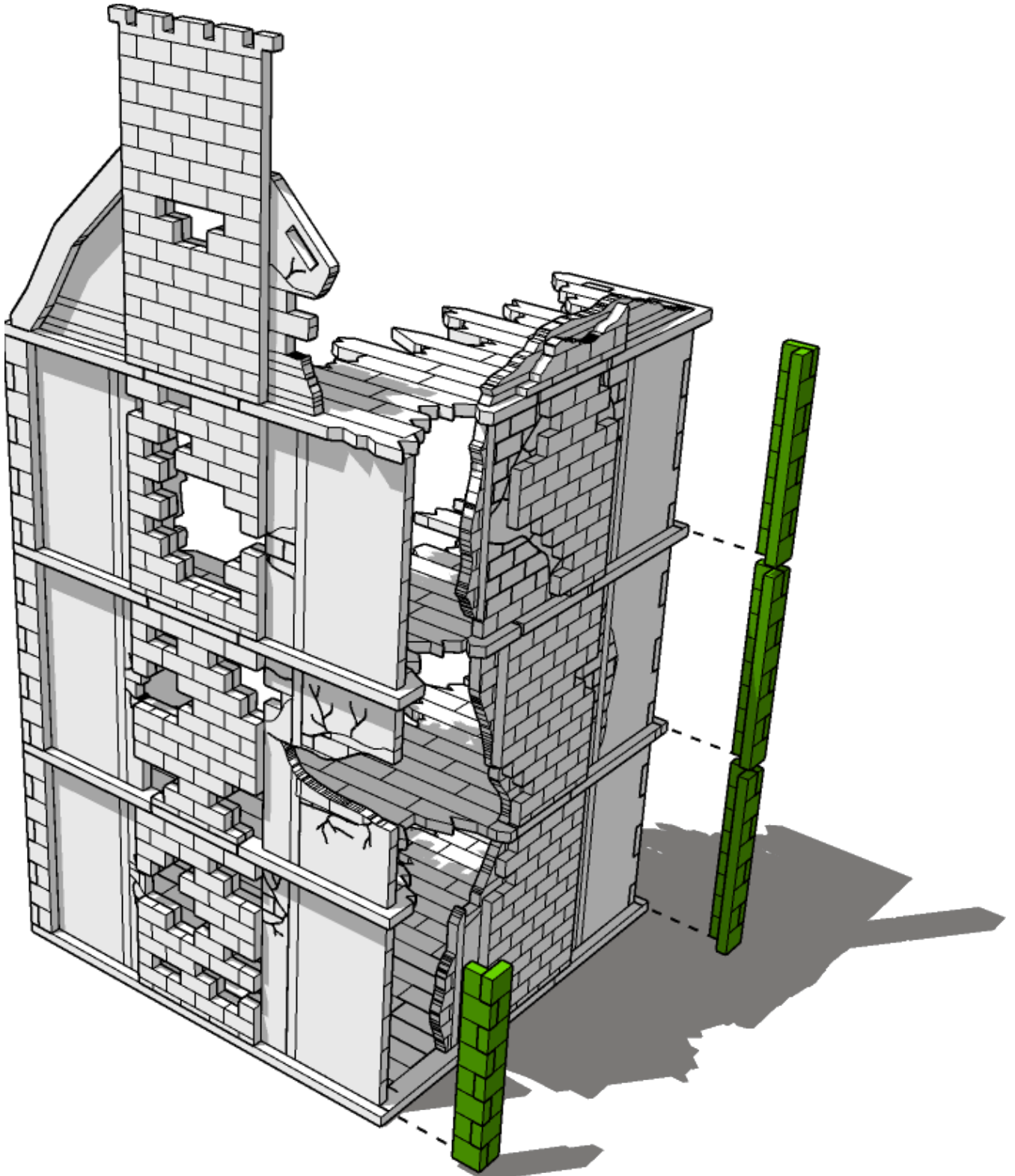





# TABLETOP SCENICS

TTSC-WAR-O83  
City, Corner & Delapidated  
Rowhouse Destroyed

32

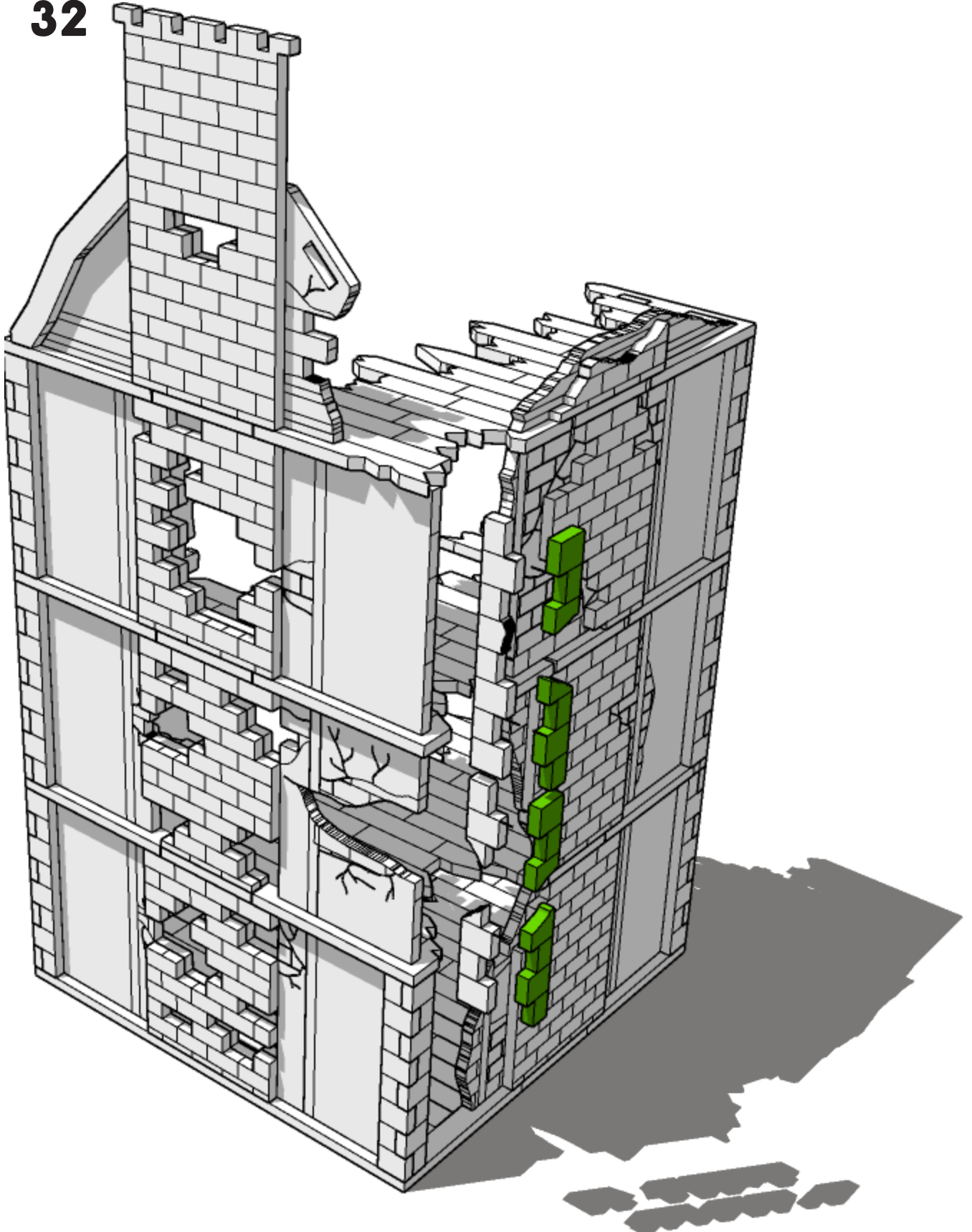



# TABLETOP SCENICS

TTSC-WAR-083  
City, Corner & Delapidated  
Rowhouse Destroyed

33

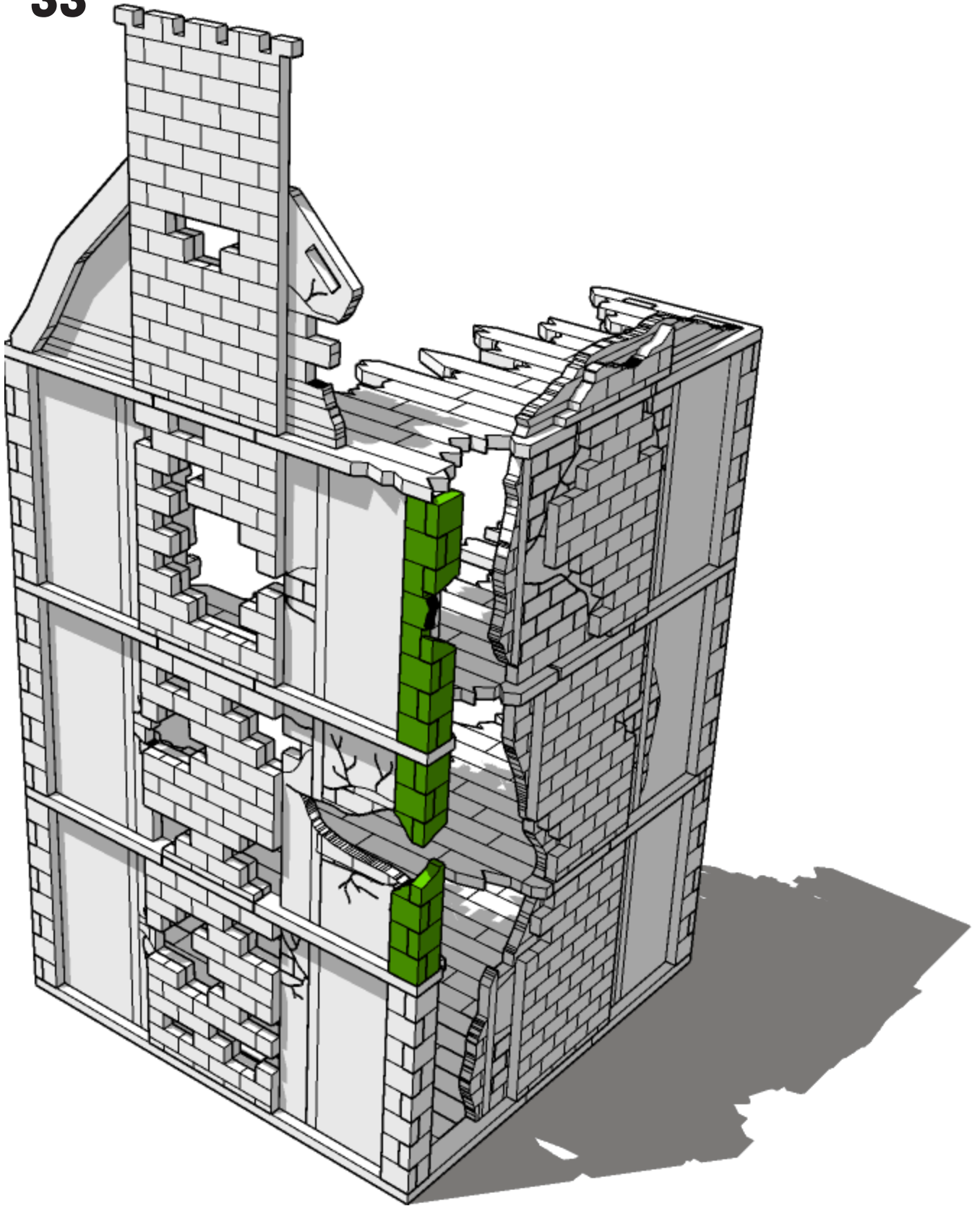



# TABLETOP SCENICS

**TTSC-WAR-O83**  
**City, Corner & Delapidated**  
**Rowhouse Destroyed**

**34**

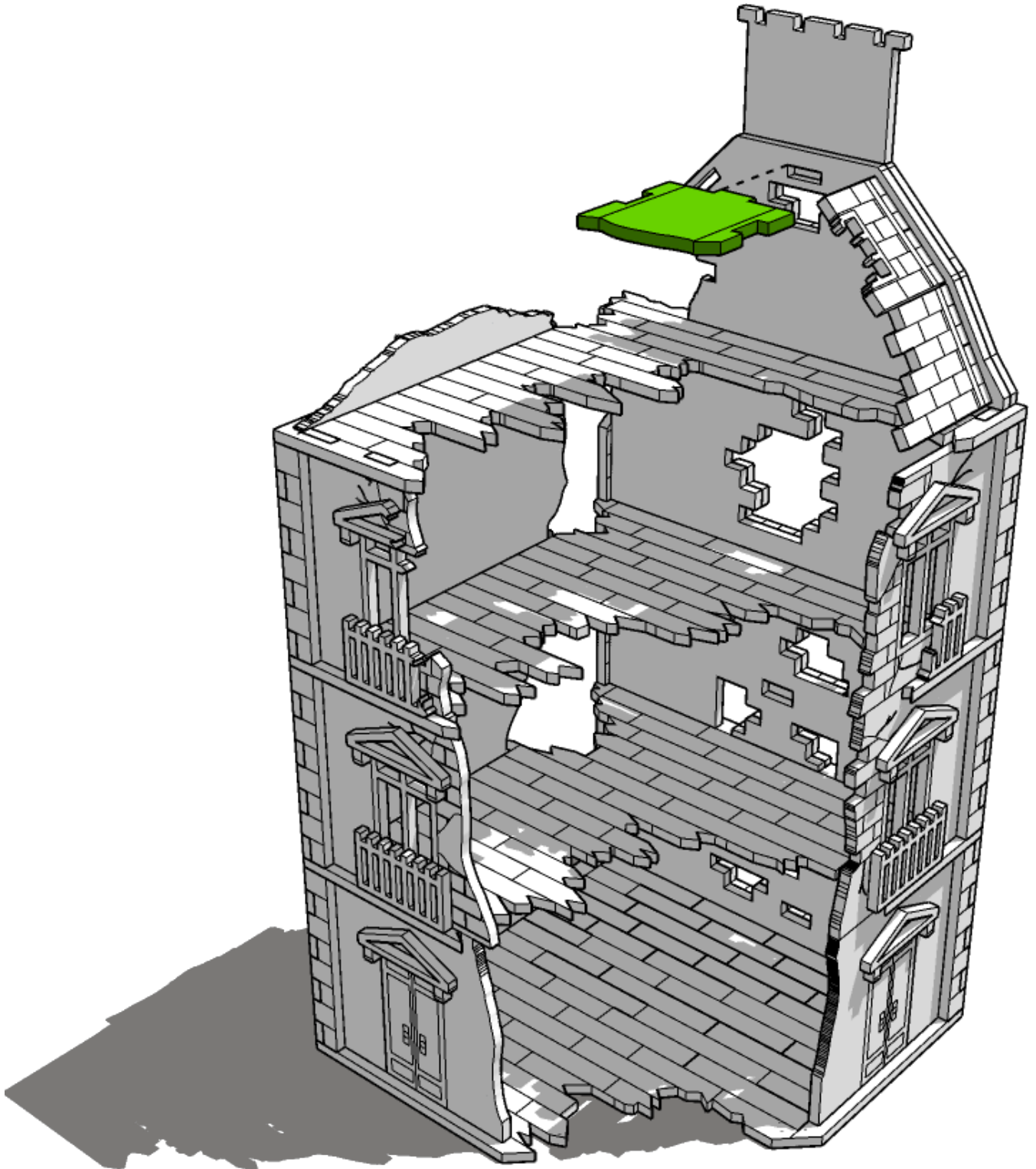



# TABLETOP SCENICS

35

TTSC-WAR-O83  
City, Corner & Delapidated  
Rowhouse Destroyed

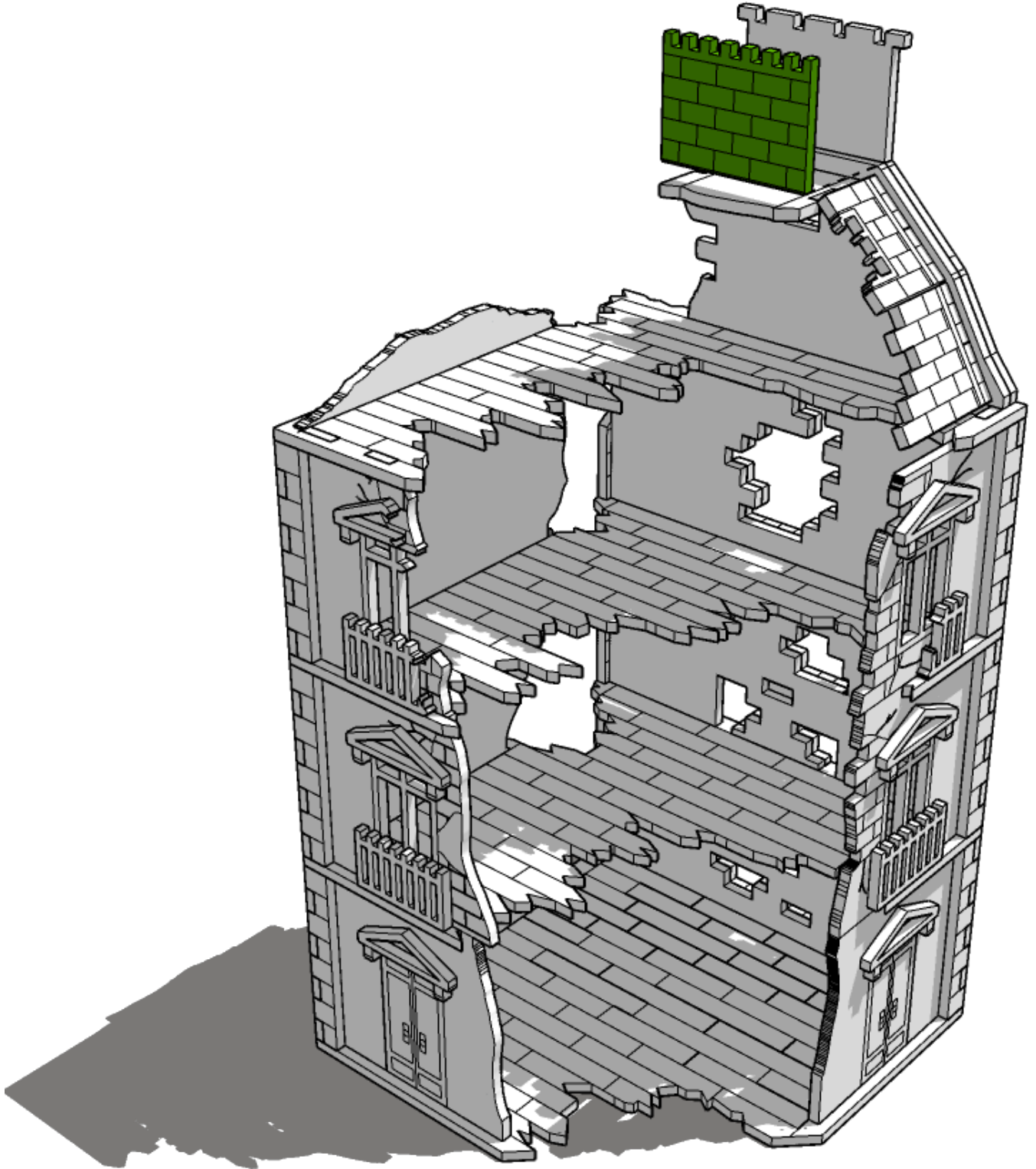



# TABLETOP SCENICS

36

TTSC-WAR-O83  
City, Corner & Delapidated  
Rowhouse Destroyed

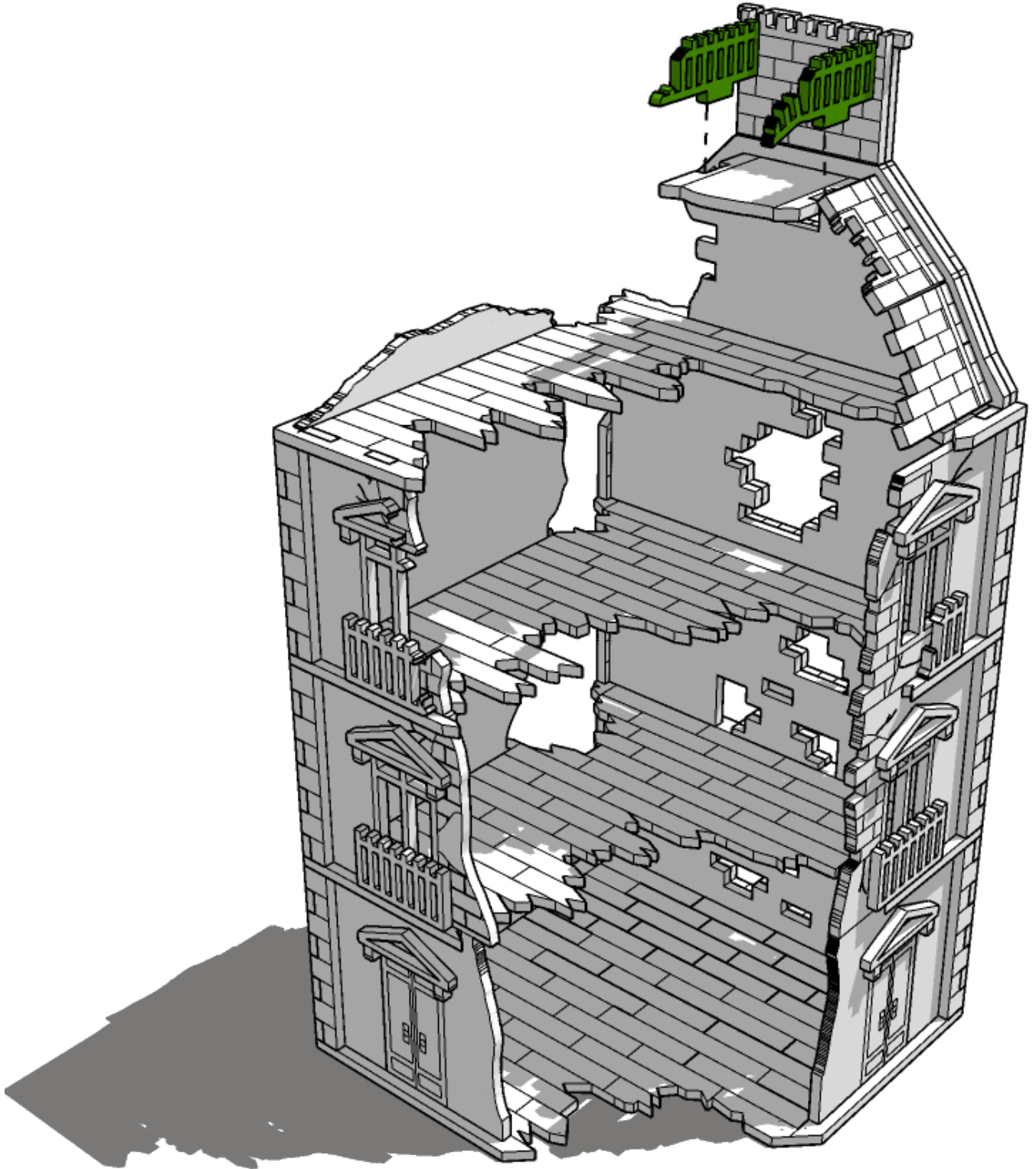



# TABLETOP SCENICS

37

TTSC-WAR-O83  
City, Corner & Delapidated  
Rowhouse Destroyed

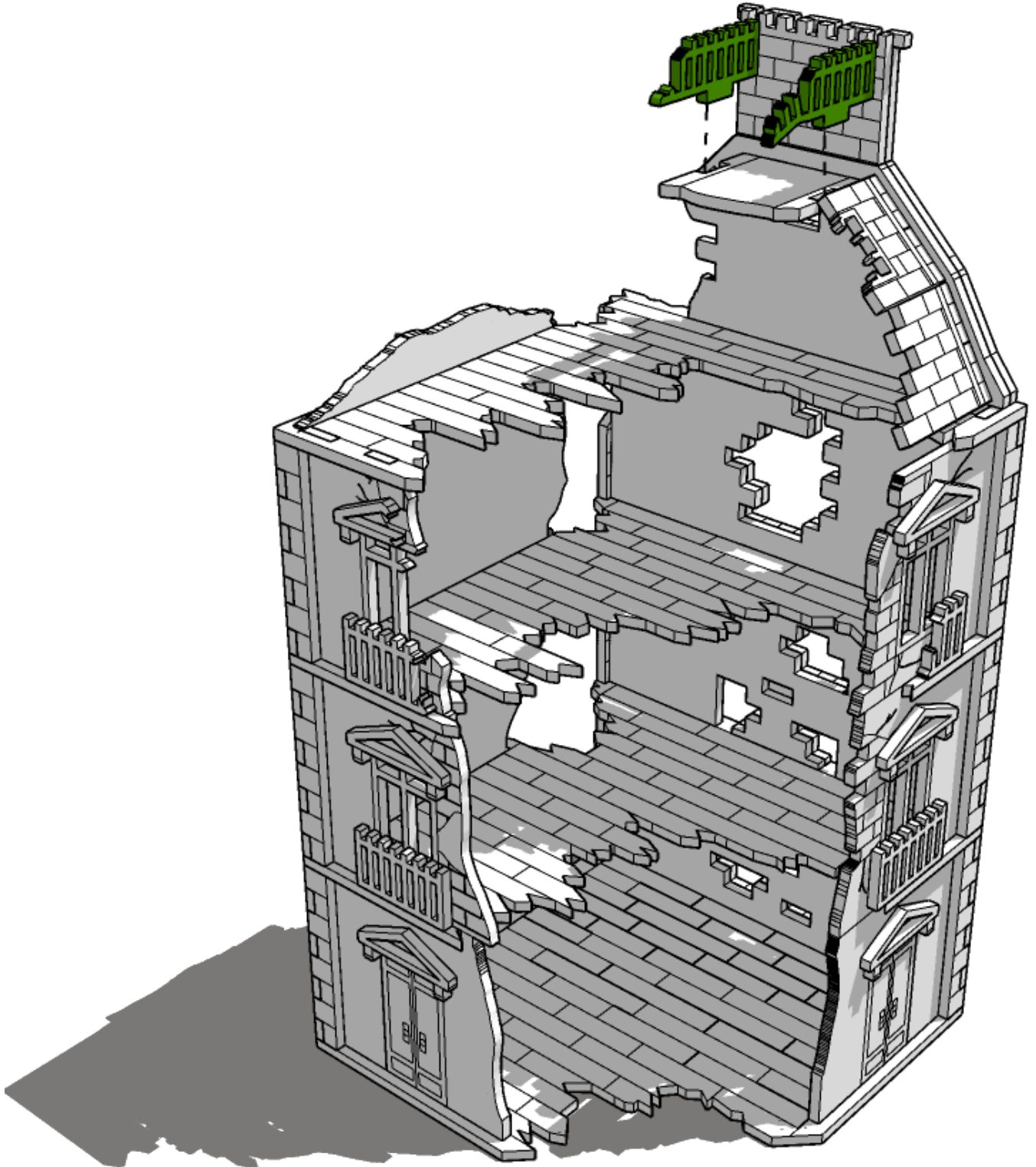



# TABLETOP SCENICS

38

TTSC-WAR-O83  
City, Corner & Delapidated  
Rowhouse Destroyed

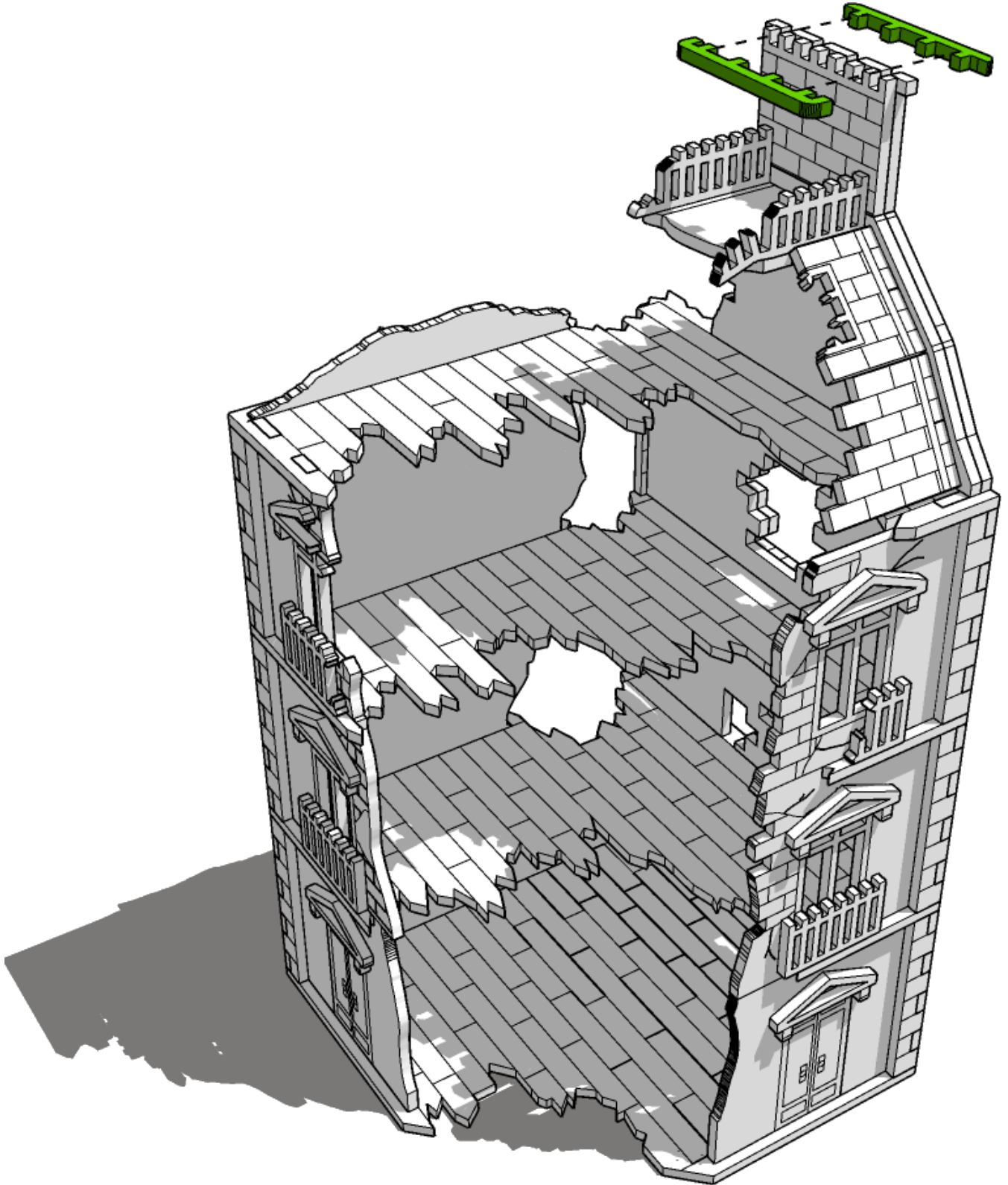



# TABLETOP SCENICS

39

TTSC-WAR-O83  
City, Corner & Delapidated  
Rowhouse Destroyed

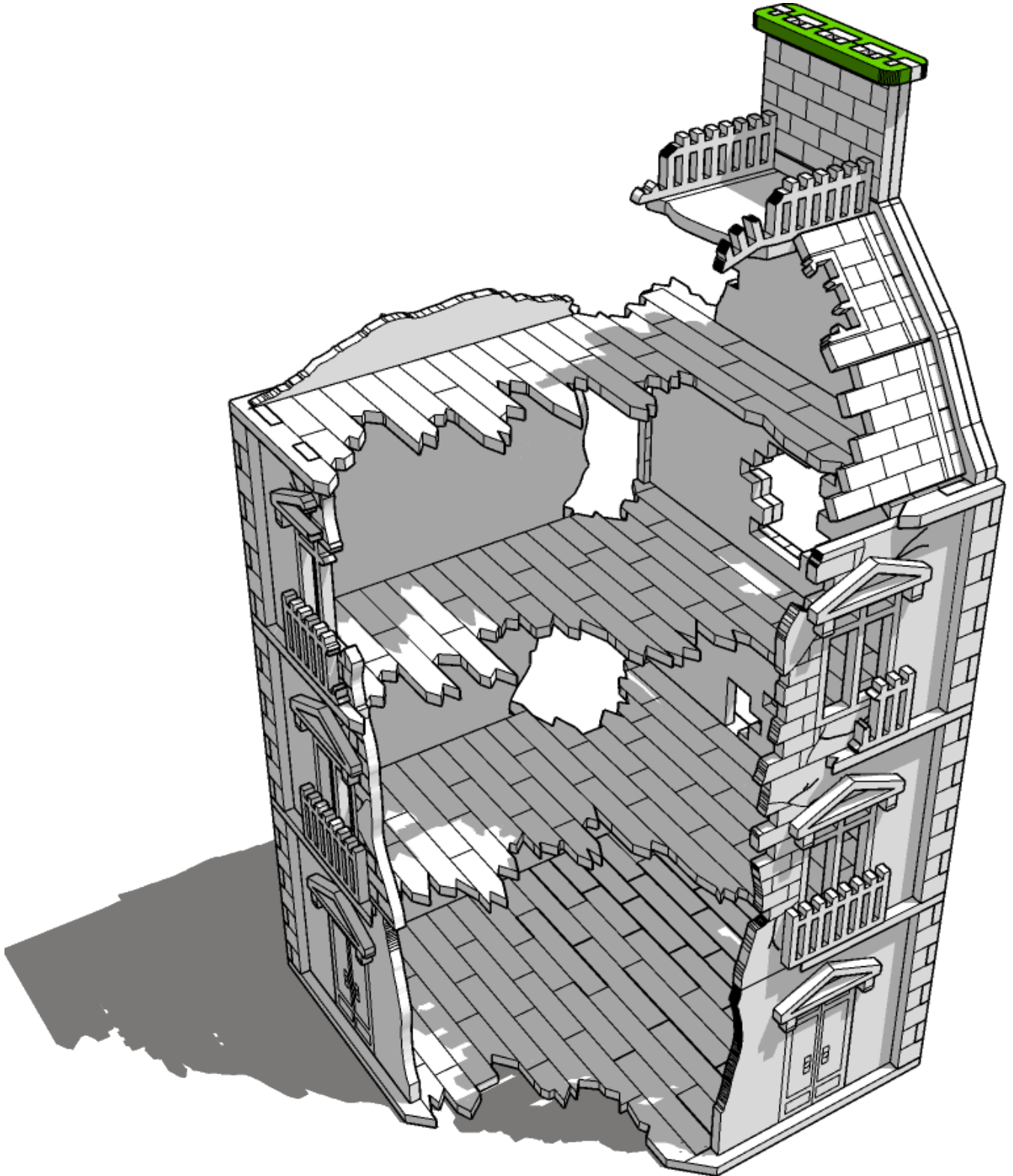





# TABLETOP SCENICS

40

TTSC-WAR-O83  
City, Corner & Delapidated  
Rowhouse Destroyed

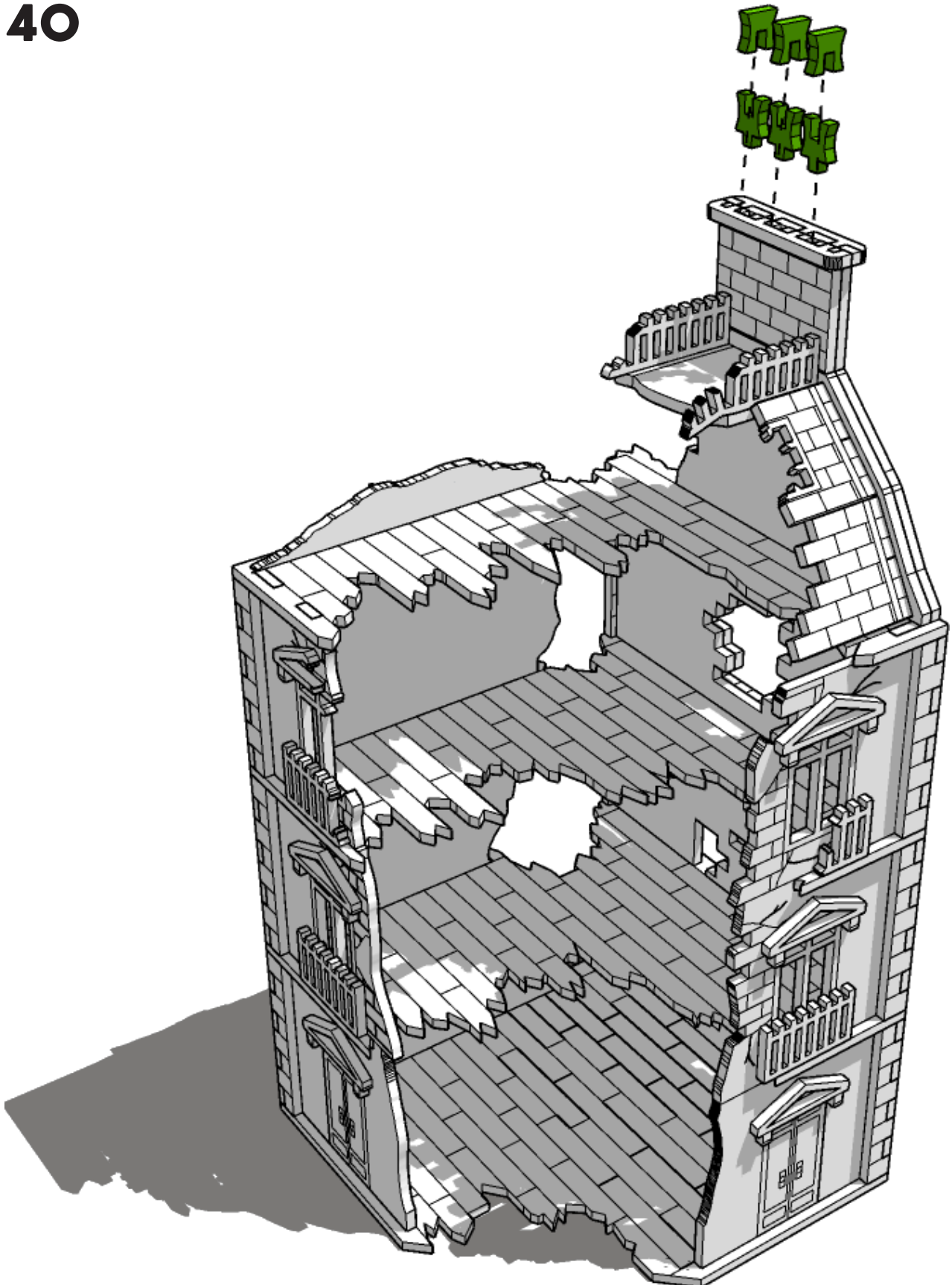



# TABLETOP SCENICS

41

TTSC-WAR-O83  
City, Corner & Delapidated  
Rowhouse Destroyed

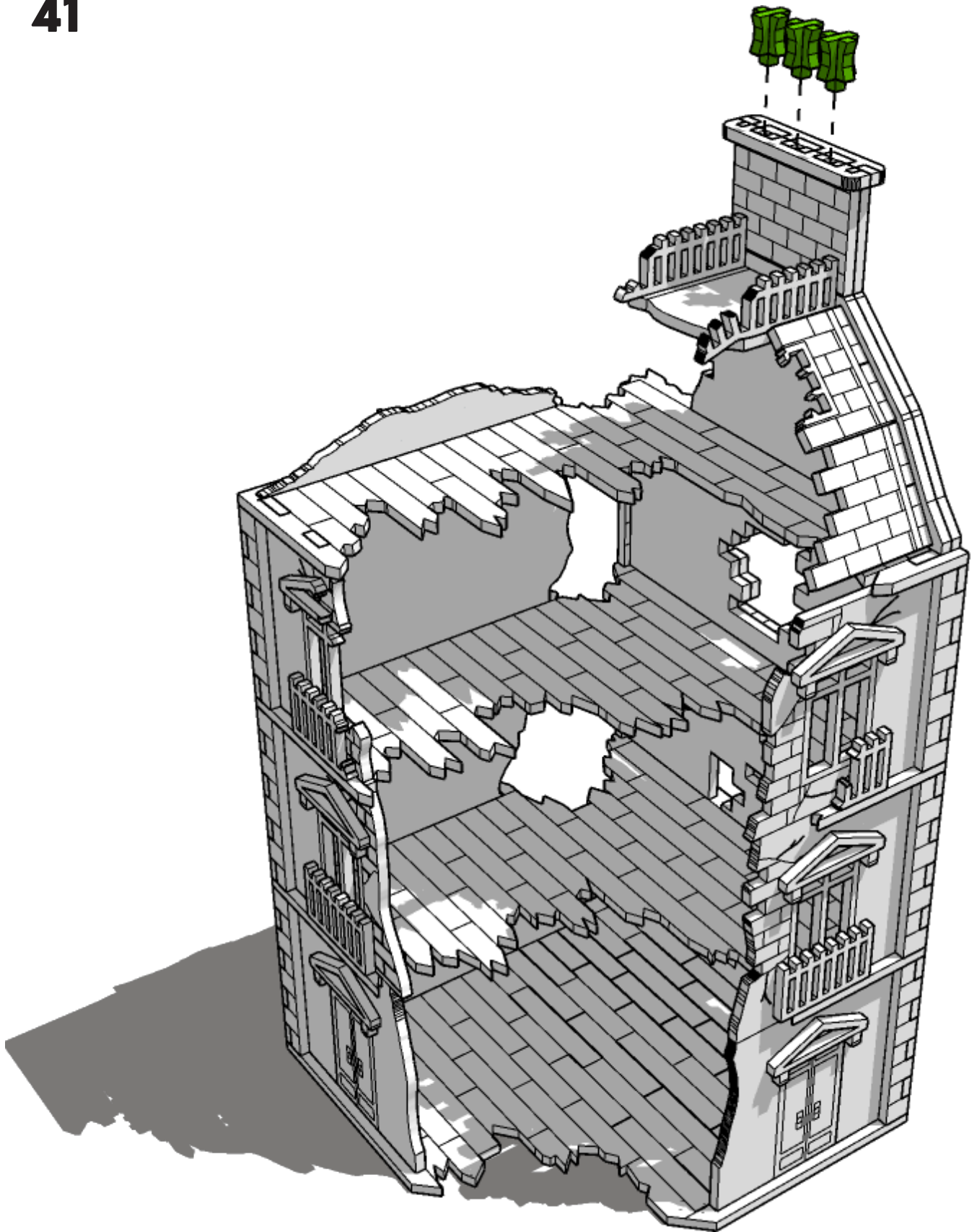



# TABLETOP SCENICS

42

TTSC-WAR-O83  
City, Corner & Delapidated  
Rowhouse Destroyed

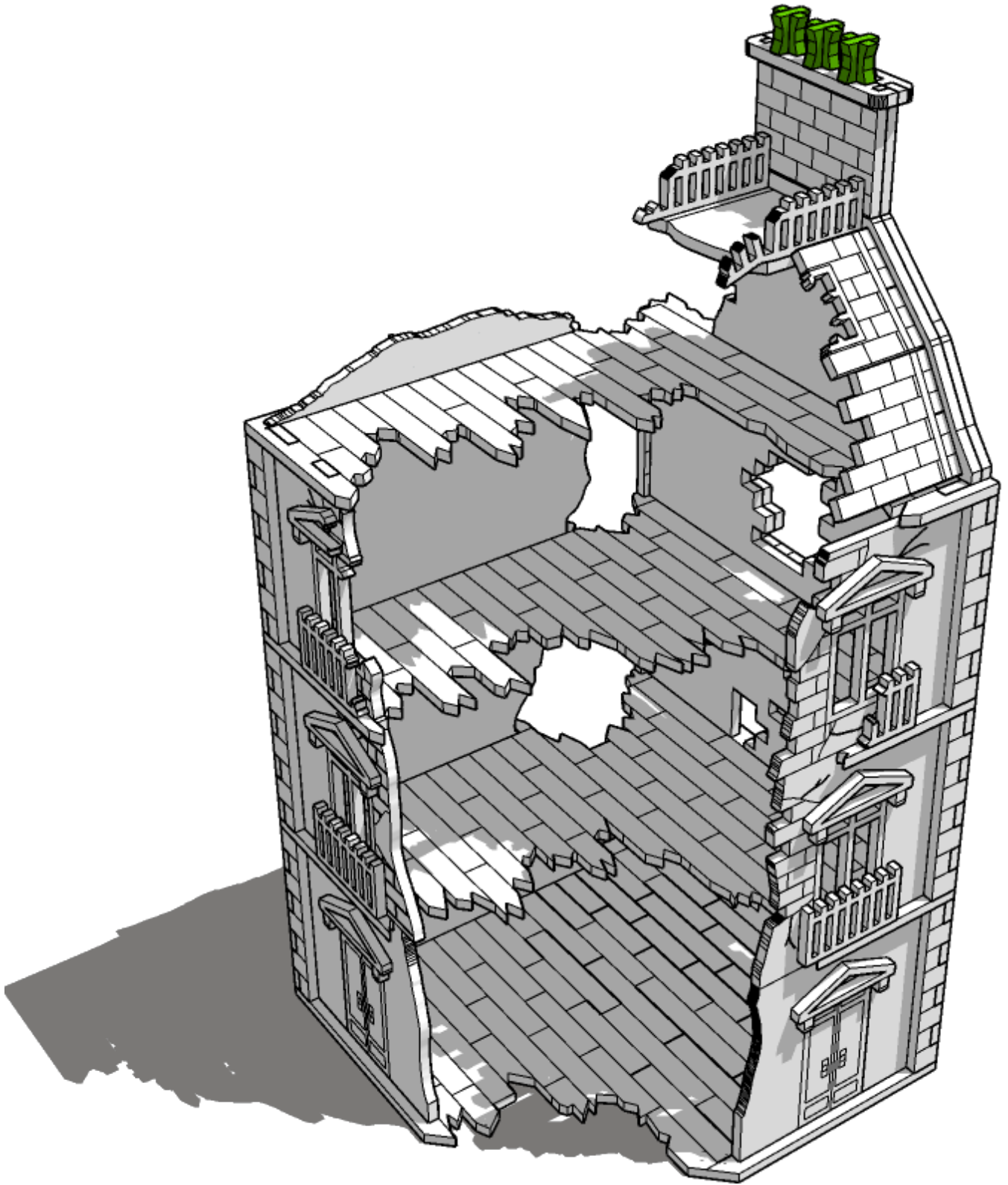



# TABLETOP SCENICS

**TTSC-WAR-O83**  
**City, Corner & Delapidated**  
**Rowhouse Destroyed**

**43**

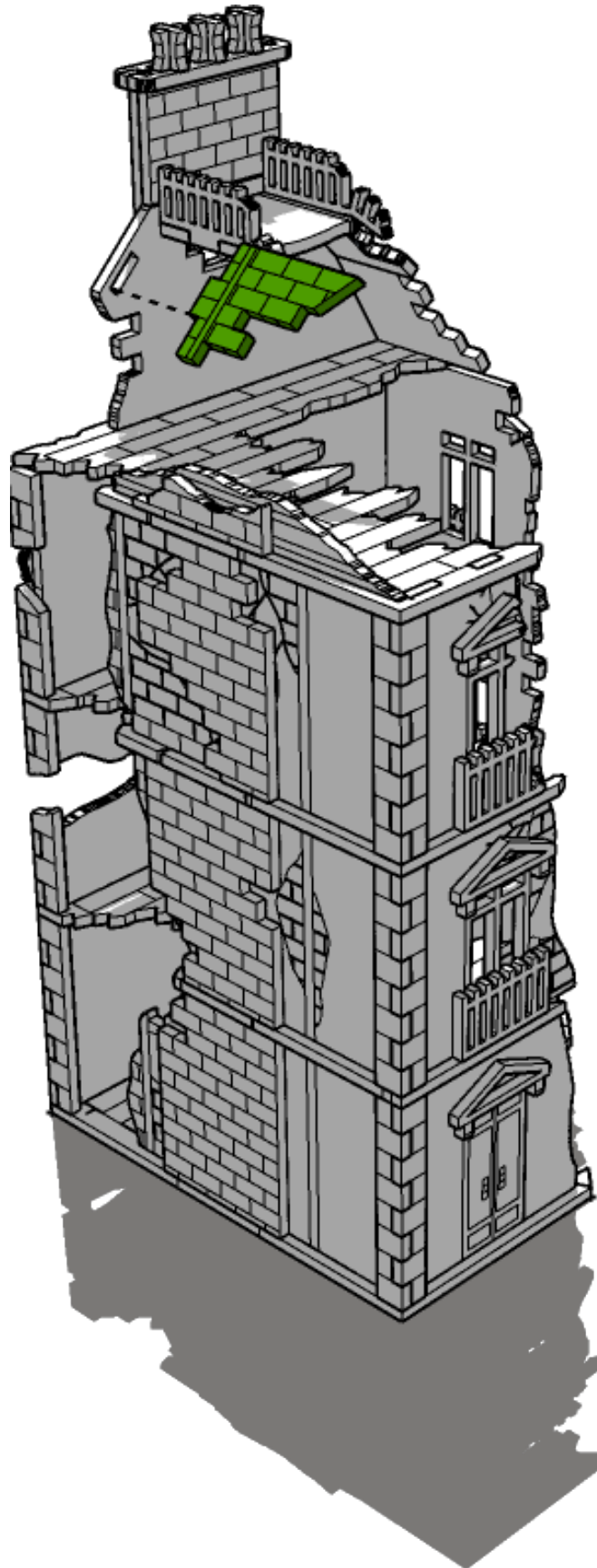



# TABLETOP SCENICS

**TTSC-WAR-O83**  
**City, Corner & Delapidated**  
**Rowhouse Destroyed**

**44**

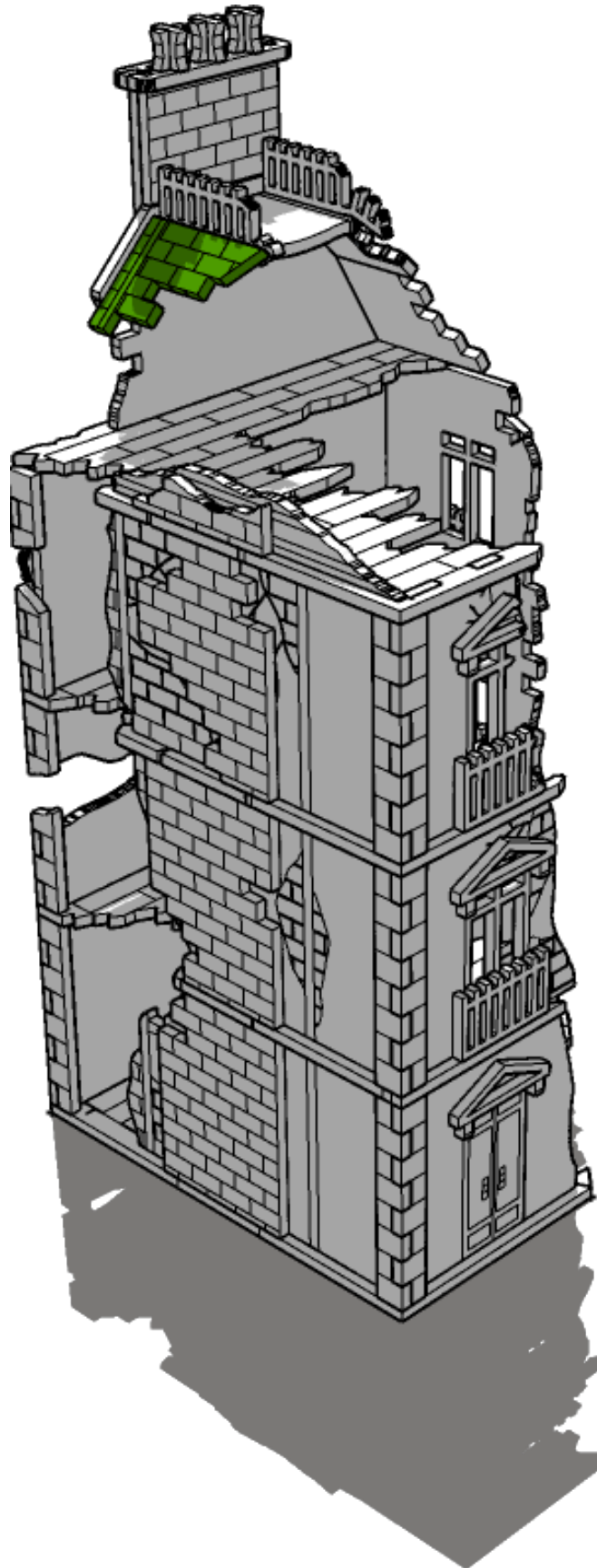



# TABLETOP SCENICS

TTSC-WAR-O83  
City, Corner & Delapidated  
Rowhouse Destroyed

45

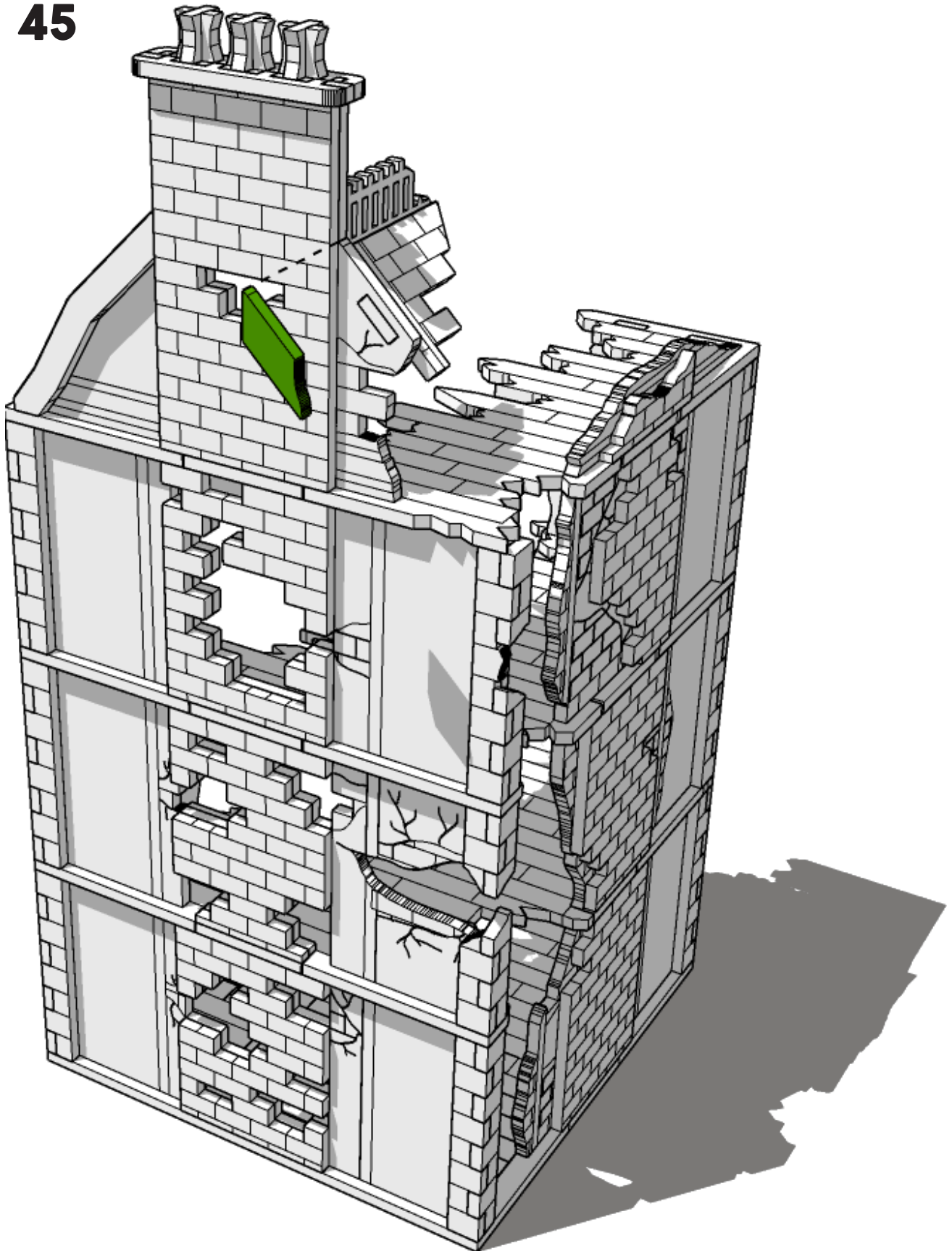



# TABLETOP SCENICS

TTSC-WAR-083  
City, Corner & Delapidated  
Rowhouse Destroyed

46

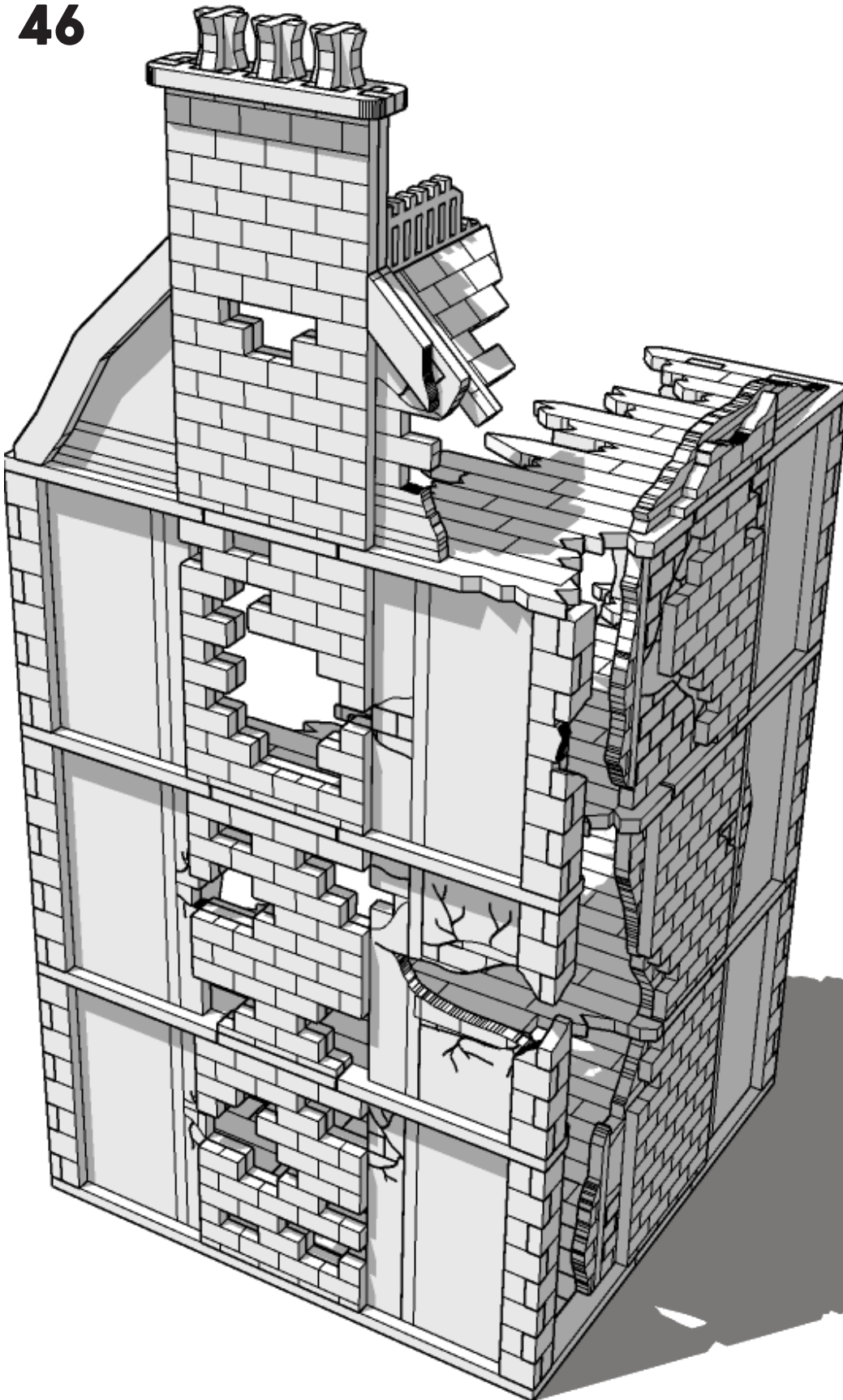



TABLETOP  
**SCENICS**

**TTSC-WAR-O83**  
**City, Corner & Delapidated**  
**Rowhouse Destroyed**

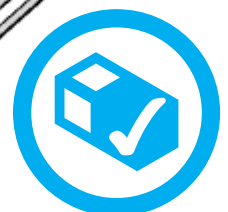
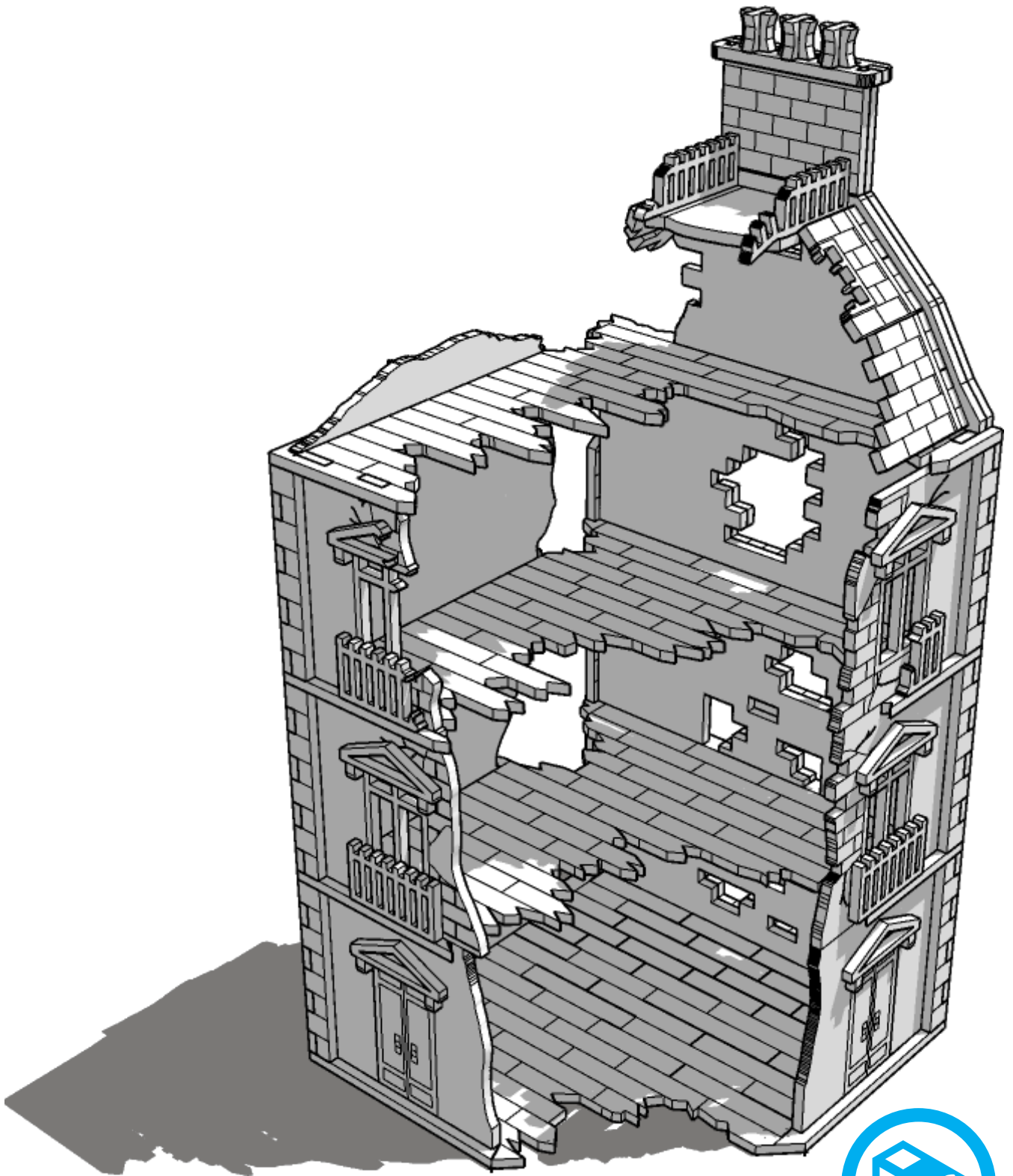

 **TTCOMBAT**





# TABLETOP SCENICS

48

TTSC-WAR-O83  
City, Corner & Delapidated  
Rowhouse Destroyed

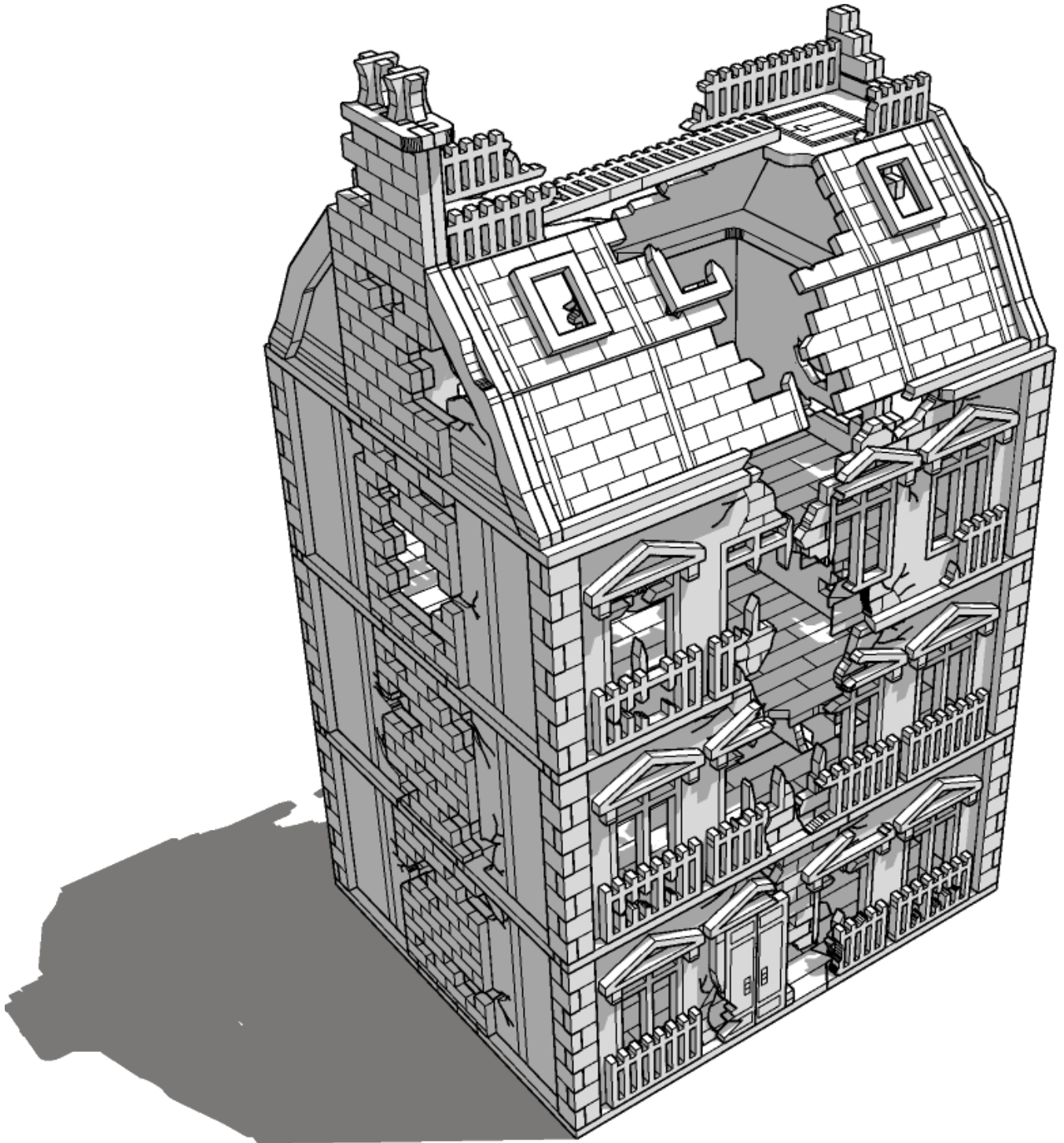



# TABLETOP SCENICS

49

TTSC-WAR-O83  
City, Corner & Delapidated  
Rowhouse Destroyed

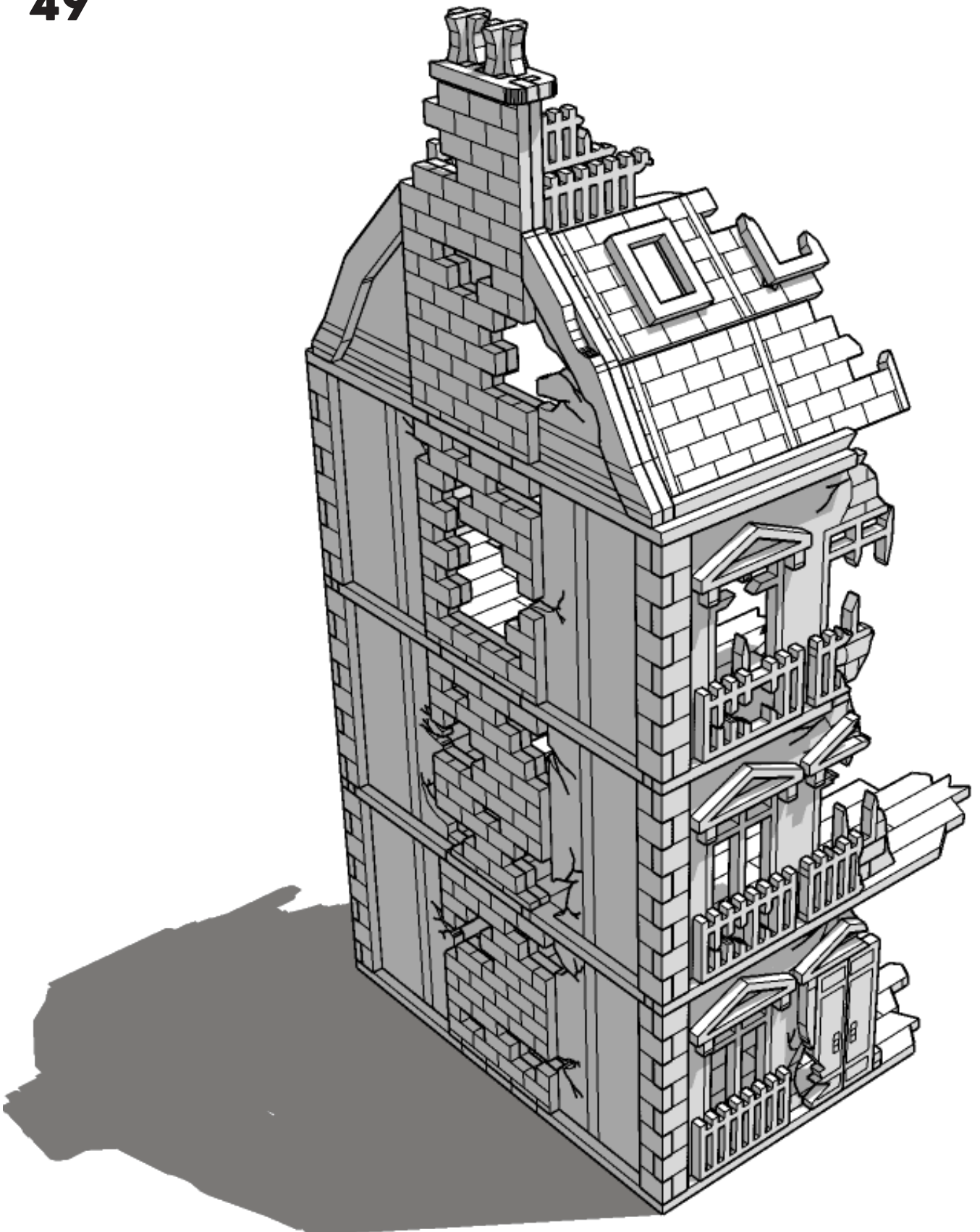



# TABLETOP SCENICS

**TTSC-WAR-O83**  
**City, Corner & Delapidated**  
**Rowhouse Destroyed**

**50**

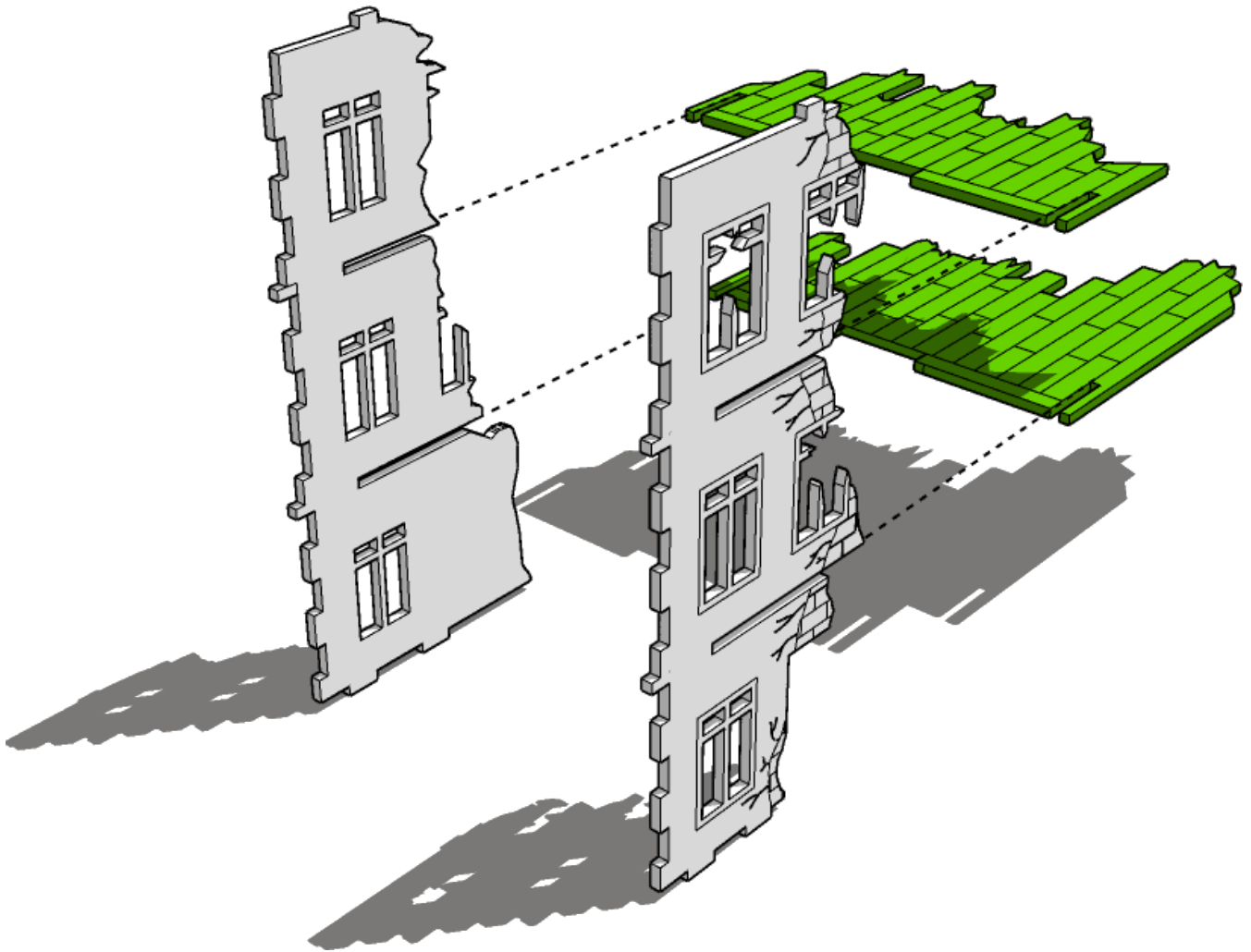



# TABLETOP SCENICS

**TTSC-WAR-O83**  
**City, Corner & Delapidated**  
**Rowhouse Destroyed**

**51**

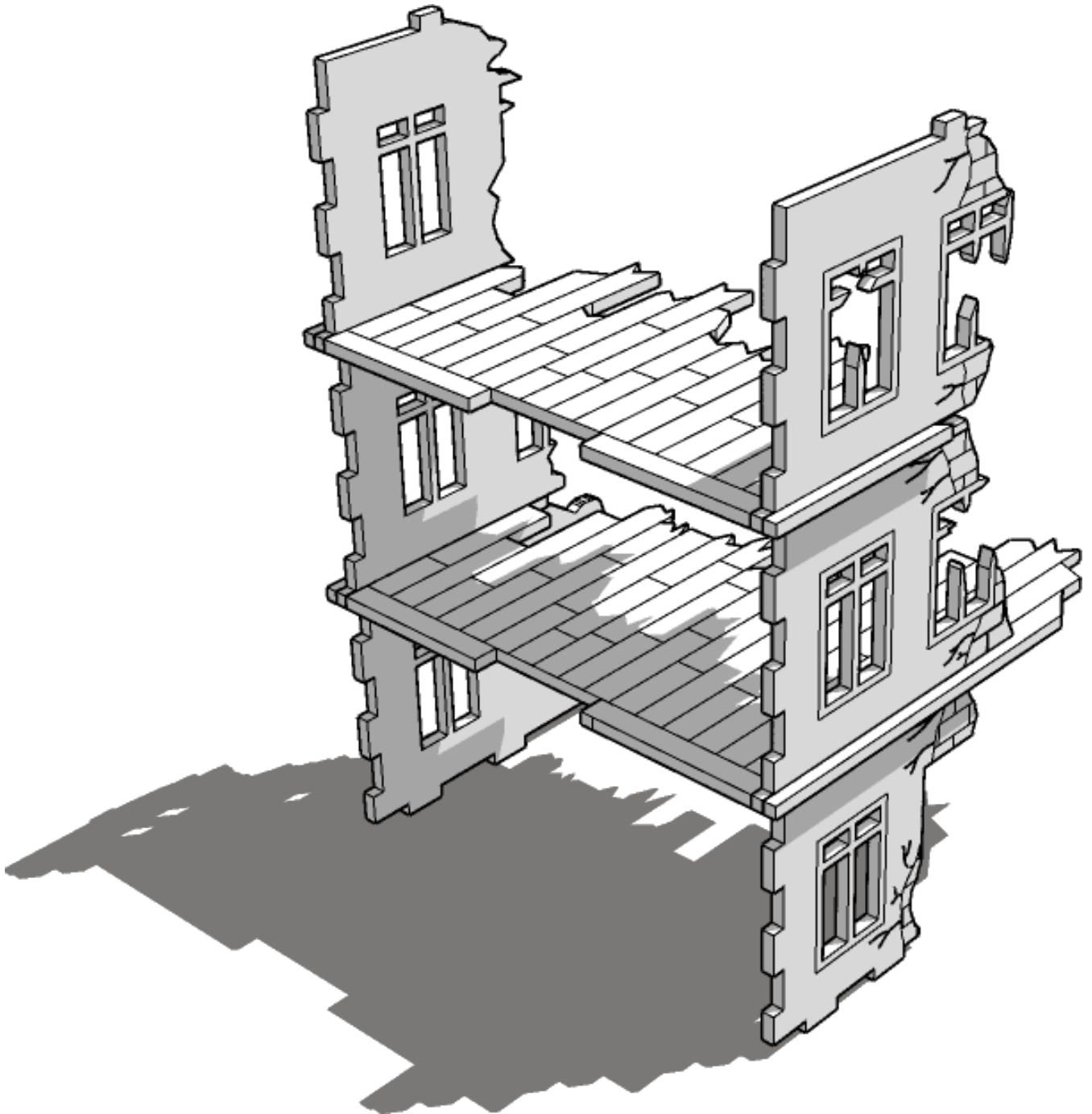



# TABLETOP SCENICS

**TTSC-WAR-O83**  
**City, Corner & Delapidated**  
**Rowhouse Destroyed**

**52**

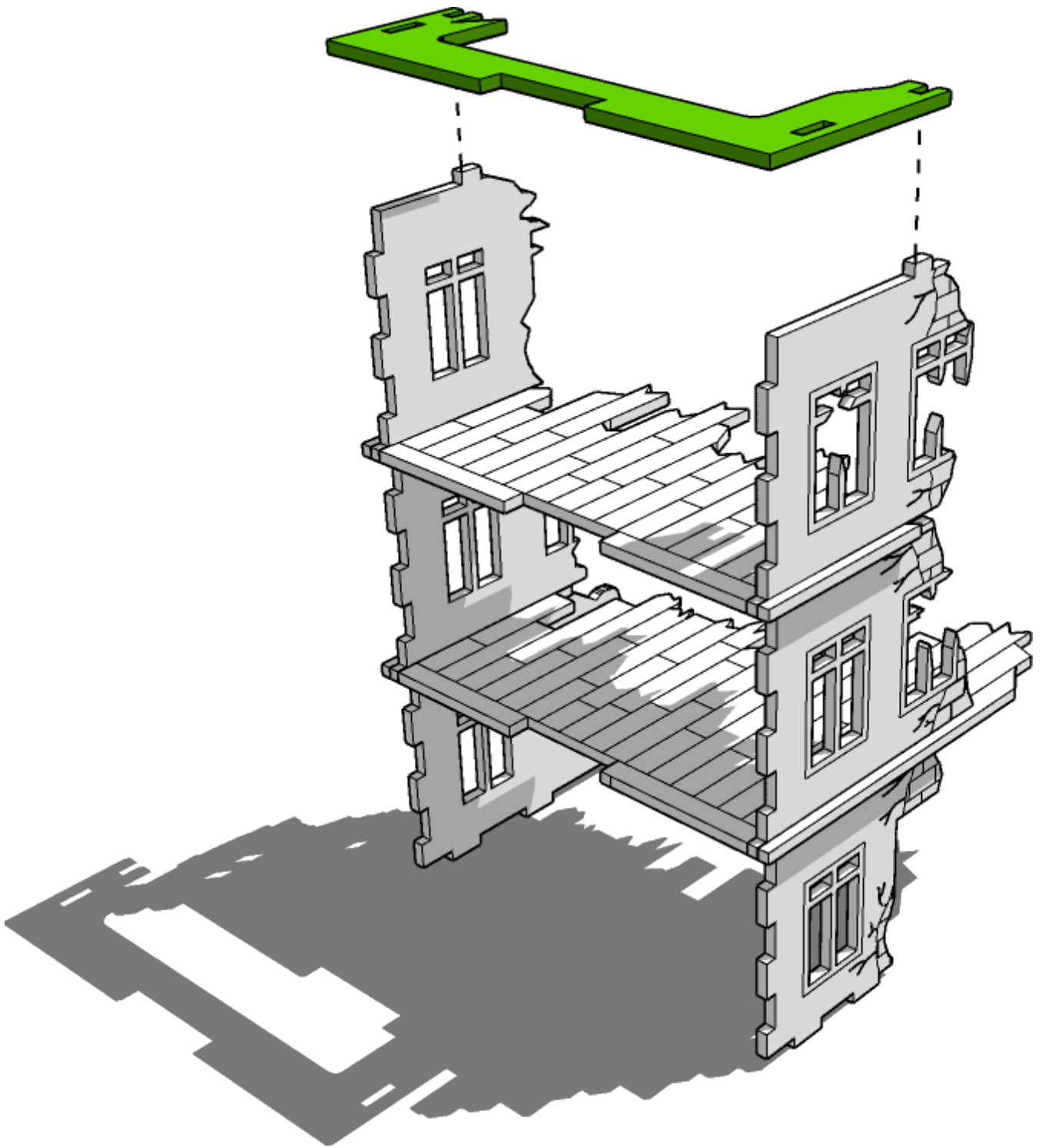



# TABLETOP SCENICS

**TTSC-WAR-O83**  
**City, Corner & Delapidated**  
**Rowhouse Destroyed**

**53**

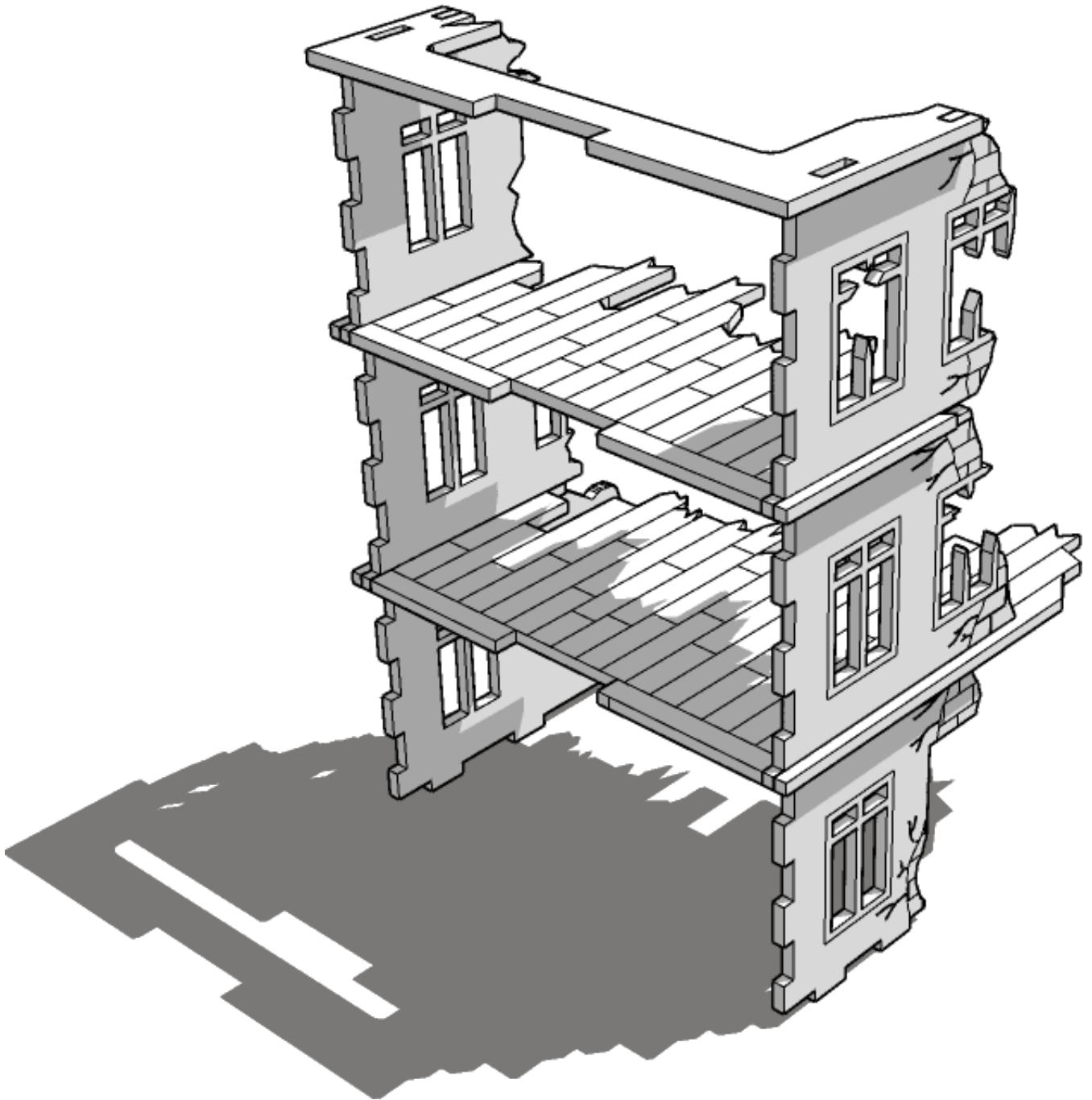



# TABLETOP SCENICS

**TTSC-WAR-O83**  
**City, Corner & Delapidated**  
**Rowhouse Destroyed**

**54**

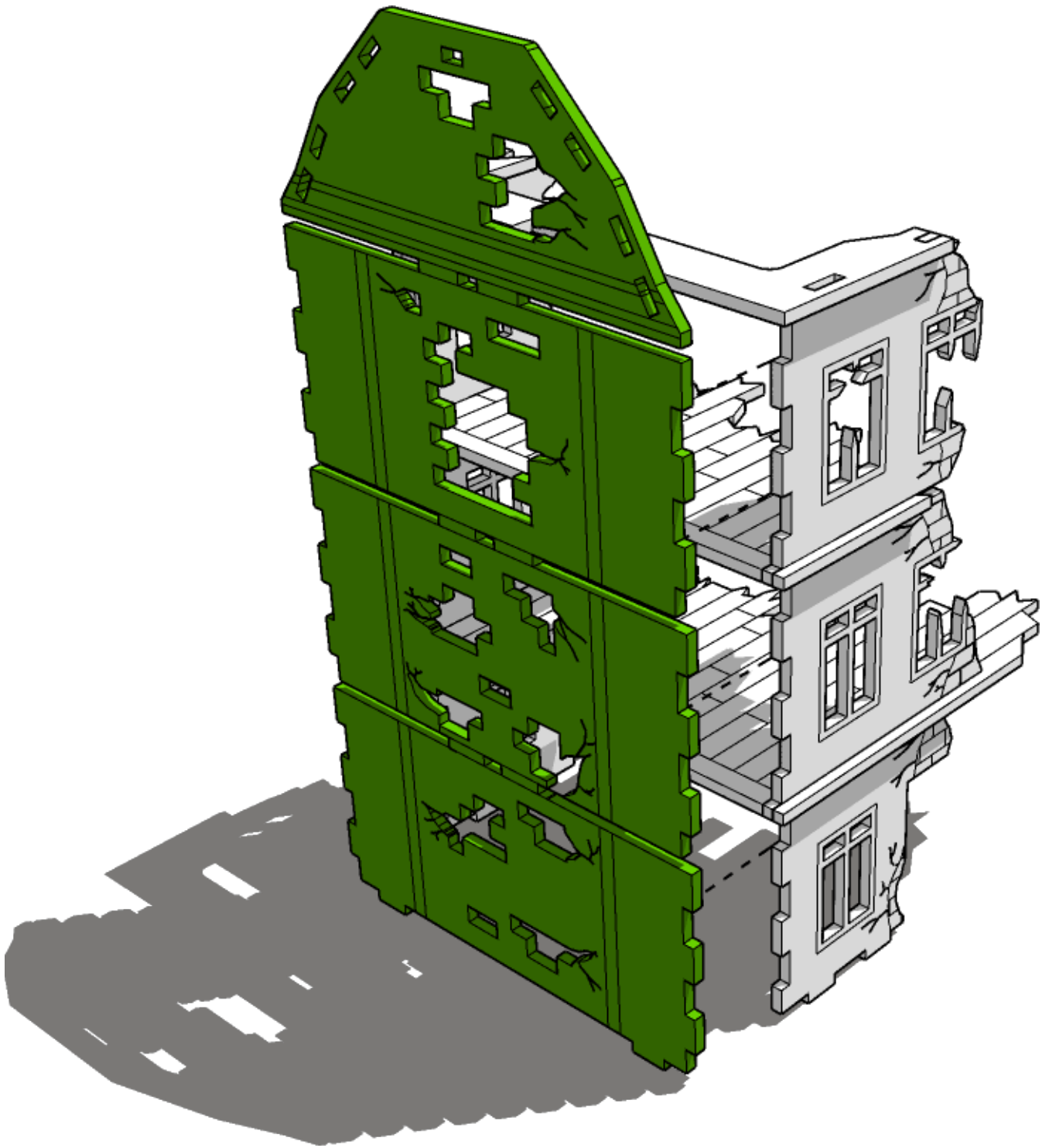



# TABLETOP SCENICS

**TTSC-WAR-O83**  
**City, Corner & Delapidated**  
**Rowhouse Destroyed**

**55**

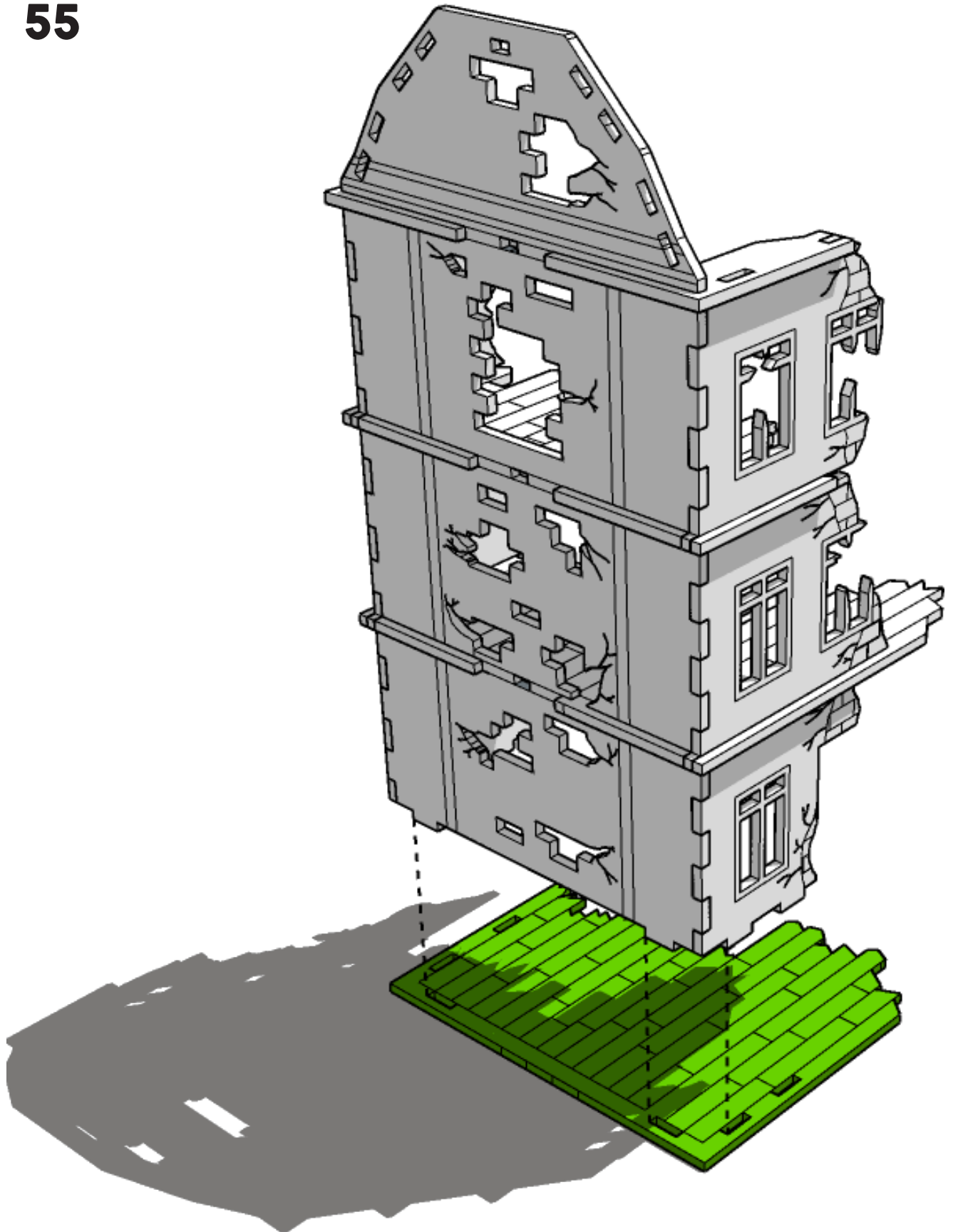





# TABLETOP SCENICS

**TTSC-WAR-083**  
**City, Corner & Delapidated**  
**Rowhouse Destroyed**

**56**

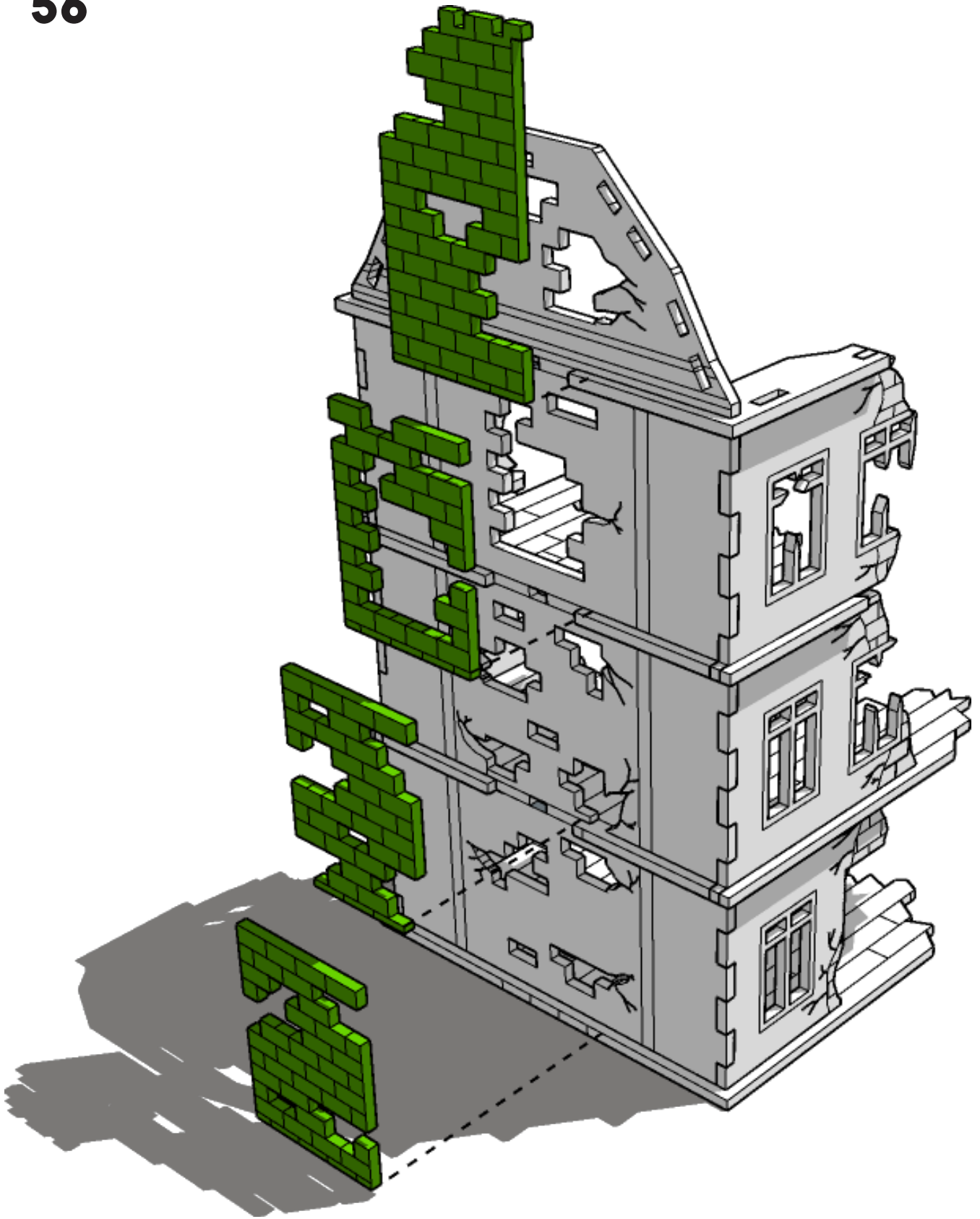



# TABLETOP SCENICS

**TTSC-WAR-O83**  
**City, Corner & Delapidated**  
**Rowhouse Destroyed**

**57**

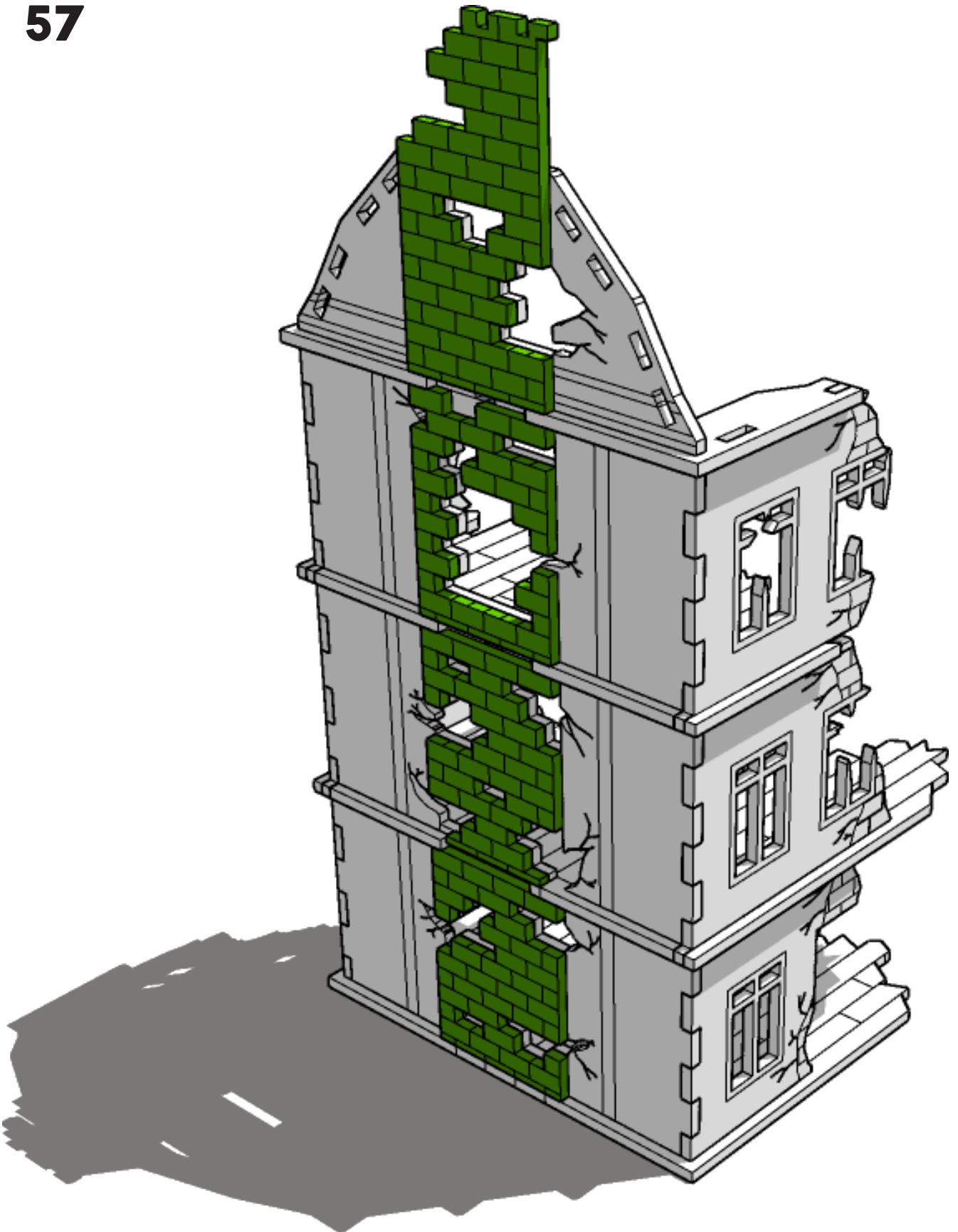



# TABLETOP SCENICS

**TTSC-WAR-O83**  
**City, Corner & Delapidated**  
**Rowhouse Destroyed**

**58**

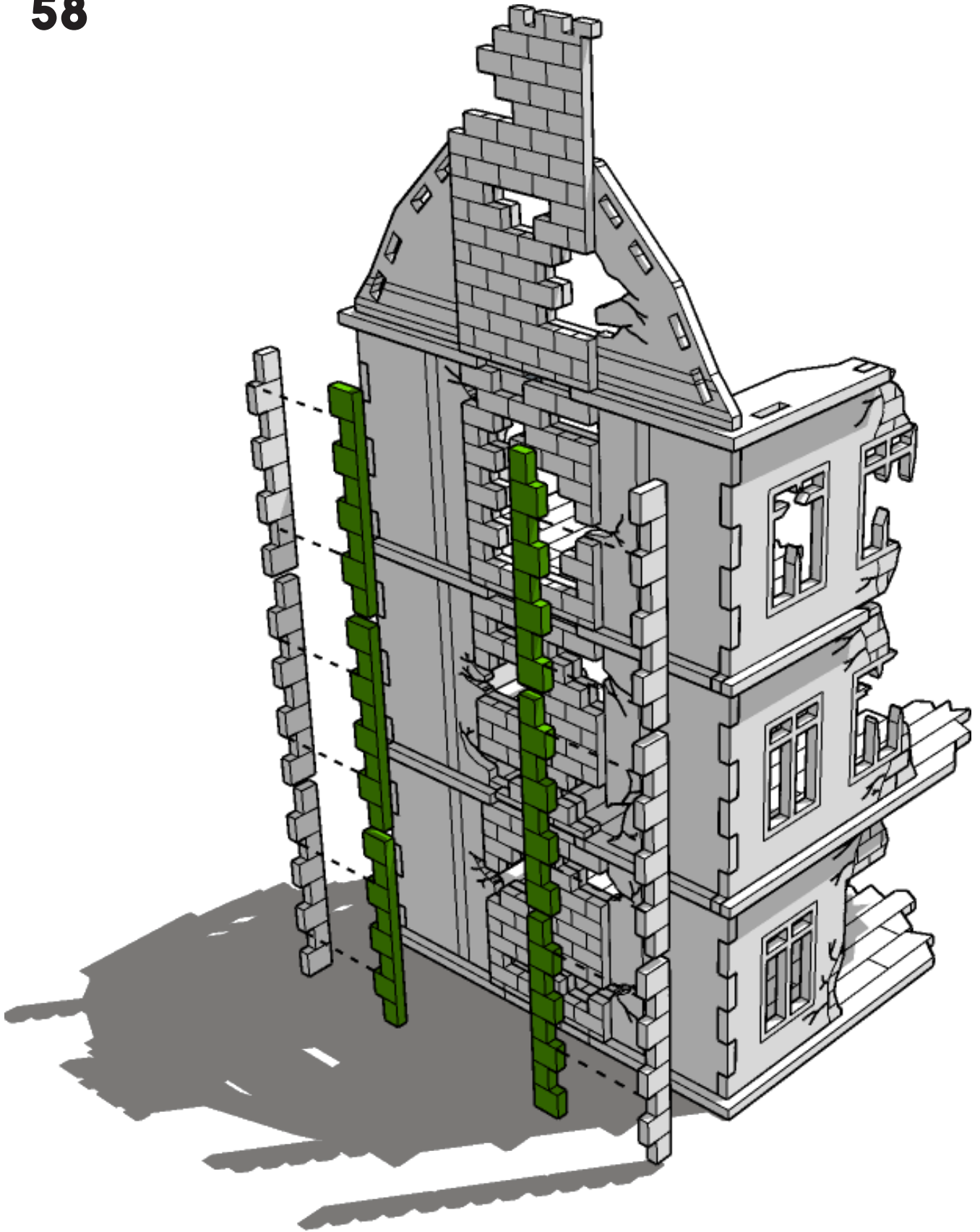



# TABLETOP SCENICS

**TTSC-WAR-O83**  
**City, Corner & Delapidated**  
**Rowhouse Destroyed**

**59**

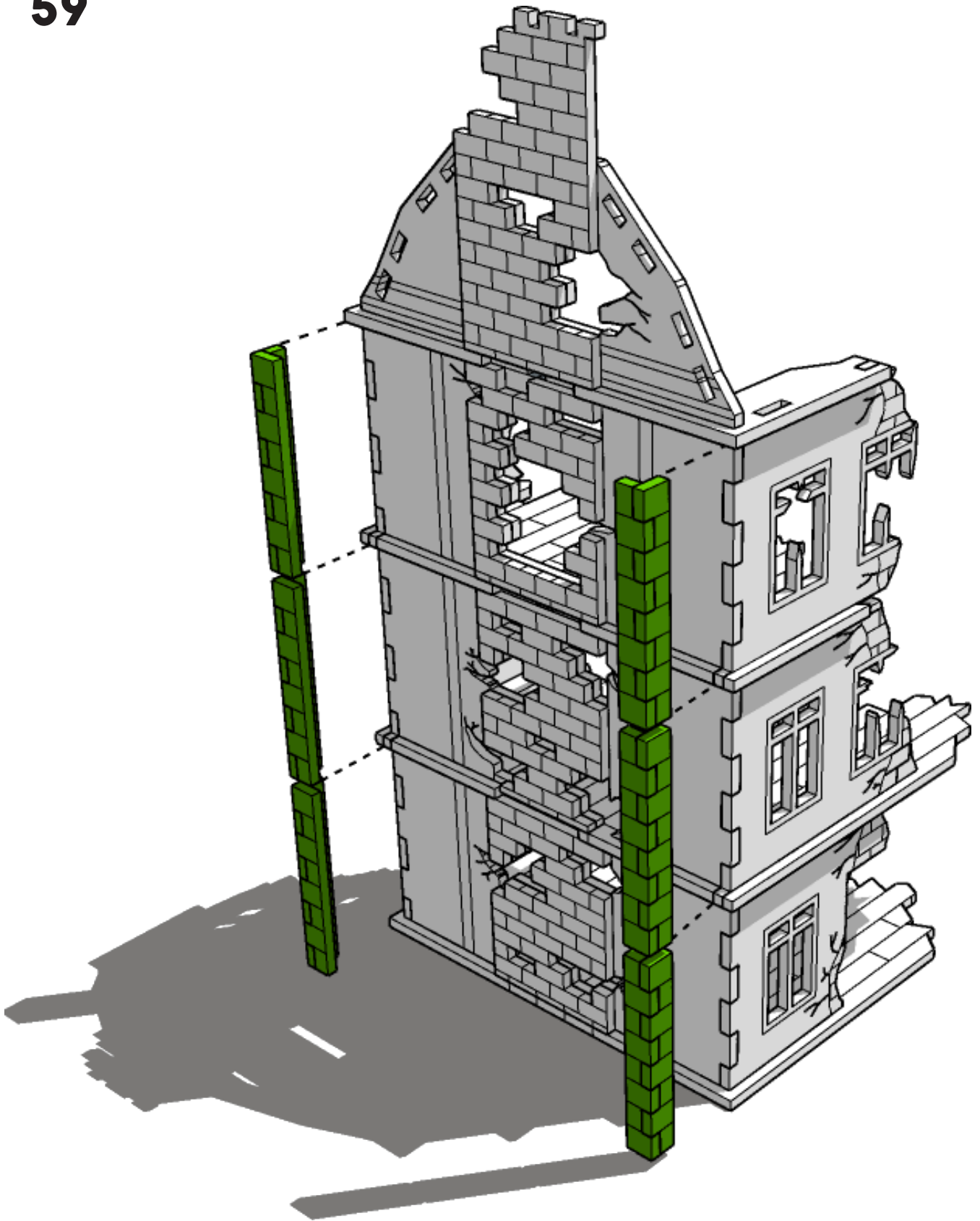



# TABLETOP SCENICS

60

TTSC-WAR-083  
City, Corner & Delapidated  
Rowhouse Destroyed

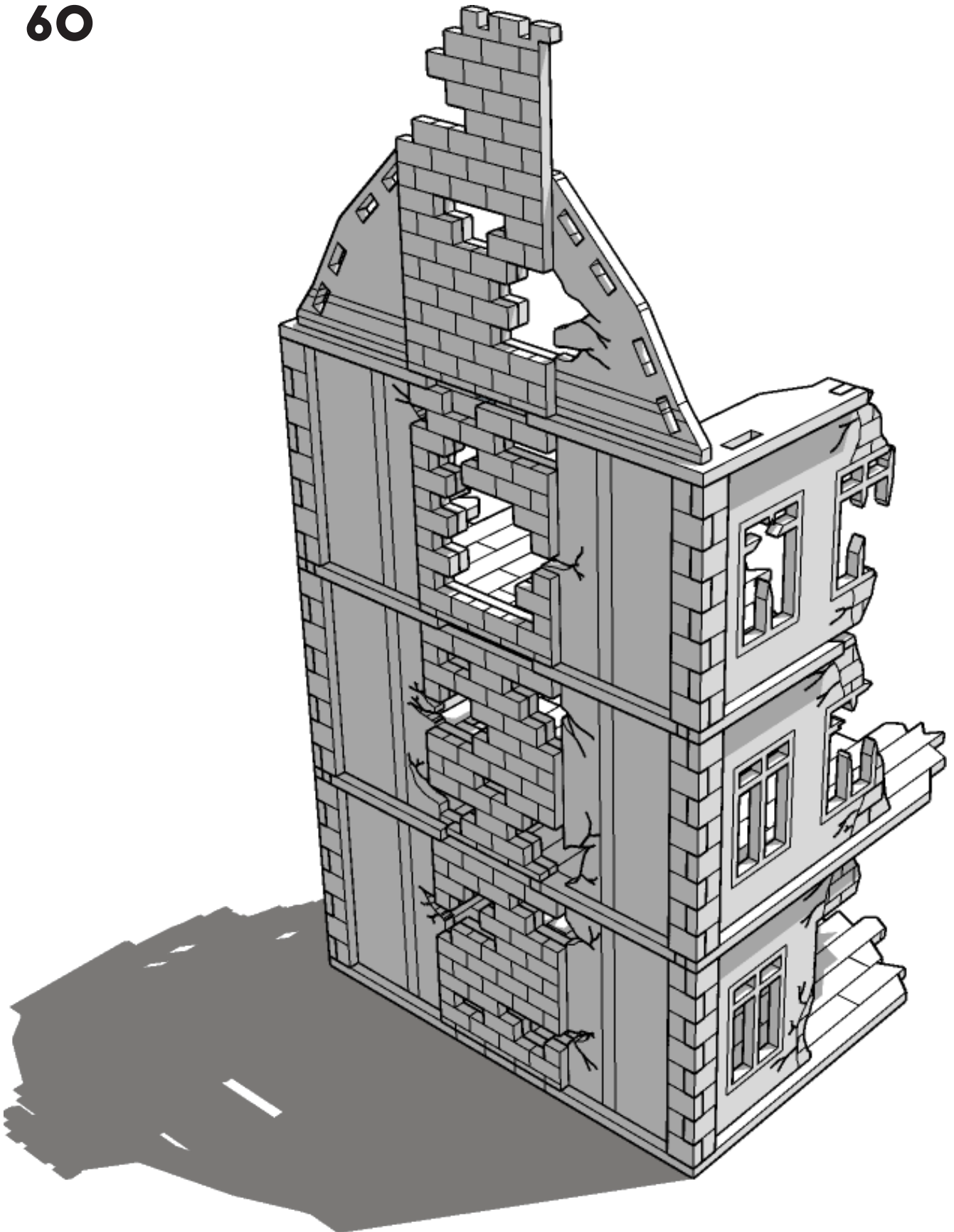



# TABLETOP SCENICS

**TTSC-WAR-O83**  
**City, Corner & Delapidated**  
**Rowhouse Destroyed**

**61**

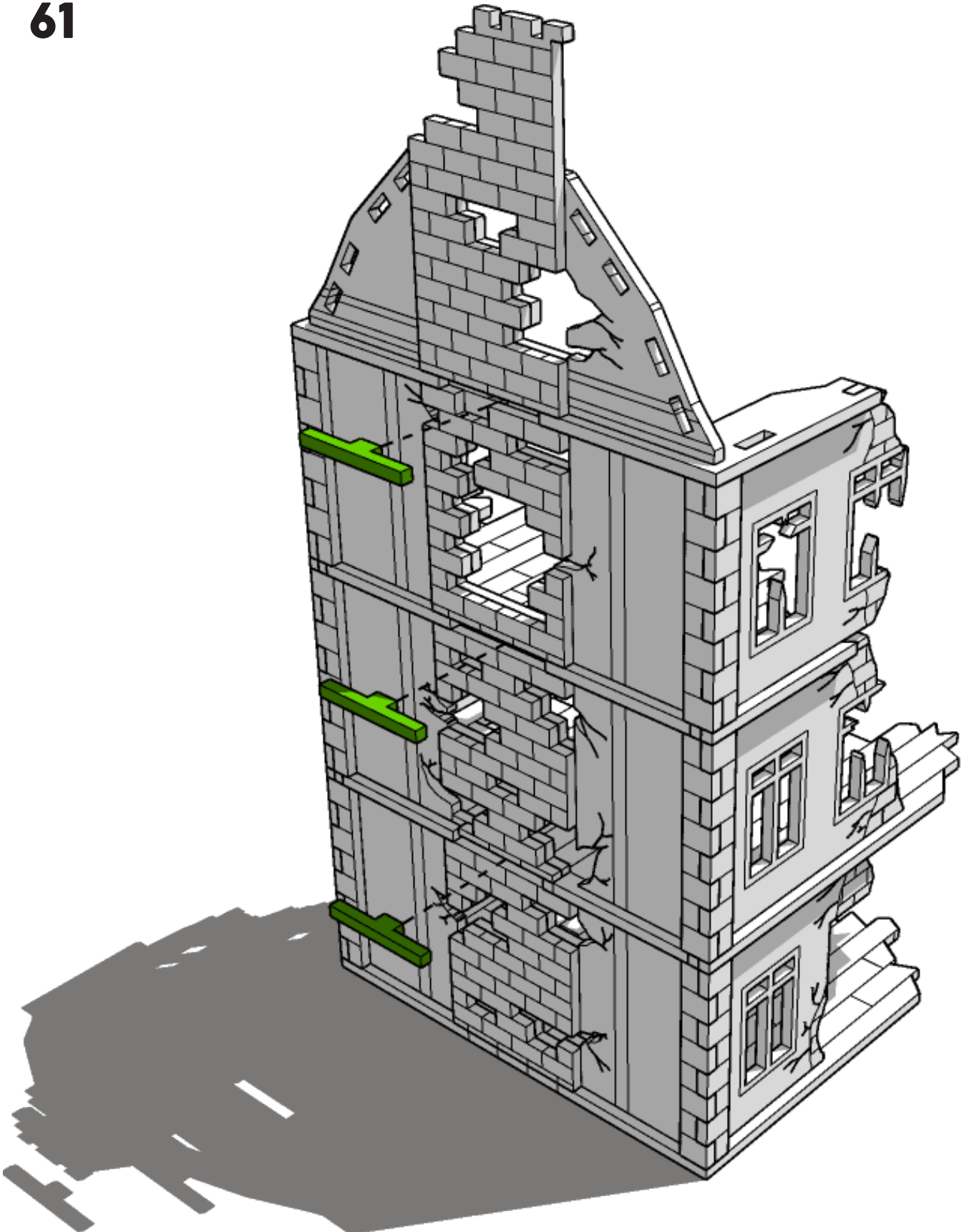



# TABLETOP SCENICS

**TTSC-WAR-083**  
**City, Corner & Delapidated**  
**Rowhouse Destroyed**

**62**

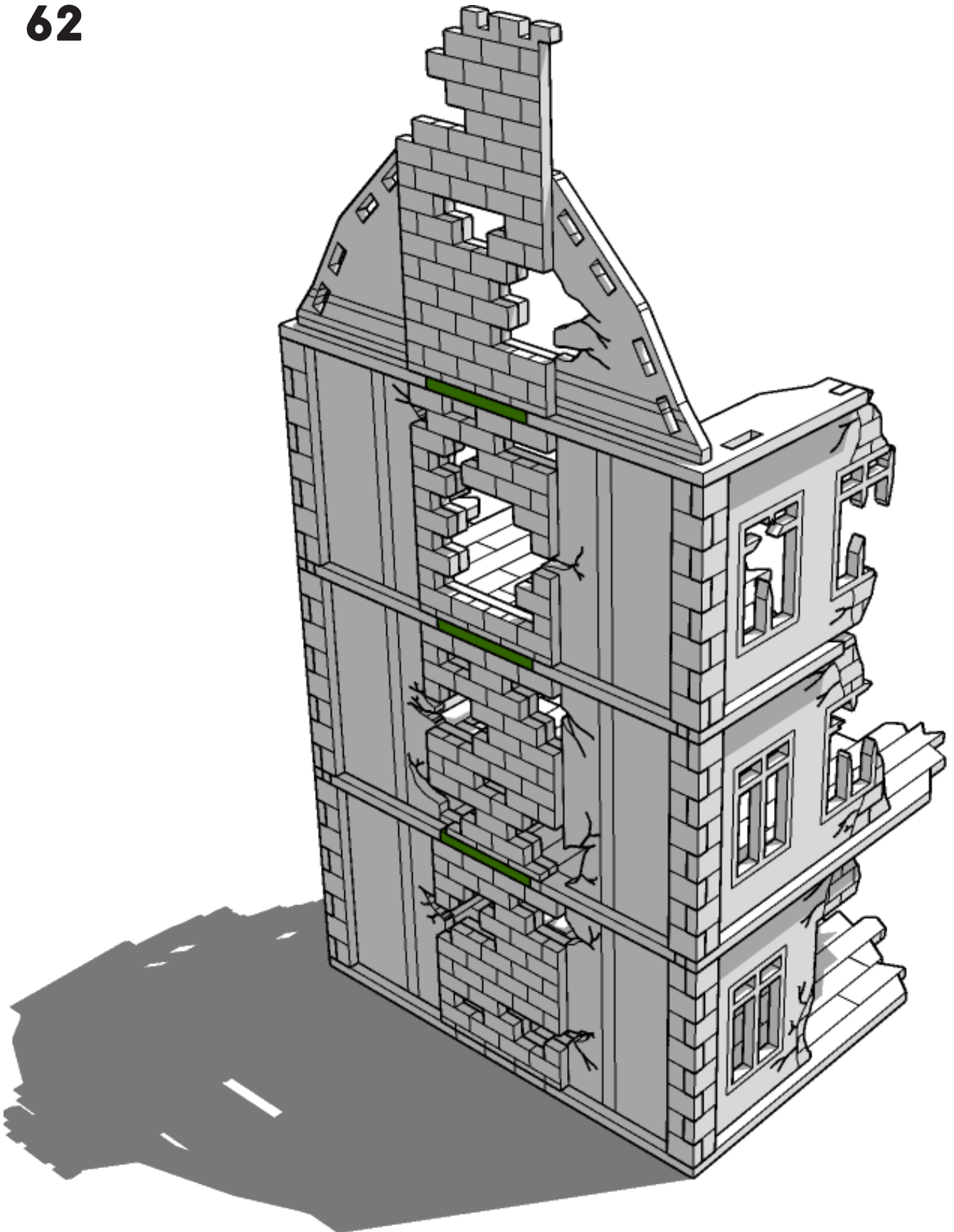



# TABLETOP SCENICS

**TTSC-WAR-O83**  
**City, Corner & Delapidated**  
**Rowhouse Destroyed**

**63**

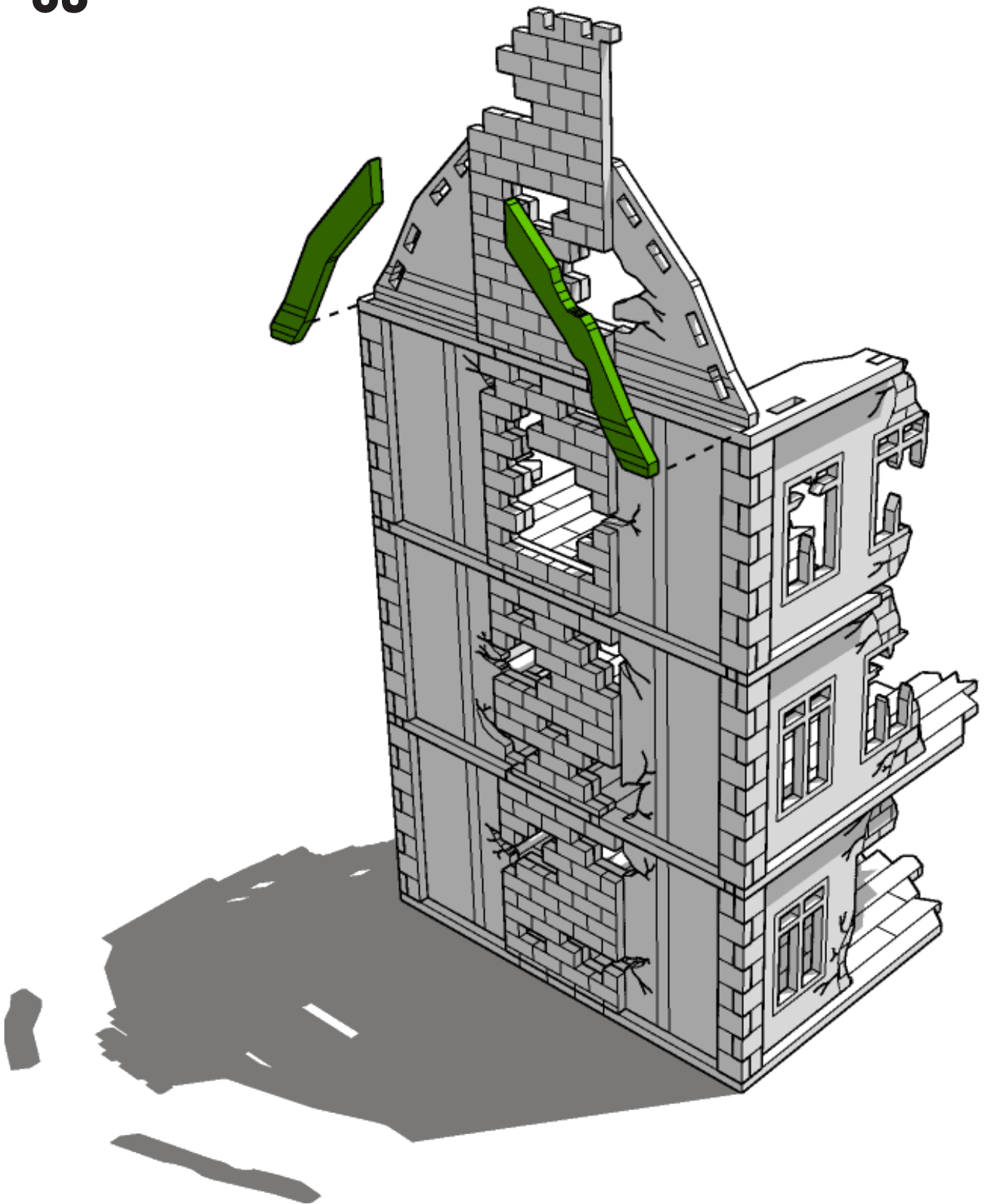





# TABLETOP SCENICS

**TTSC-WAR-O83**  
**City, Corner & Delapidated**  
**Rowhouse Destroyed**

**64**

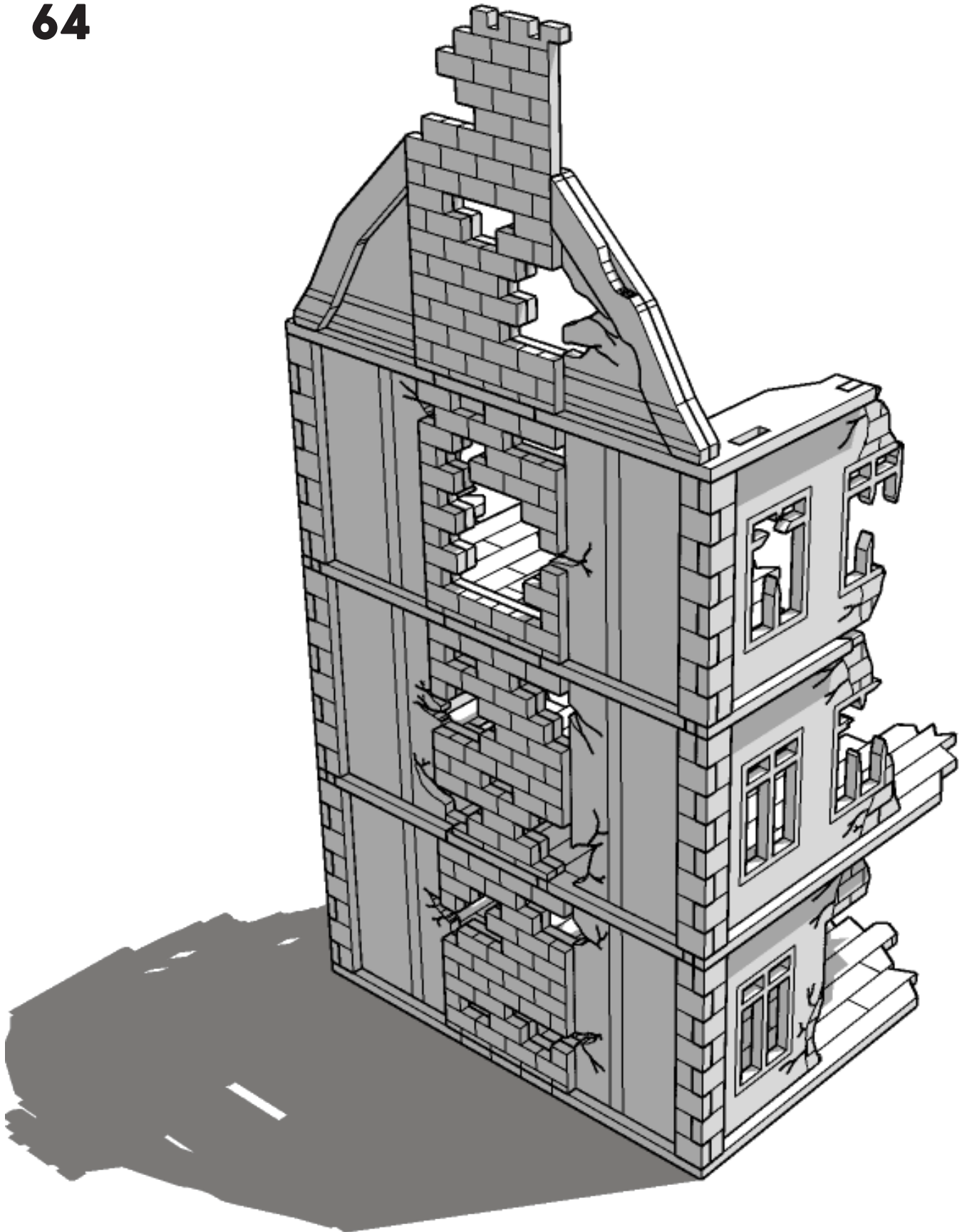



# TABLETOP SCENICS

**TTSC-WAR-O83**  
**City, Corner & Delapidated**  
**Rowhouse Destroyed**

**65**

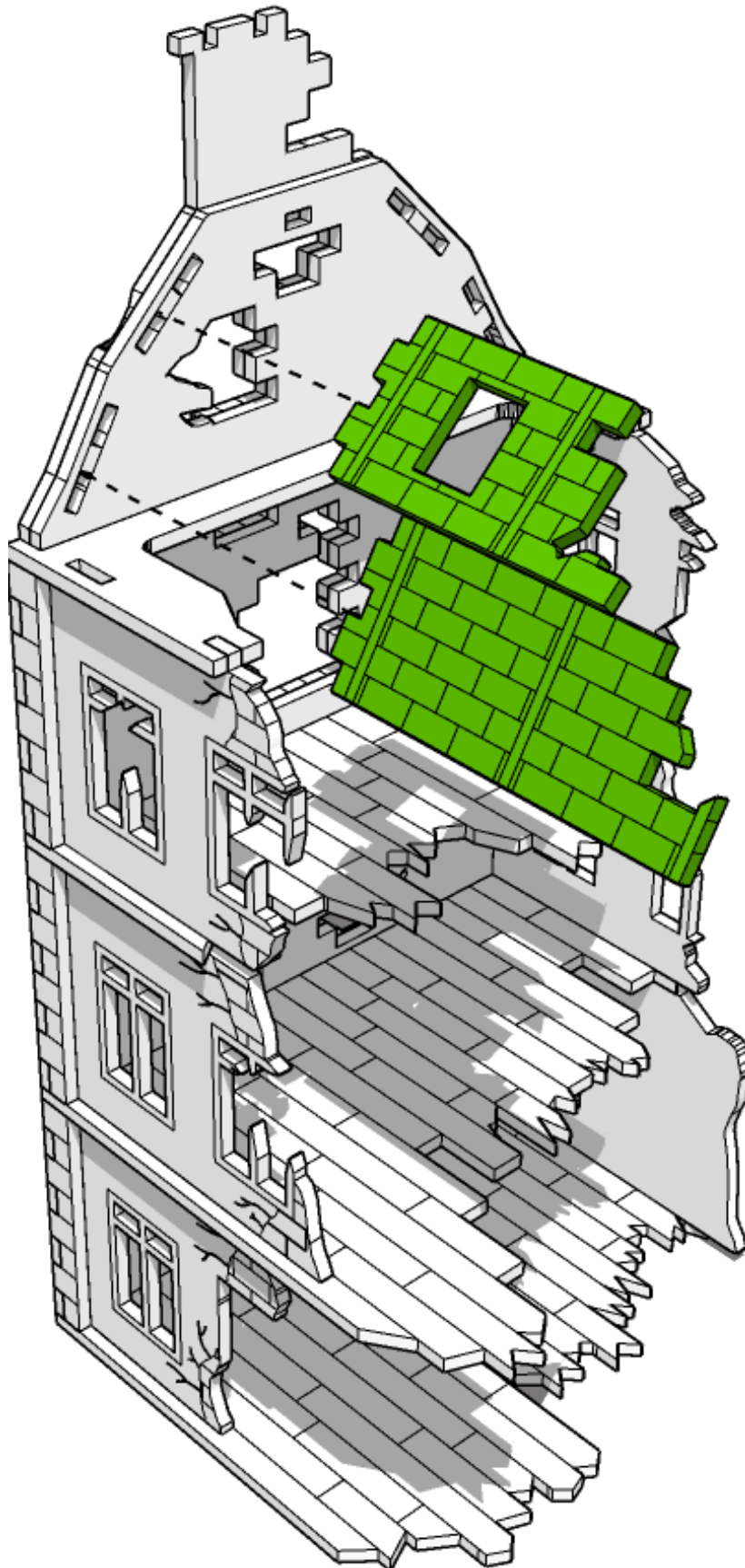



# TABLETOP SCENICS

TTSC-WAR-O83  
City, Corner & Delapidated  
Rowhouse Destroyed

66

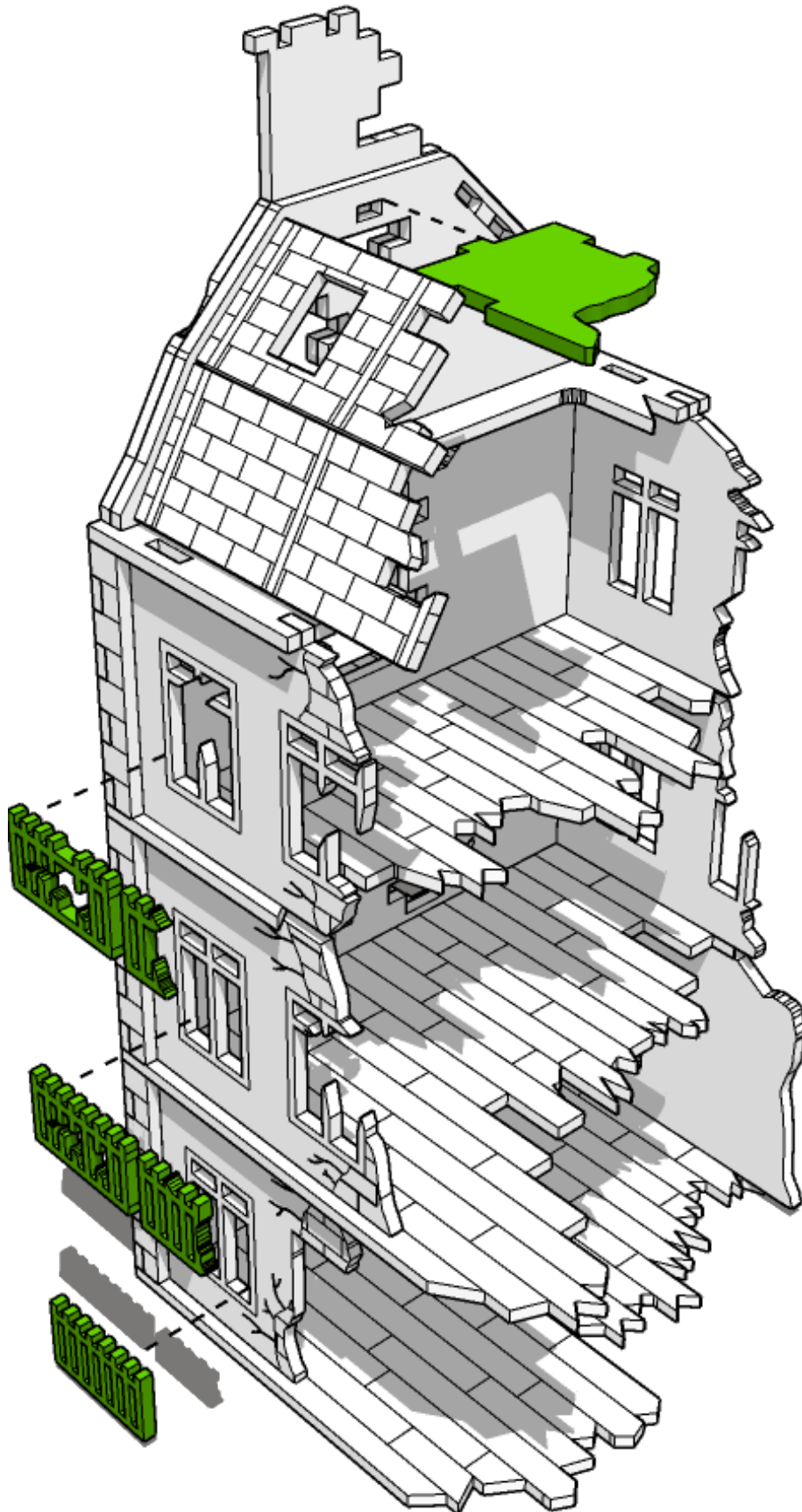



# TABLETOP SCENICS

TTSC-WAR-O83  
City, Corner & Delapidated  
Rowhouse Destroyed

67

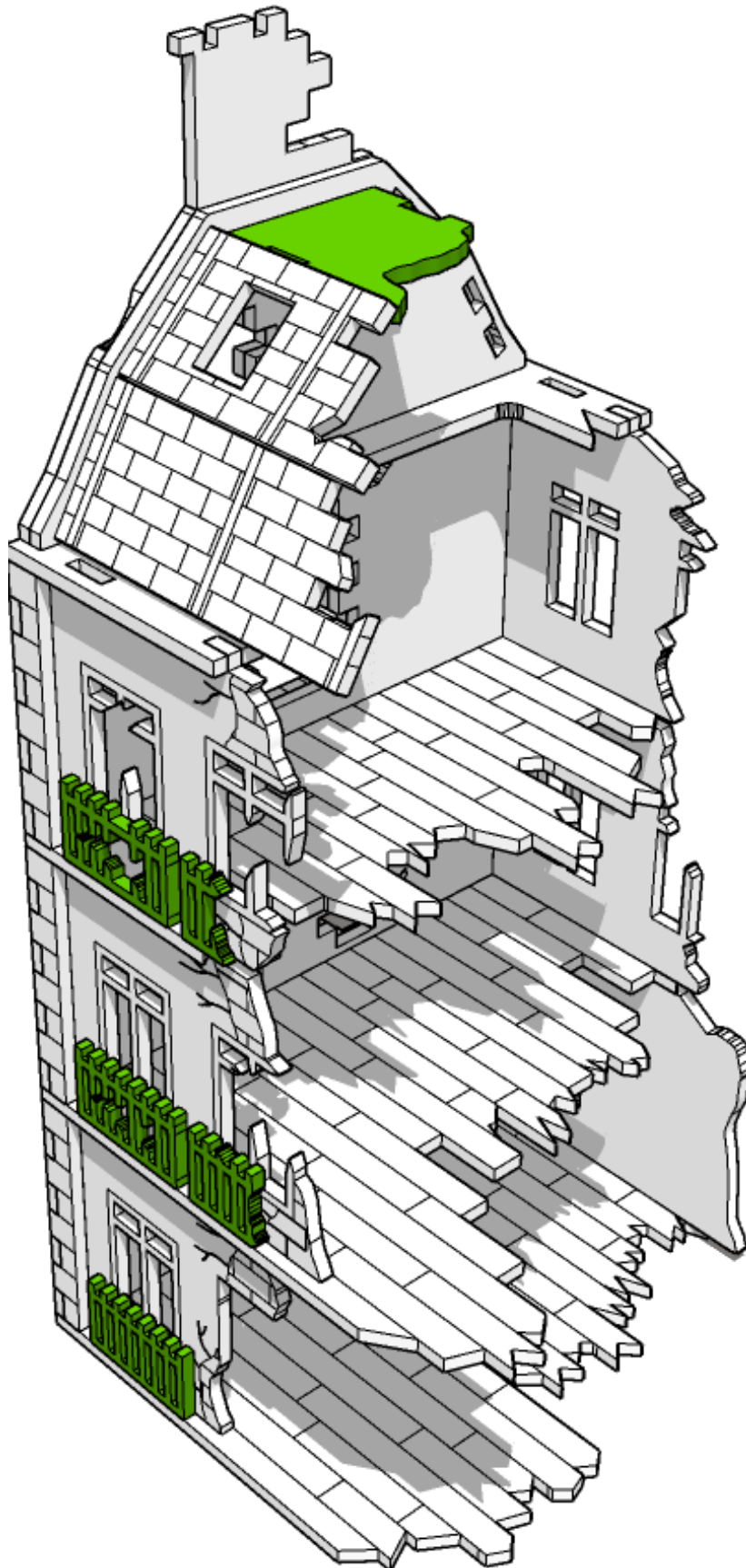



# TABLETOP SCENICS

TTSC-WAR-O83  
City, Corner & Delapidated  
Rowhouse Destroyed

68

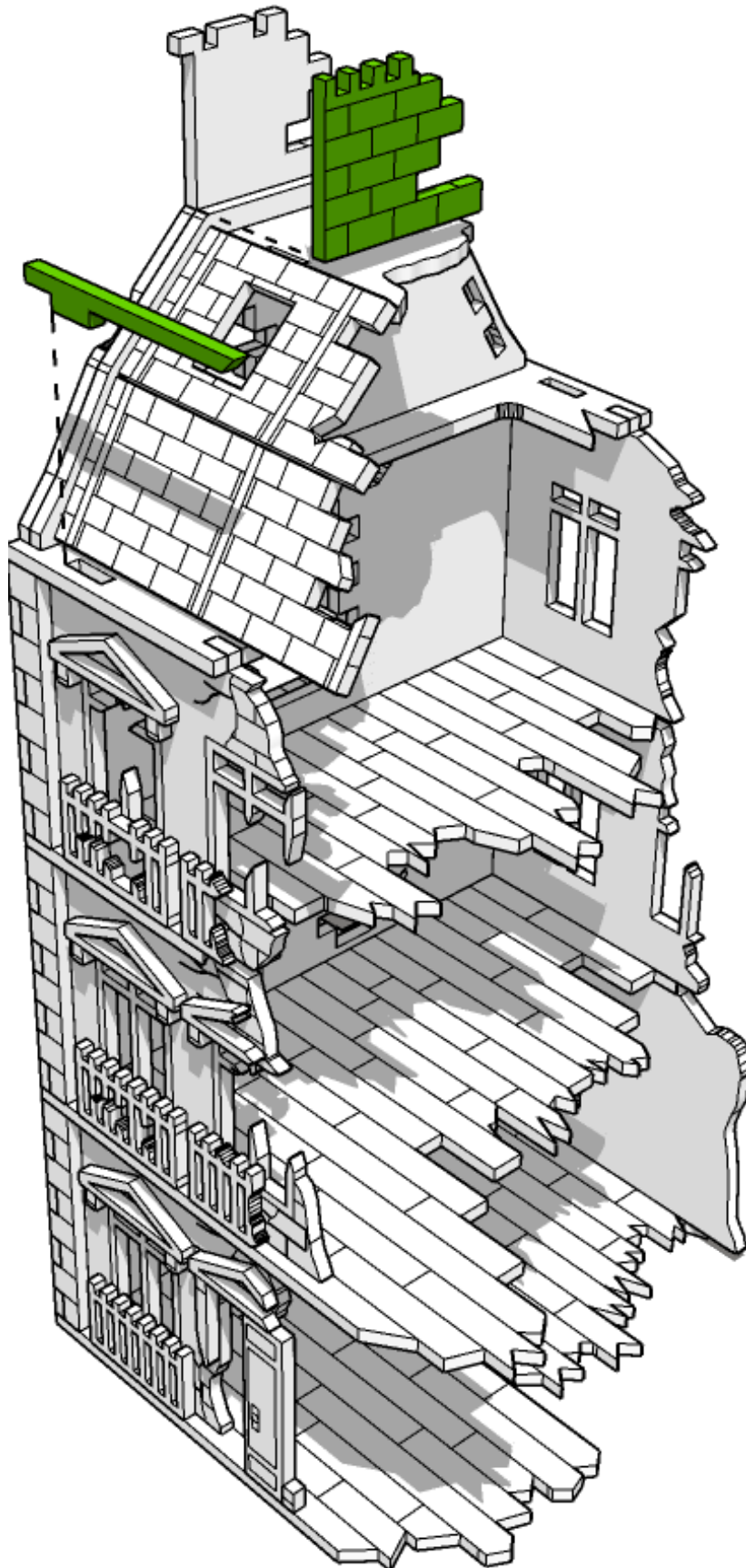



# TABLETOP SCENICS

**TTSC-WAR-O83**  
**City, Corner & Delapidated**  
**Rowhouse Destroyed**

**69**

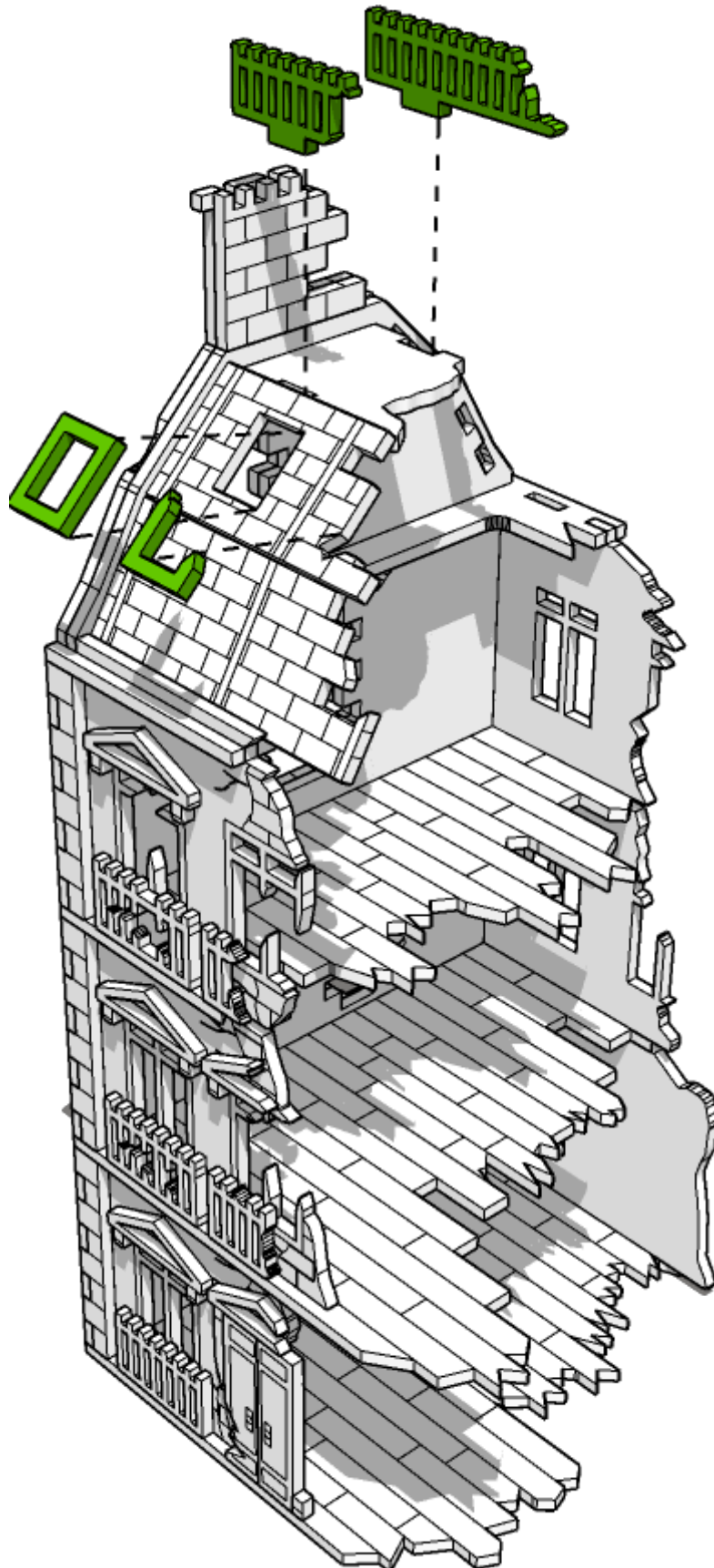



# TABLETOP SCENICS

70

TTSC-WAR-083  
City, Corner & Delapidated  
Rowhouse Destroyed

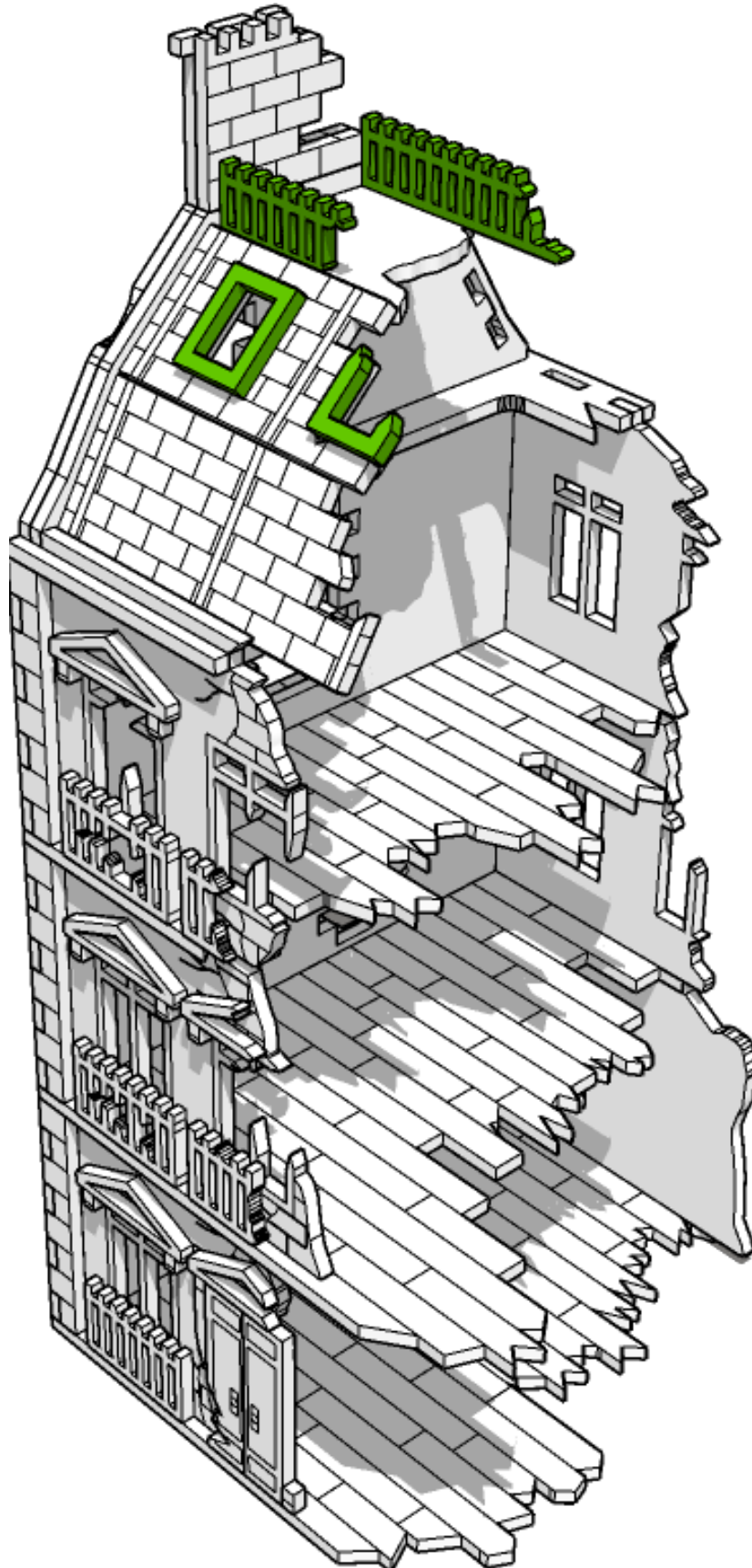



# TABLETOP SCENICS

TTSC-WAR-O83  
City, Corner & Delapidated  
Rowhouse Destroyed

71

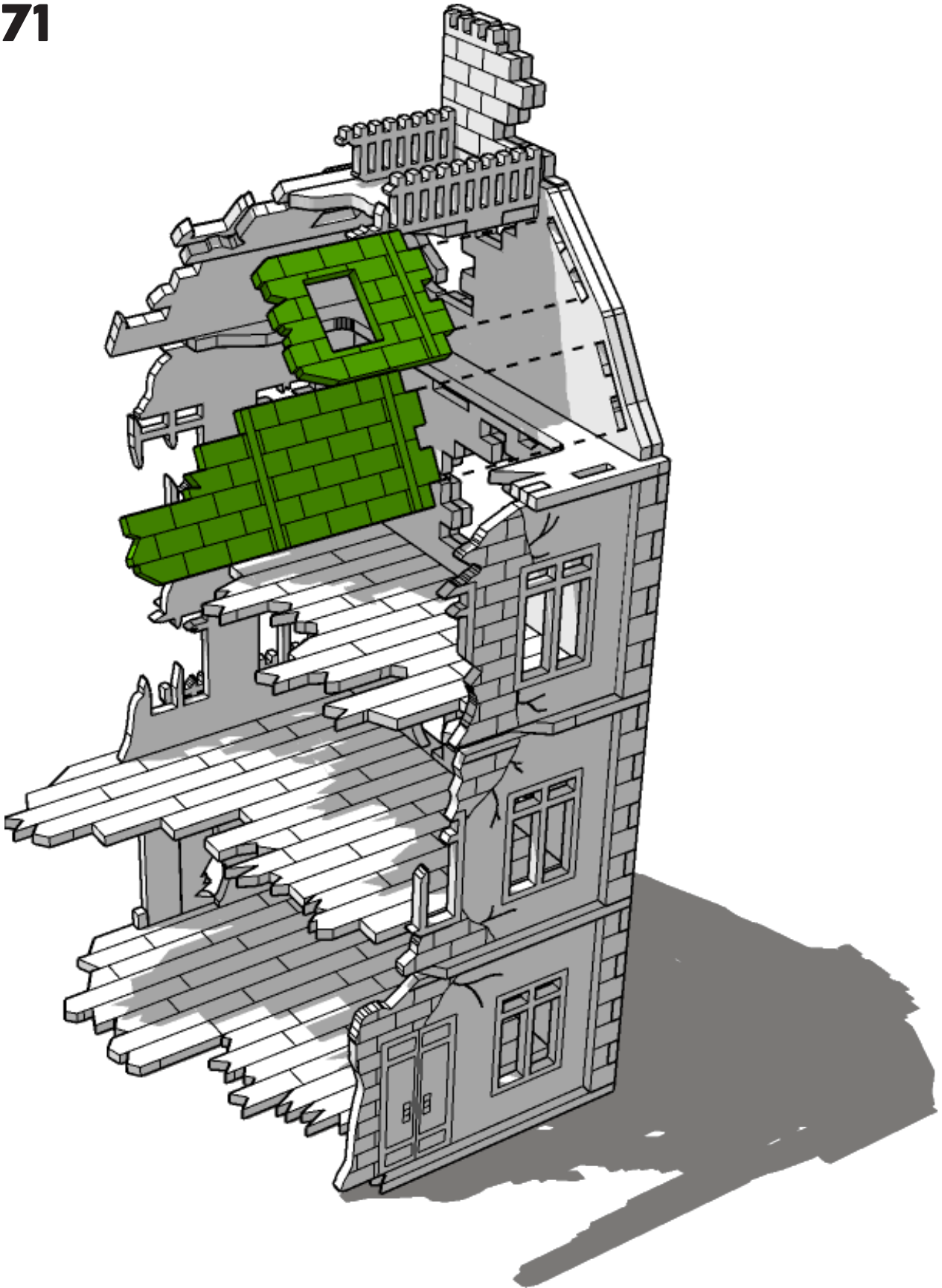





# TABLETOP SCENICS

TTSC-WAR-O83  
City, Corner & Delapidated  
Rowhouse Destroyed

72

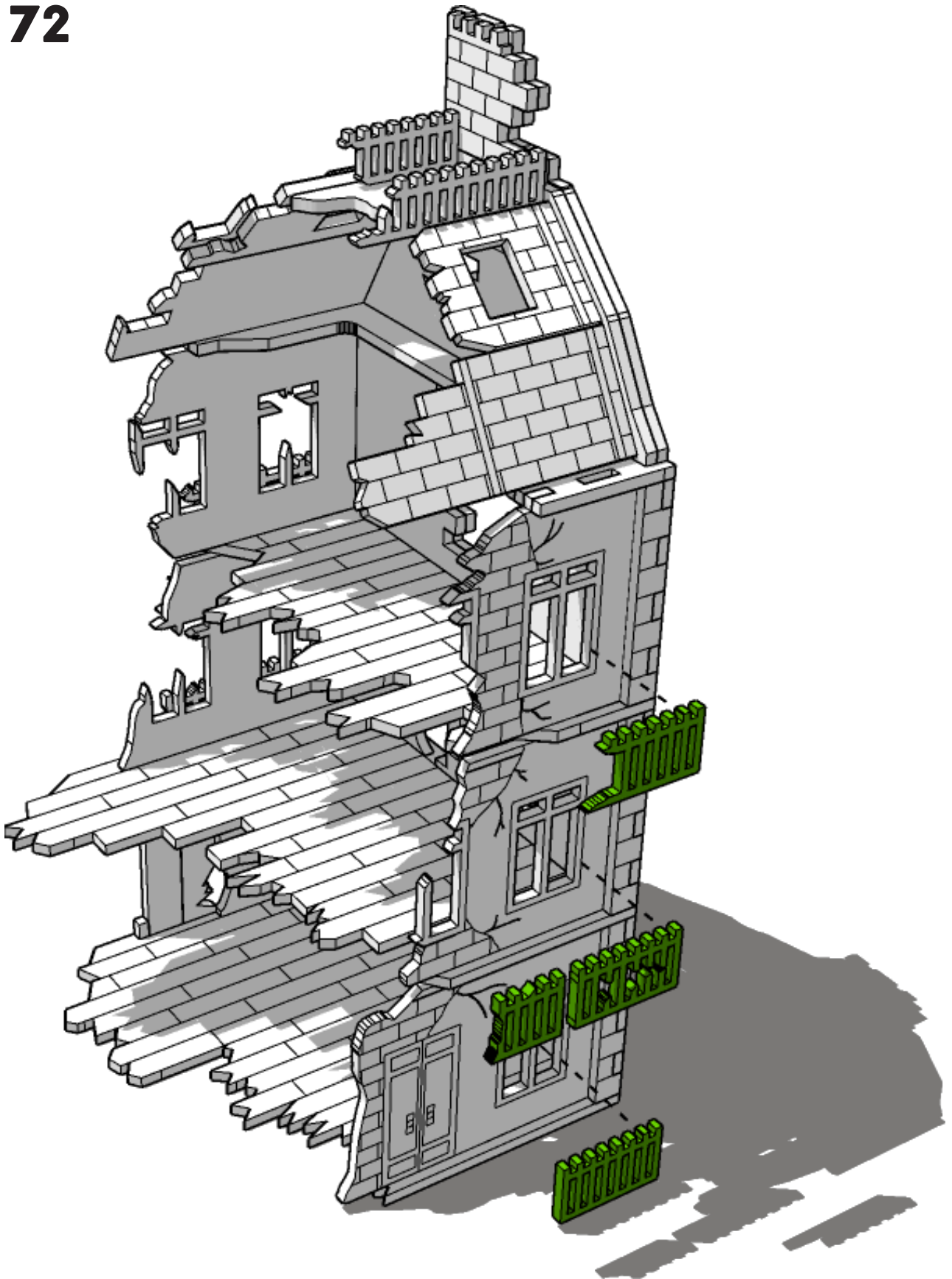



# TABLETOP SCENICS

TTSC-WAR-O83  
City, Corner & Delapidated  
Rowhouse Destroyed

73

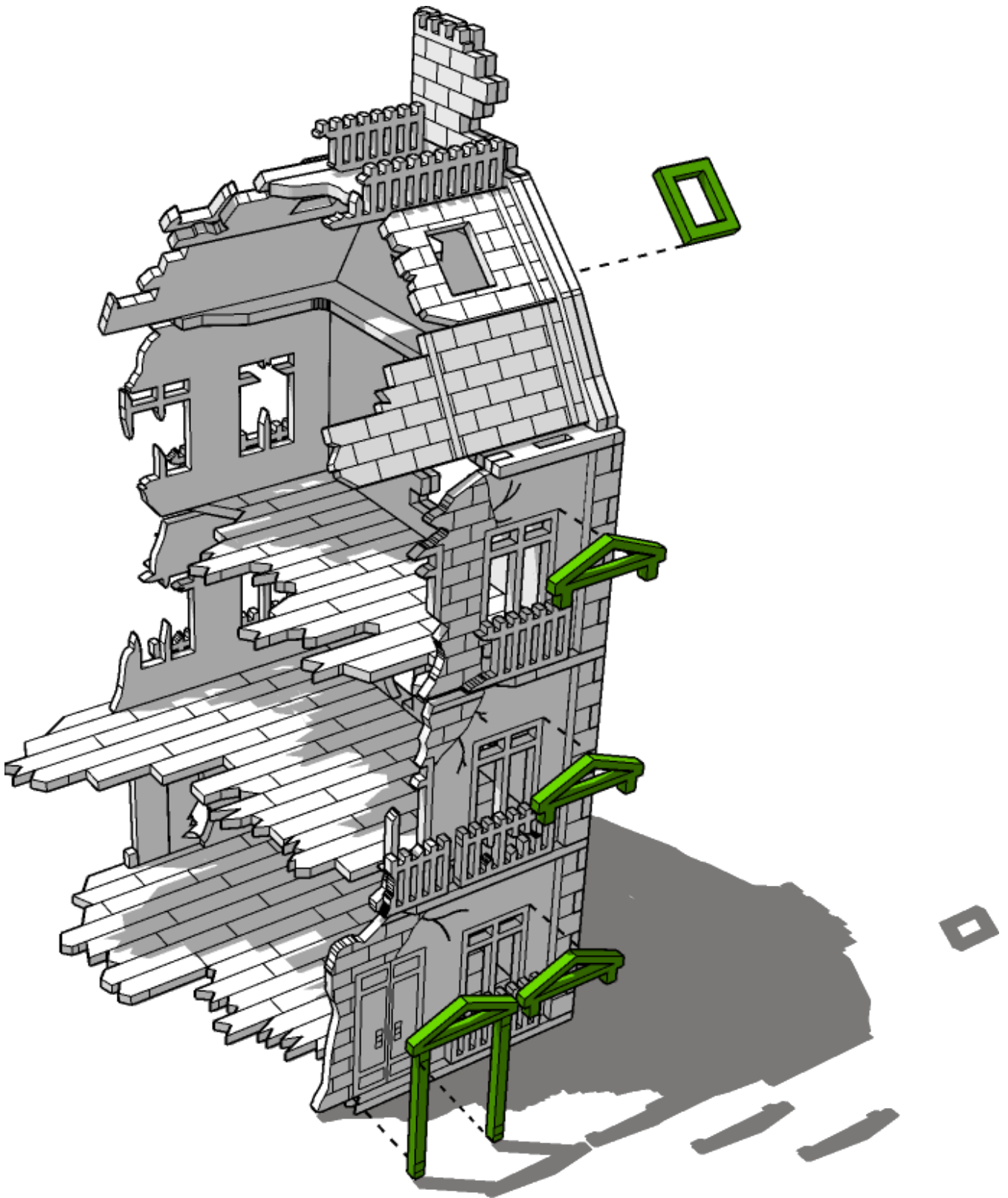



# TABLETOP SCENICS

TTSC-WAR-O83  
City, Corner & Delapidated  
Rowhouse Destroyed

74

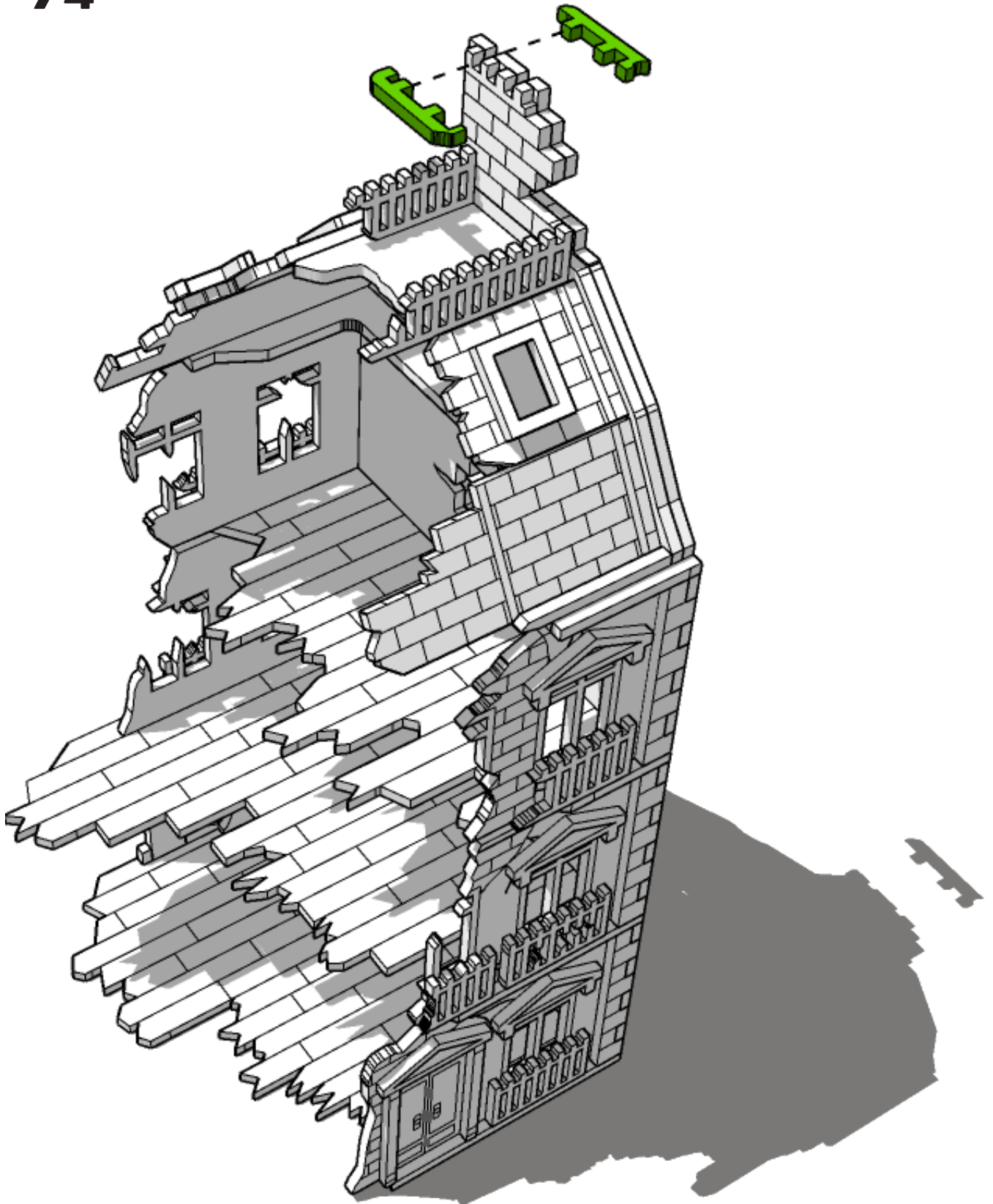



# TABLETOP SCENICS

**TTSC-WAR-O83**  
**City, Corner & Delapidated**  
**Rowhouse Destroyed**

**75**

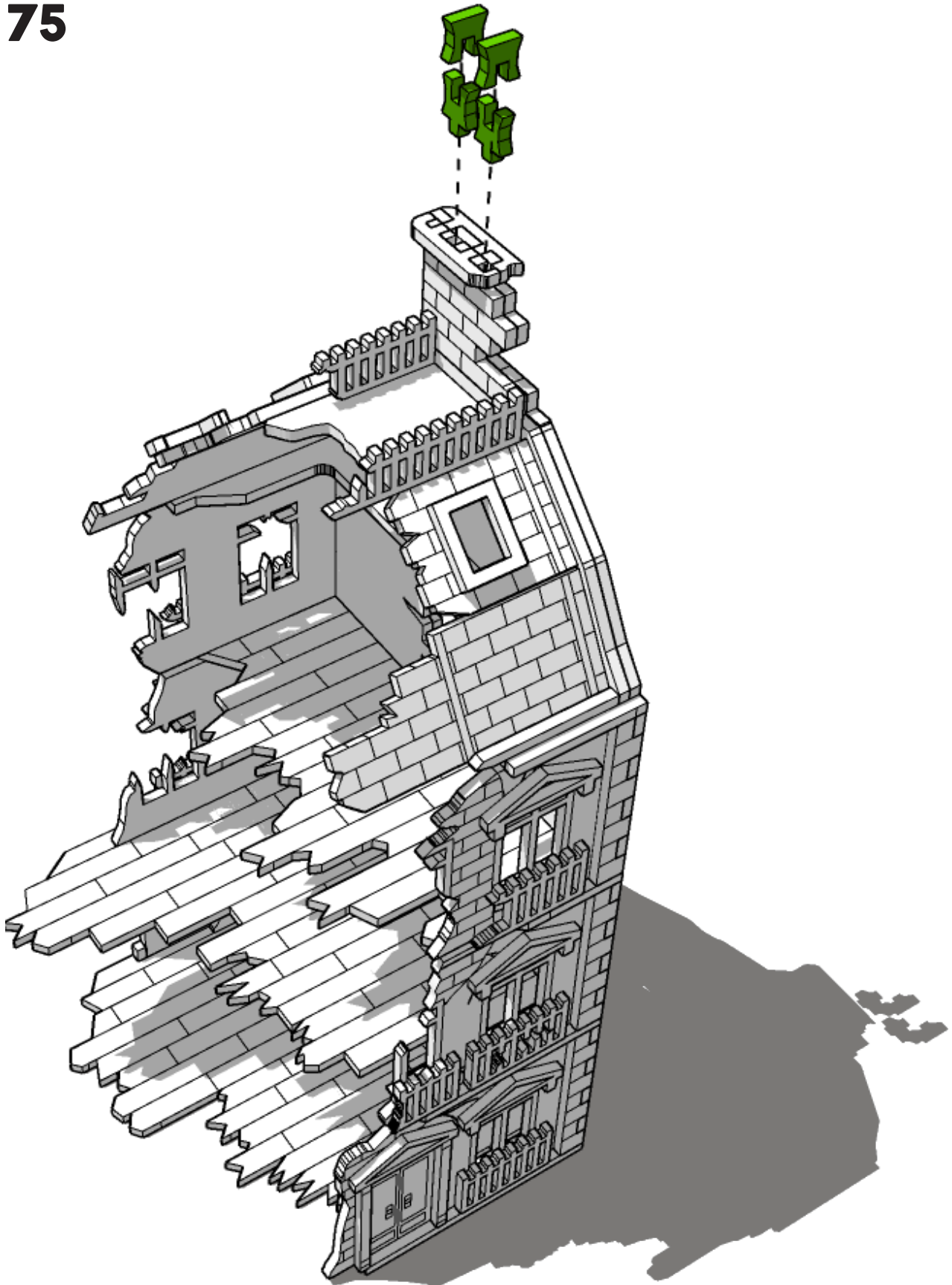



# TABLETOP SCENICS

TTSC-WAR-O83  
City, Corner & Delapidated  
Rowhouse Destroyed

76

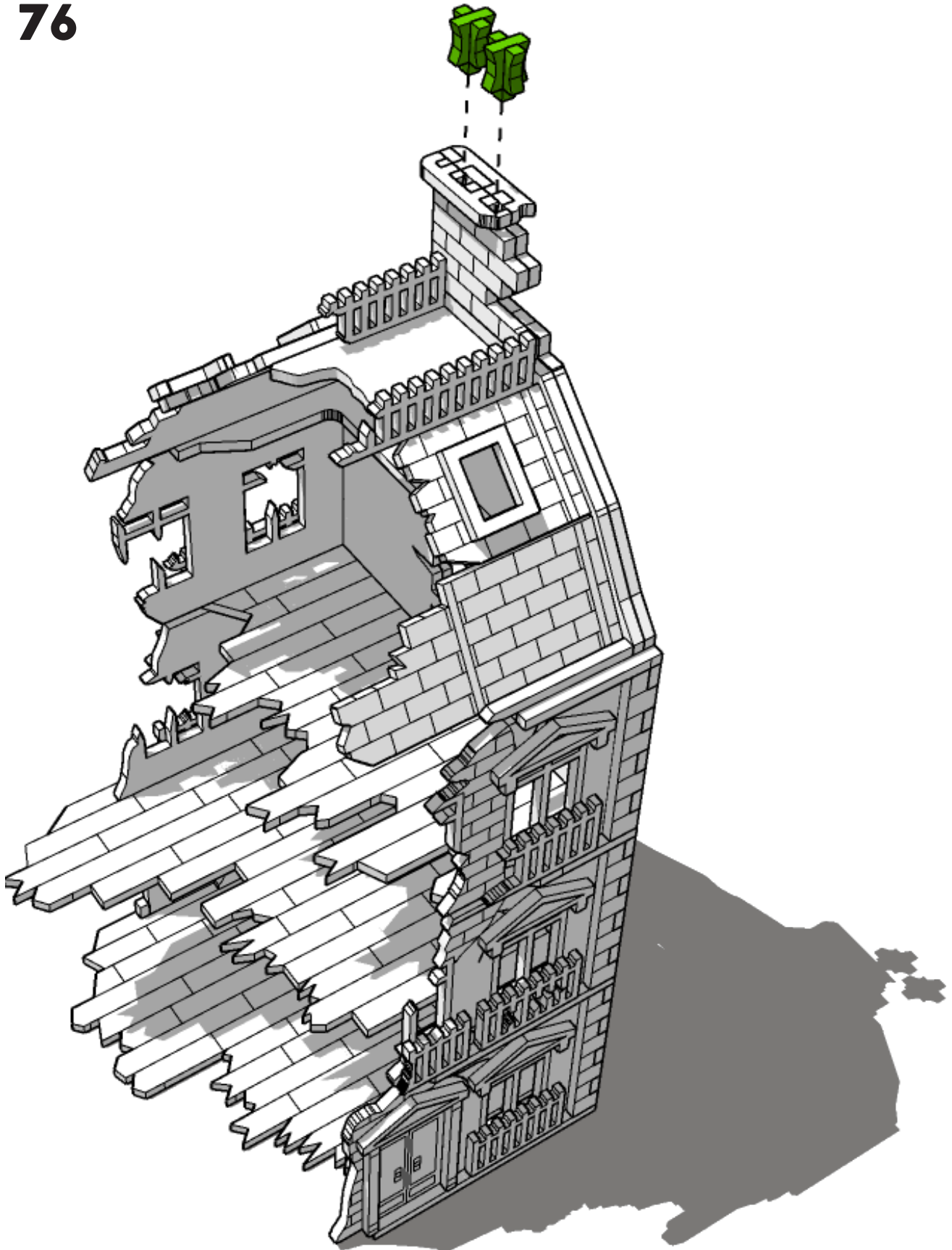



# TABLETOP SCENICS

**TTSC-WAR-O83**  
**City, Corner & Delapidated**  
**Rowhouse Destroyed**

**77**

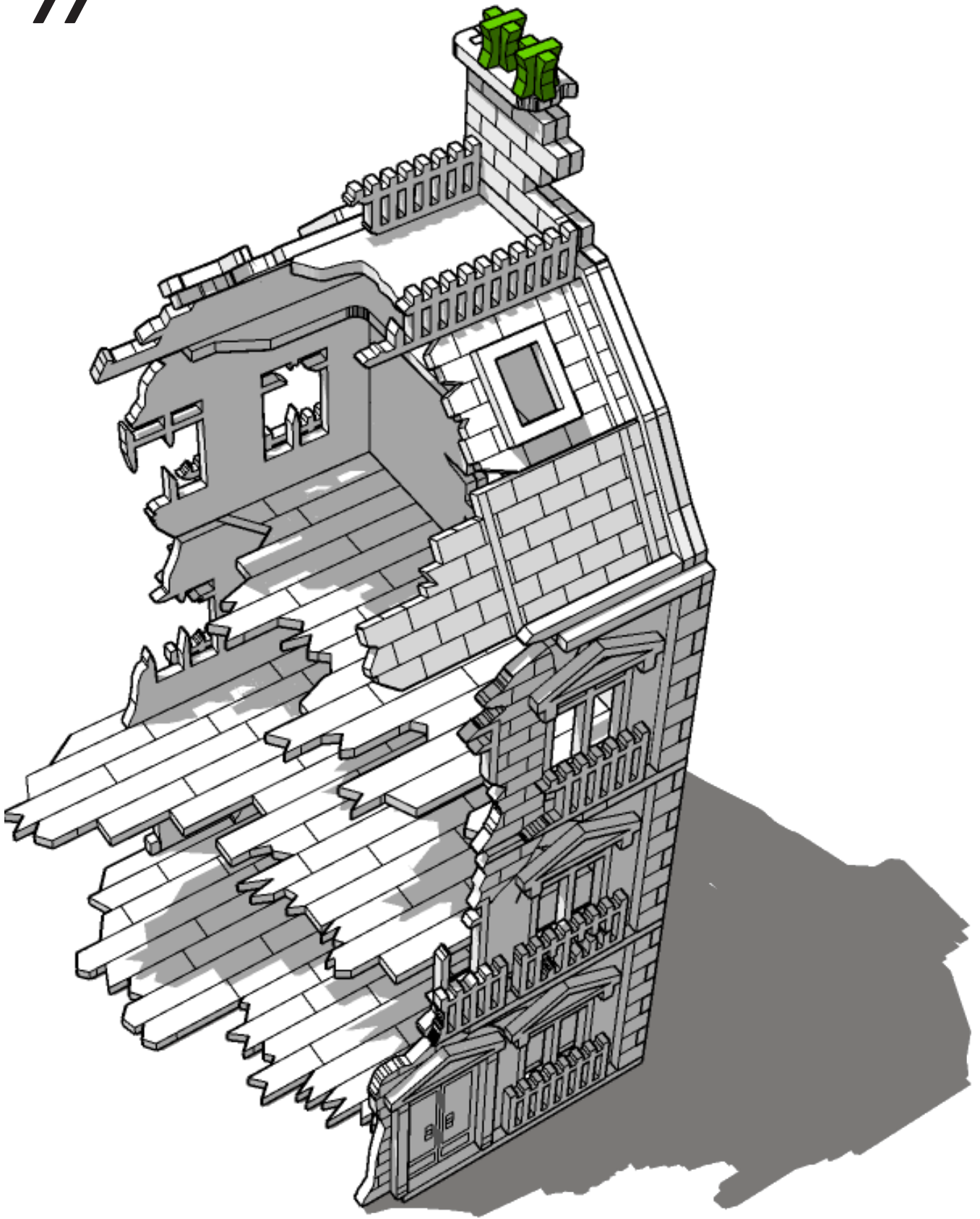



TABLETOP  
**SCENICS**

**TTSC-WAR-O83**  
**City, Corner & Delapidated**  
**Rowhouse Destroyed**

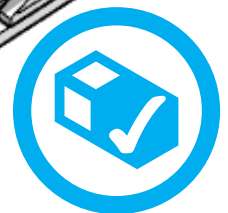
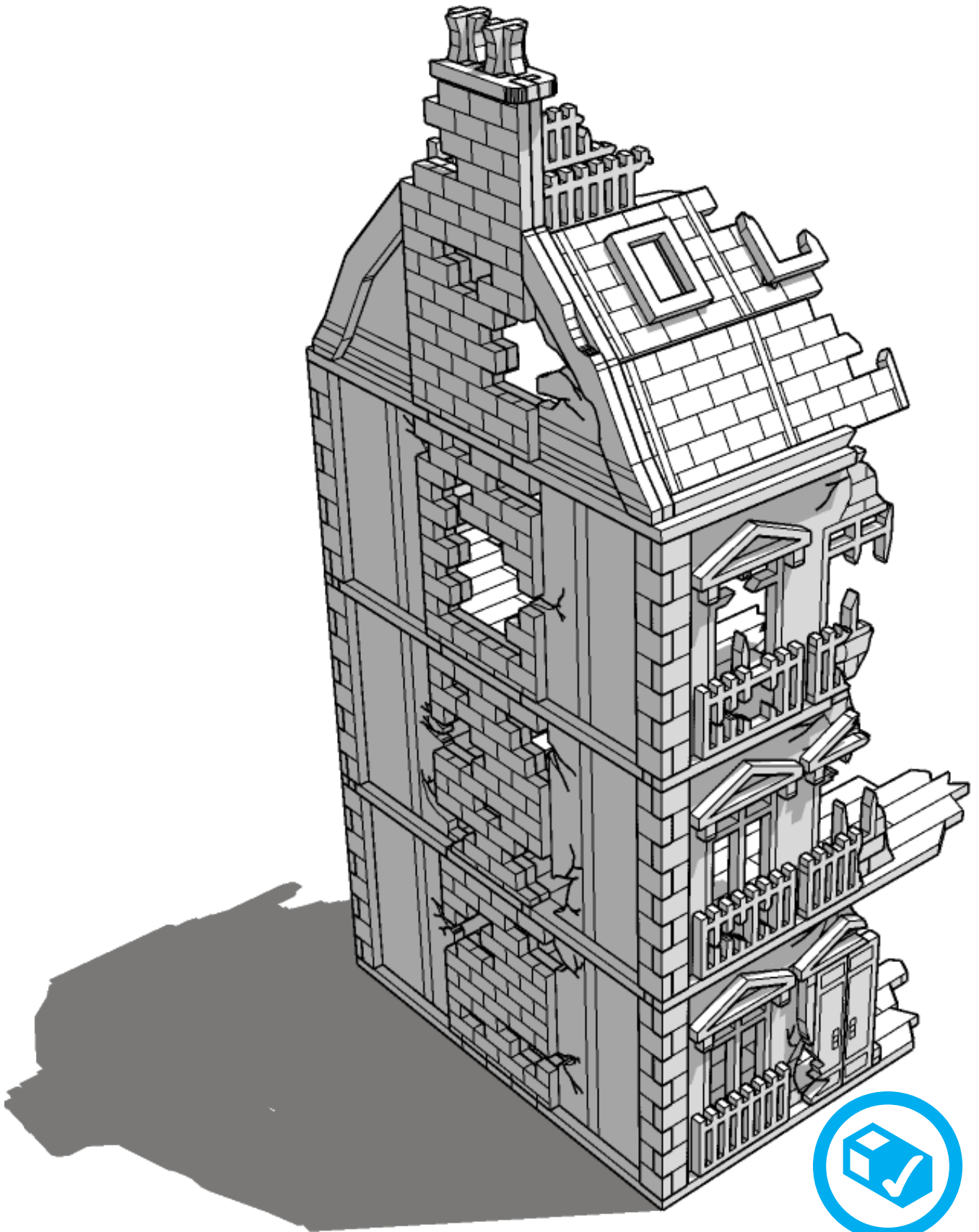

 **TTCOMBAT**



# TABLETOP SCENICS

79

TTSC-WAR-O83  
City, Corner & Delapidated  
Rowhouse Destroyed

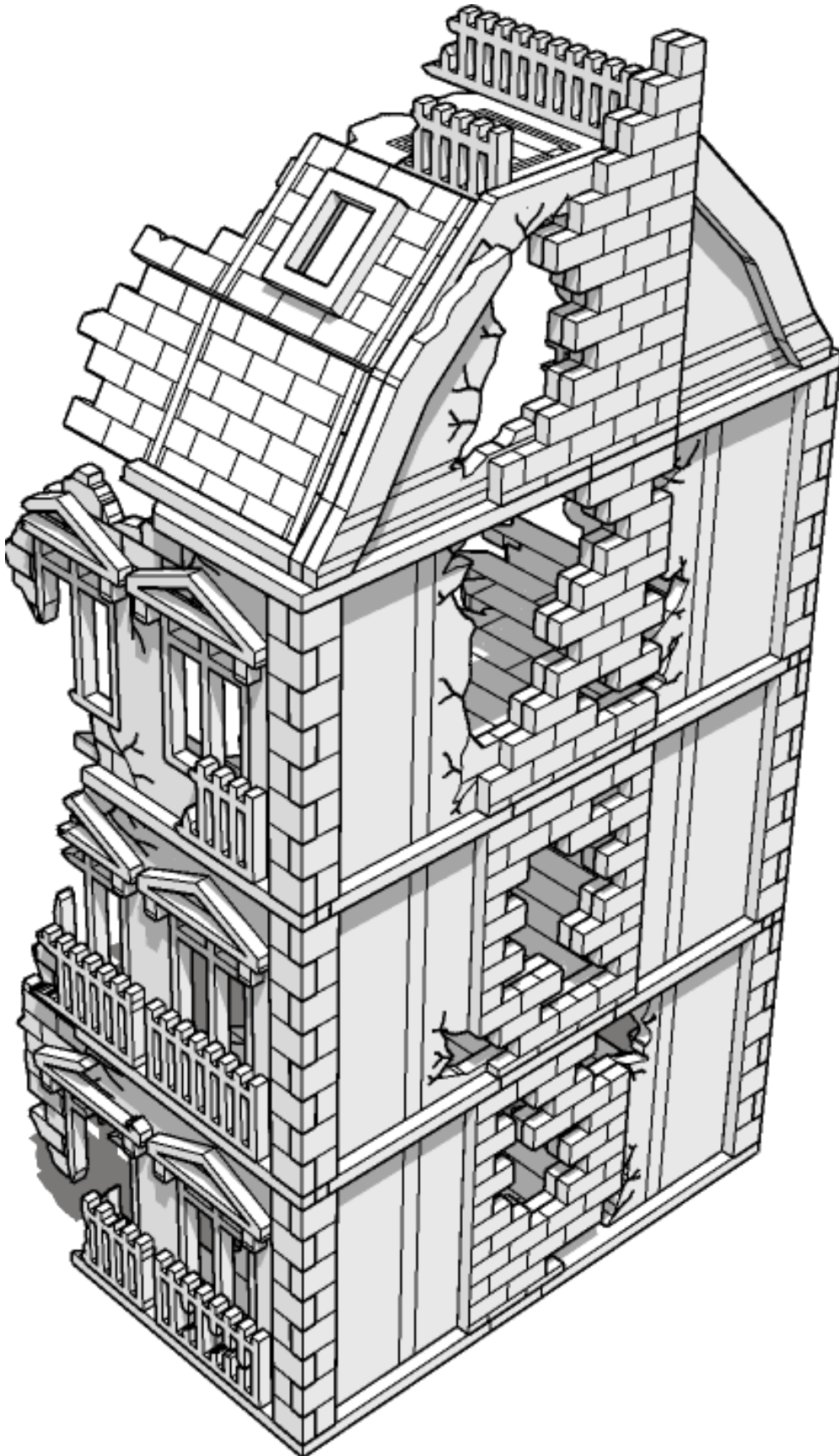





# TABLETOP SCENICS

80

TTSC-WAR-O83  
City, Corner & Delapidated  
Rowhouse Destroyed

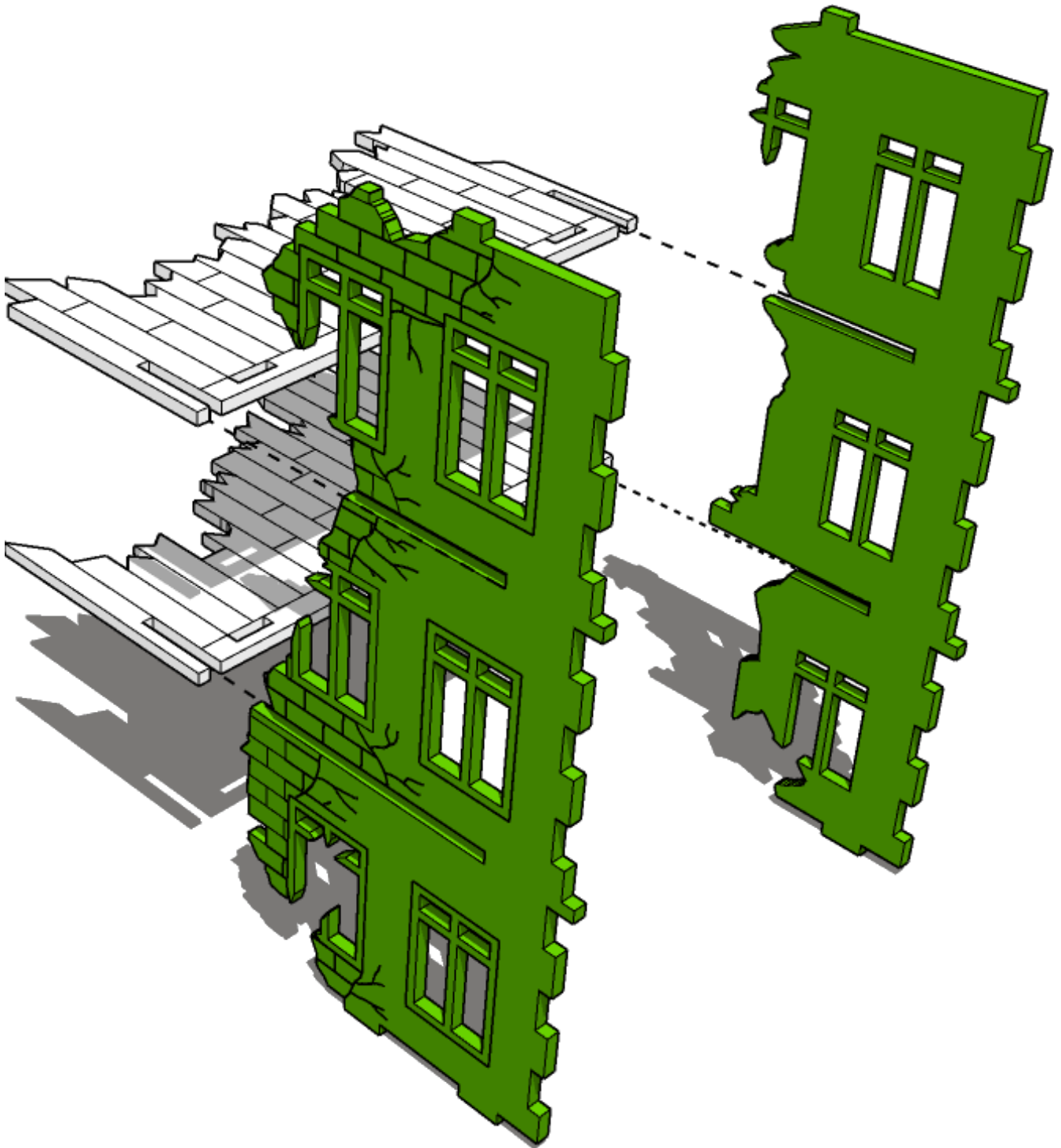



# TABLETOP SCENICS

**TTSC-WAR-O83**  
**City, Corner & Delapidated**  
**Rowhouse Destroyed**

**81**

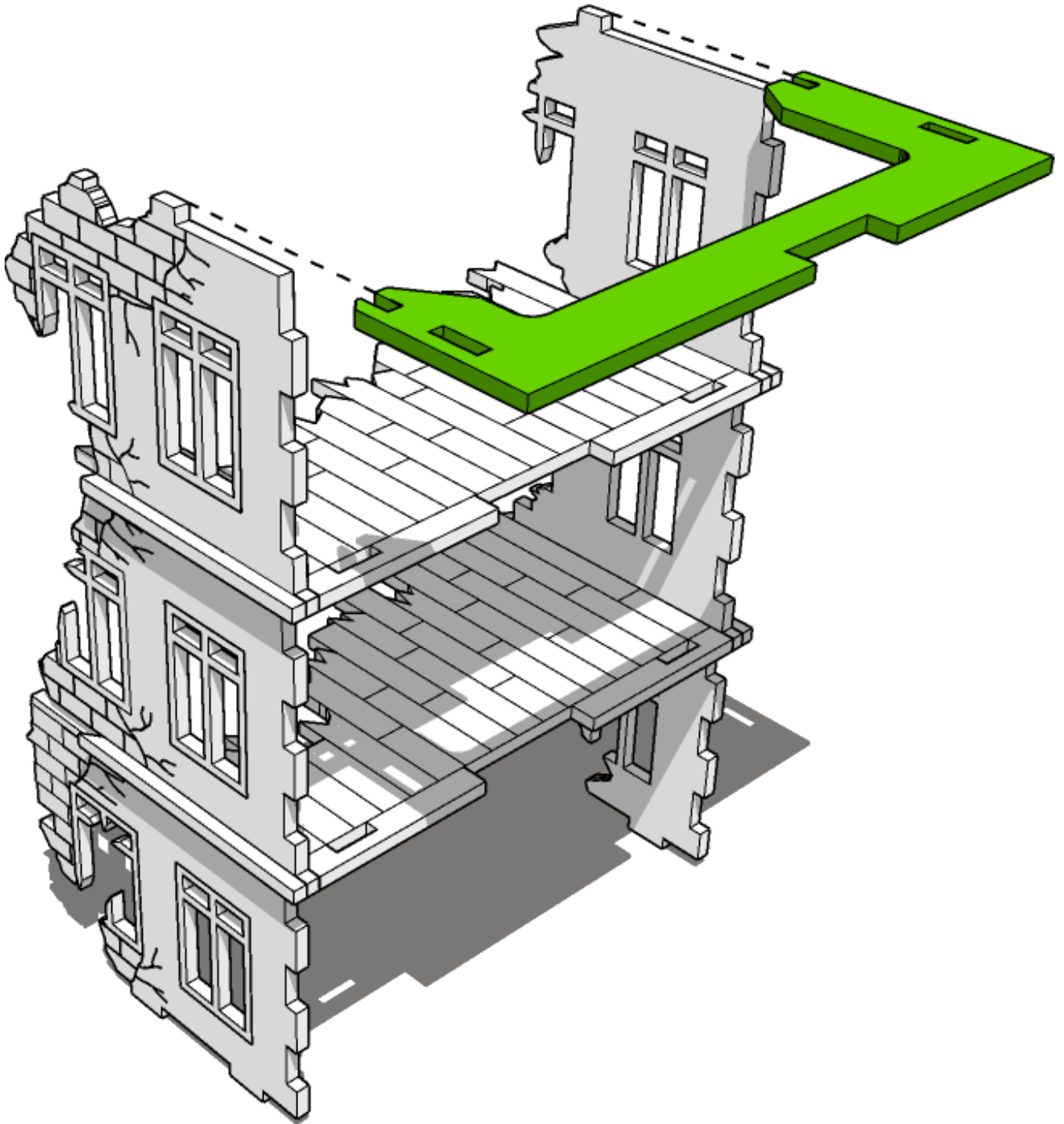



# TABLETOP SCENICS

TTSC-WAR-O83  
City, Corner & Delapidated  
Rowhouse Destroyed

82

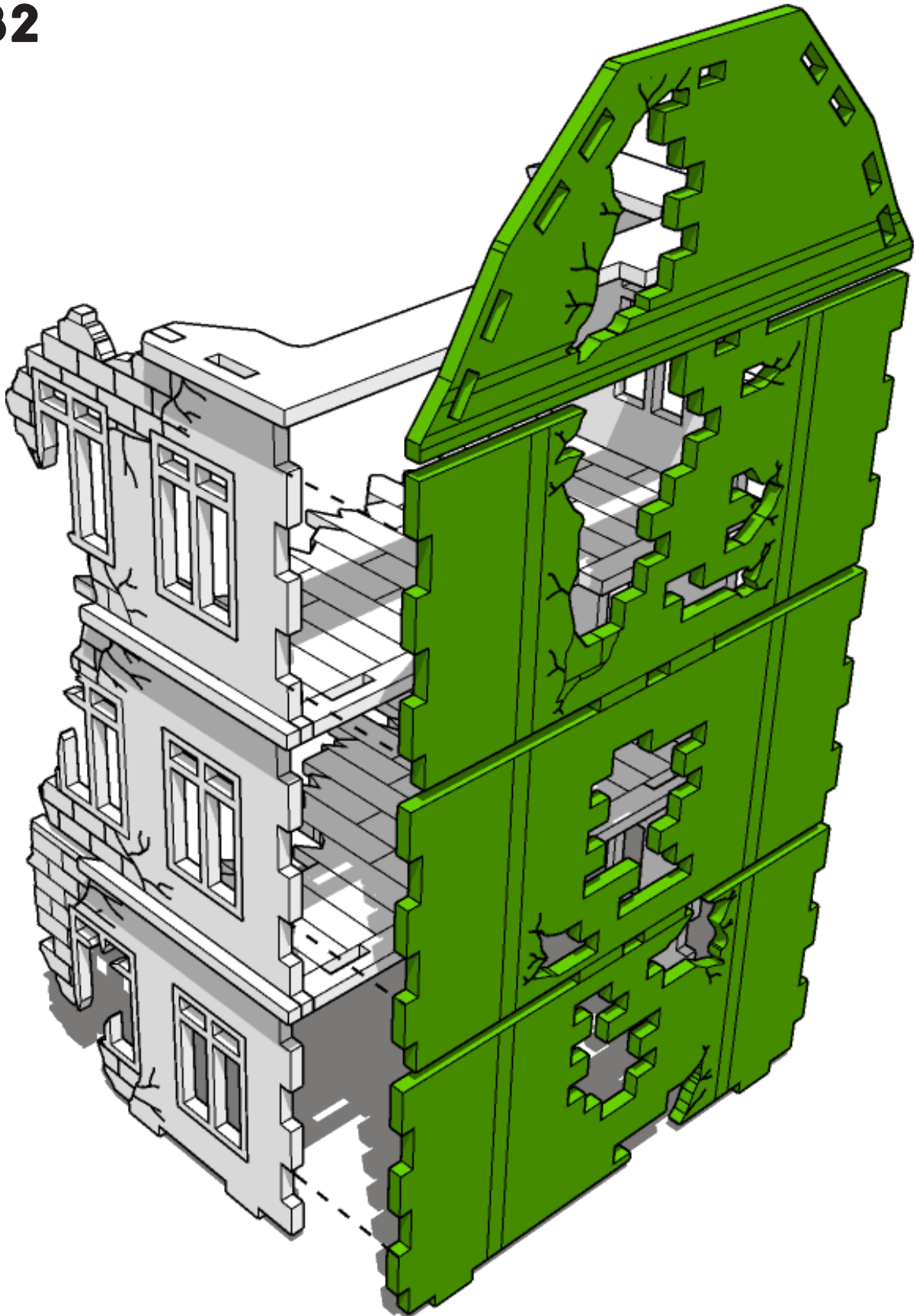



# TABLETOP SCENICS

TTSC-WAR-O83  
City, Corner & Delapidated  
Rowhouse Destroyed

83

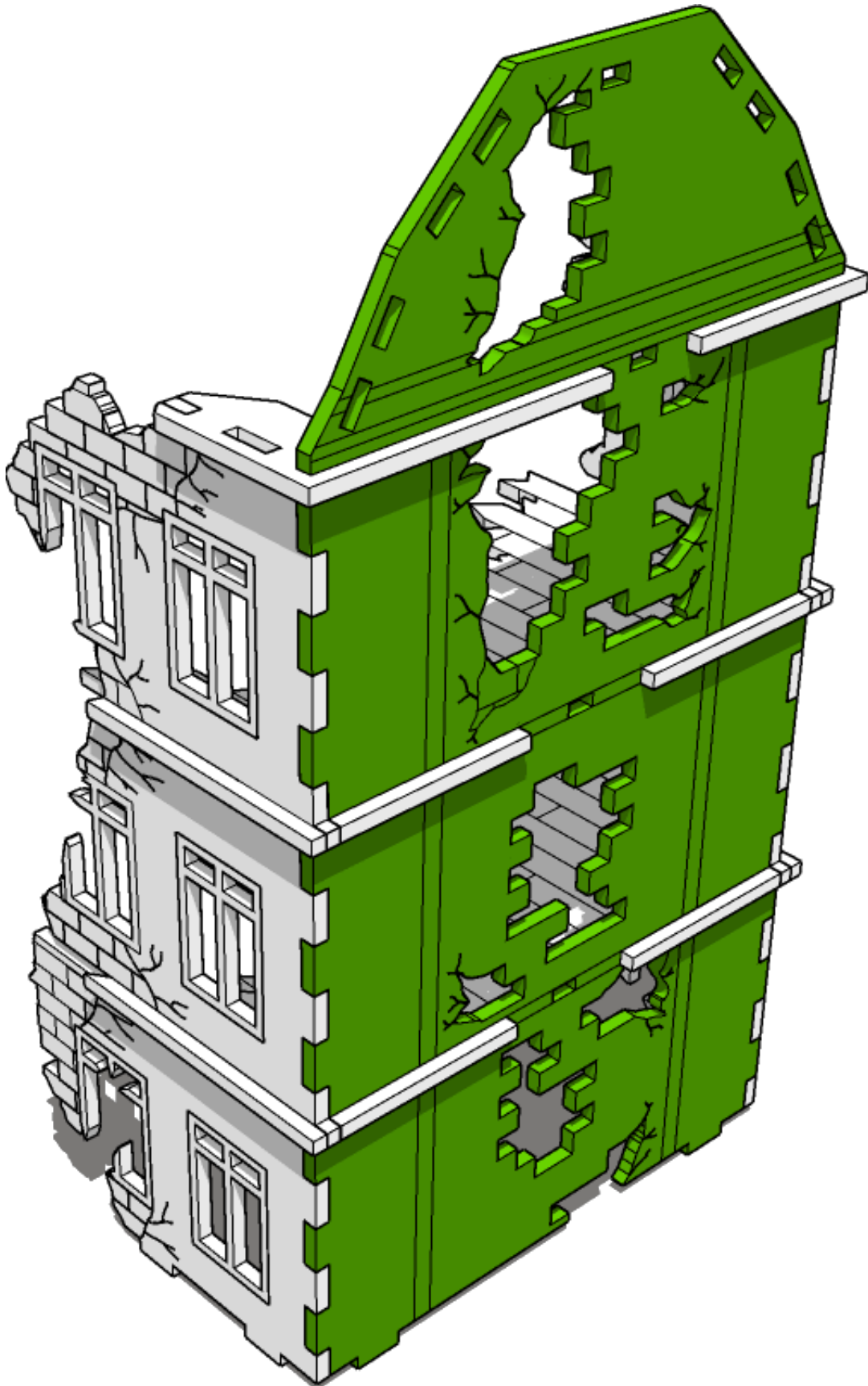



# TABLETOP SCENICS

**TTSC-WAR-O83**  
**City, Corner & Delapidated**  
**Rowhouse Destroyed**

**84**

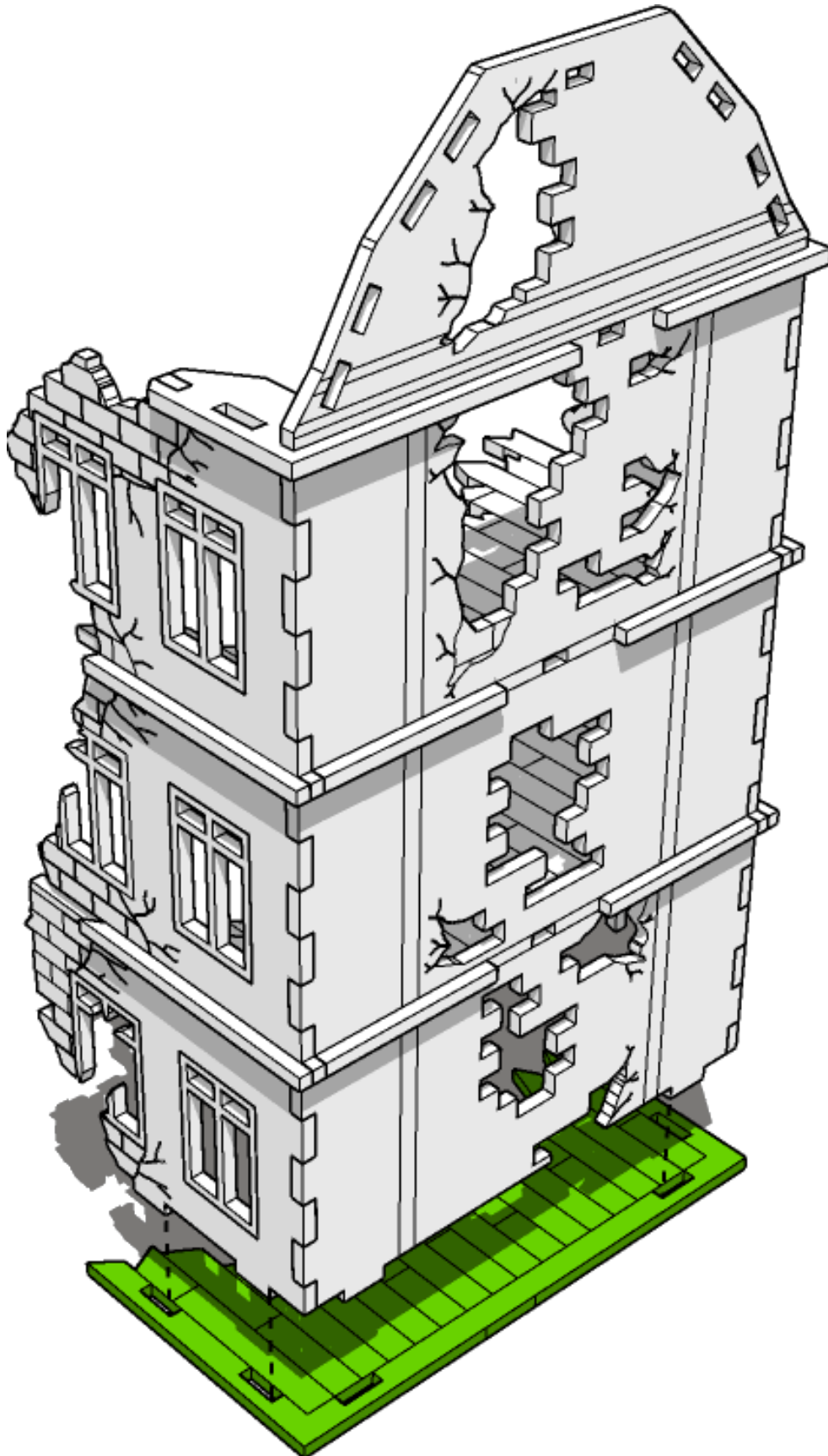



# TABLETOP SCENICS

TTSC-WAR-O83  
City, Corner & Delapidated  
Rowhouse Destroyed

85

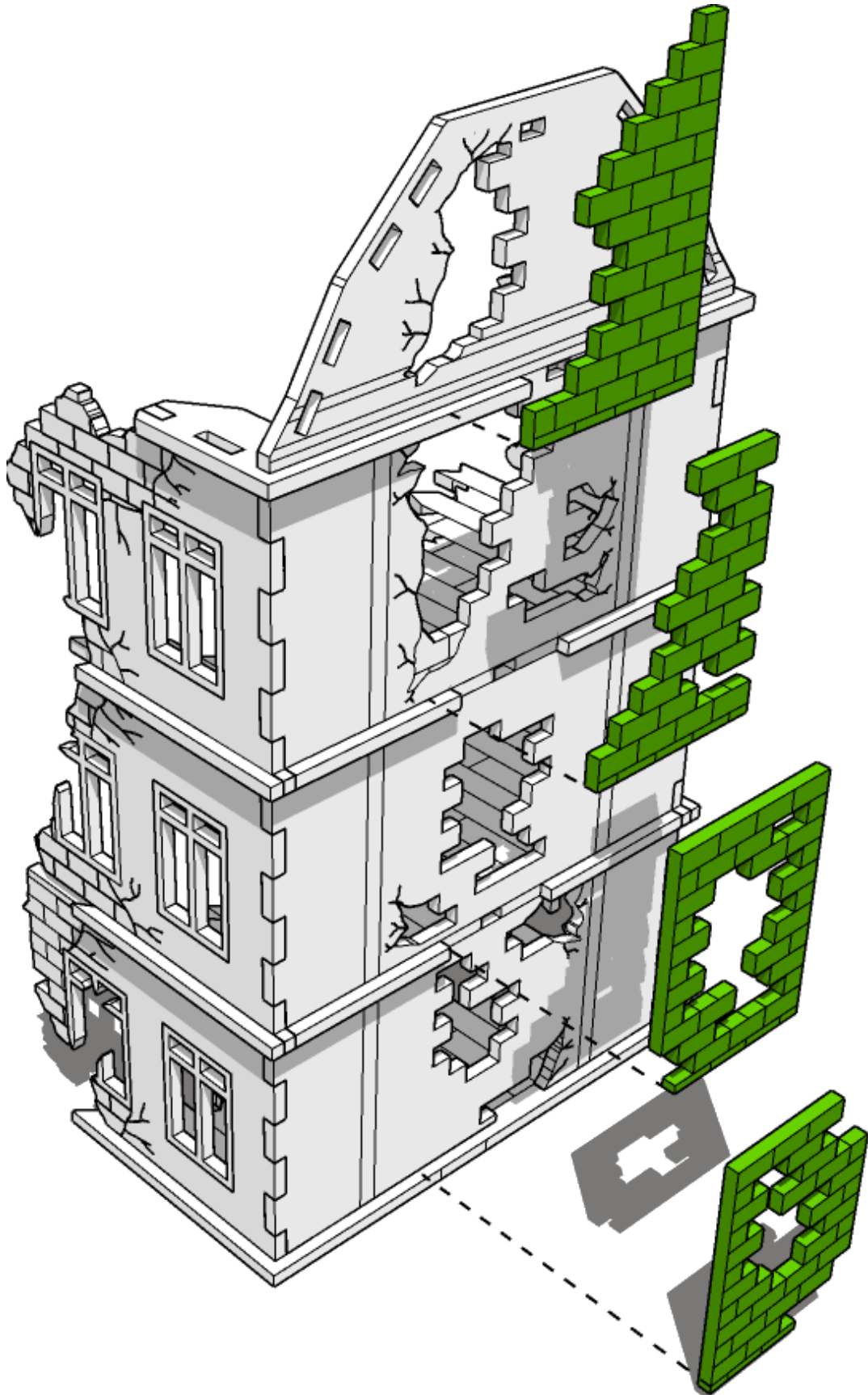



# TABLETOP SCENICS

**TTSC-WAR-O83**  
**City, Corner & Delapidated**  
**Rowhouse Destroyed**

**86**

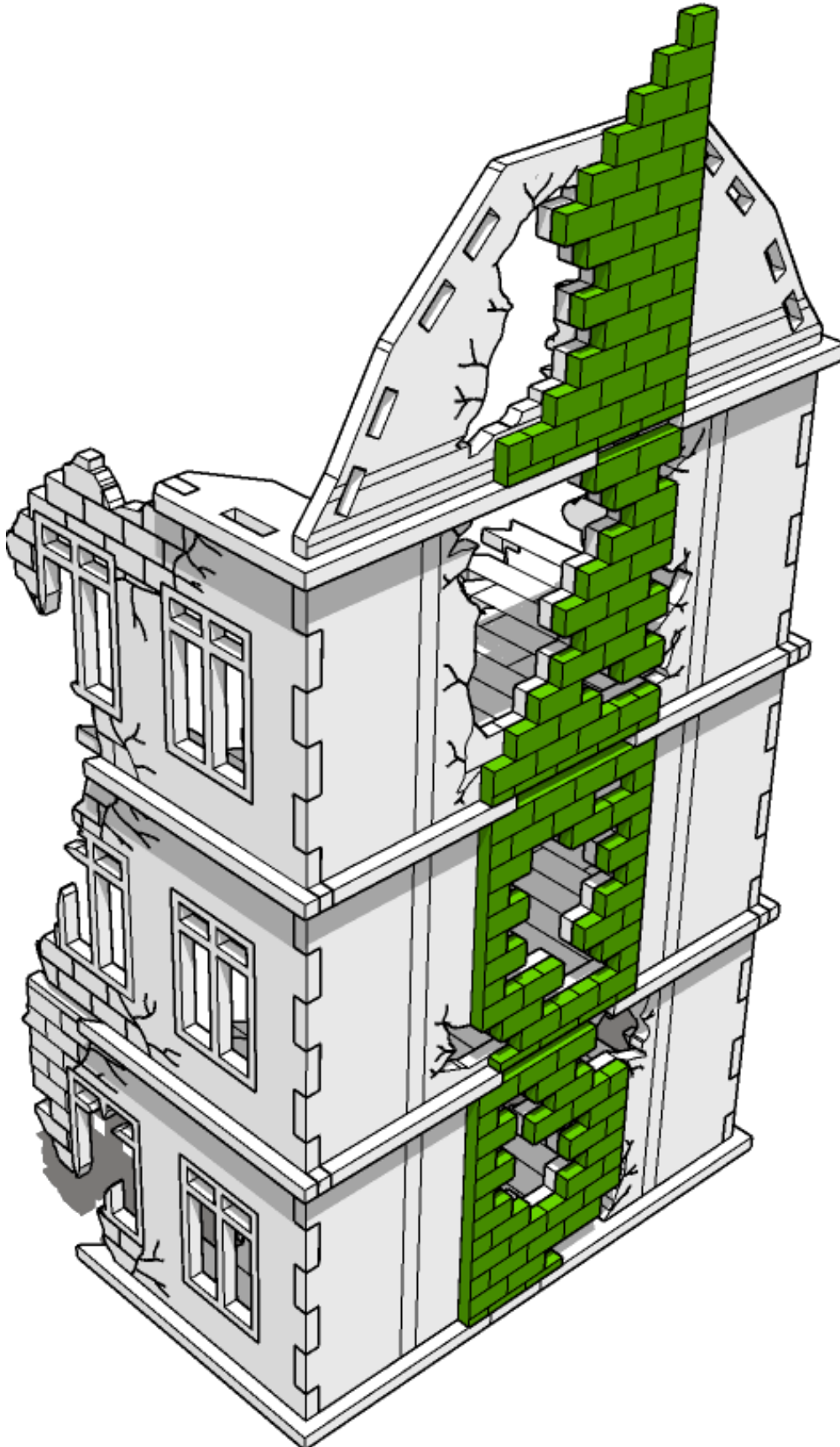



# TABLETOP SCENICS

87

TTSC-WAR-O83  
City, Corner & Delapidated  
Rowhouse Destroyed

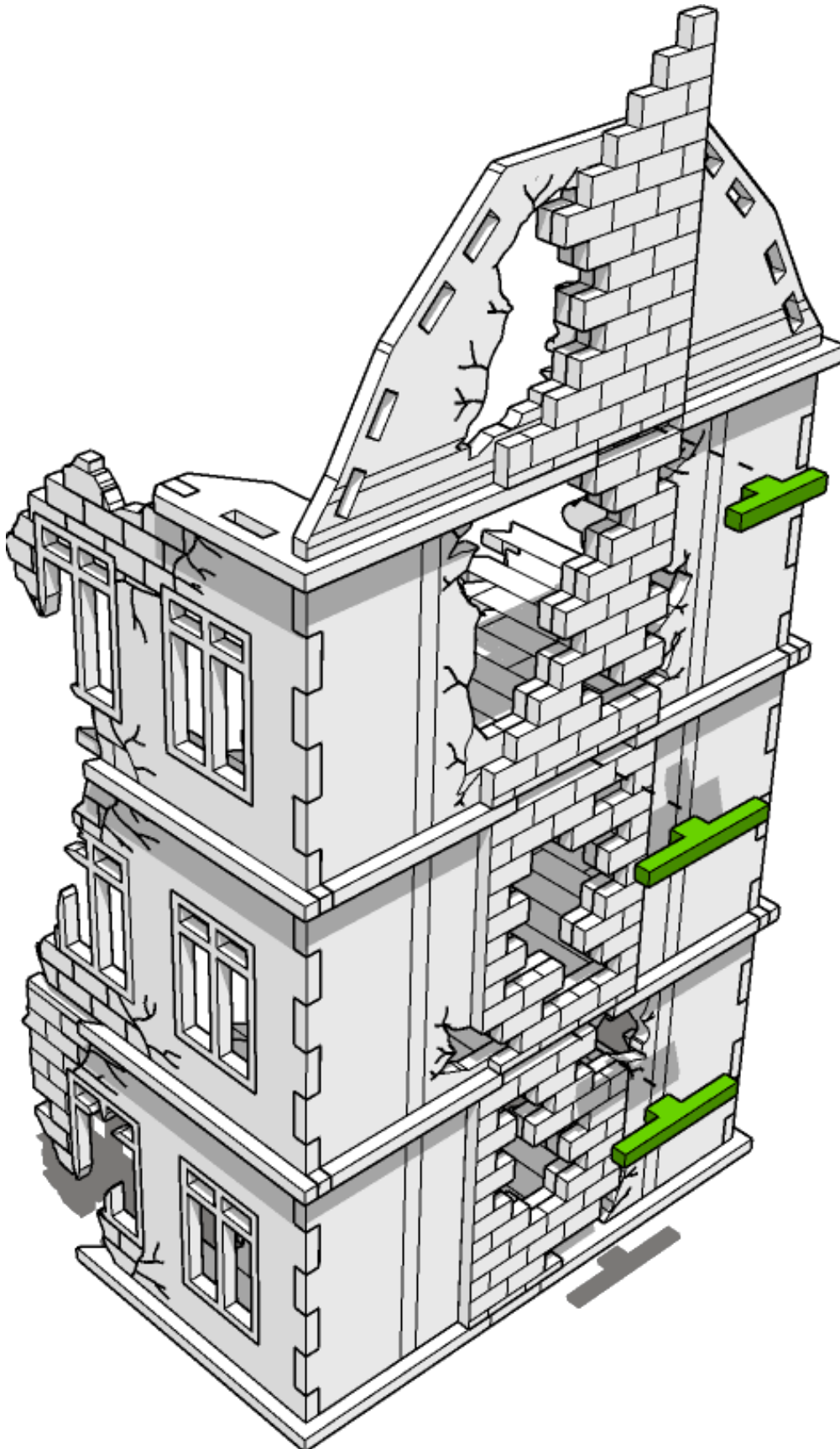





# TABLETOP SCENICS

**TTSC-WAR-O83**  
**City, Corner & Delapidated**  
**Rowhouse Destroyed**

**88**

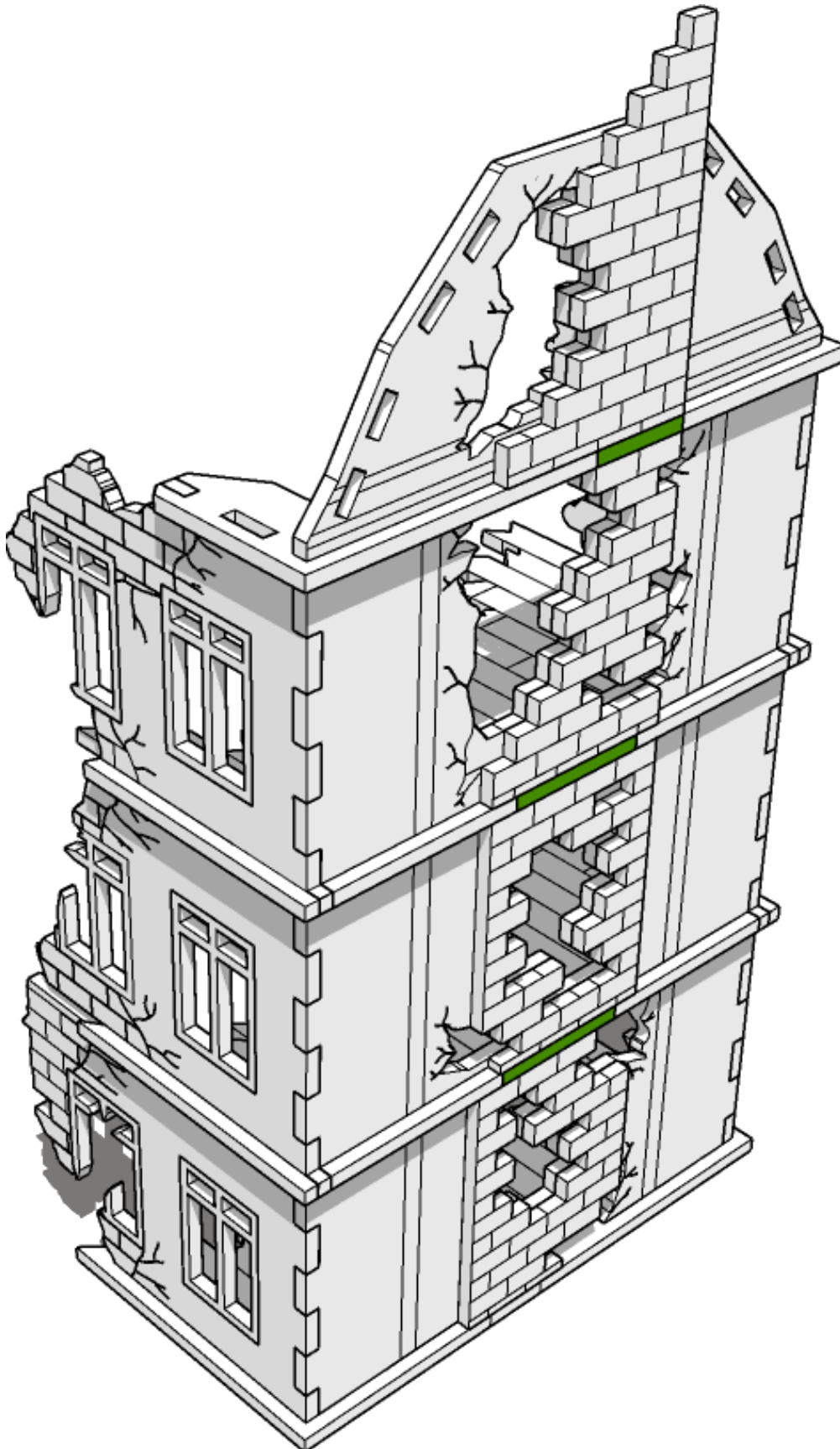



# TABLETOP SCENICS

**TTSC-WAR-O83**  
**City, Corner & Delapidated**  
**Rowhouse Destroyed**

**89**

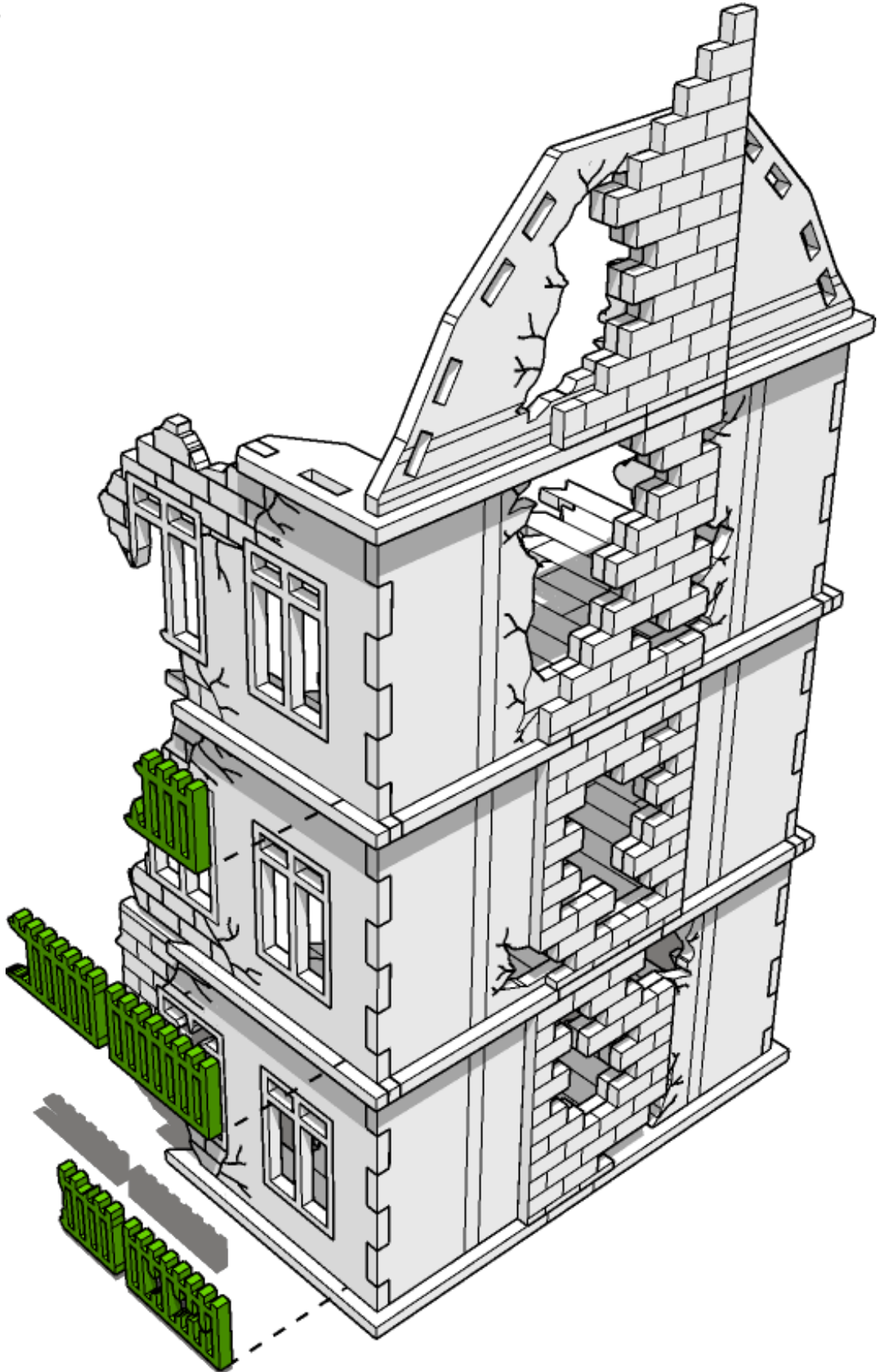



# TABLETOP SCENICS

90

TTSC-WAR-O83  
City, Corner & Delapidated  
Rowhouse Destroyed

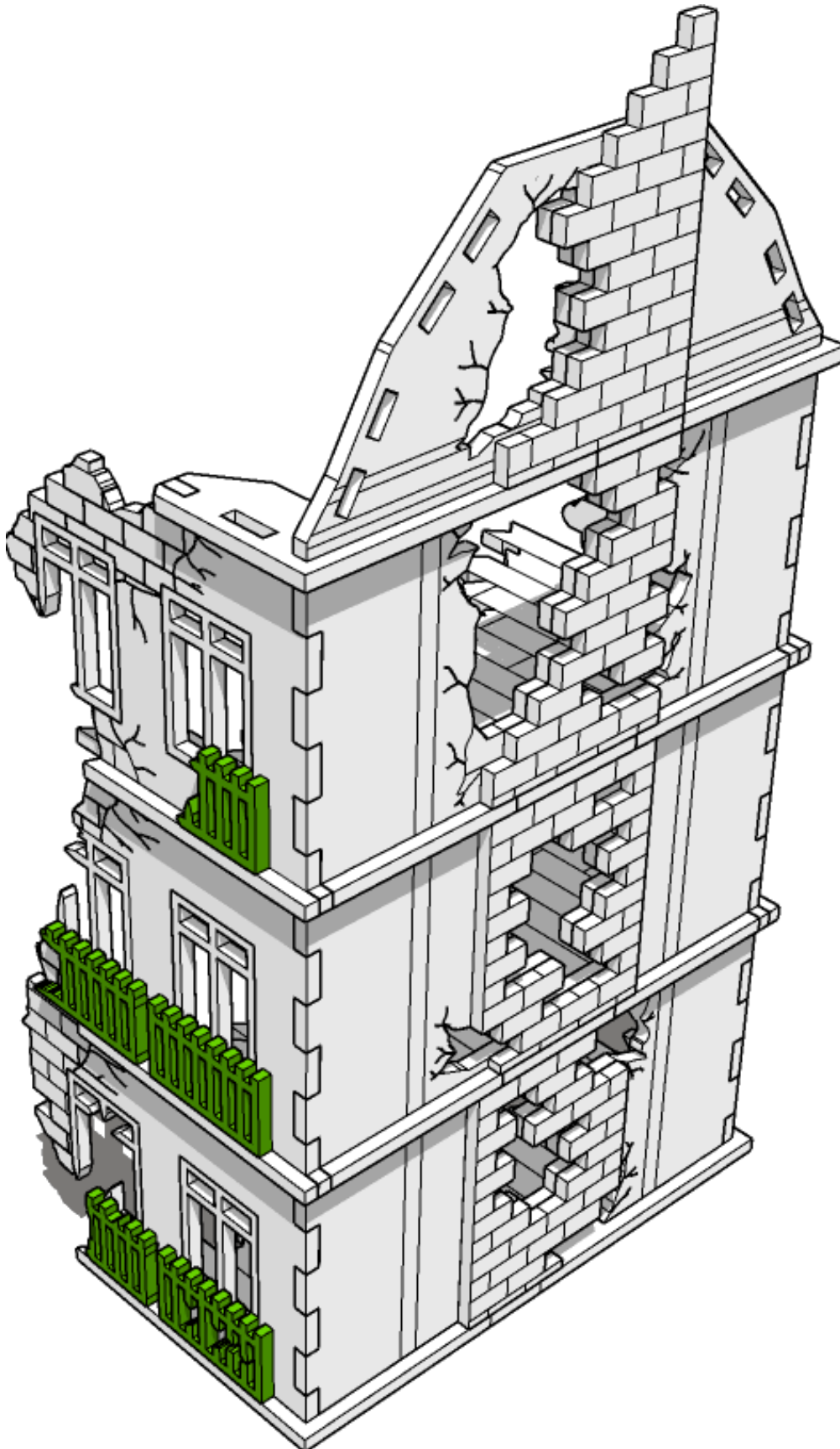



# TABLETOP SCENICS

**TTSC-WAR-O83**  
**City, Corner & Delapidated**  
**Rowhouse Destroyed**

**91**

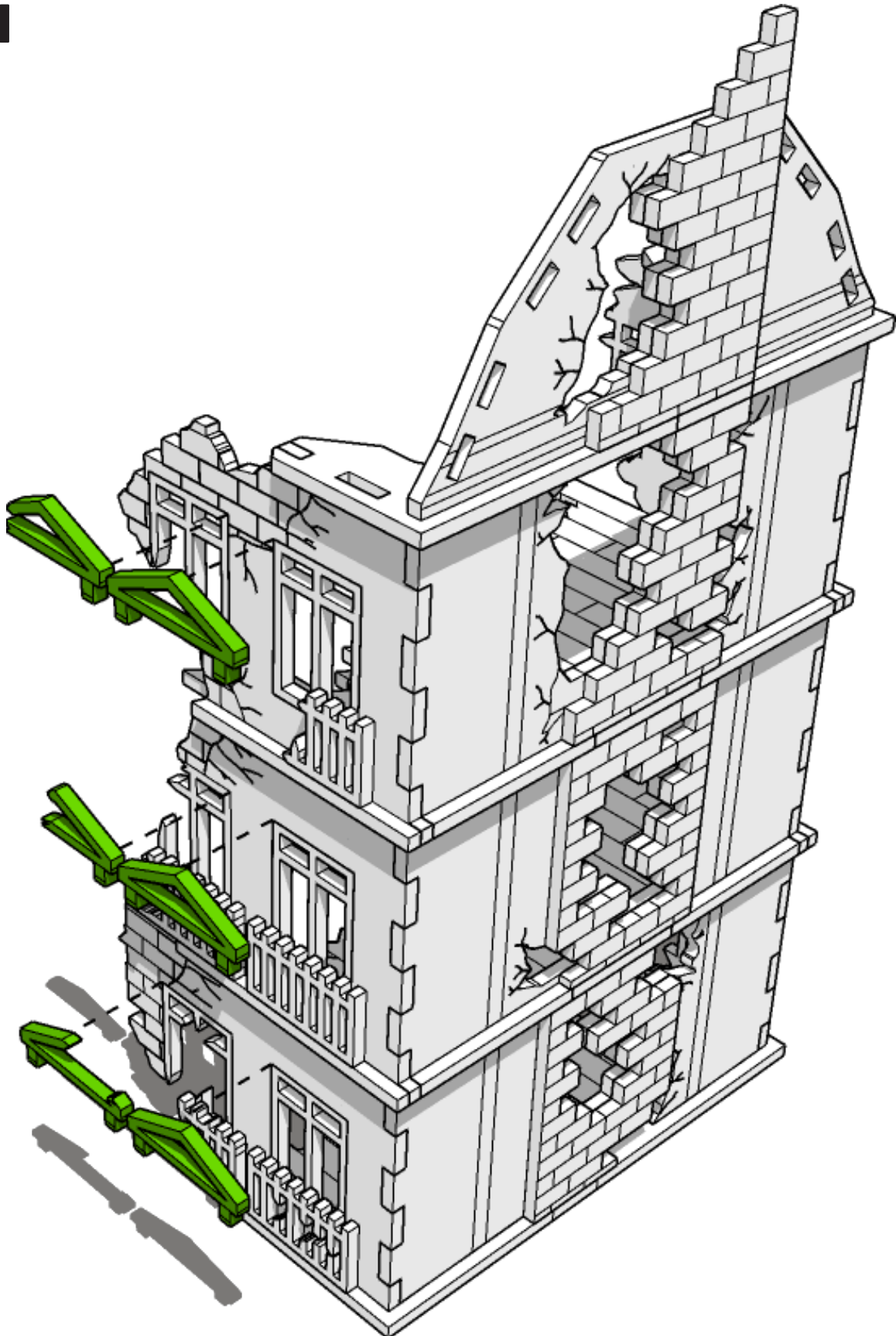



# TABLETOP SCENICS

92

TTSC-WAR-O83  
City, Corner & Delapidated  
Rowhouse Destroyed

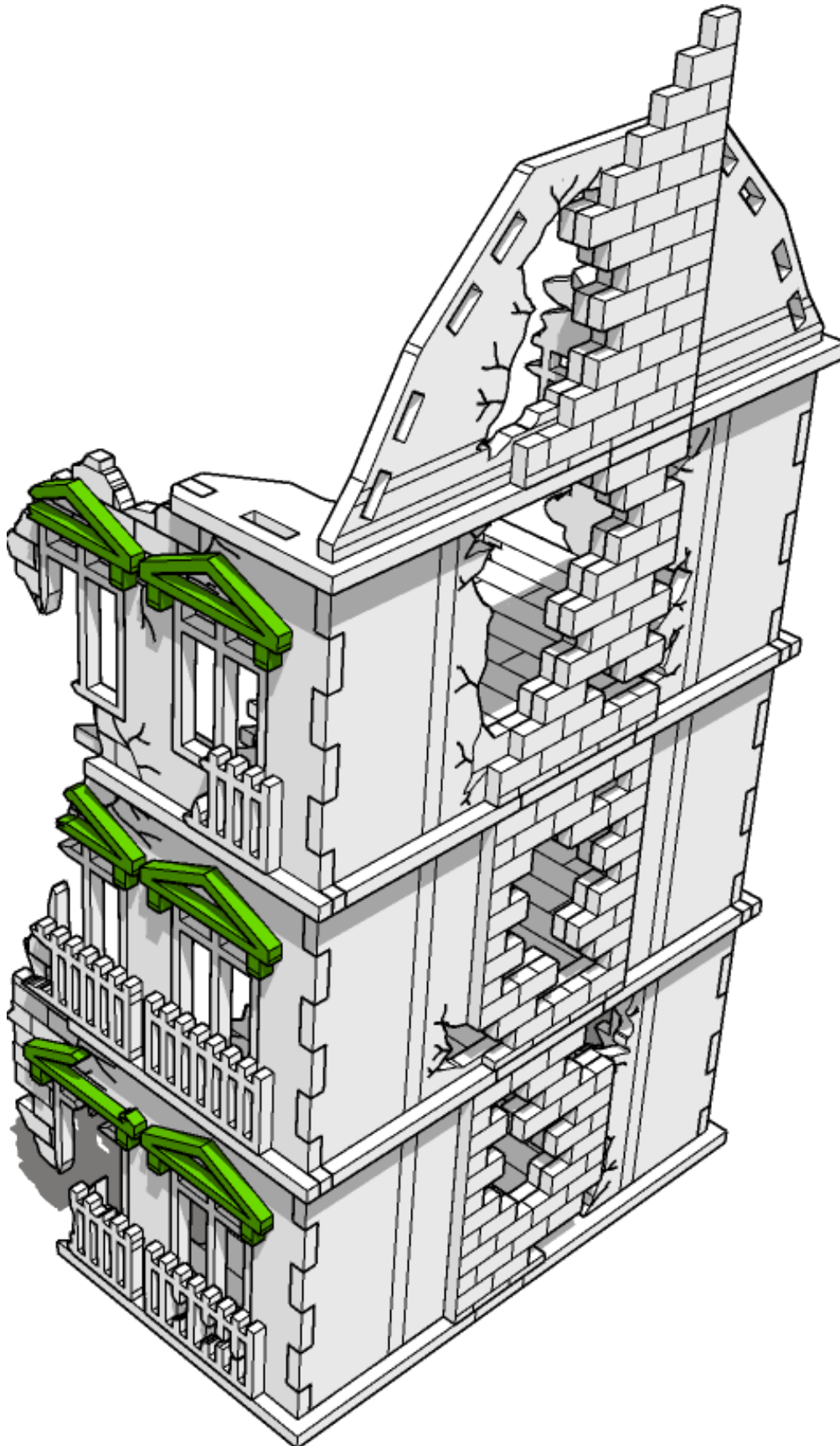



# TABLETOP SCENICS

TTSC-WAR-O83  
City, Corner & Delapidated  
Rowhouse Destroyed

93

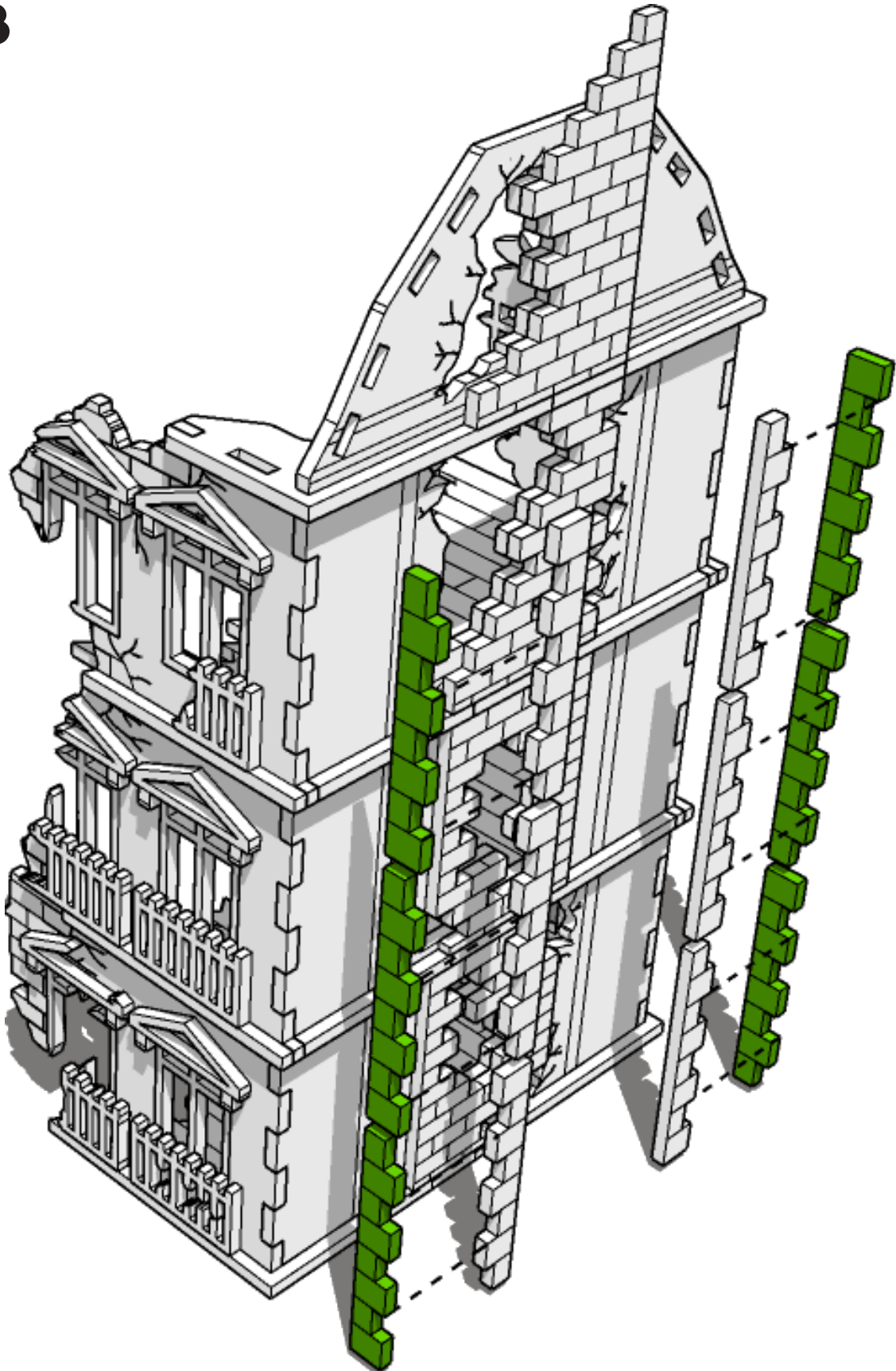



# TABLETOP SCENICS

TTSC-WAR-O83  
City, Corner & Delapidated  
Rowhouse Destroyed

94

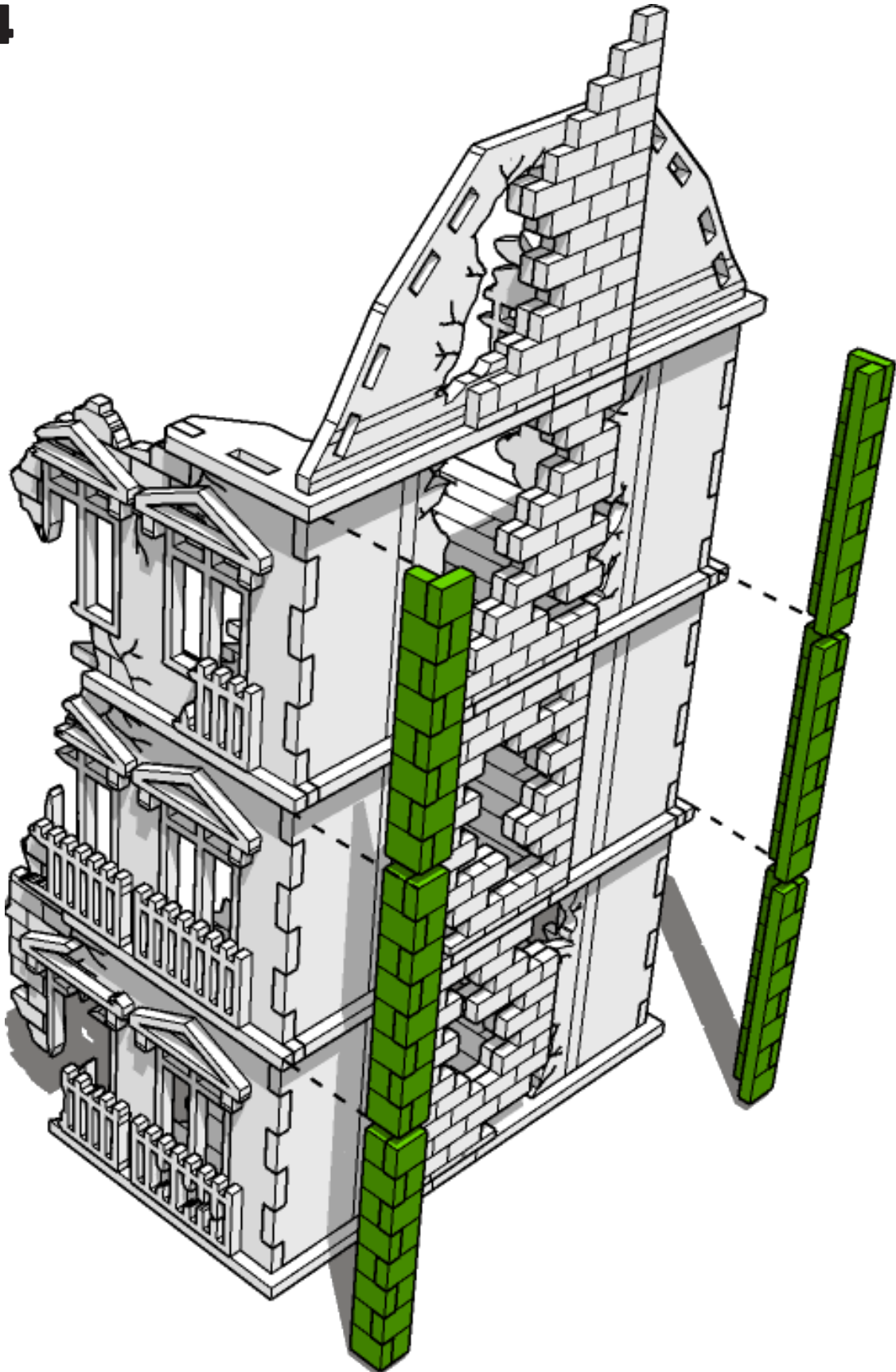



# TABLETOP SCENICS

**TTSC-WAR-O83**  
**City, Corner & Delapidated**  
**Rowhouse Destroyed**

**95**

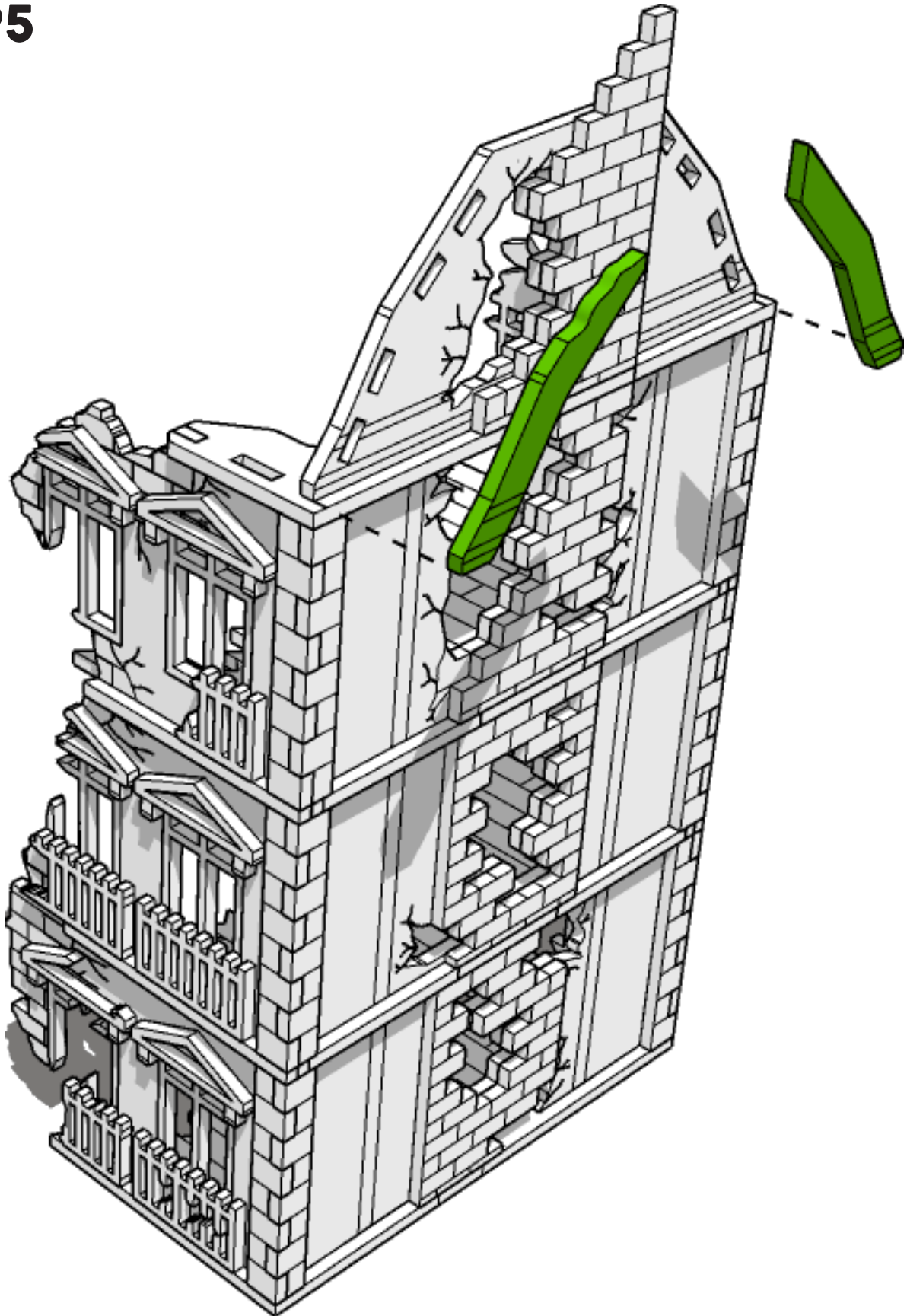





# TABLETOP SCENICS

**TTSC-WAR-O83**  
**City, Corner & Delapidated**  
**Rowhouse Destroyed**

**96**

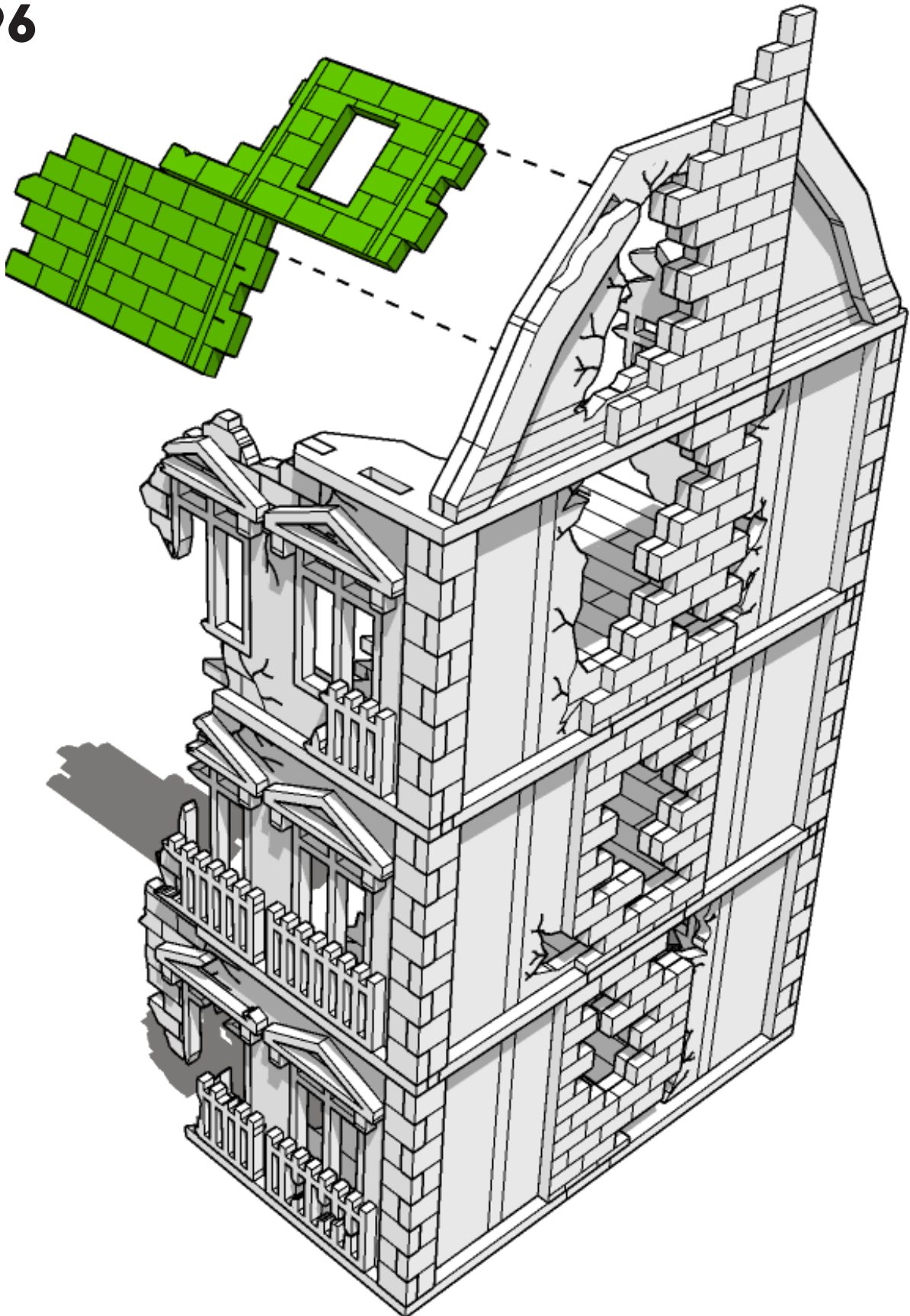



# TABLETOP SCENICS

**TTSC-WAR-O83**  
**City, Corner & Delapidated**  
**Rowhouse Destroyed**

**97**

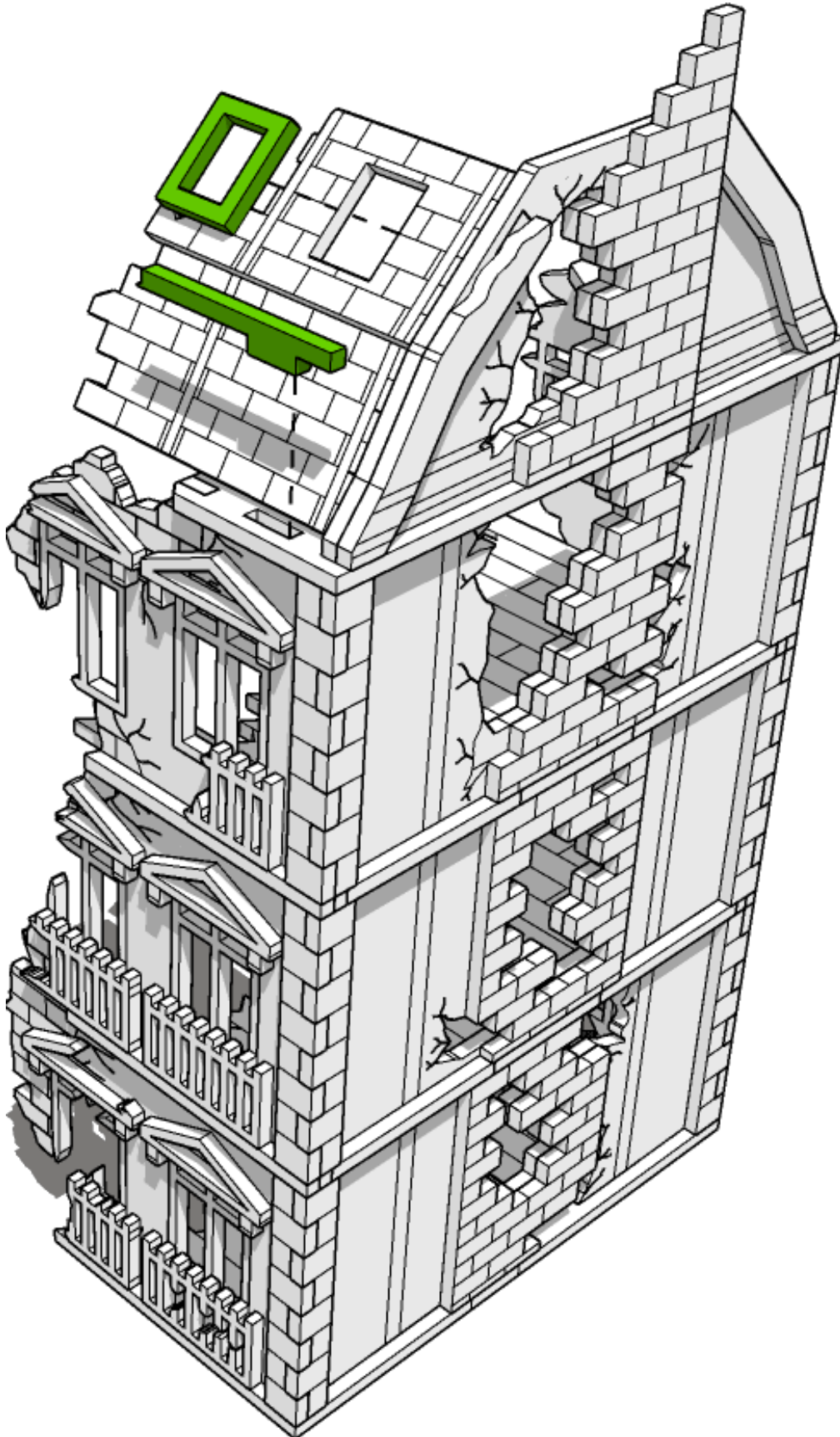



# TABLETOP SCENICS

TTSC-WAR-O83  
City, Corner & Delapidated  
Rowhouse Destroyed

98

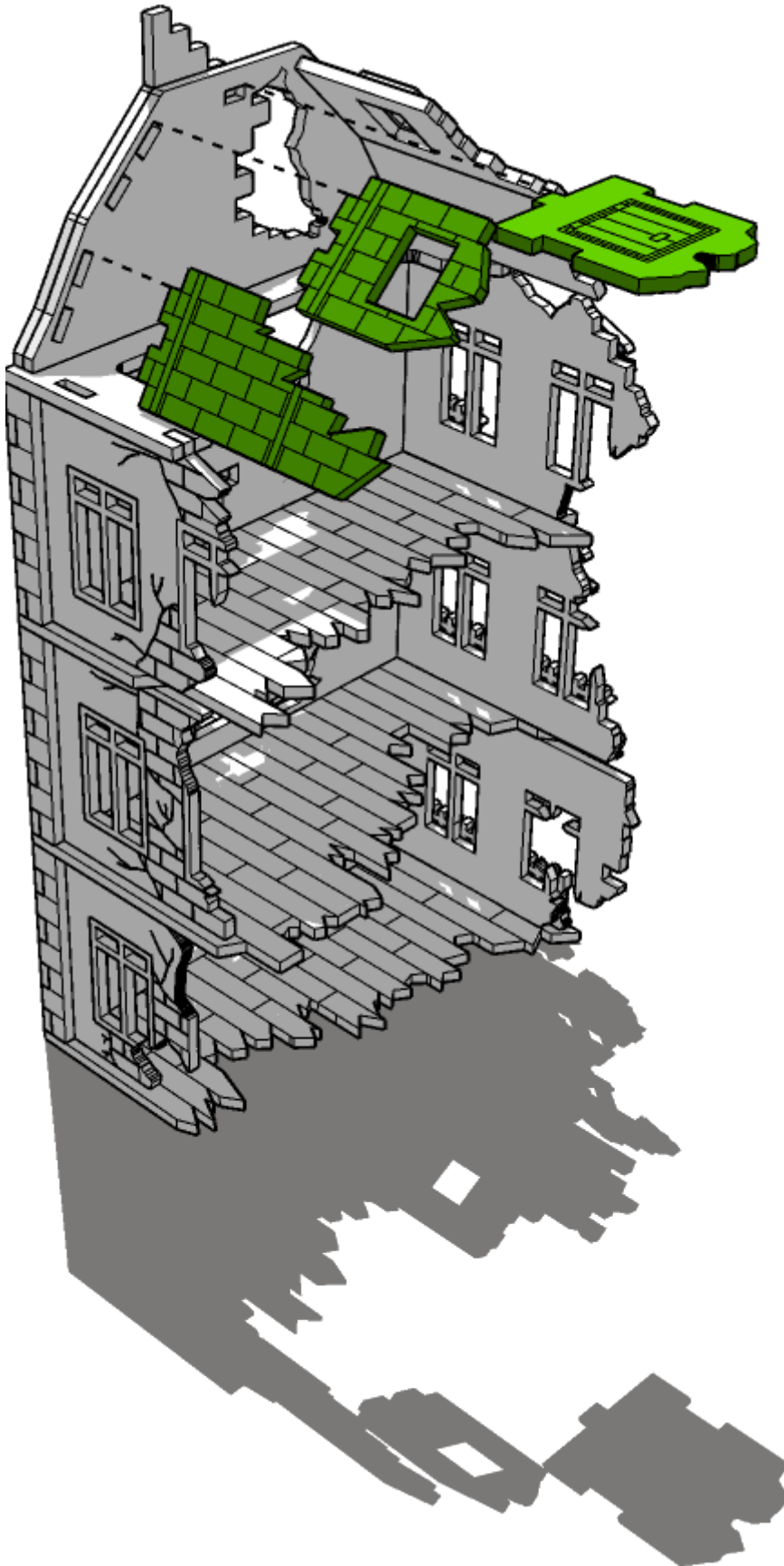



# TABLETOP SCENICS

TTSC-WAR-O83  
City, Corner & Delapidated  
Rowhouse Destroyed

99

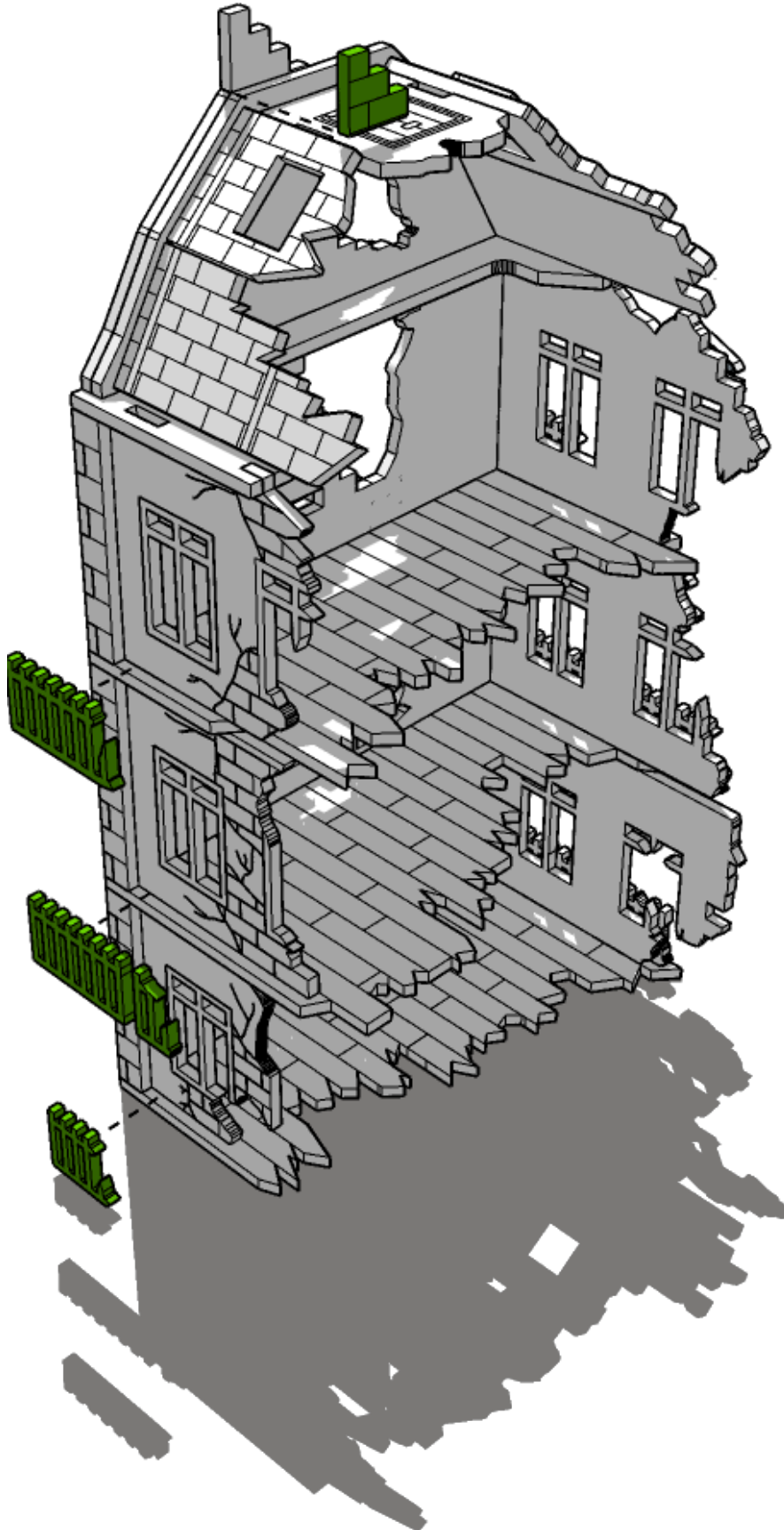



# TABLETOP SCENICS

100

TTSC-WAR-O83  
City, Corner & Delapidated  
Rowhouse Destroyed

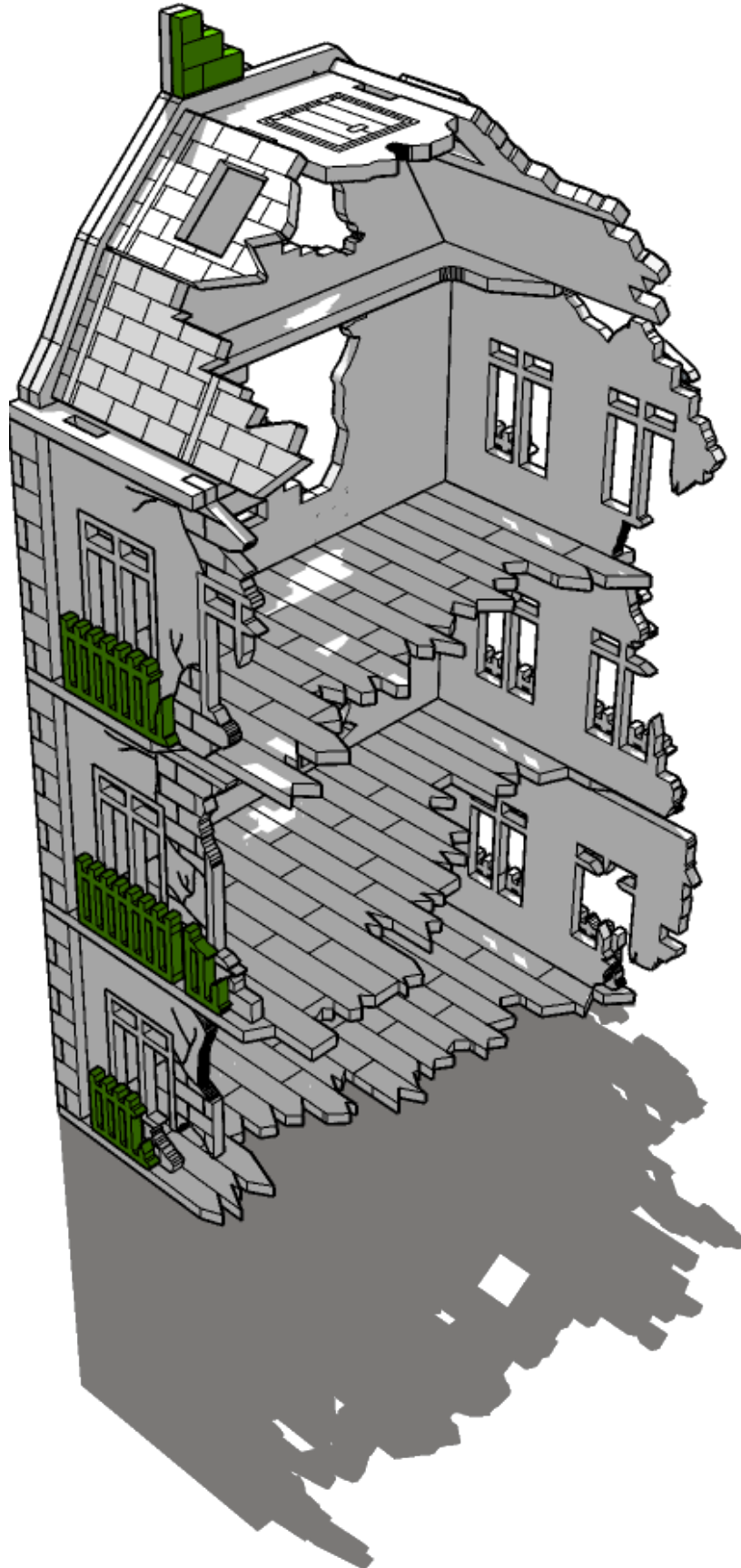



# TABLETOP SCENICS

101

TTSC-WAR-O83  
City, Corner & Delapidated  
Rowhouse Destroyed

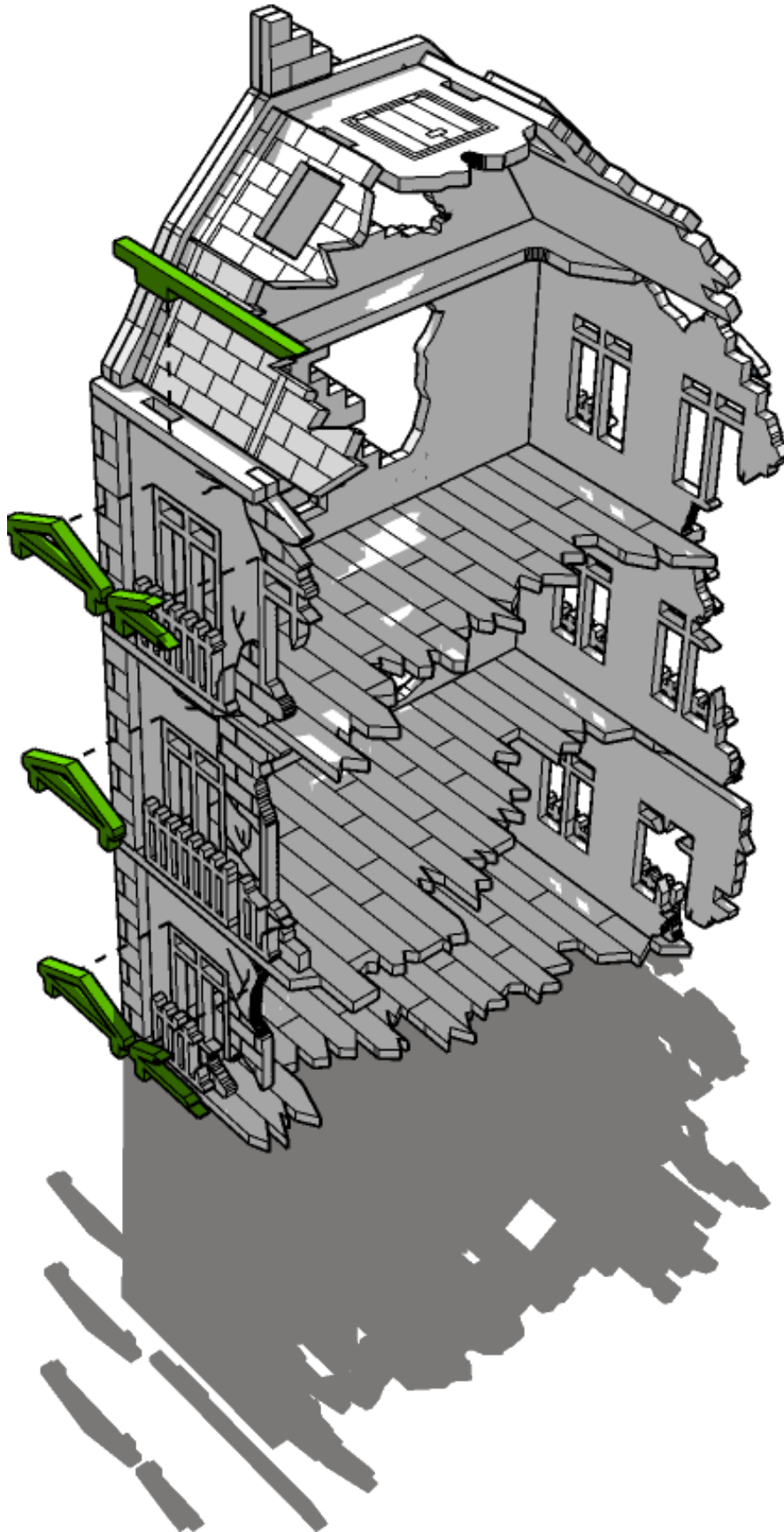



# TABLETOP SCENICS

TTSC-WAR-083  
City, Corner & Delapidated  
Rowhouse Destroyed

102

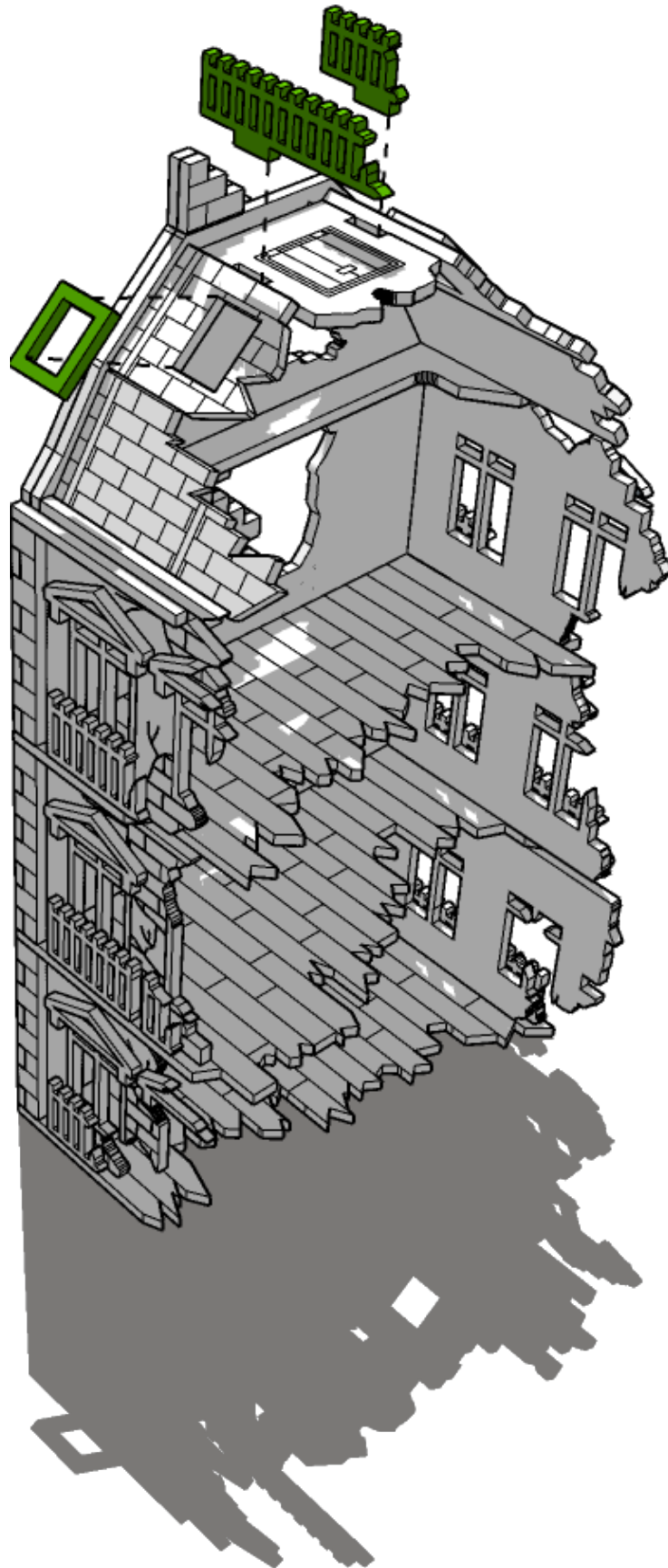



# TABLETOP SCENICS

103

TTSC-WAR-O83  
City, Corner & Delapidated  
Rowhouse Destroyed

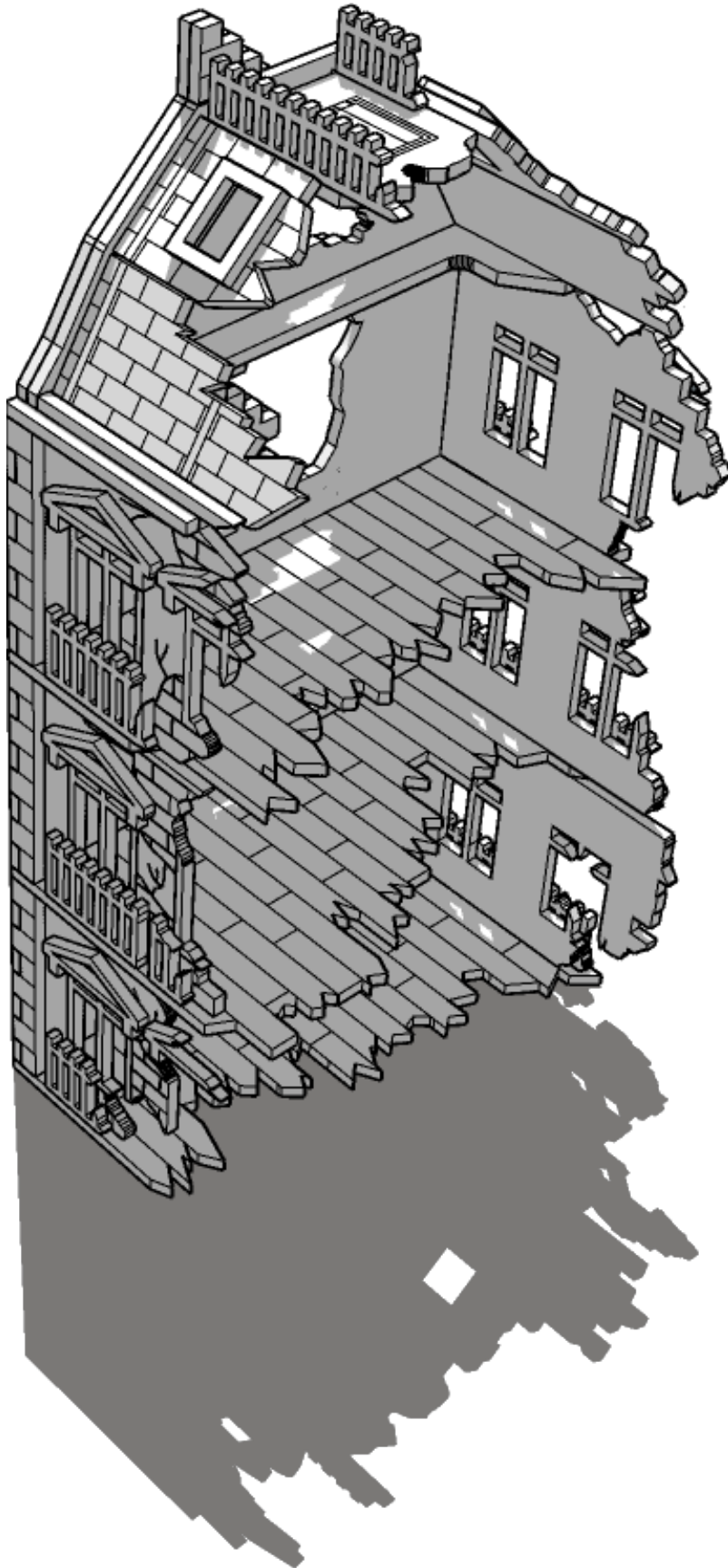





TABLETOP  
**SCENICS**

**TTSC-WAR-O83**  
**City, Corner & Delapidated**  
**Rowhouse Destroyed**

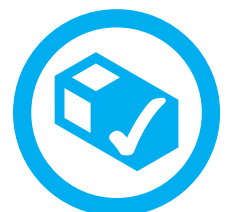
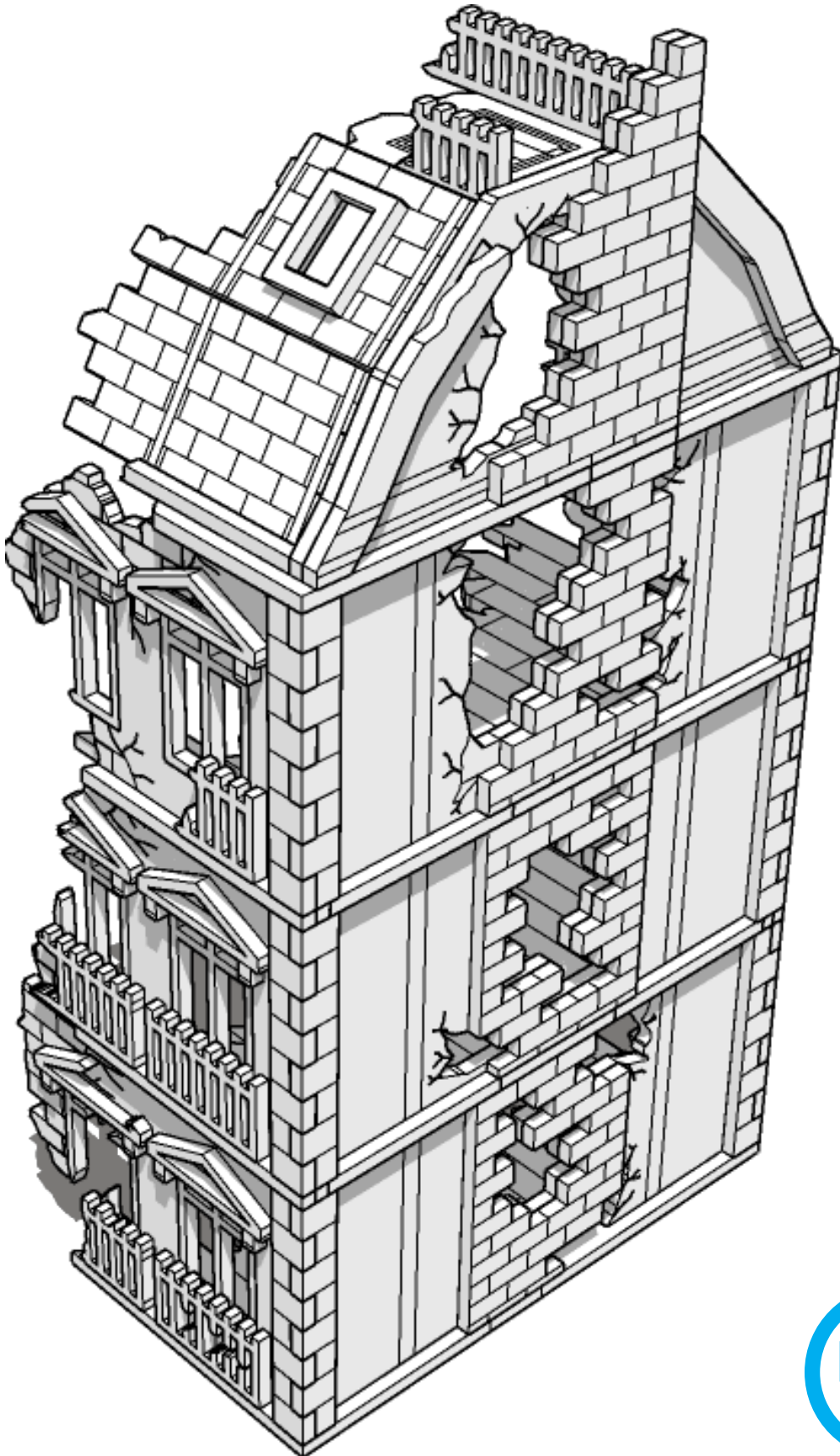

 **TTCOMBAT**



# TABLETOP SCENICS

105

TTSC-WAR-O83  
City, Corner & Delapidated  
Rowhouse Destroyed

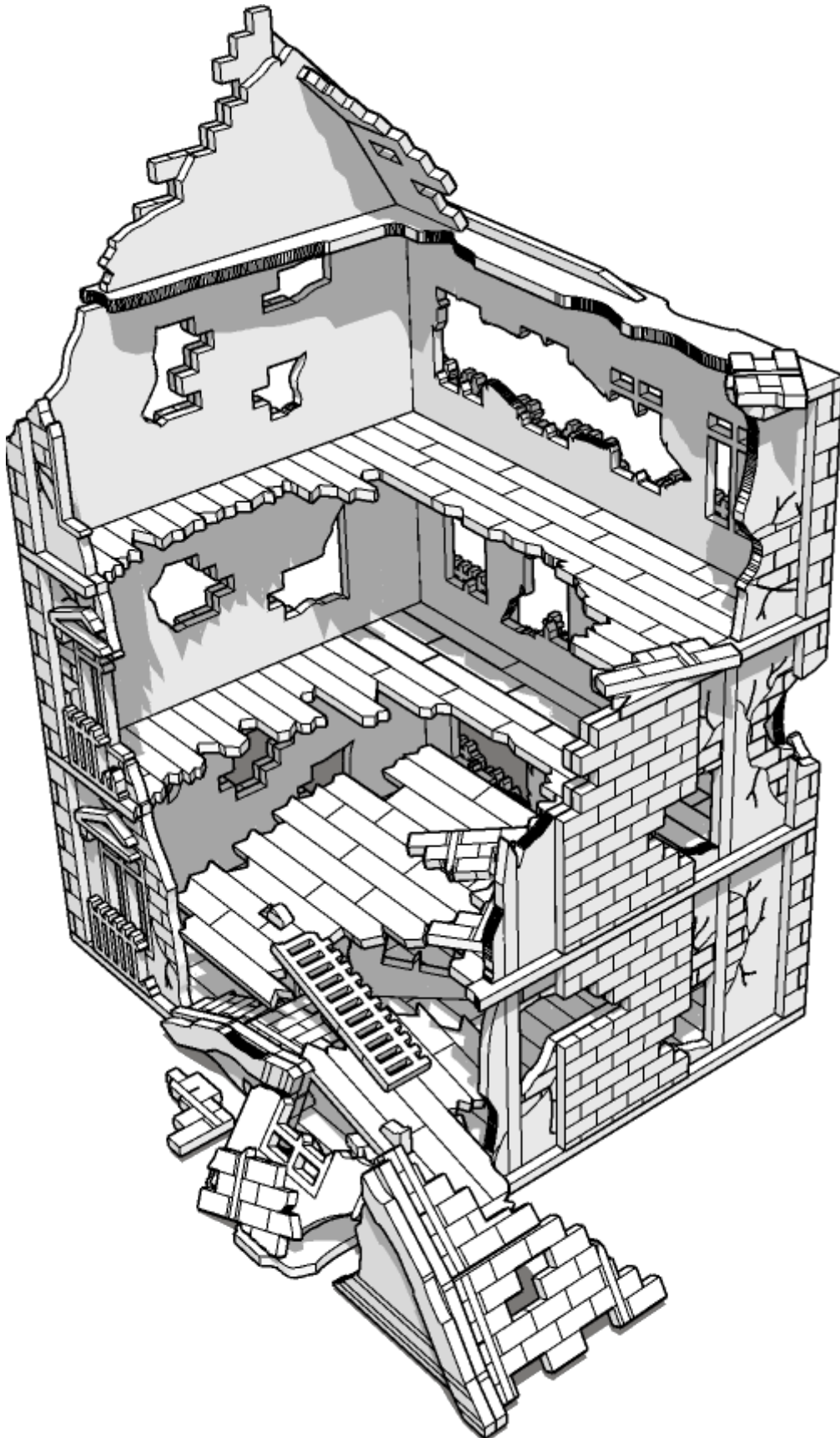



# TABLETOP SCENICS

106

**TTSC-WAR-O83**  
**City, Corner & Delapidated**  
**Rowhouse Destroyed**

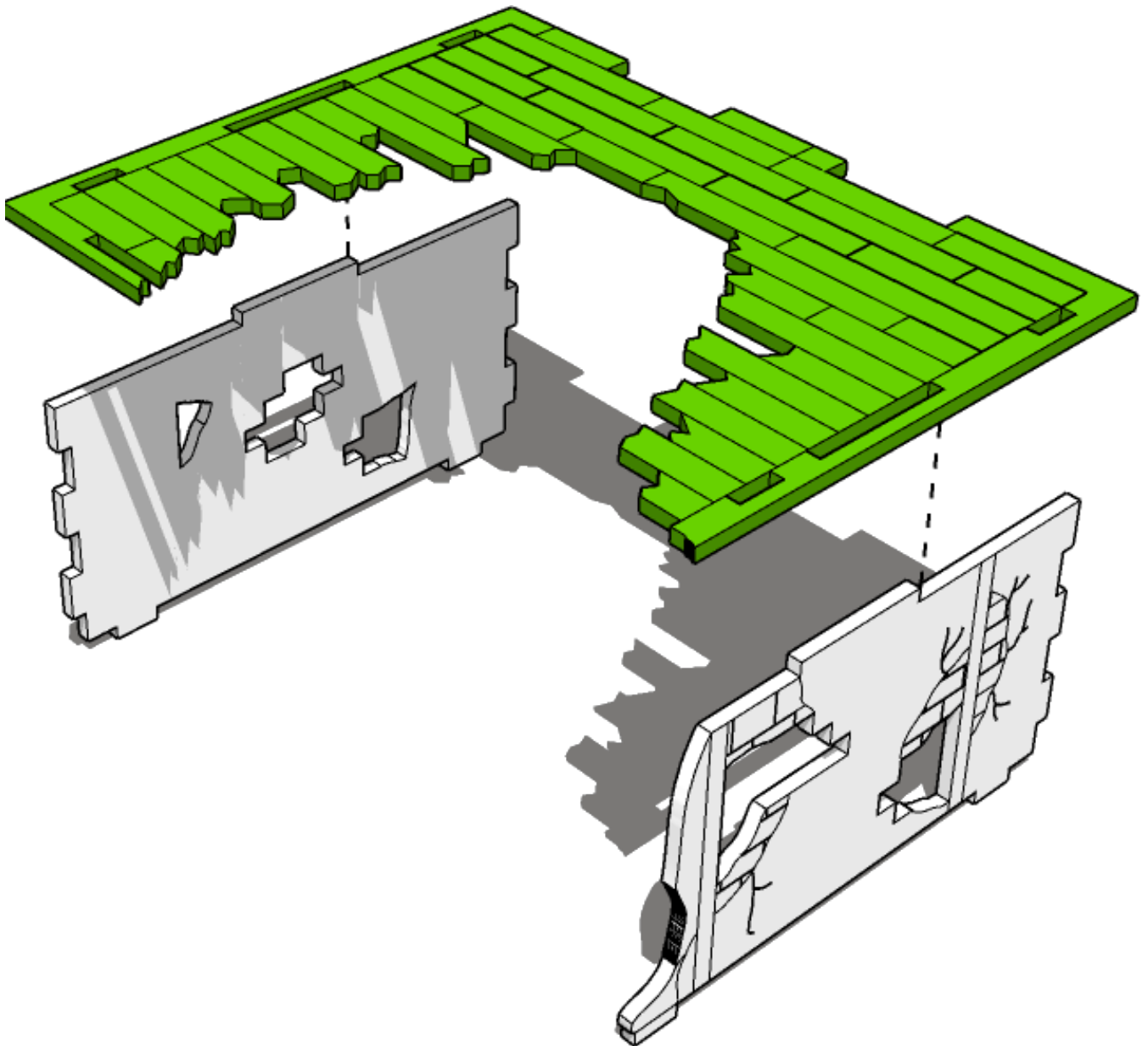



# TABLETOP SCENICS

107

**TTSC-WAR-O83**  
**City, Corner & Delapidated**  
**Rowhouse Destroyed**

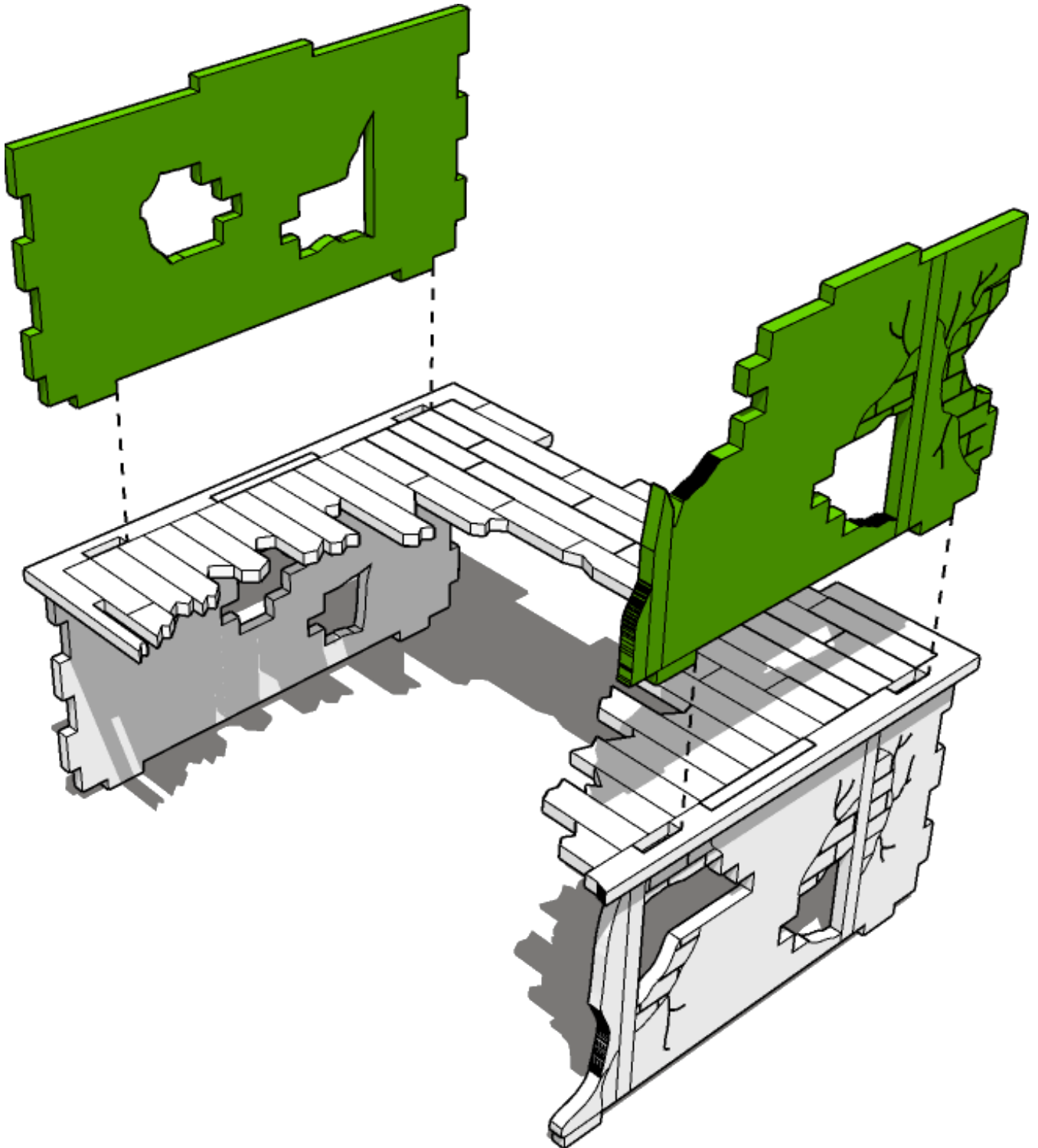



# TABLETOP SCENICS

108

**TTSC-WAR-O83**  
**City, Corner & Delapidated**  
**Rowhouse Destroyed**

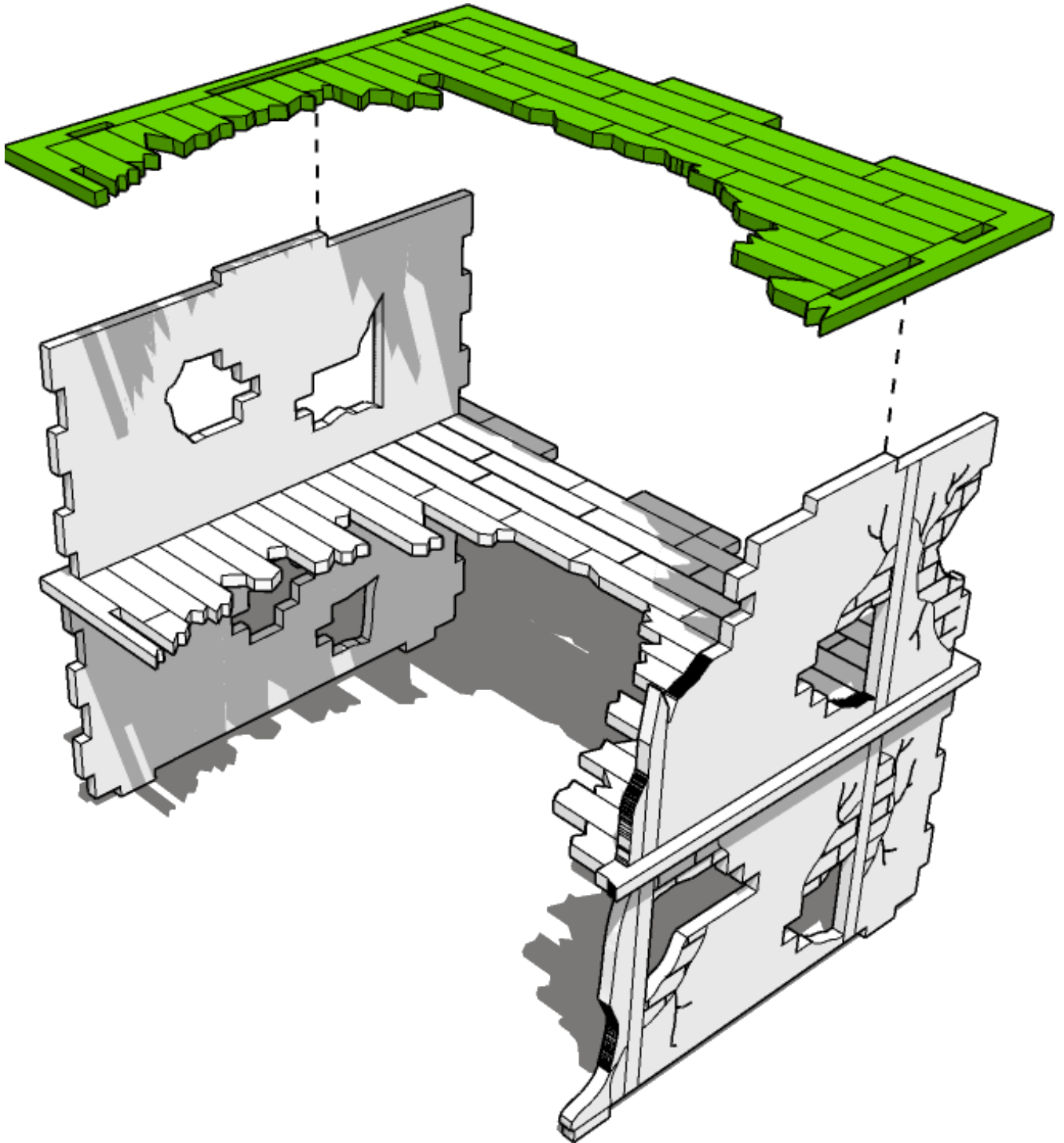



# TABLETOP SCENICS

**TTSC-WAR-O83**  
**City, Corner & Delapidated**  
**Rowhouse Destroyed**

**109**

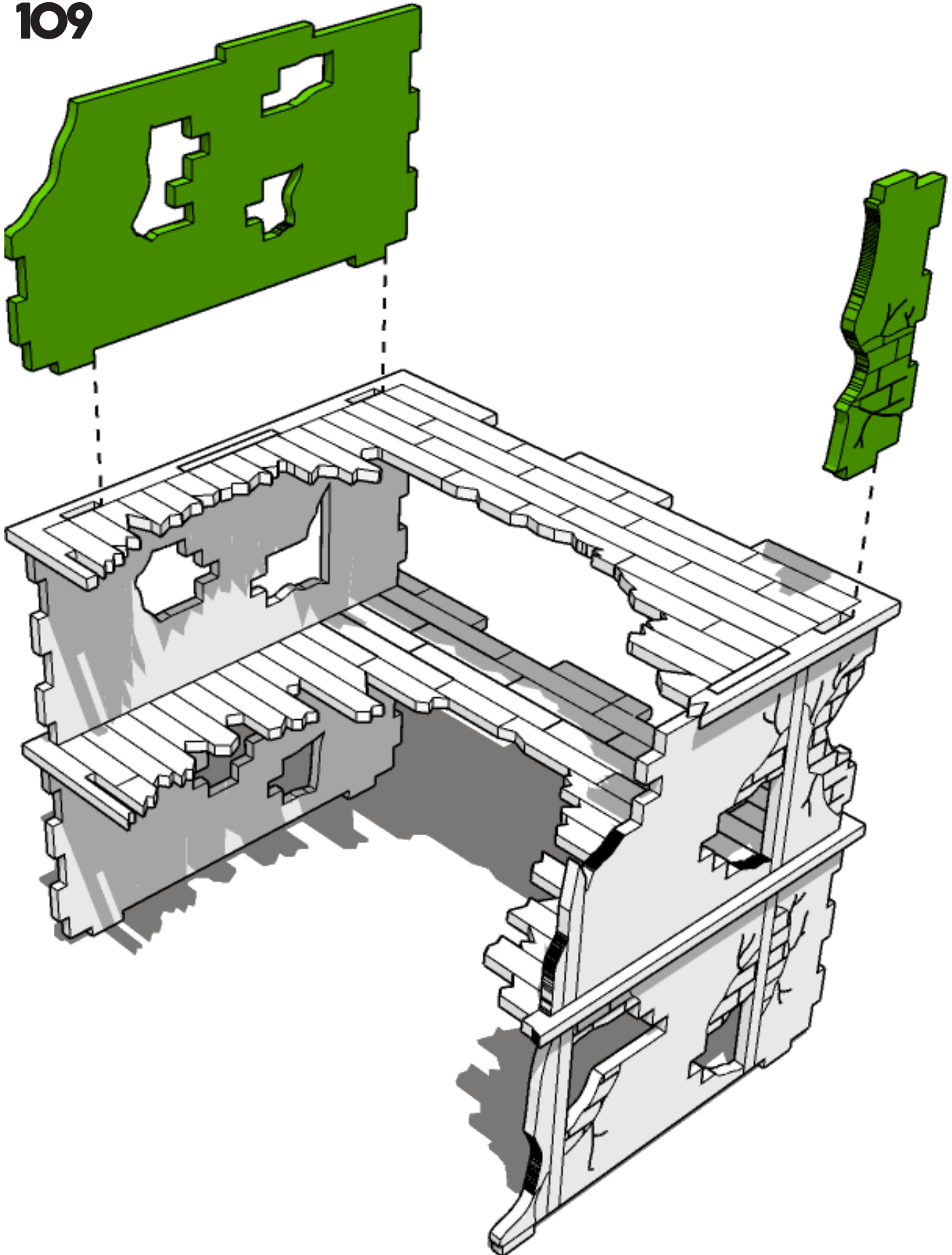



# TABLETOP SCENICS

110

**TTSC-WAR-O83**  
**City, Corner & Delapidated**  
**Rowhouse Destroyed**

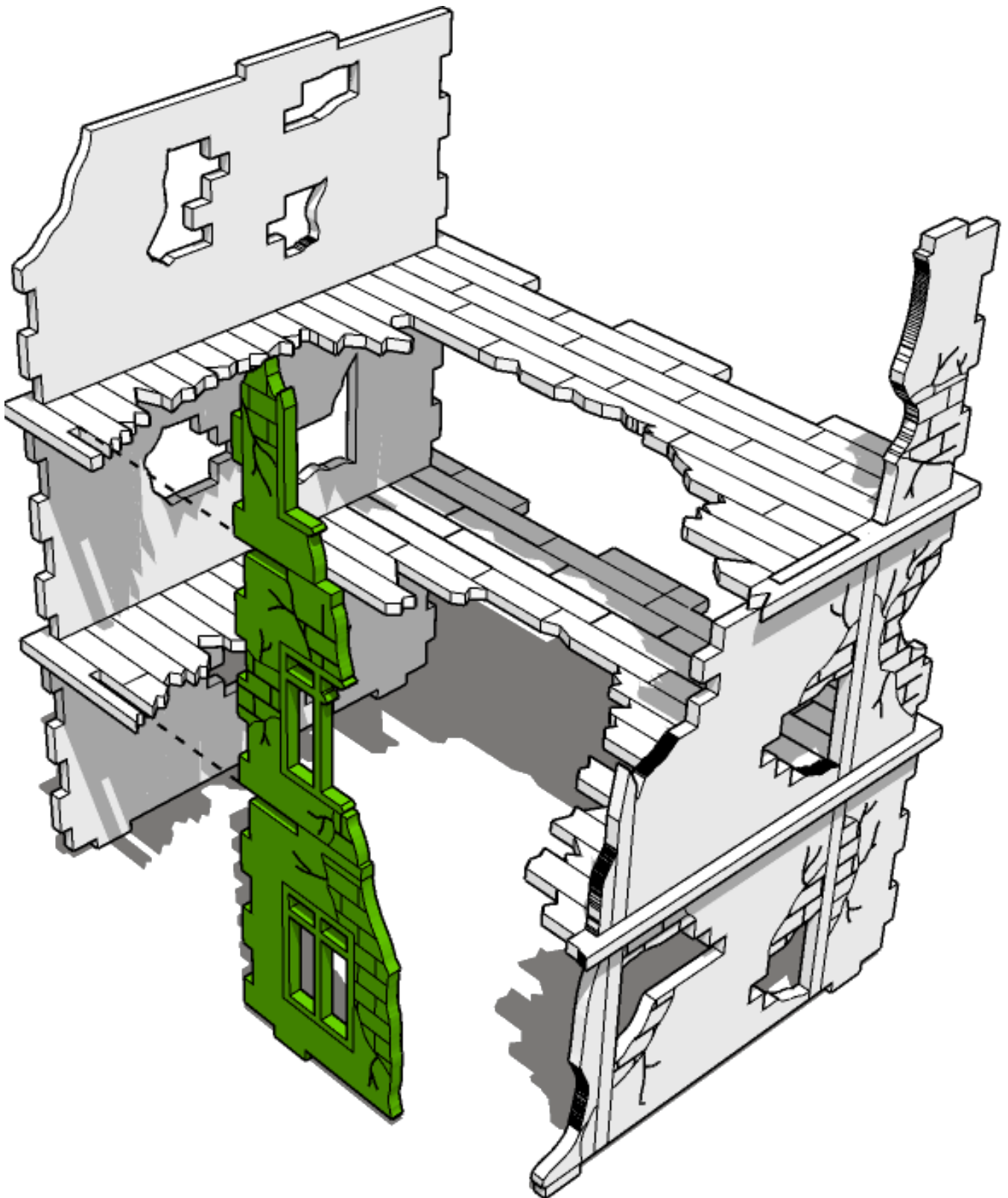



# TABLETOP SCENICS

**TTSC-WAR-083**  
**City, Corner & Delapidated**  
**Rowhouse Destroyed**

**111**

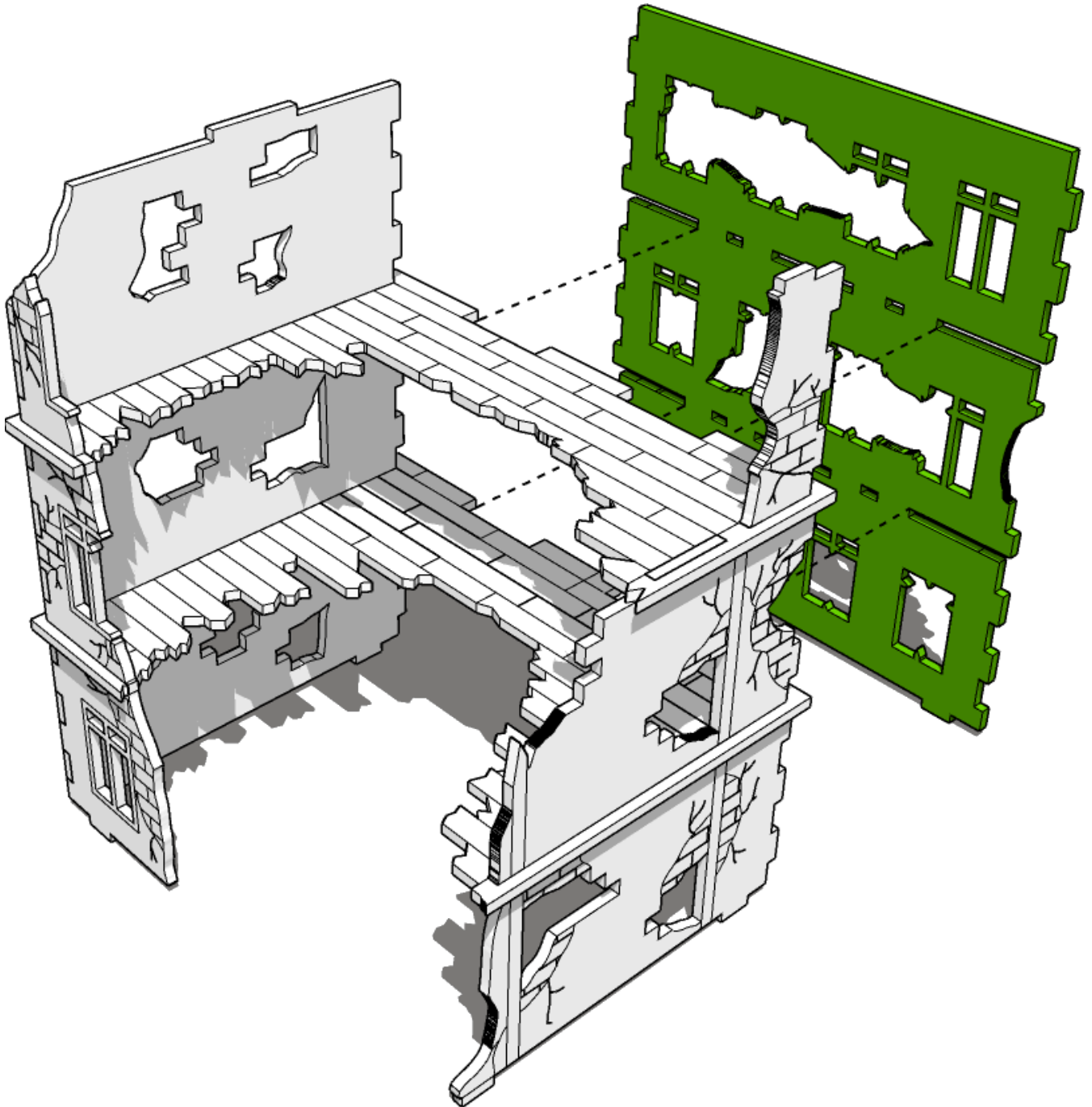





# TABLETOP SCENICS

**TTSC-WAR-O83**  
**City, Corner & Delapidated**  
**Rowhouse Destroyed**

**112**

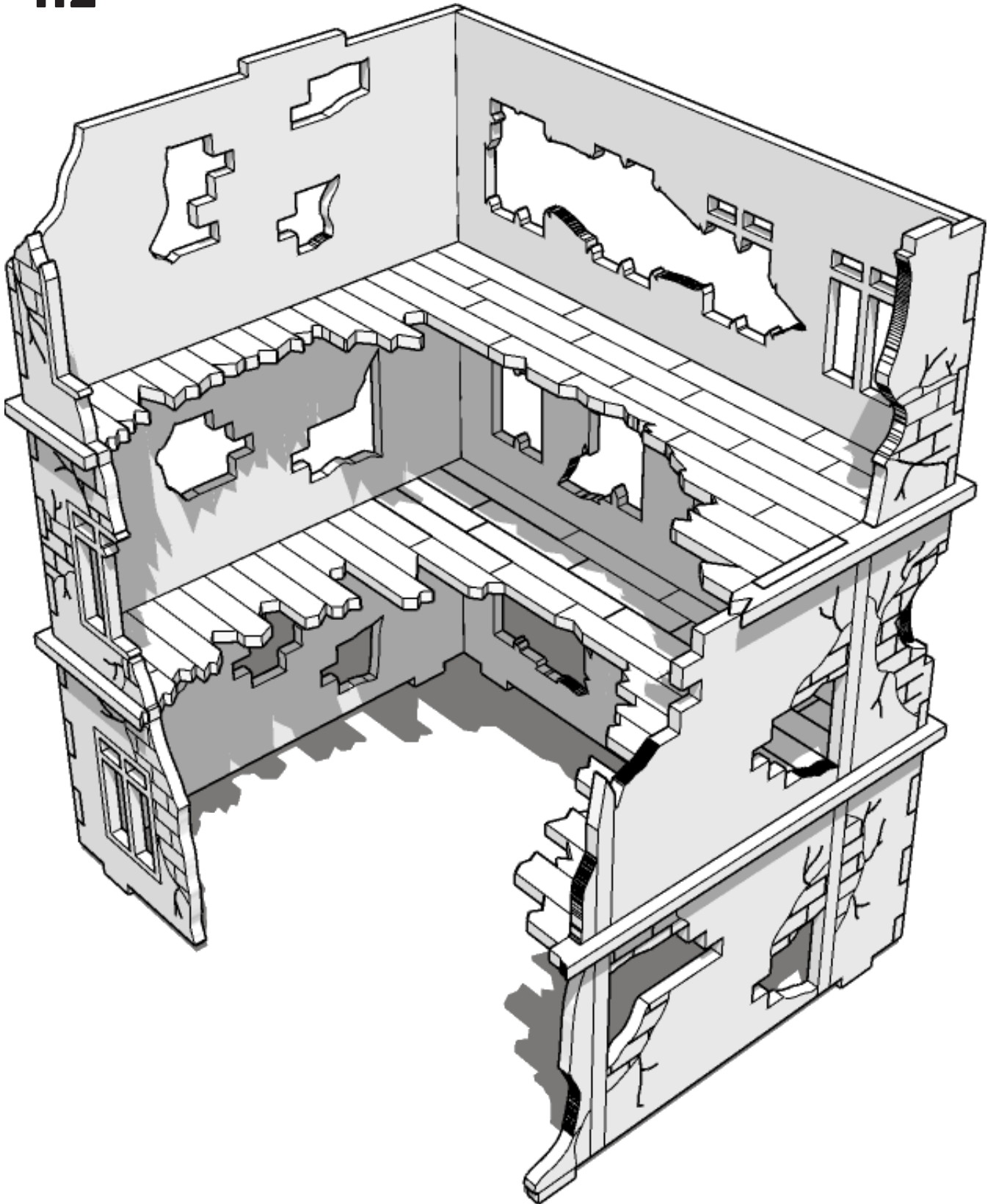



# TABLETOP SCENICS

**TTSC-WAR-O83**  
**City, Corner & Delapidated**  
**Rowhouse Destroyed**

**113**

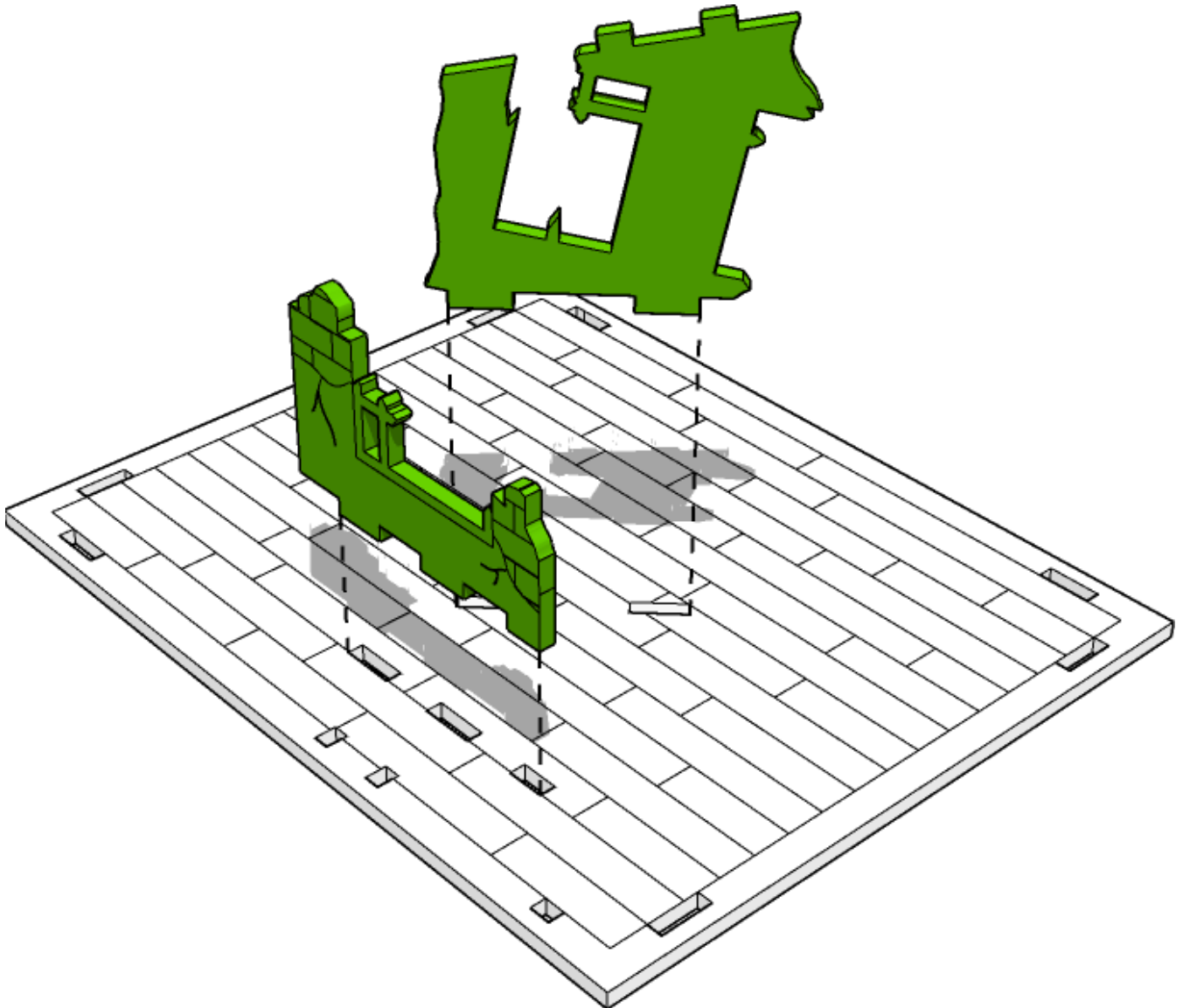



# TABLETOP SCENICS

114

**TTSC-WAR-O83**  
**City, Corner & Delapidated**  
**Rowhouse Destroyed**

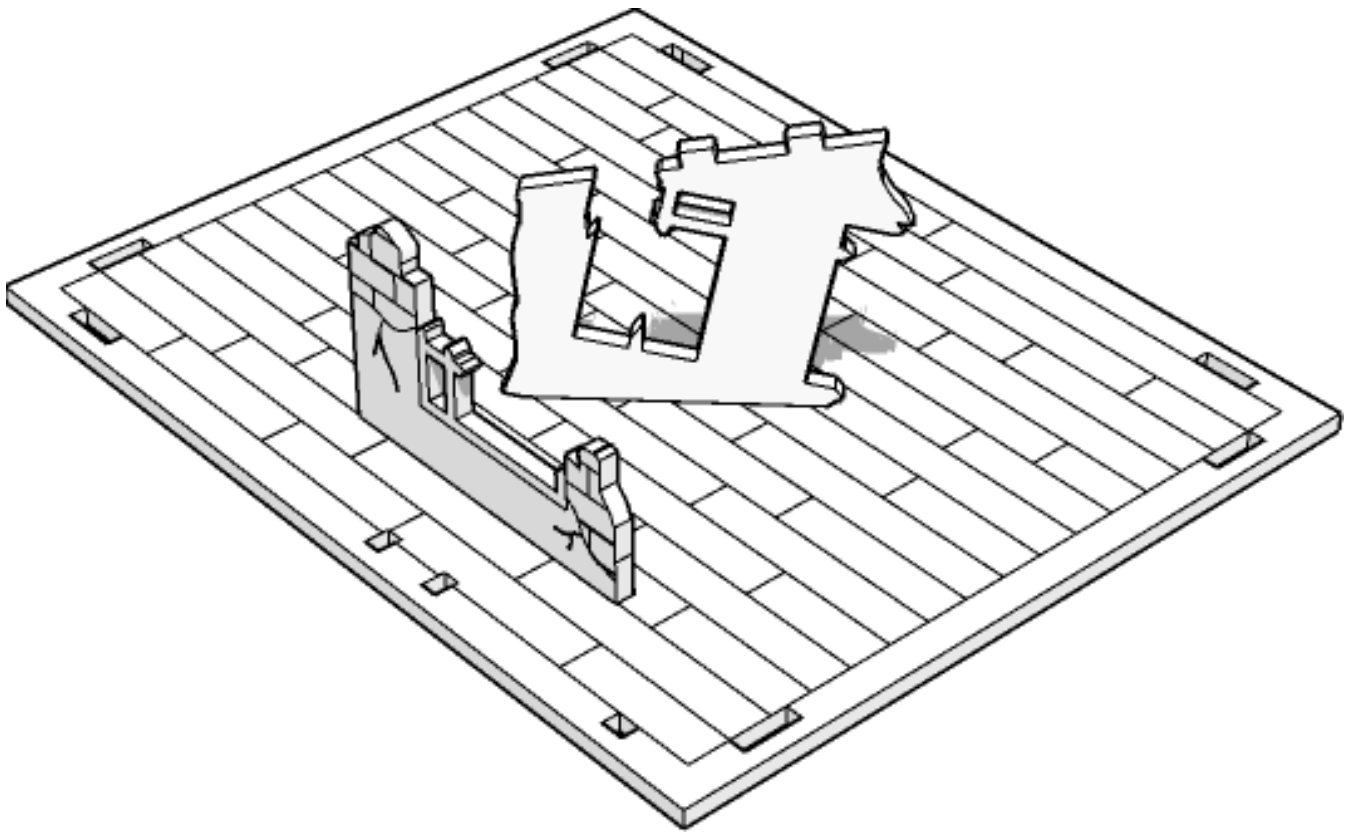



# TABLETOP SCENICS

**TTSC-WAR-O83**  
**City, Corner & Delapidated**  
**Rowhouse Destroyed**

**115**

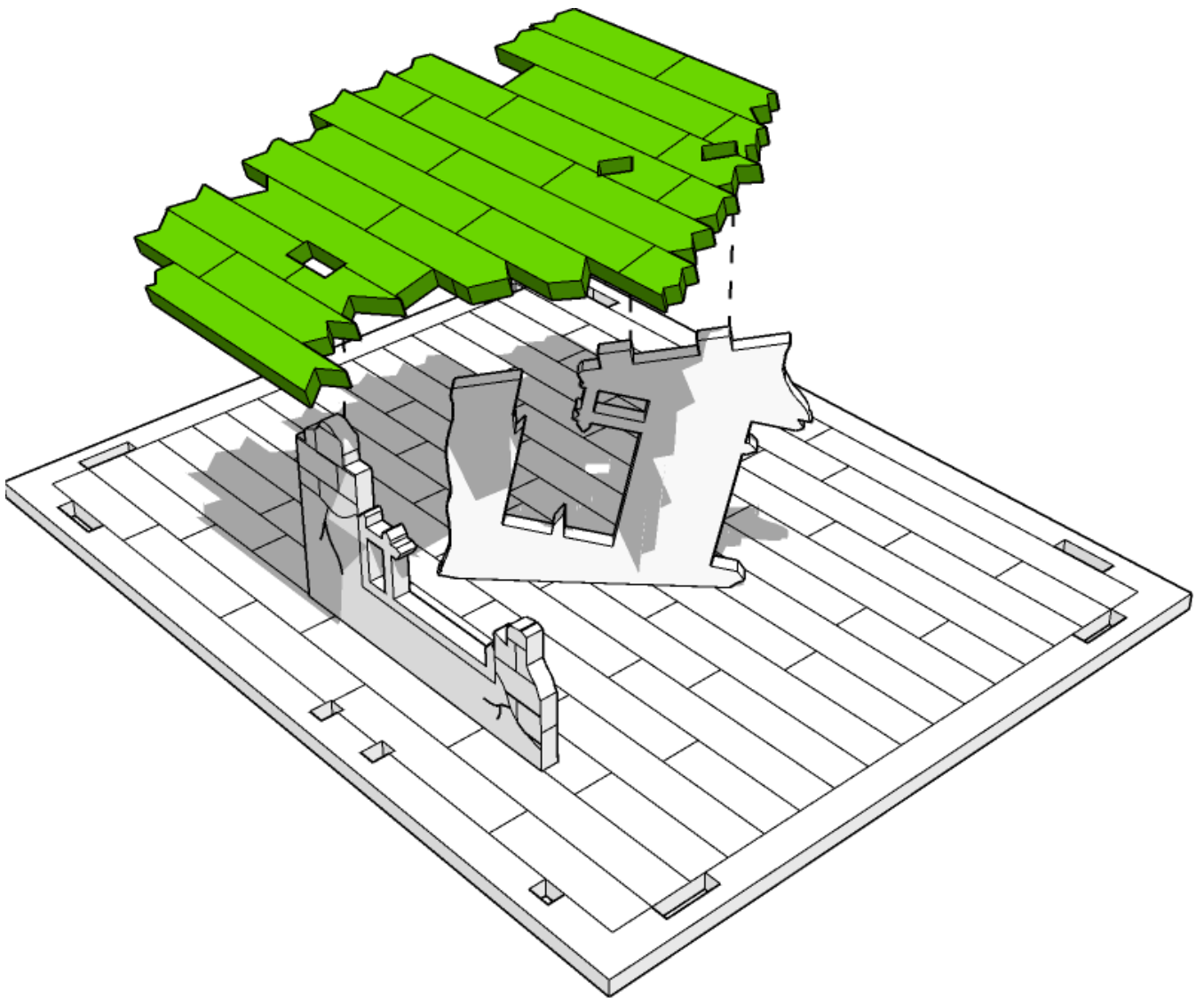



# TABLETOP SCENICS

116

**TTSC-WAR-O83**  
**City, Corner & Delapidated**  
**Rowhouse Destroyed**

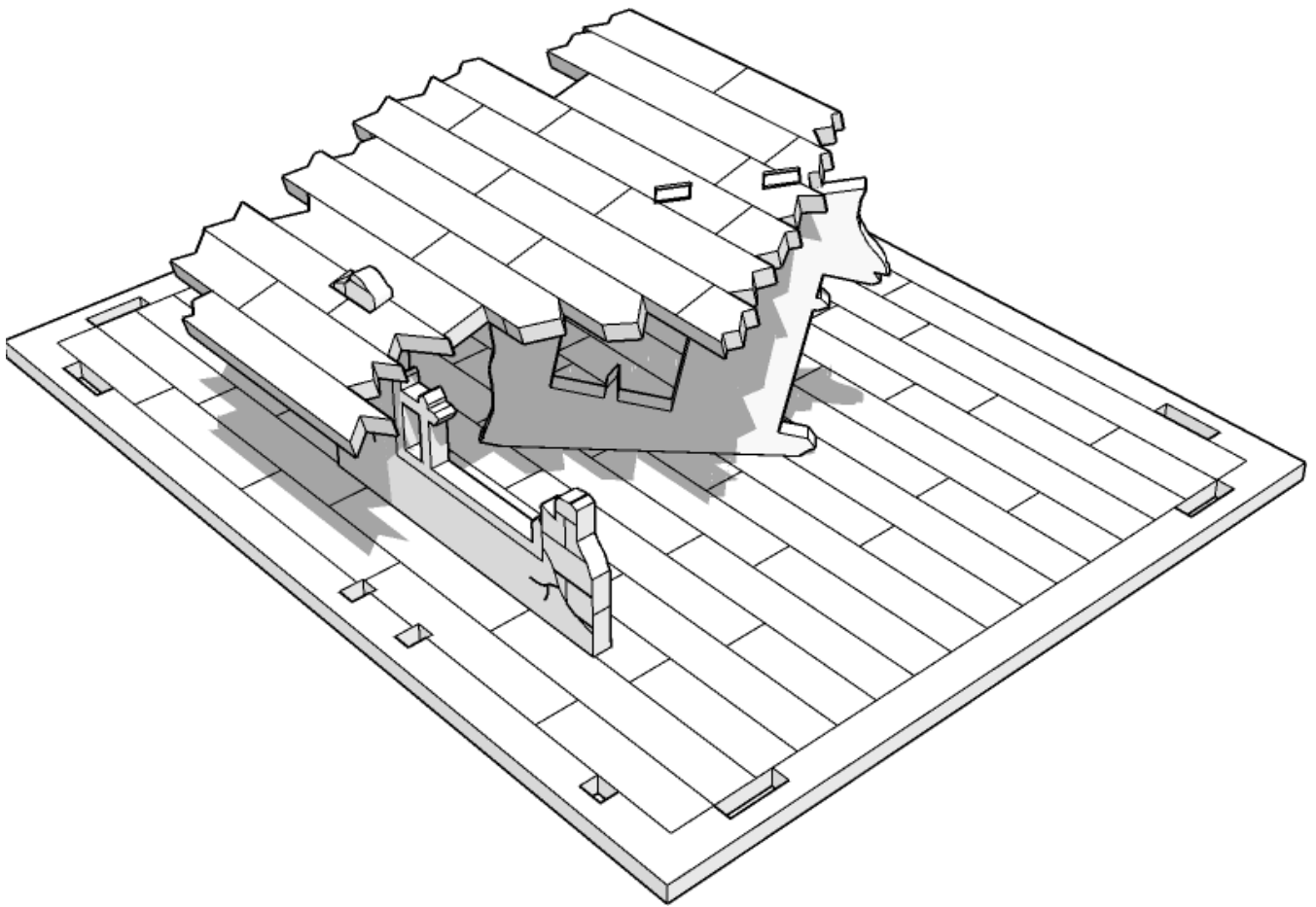



# TABLETOP SCENICS

**TTSC-WAR-O83**  
**City, Corner & Delapidated**  
**Rowhouse Destroyed**

**117**

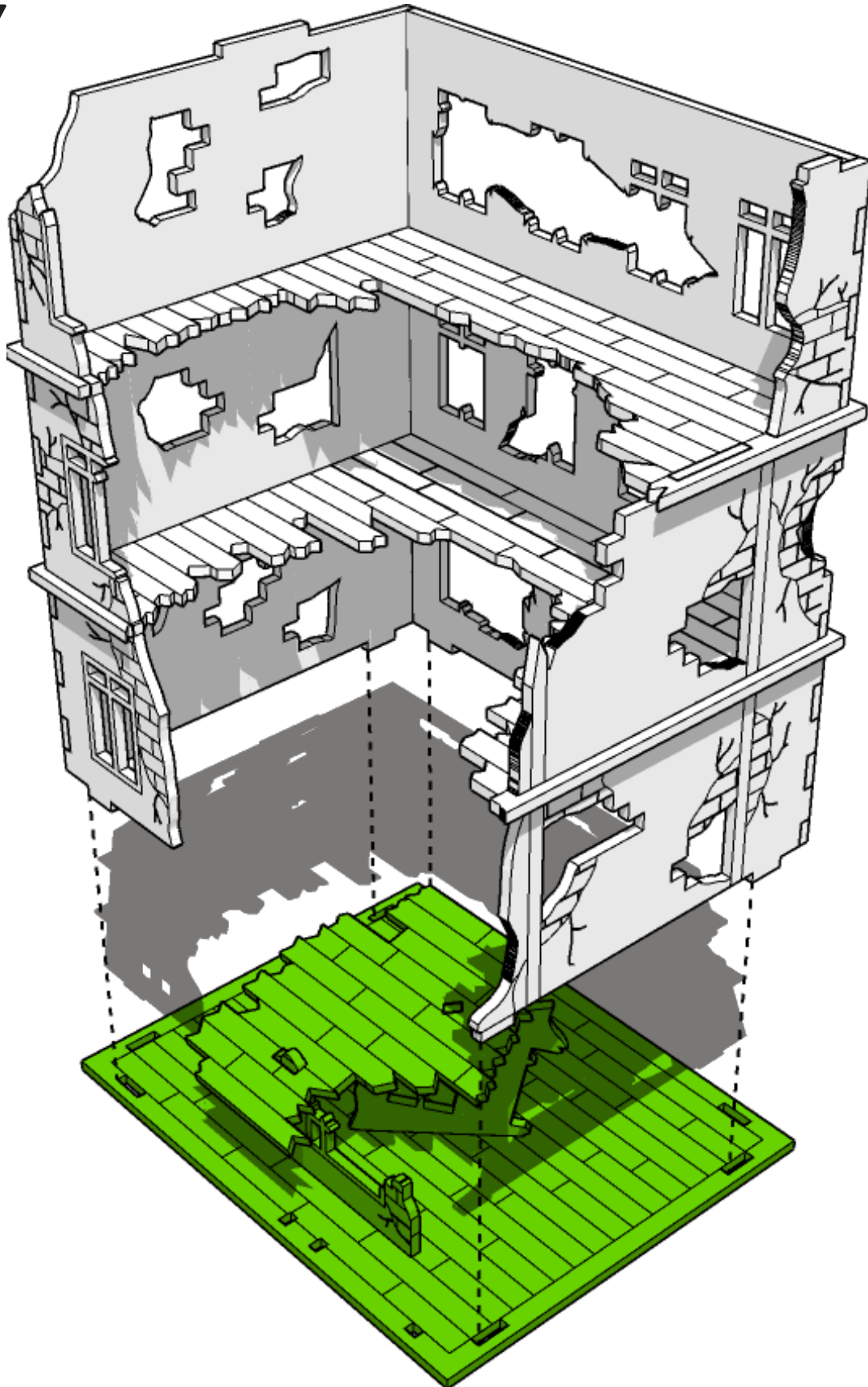



# TABLETOP SCENICS

**TTSC-WAR-O83**  
**City, Corner & Delapidated**  
**Rowhouse Destroyed**

**118**

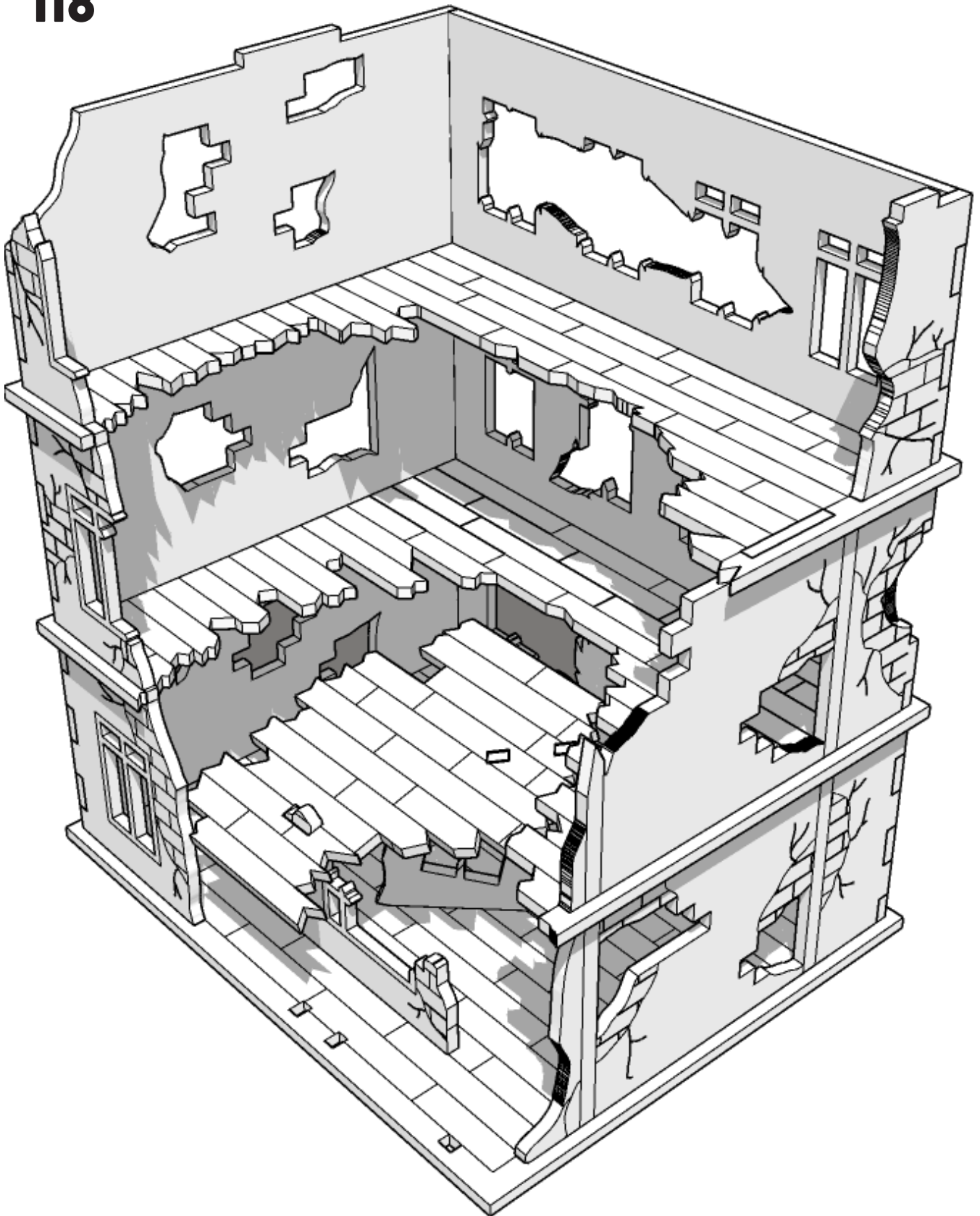



# TABLETOP SCENICS

**TTSC-WAR-O83**  
**City, Corner & Delapidated**  
**Rowhouse Destroyed**

**119**

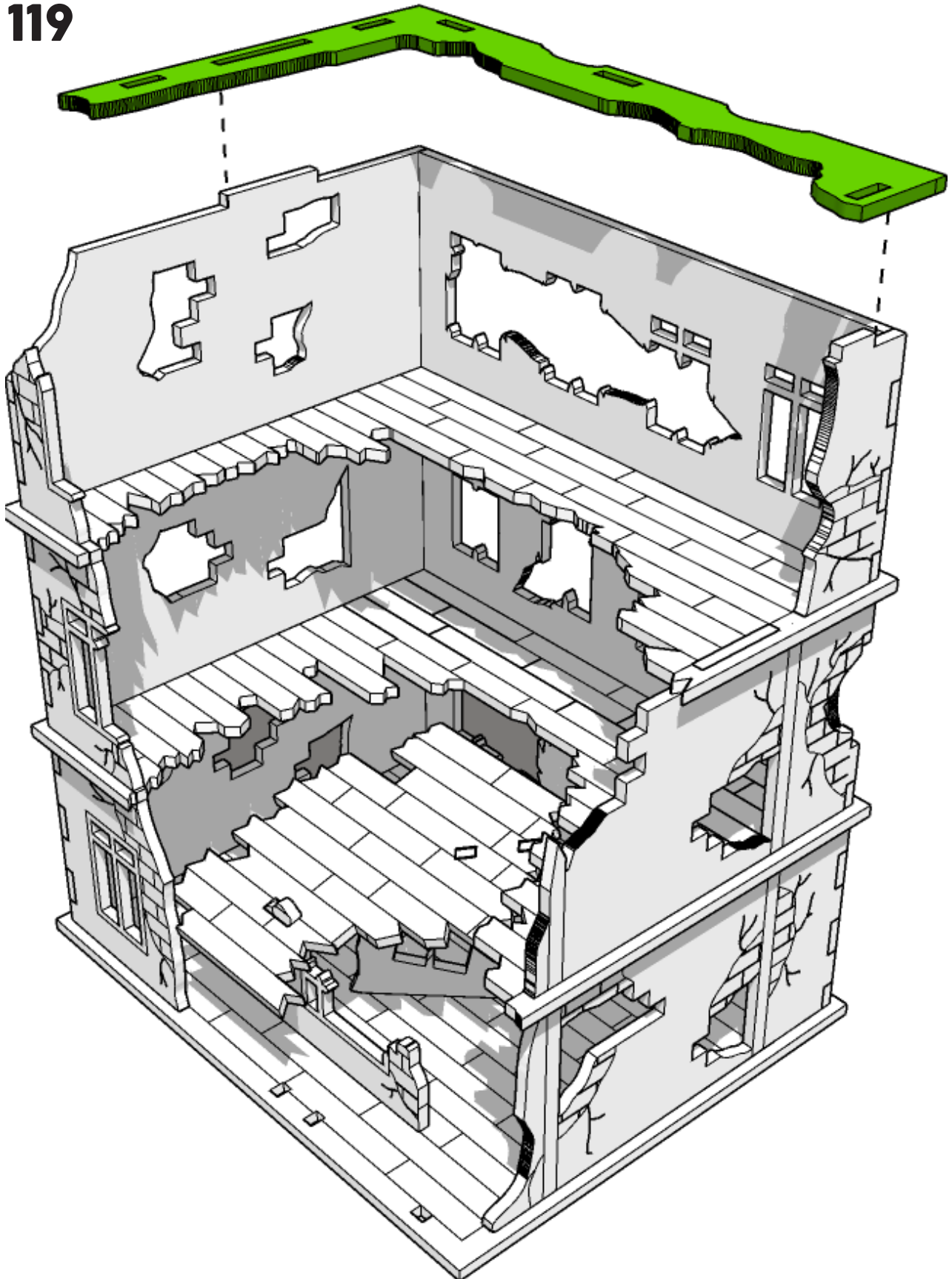





# TABLETOP SCENICS

120

TTSC-WAR-O83  
City, Corner & Delapidated  
Rowhouse Destroyed

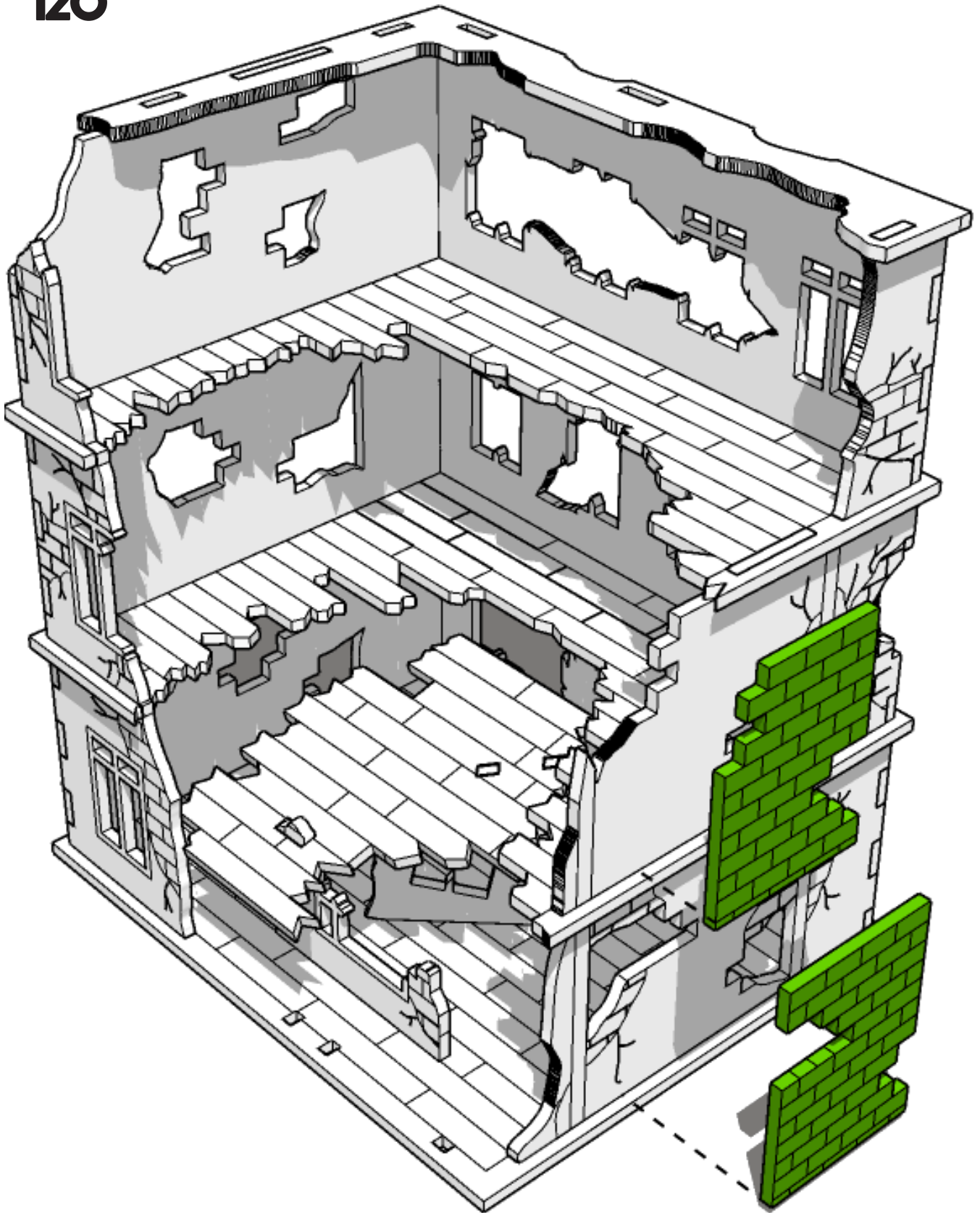



# TABLETOP SCENICS

121

TTSC-WAR-O83  
City, Corner & Delapidated  
Rowhouse Destroyed

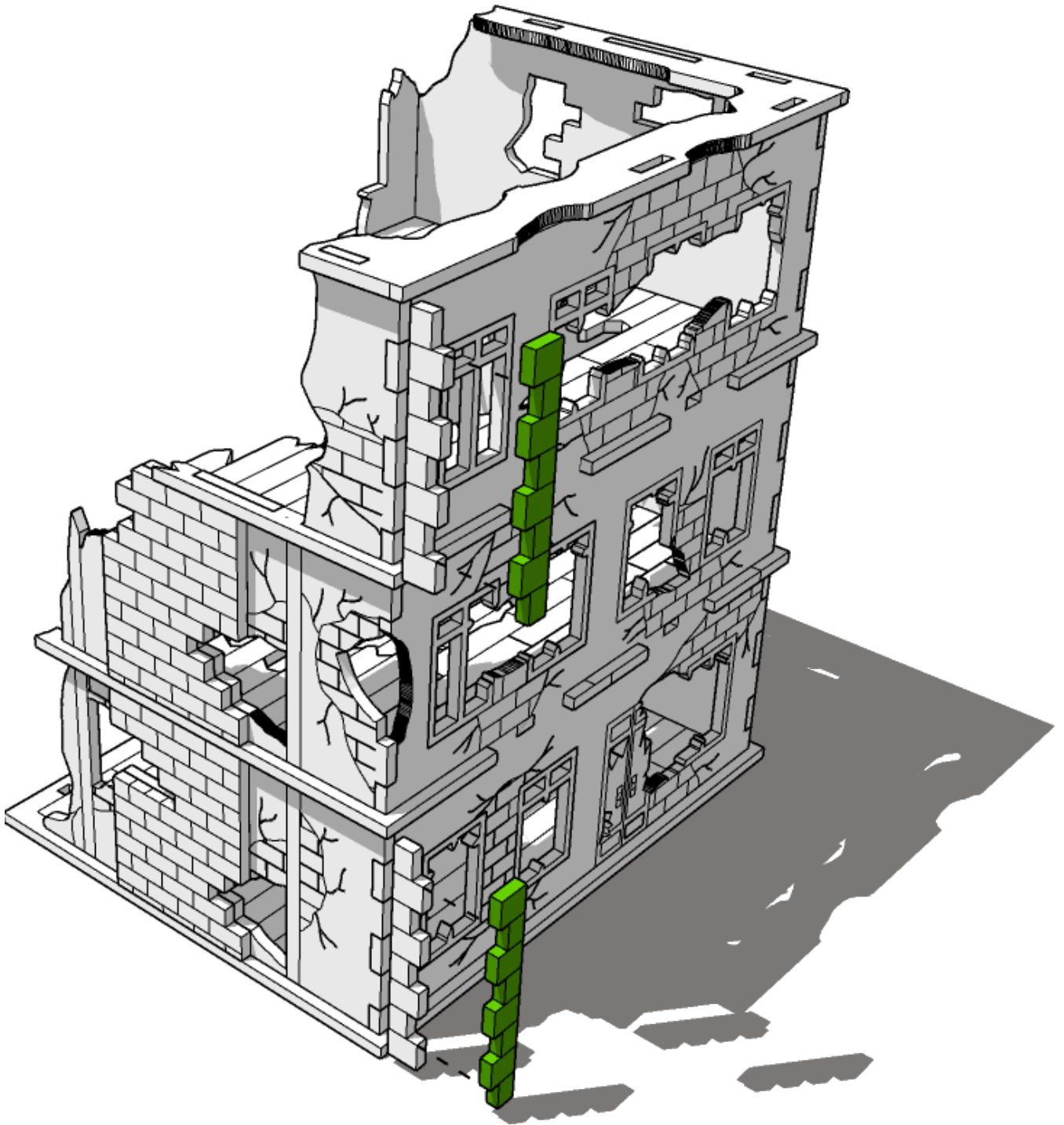



# TABLETOP SCENICS

122

TTSC-WAR-O83  
City, Corner & Delapidated  
Rowhouse Destroyed

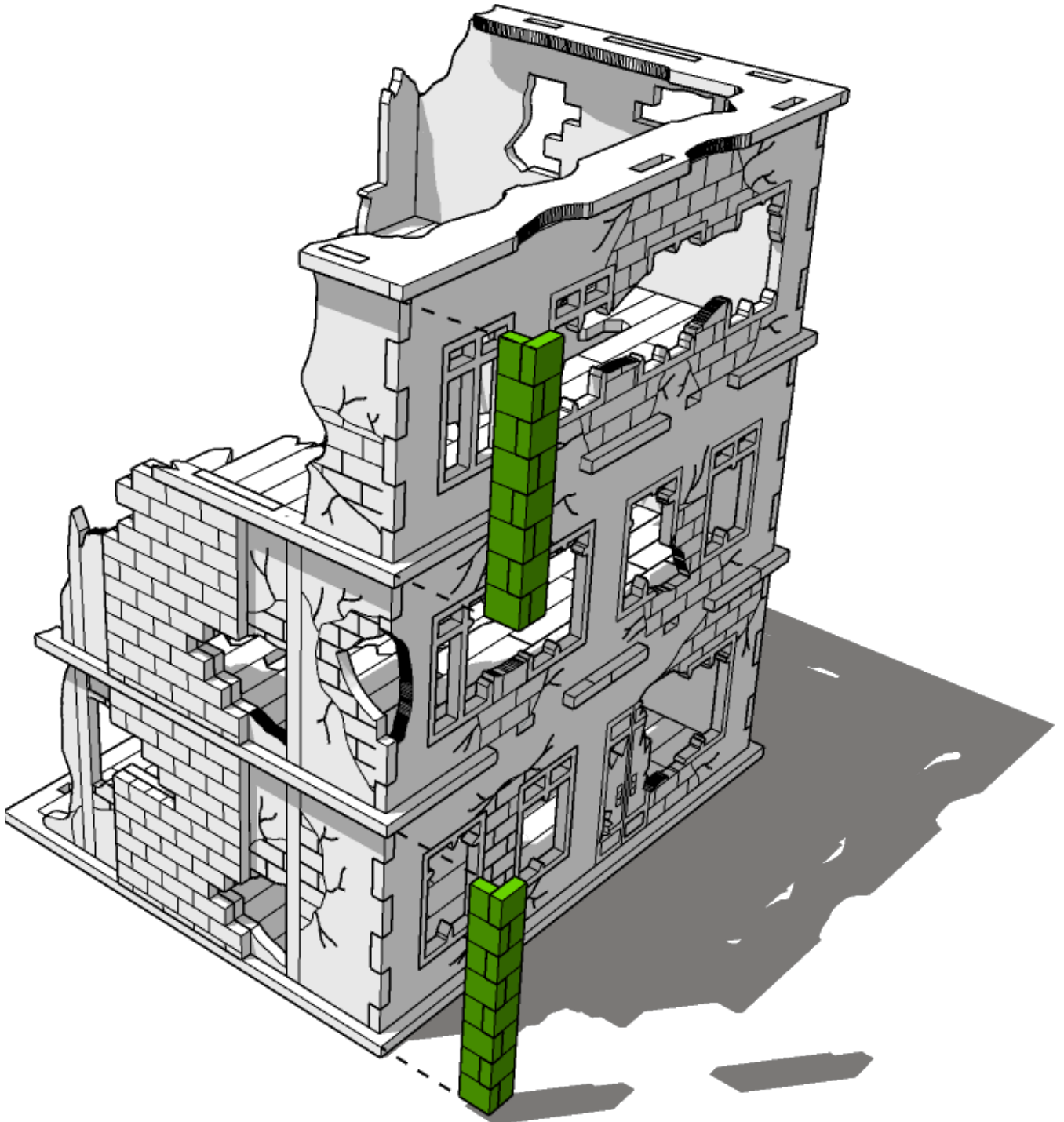



# TABLETOP SCENICS

123

TTSC-WAR-O83  
City, Corner & Delapidated  
Rowhouse Destroyed

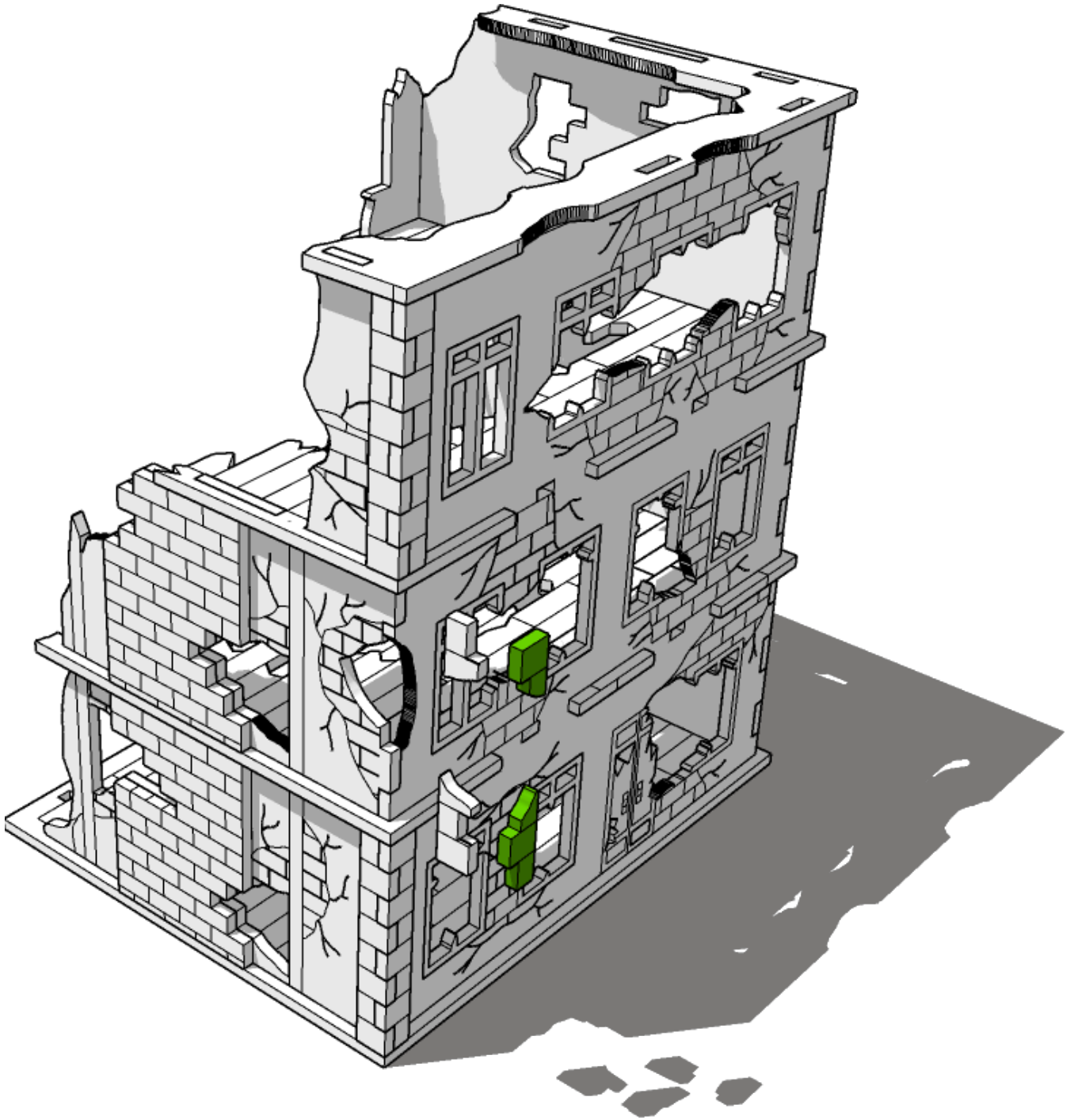



# TABLETOP SCENICS

124

TTSC-WAR-083  
City, Corner & Delapidated  
Rowhouse Destroyed

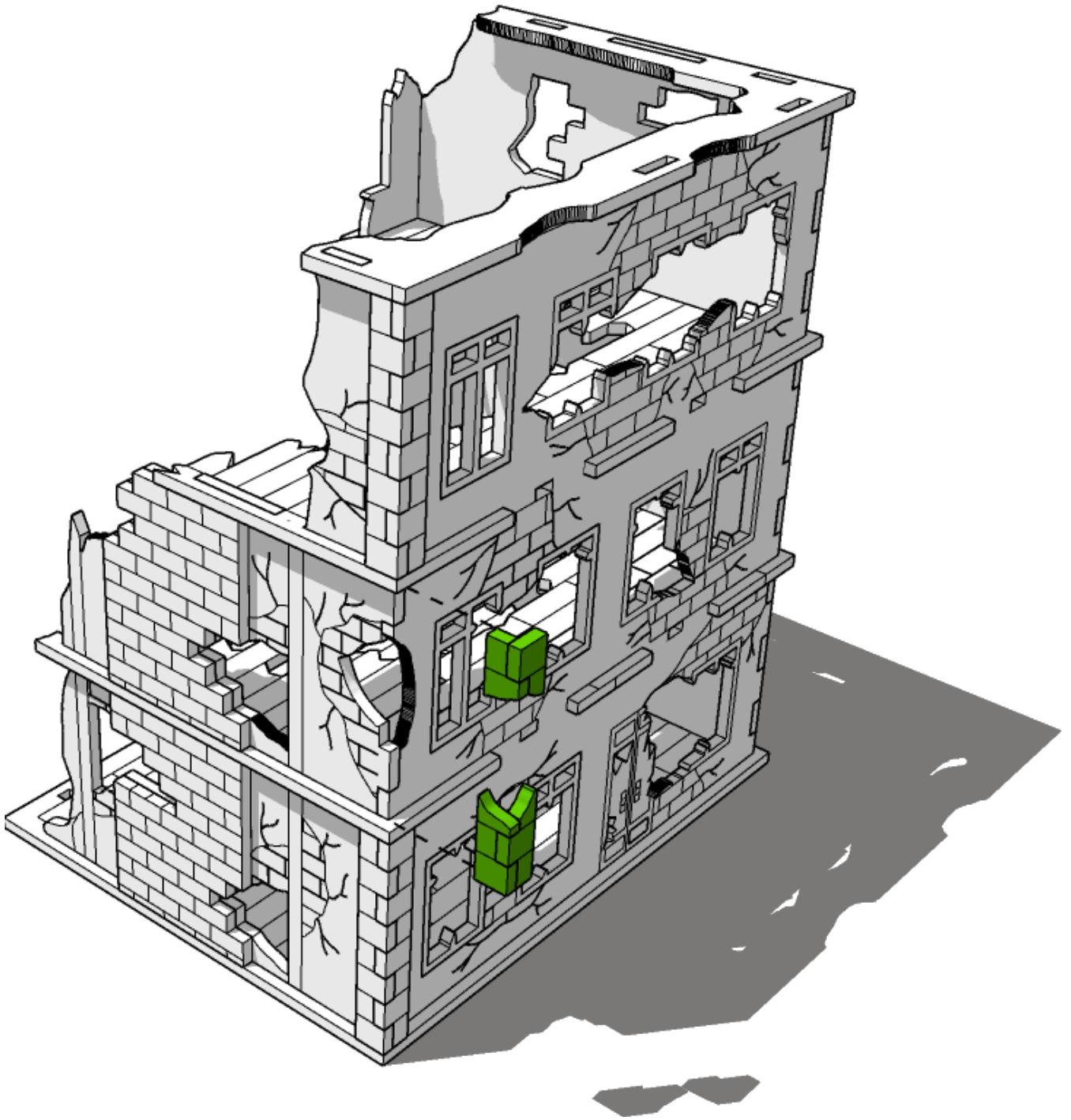



# TABLETOP SCENICS

125

TTSC-WAR-083  
City, Corner & Delapidated  
Rowhouse Destroyed

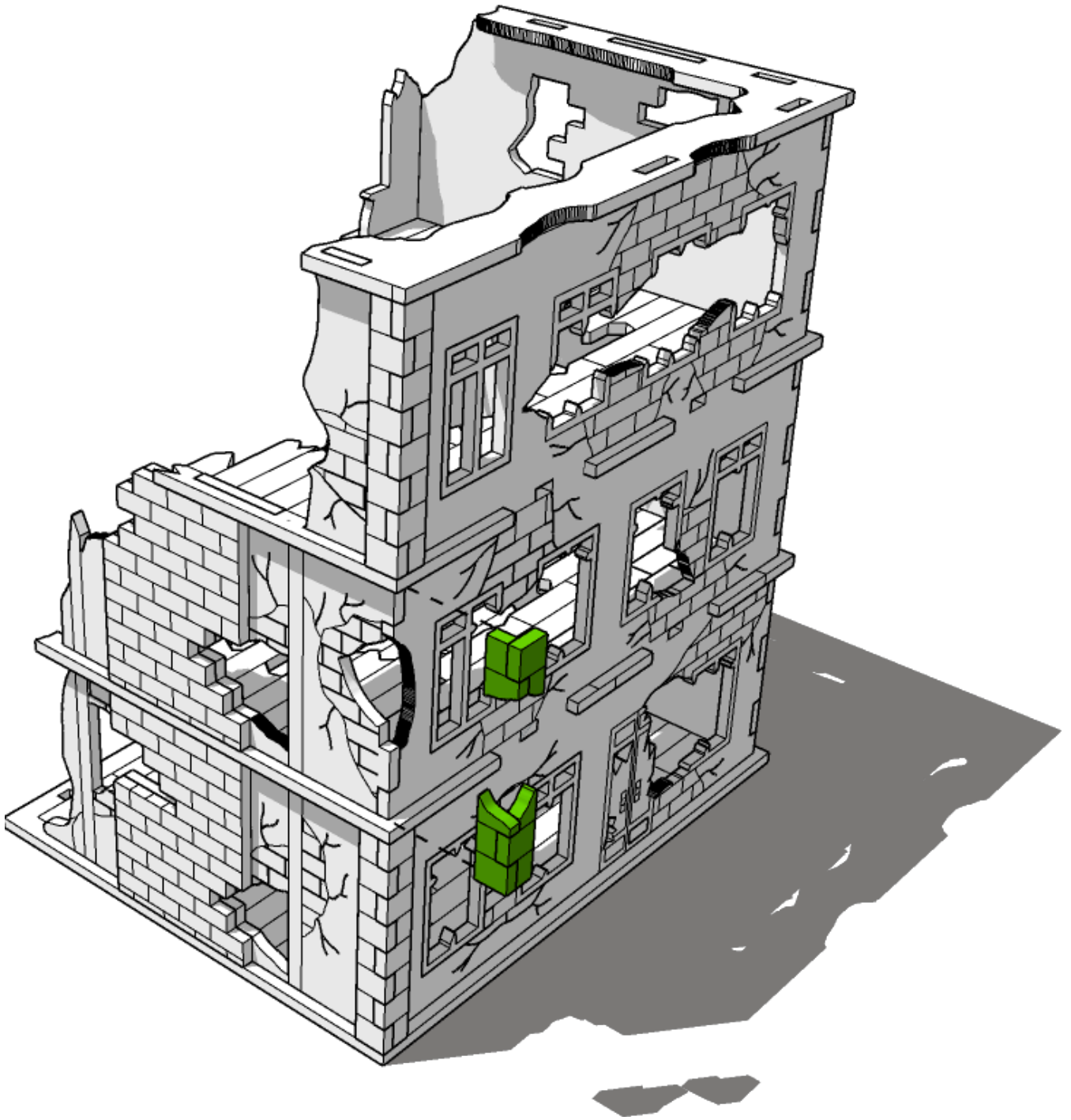



# TABLETOP SCENICS

126

TTSC-WAR-O83  
City, Corner & Delapidated  
Rowhouse Destroyed

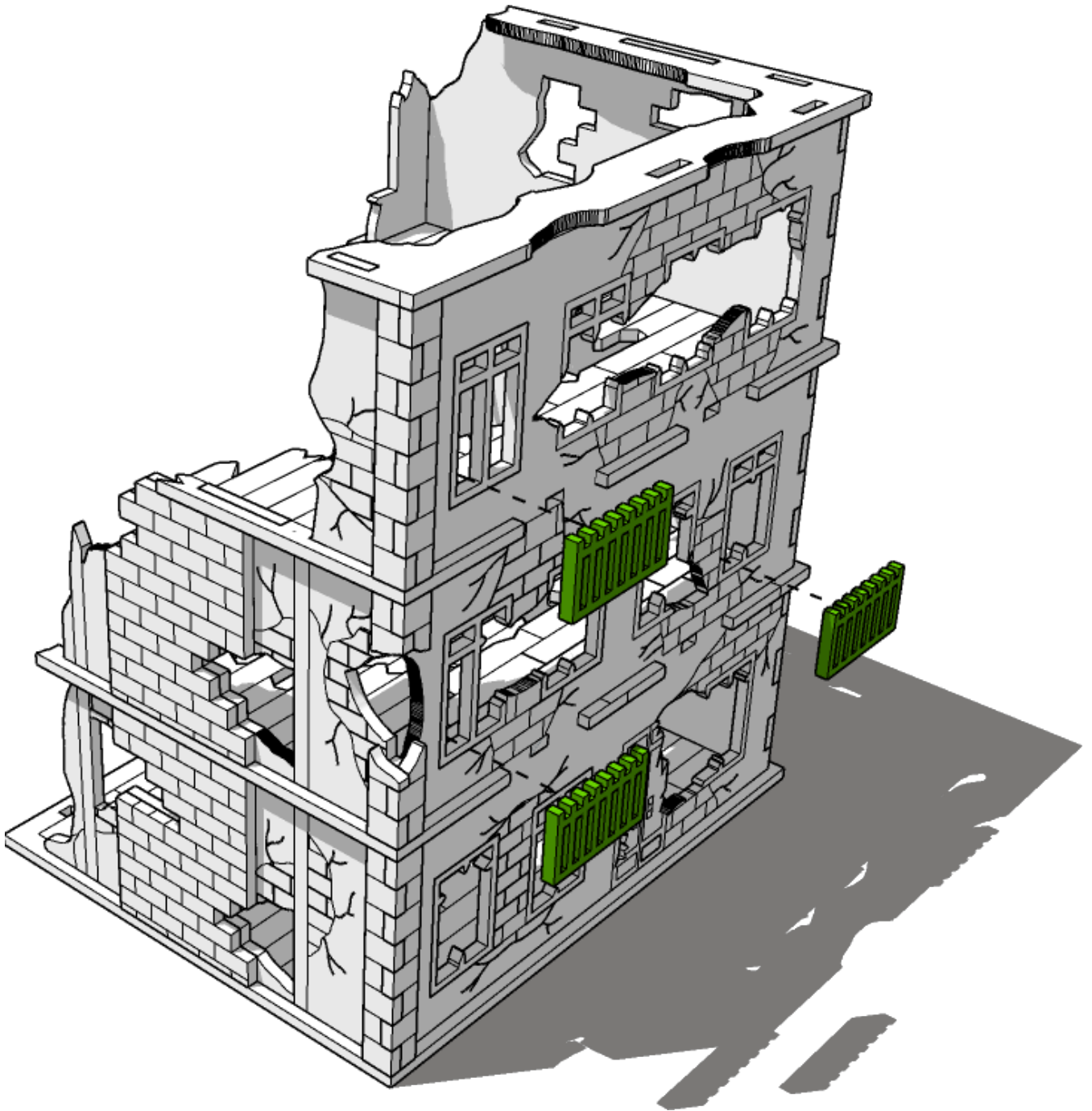



# TABLETOP SCENICS

127

TTSC-WAR-O83  
City, Corner & Delapidated  
Rowhouse Destroyed

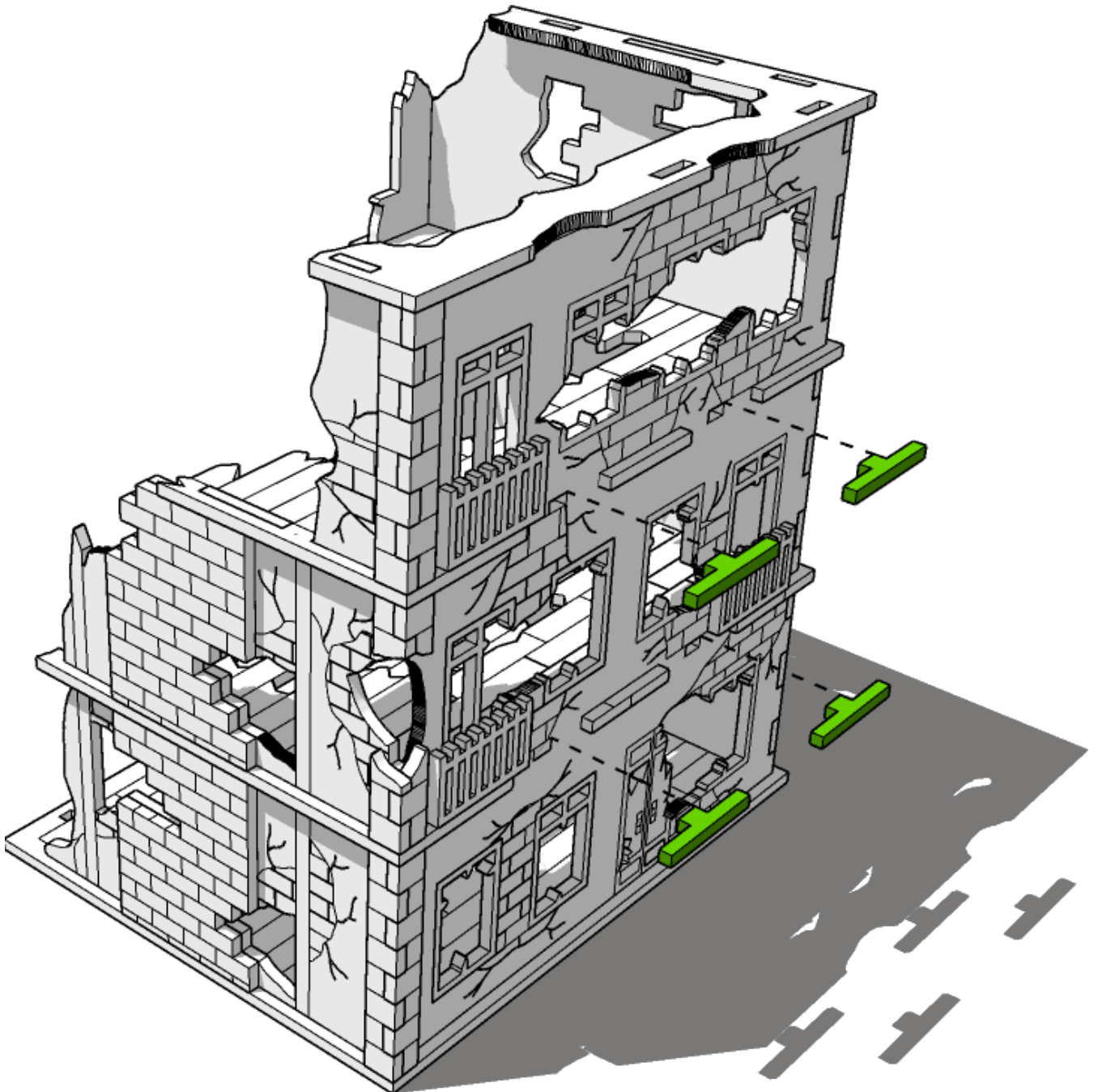





# TABLETOP SCENICS

128

TTSC-WAR-O83  
City, Corner & Delapidated  
Rowhouse Destroyed

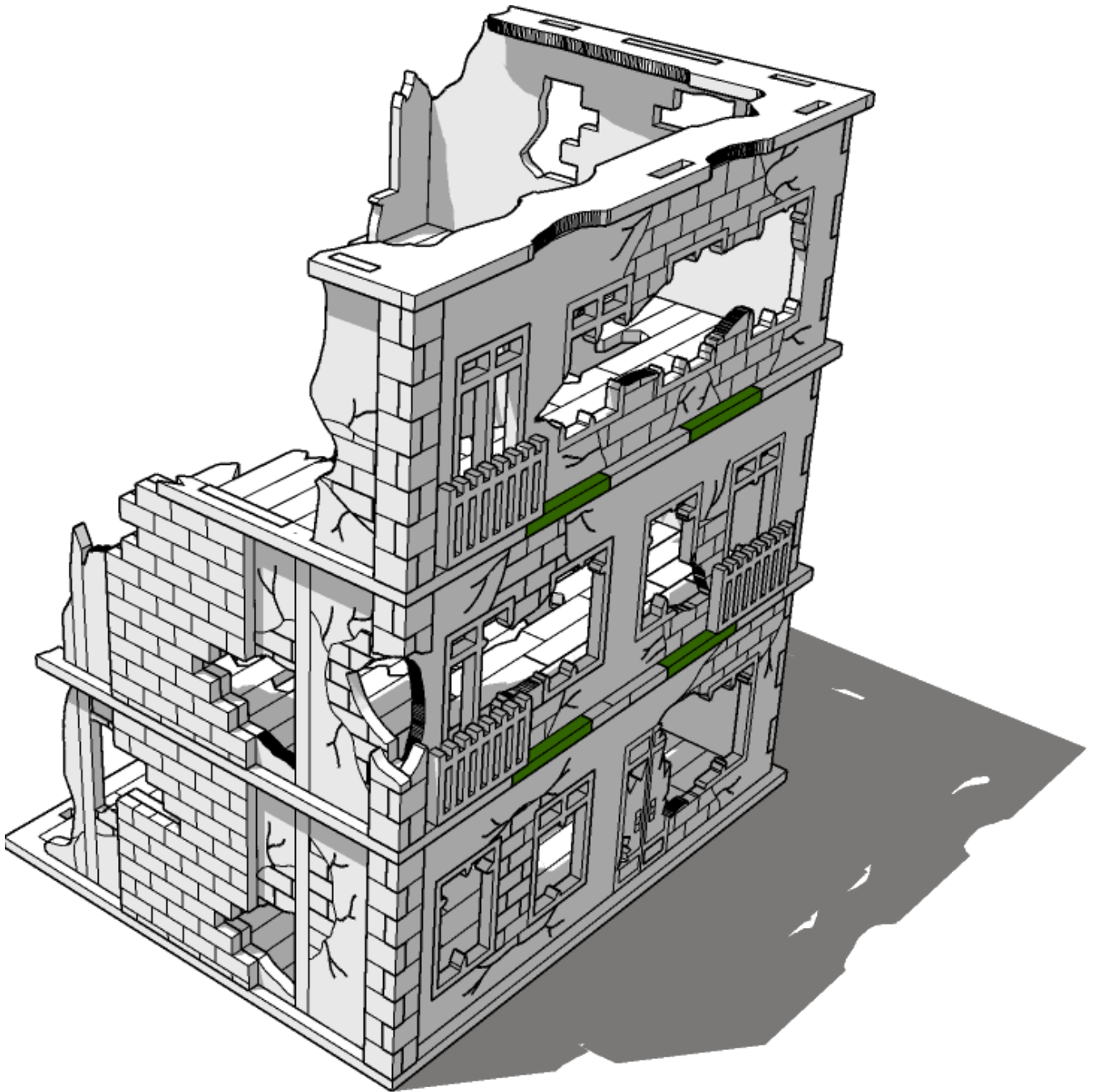



# TABLETOP SCENICS

129

TTSC-WAR-O83  
City, Corner & Delapidated  
Rowhouse Destroyed

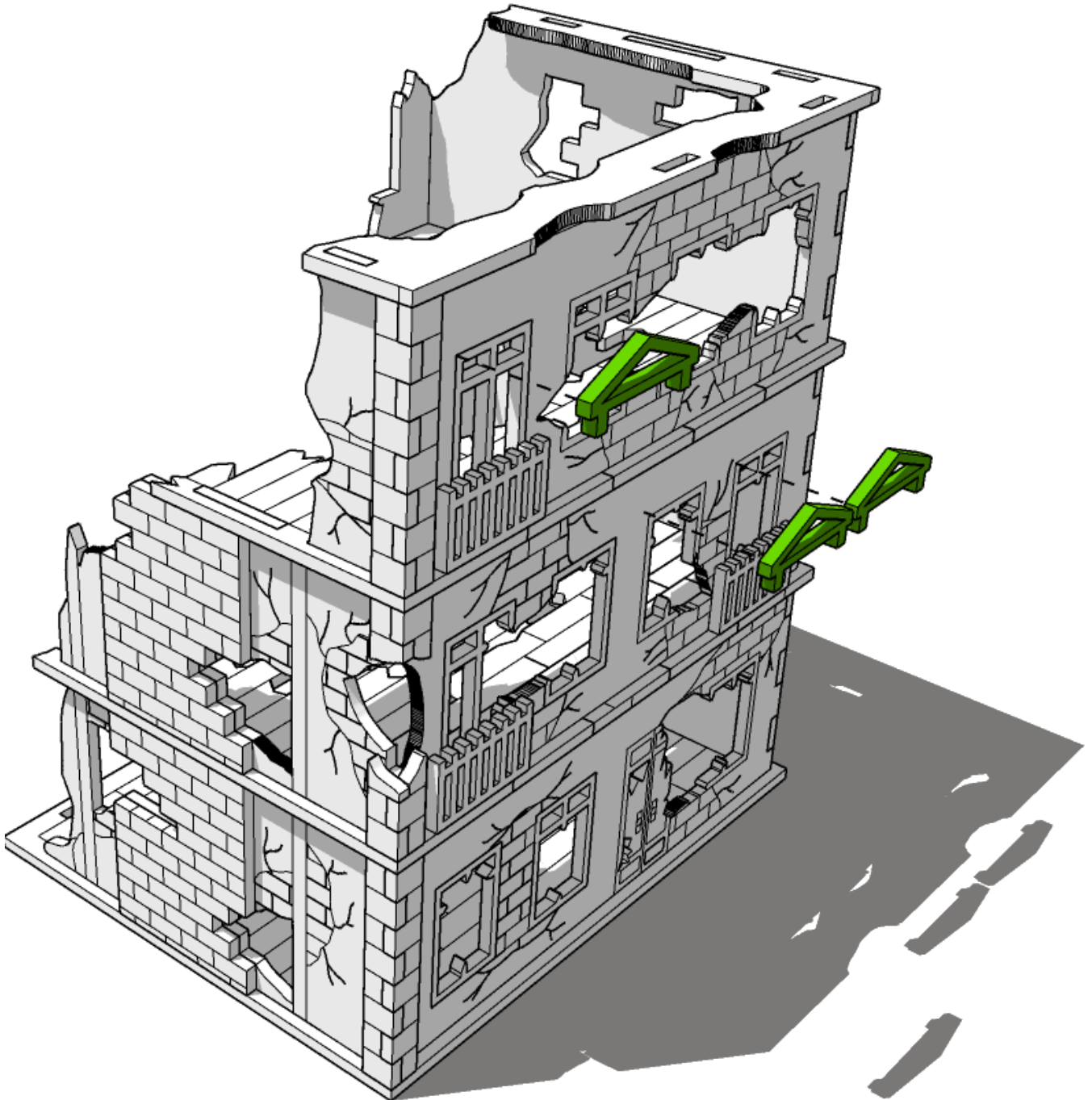



# TABLETOP SCENICS

130

TTSC-WAR-083  
City, Corner & Delapidated  
Rowhouse Destroyed

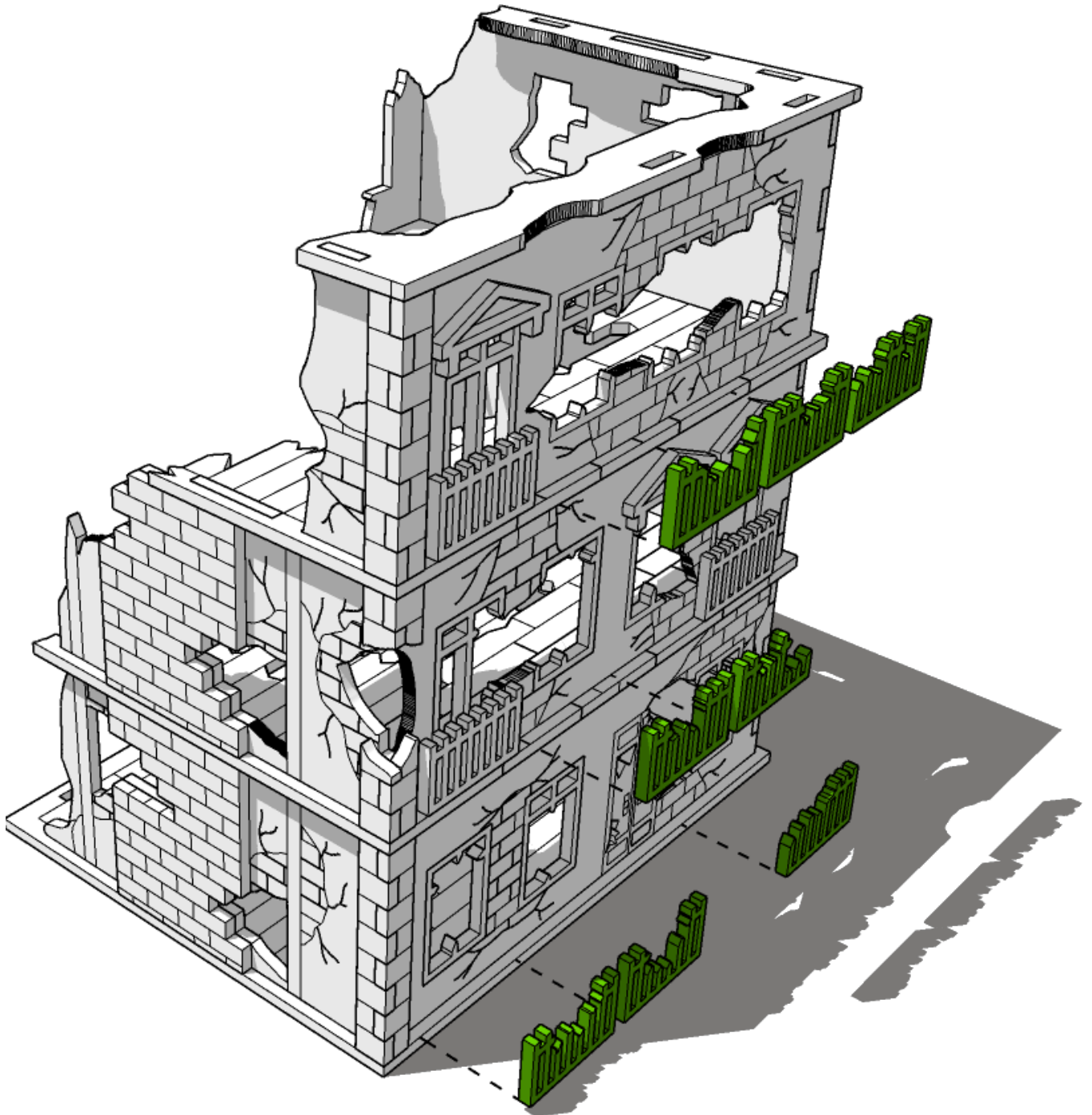



# TABLETOP SCENICS

**TTSC-WAR-O83**  
**City, Corner & Delapidated**  
**Rowhouse Destroyed**

**131**

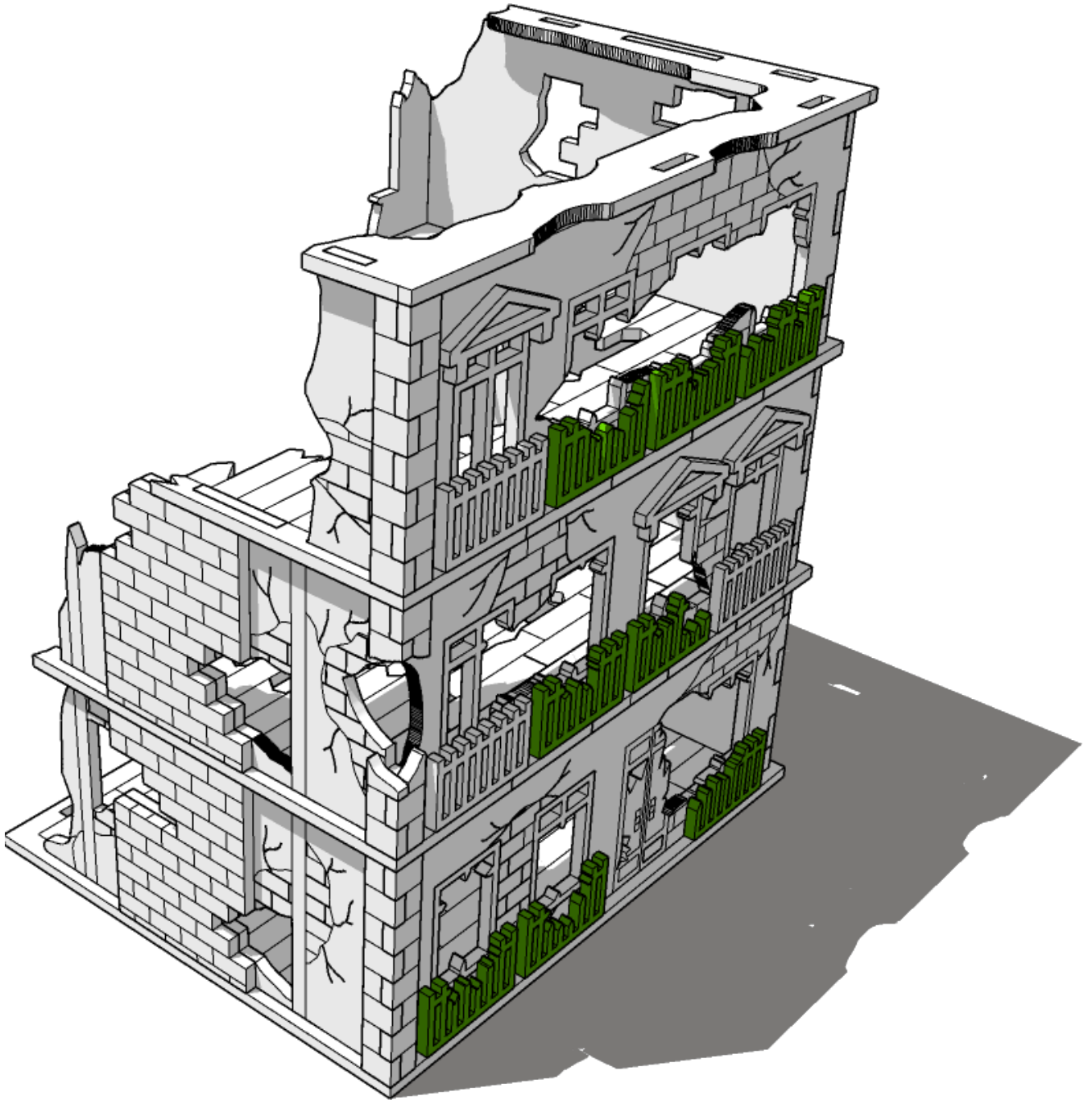



# TABLETOP SCENICS

TTSC-WAR-O83  
City, Corner & Delapidated  
Rowhouse Destroyed

132

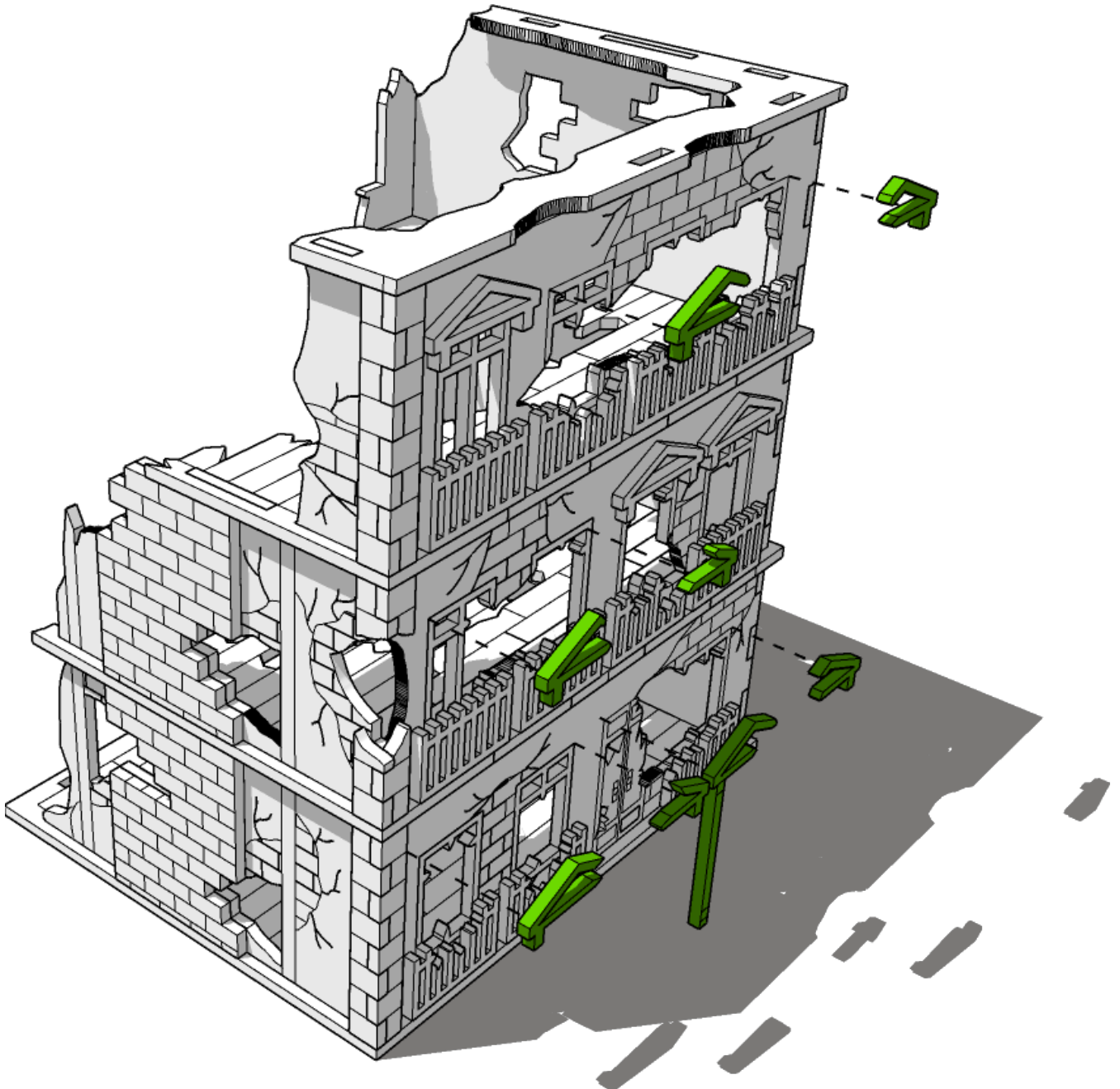



# TABLETOP SCENICS

133

TTSC-WAR-O83  
City, Corner & Delapidated  
Rowhouse Destroyed

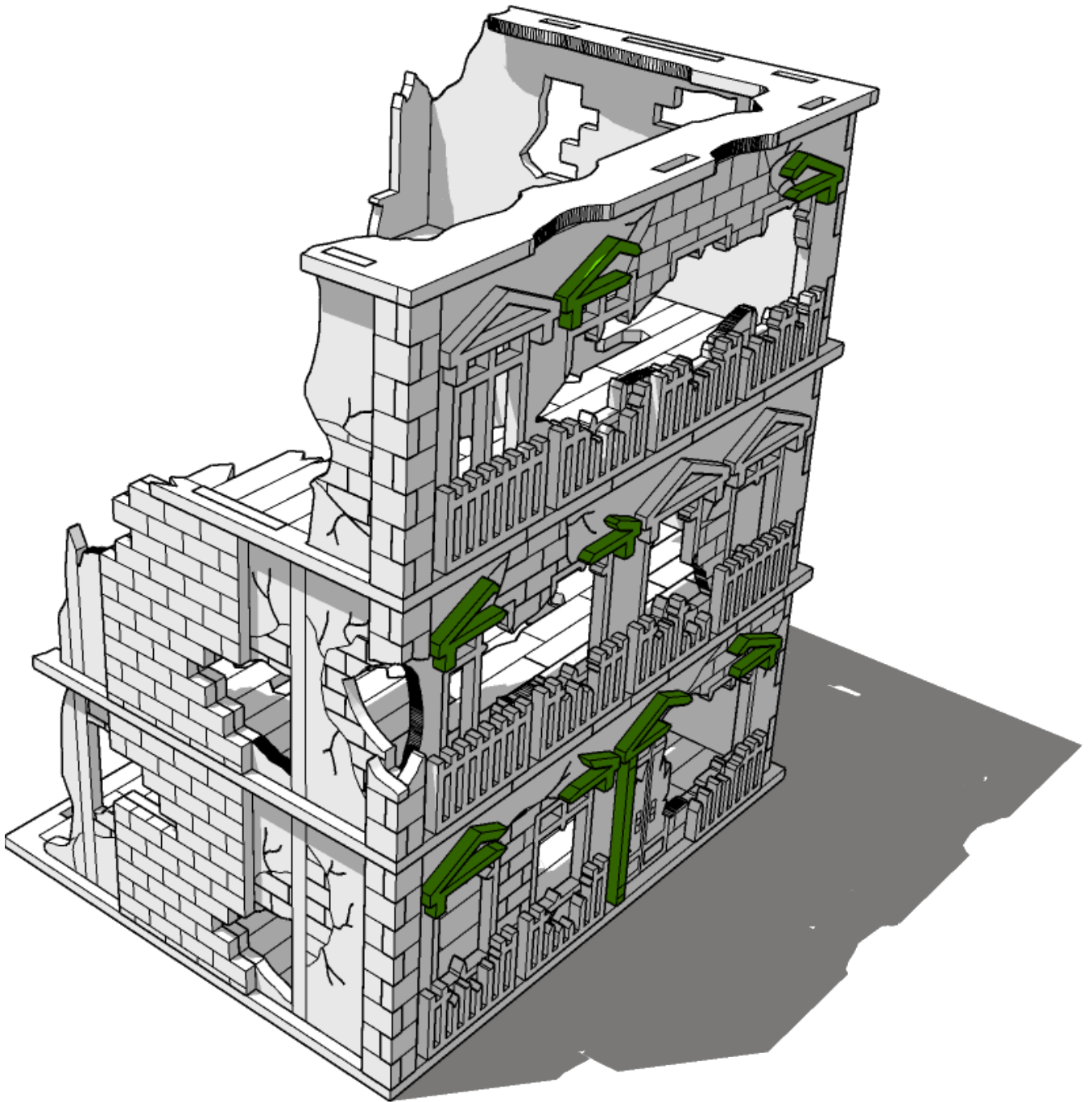



# TABLETOP SCENICS

**TTSC-WAR-083**  
**City, Corner & Delapidated**  
**Rowhouse Destroyed**

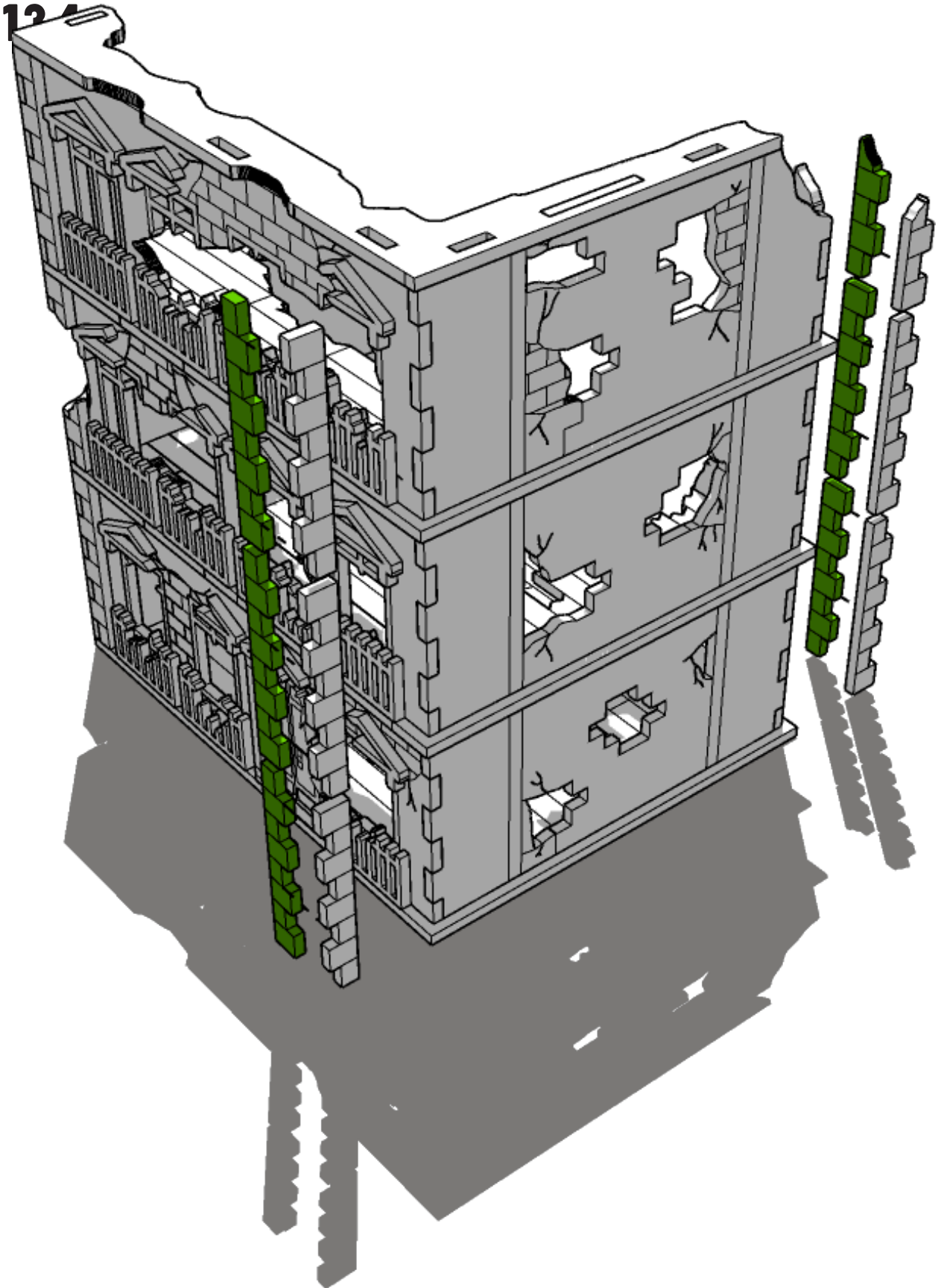



TABLETOP  
**SCENICS**

**TTSC-WAR-083**  
**City, Corner & Delapidated**  
**Rowhouse Destroyed**

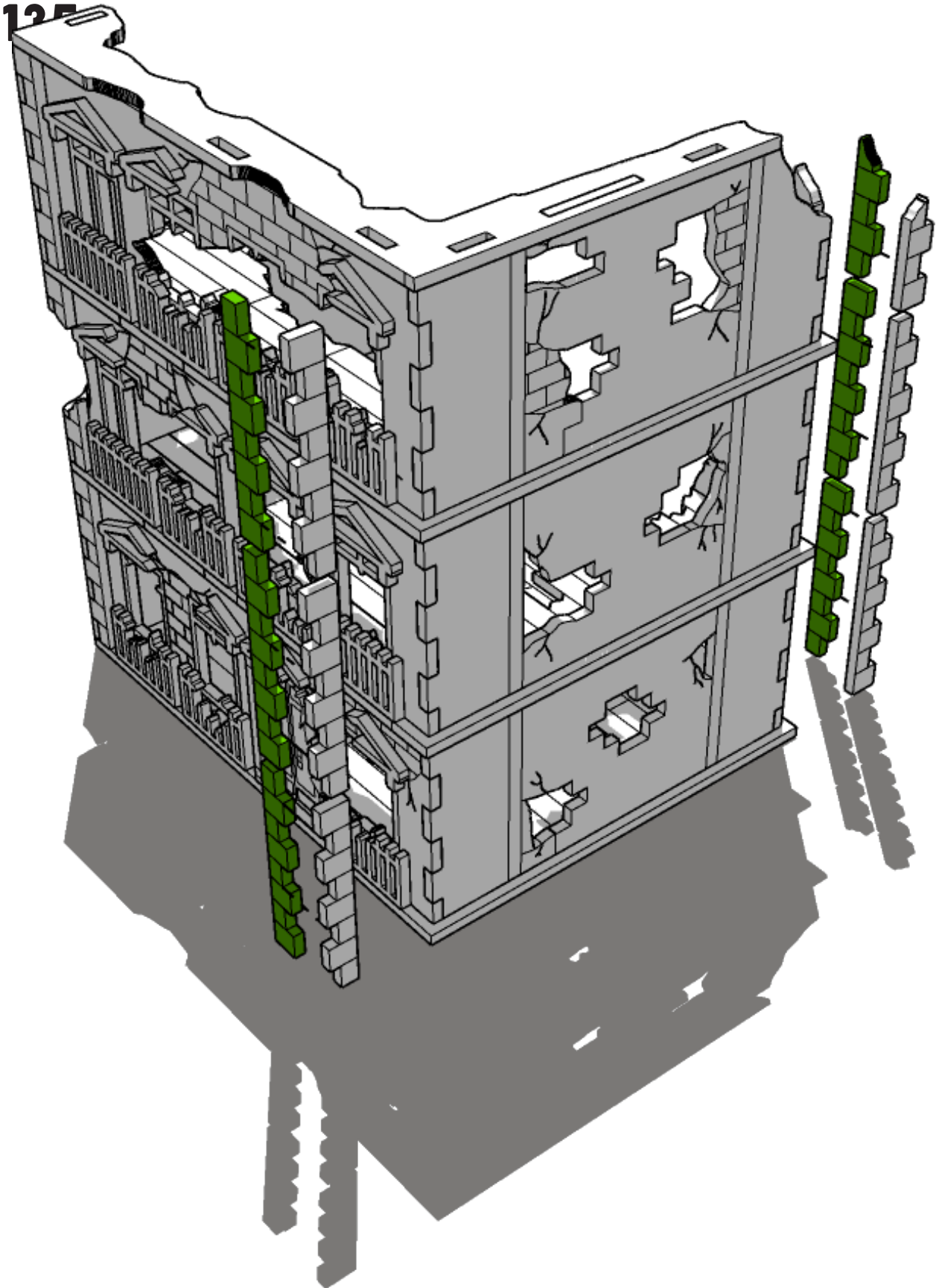





# TABLETOP SCENICS

**TTSC-WAR-083**  
**City, Corner & Delapidated**  
**Rowhouse Destroyed**

134





TABLETOP  
**SCENICS**

**137**

**TTSC-WAR-O83**  
**City, Corner & Delapidated**  
**Rowhouse Destroyed**

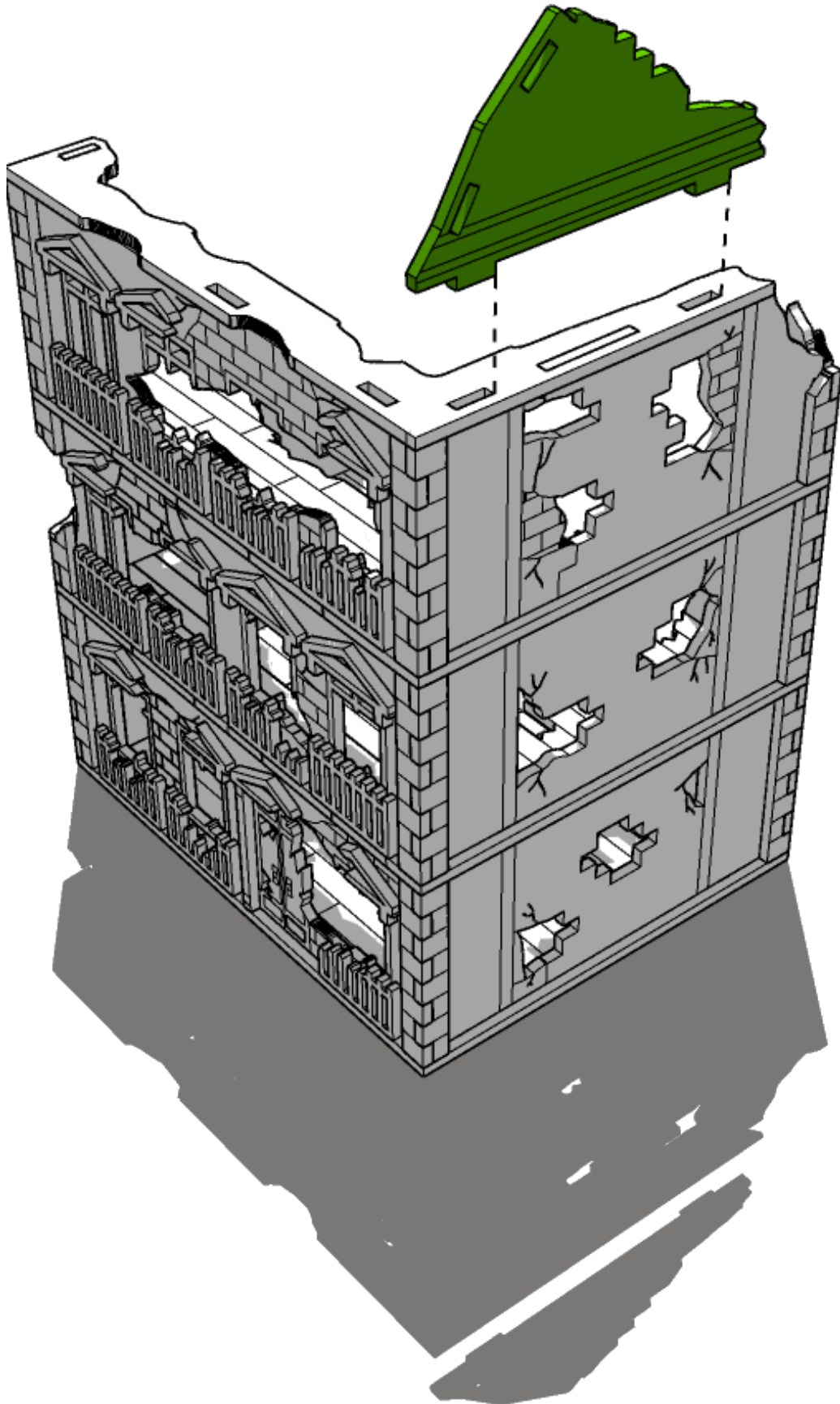



# TABLETOP SCENICS

**TTSC-WAR-083**  
**City, Corner & Delapidated**  
**Rowhouse Destroyed**

**138**





# TABLETOP SCENICS

TTSC-WAR-O83  
City, Corner & Delapidated  
Rowhouse Destroyed

139

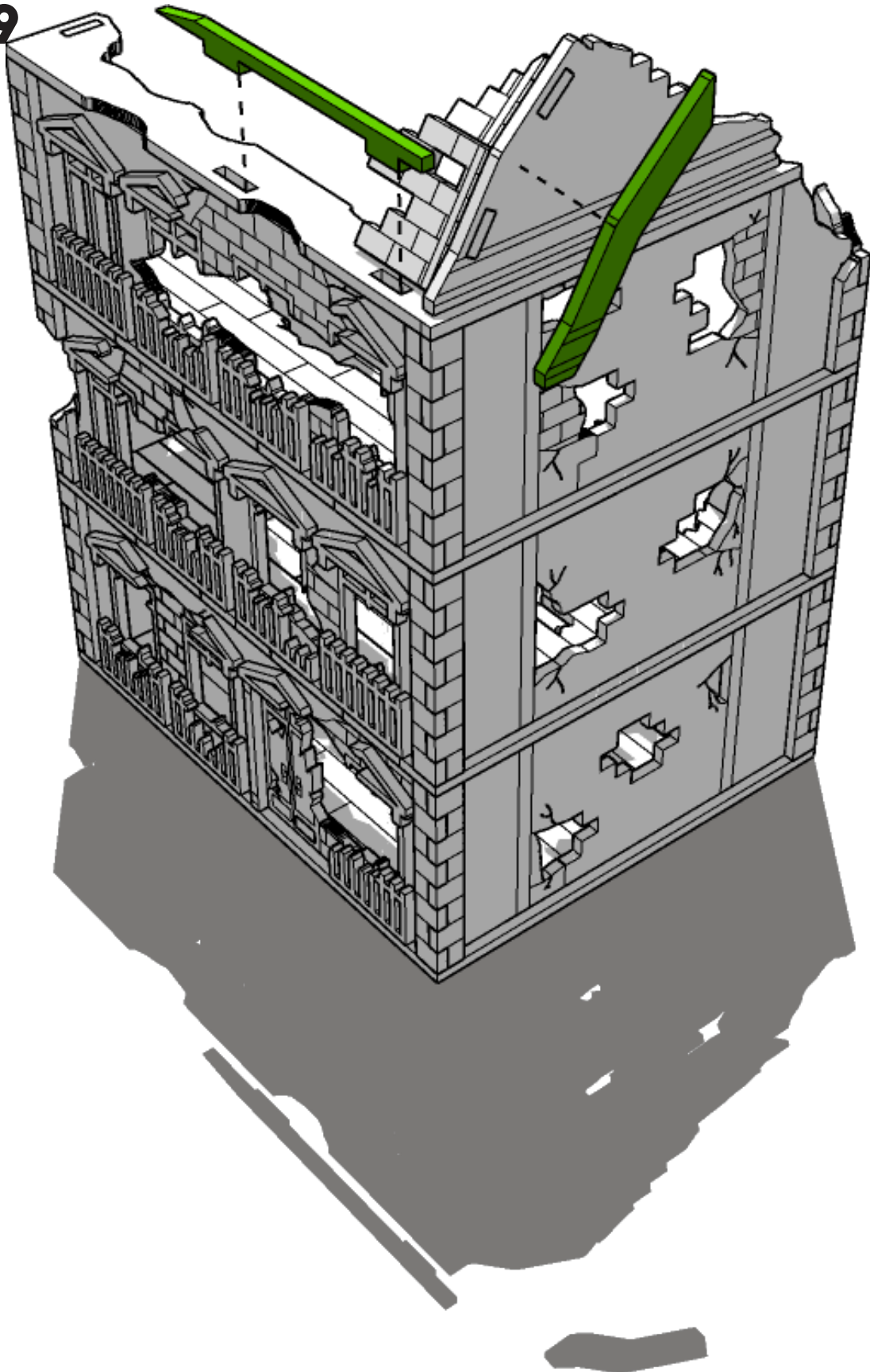



# TABLETOP SCENICS

TTSC-WAR-O83  
City, Corner & Delapidated  
Rowhouse Destroyed

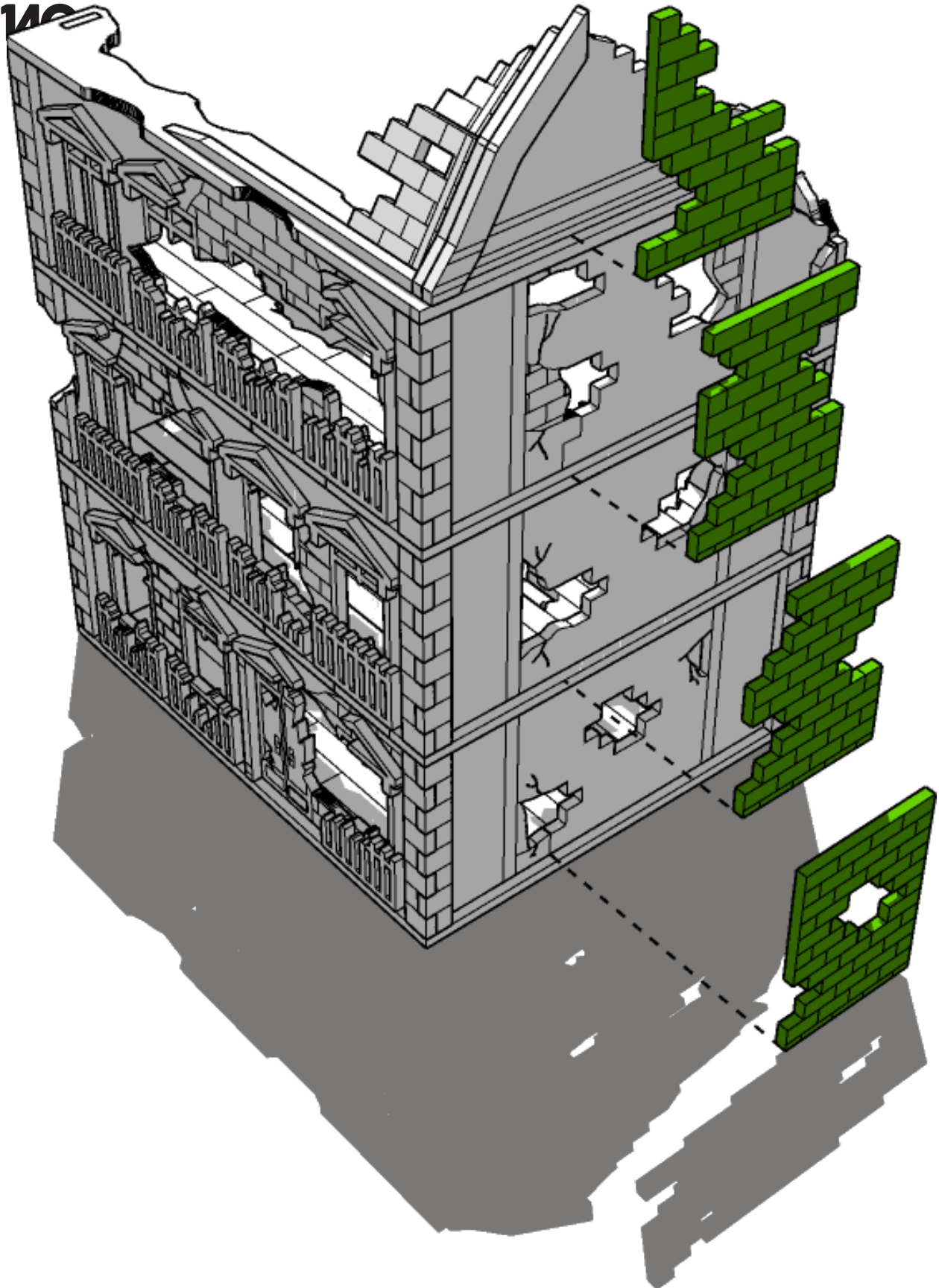



# TABLETOP SCENICS

TTSC-WAR-O83  
City, Corner & Delapidated  
Rowhouse Destroyed

141

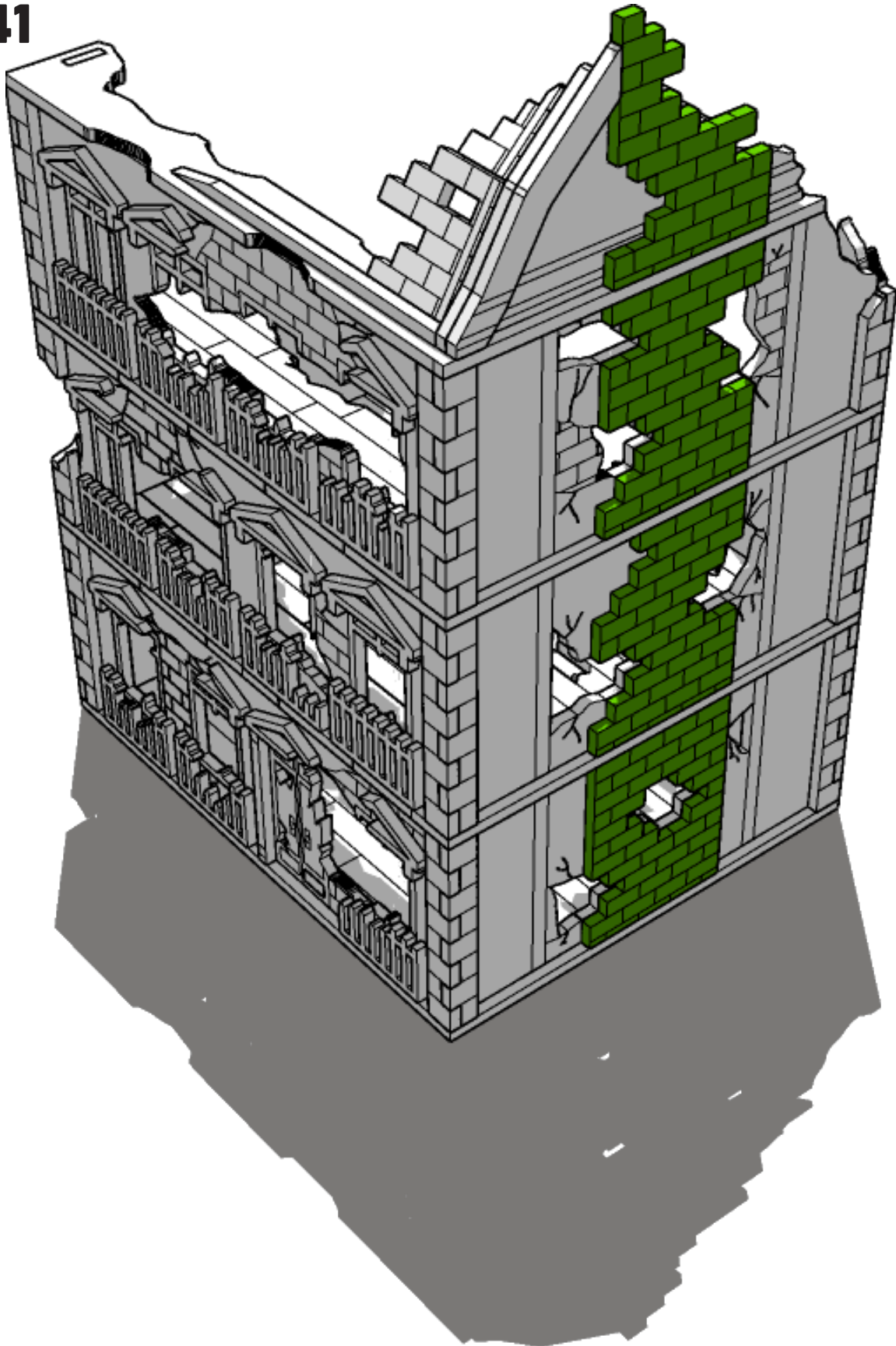



# TABLETOP SCENICS

**TTSC-WAR-083**  
**City, Corner & Delapidated**  
**Rowhouse Destroyed**

**142**

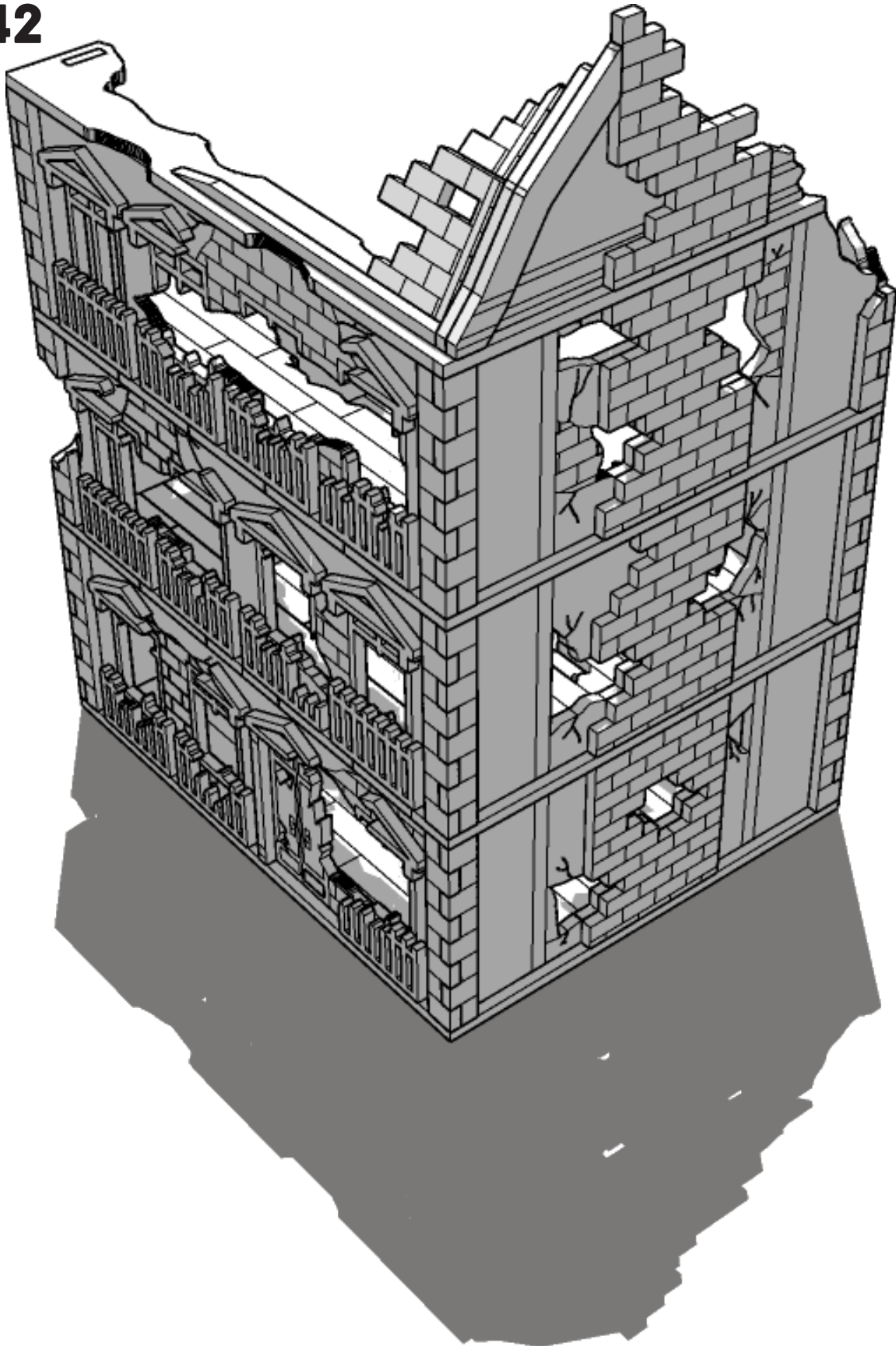



# TABLETOP SCENICS

TTSC-WAR-083  
City, Corner & Delapidated  
Rowhouse Destroyed

143

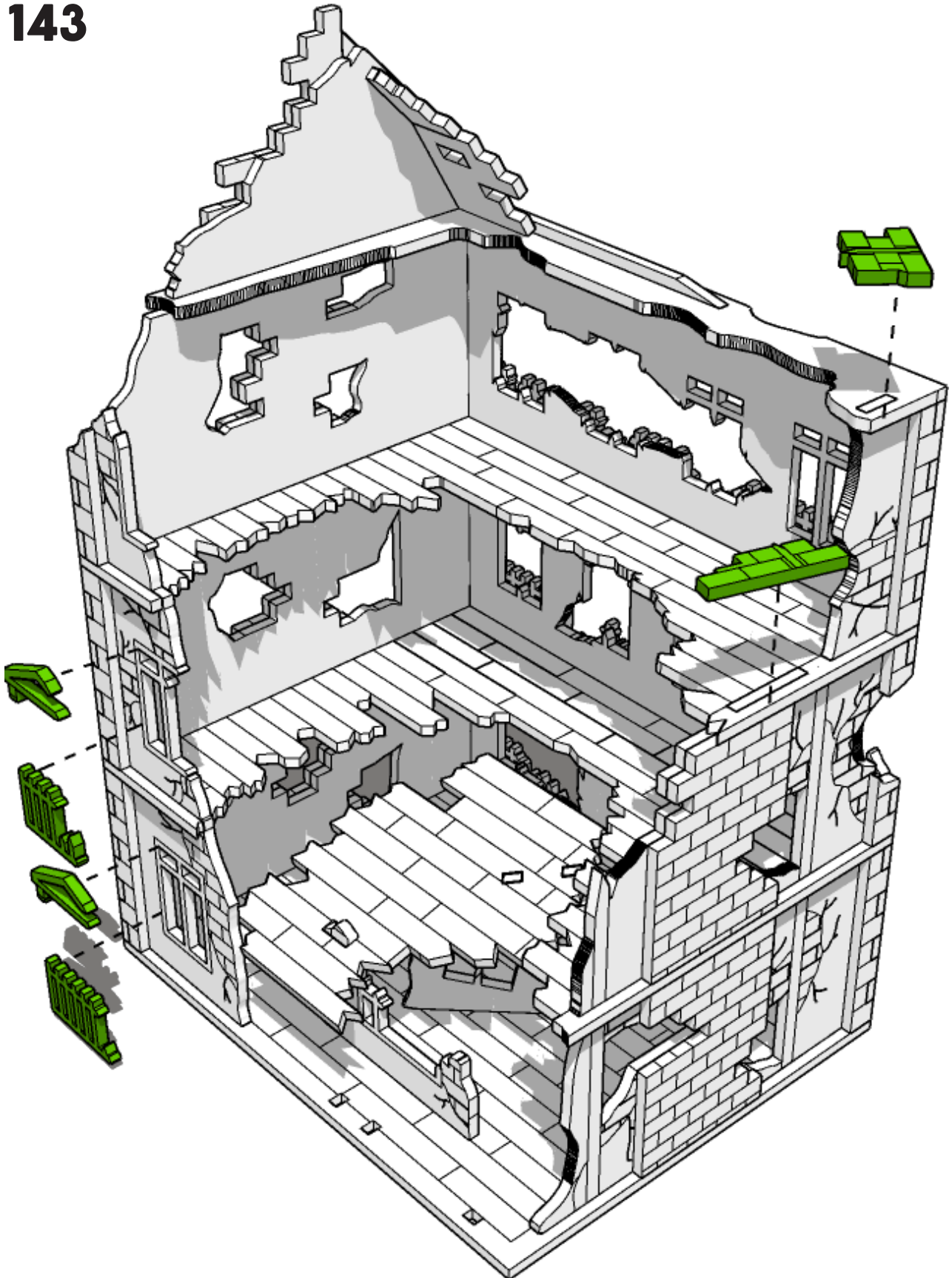





# TABLETOP SCENICS

TTSC-WAR-083  
City, Corner & Delapidated  
Rowhouse Destroyed

144

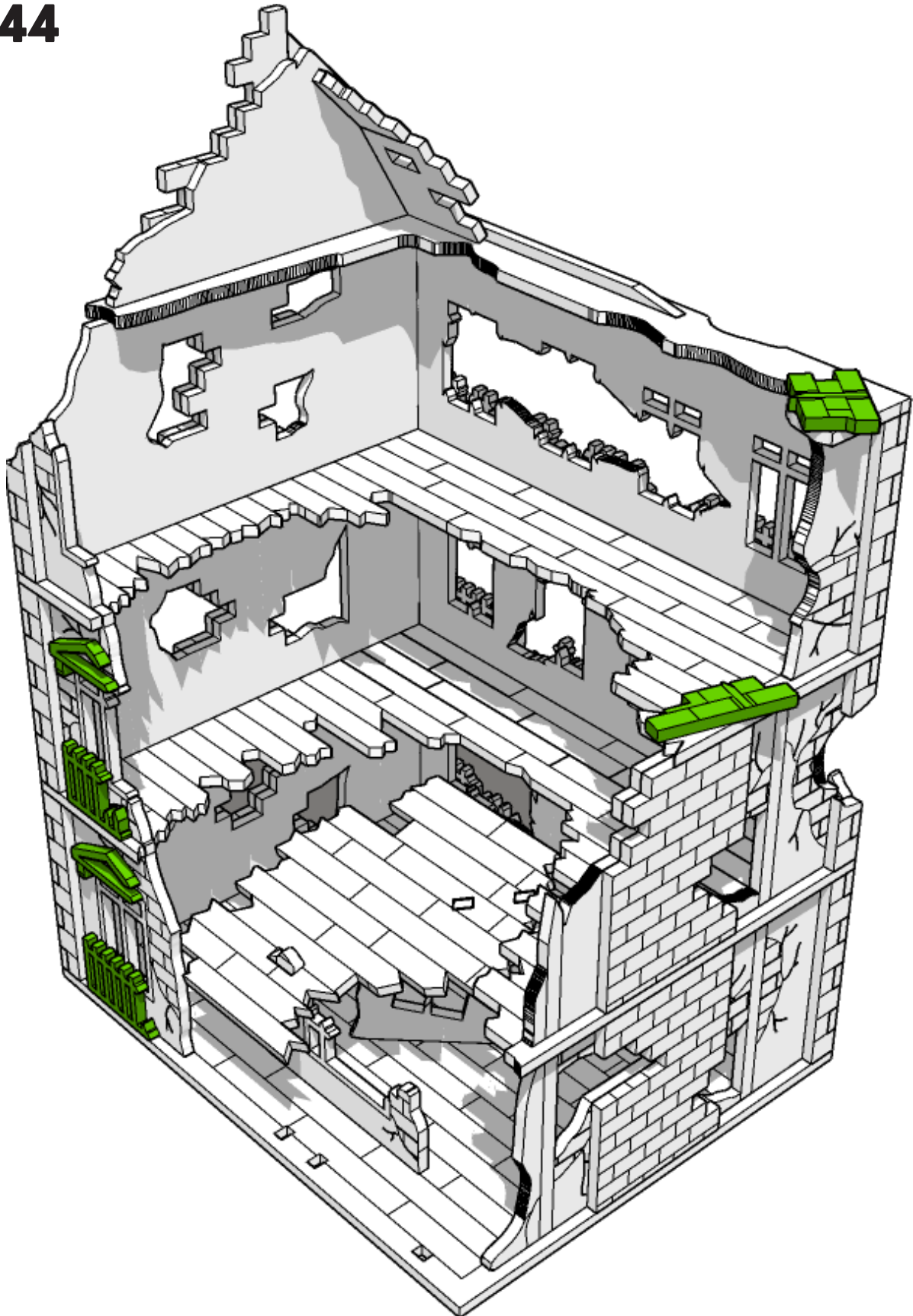



# TABLETOP SCENICS

**TTSC-WAR-083**  
**City, Corner & Delapidated**  
**Rowhouse Destroyed**

**145**

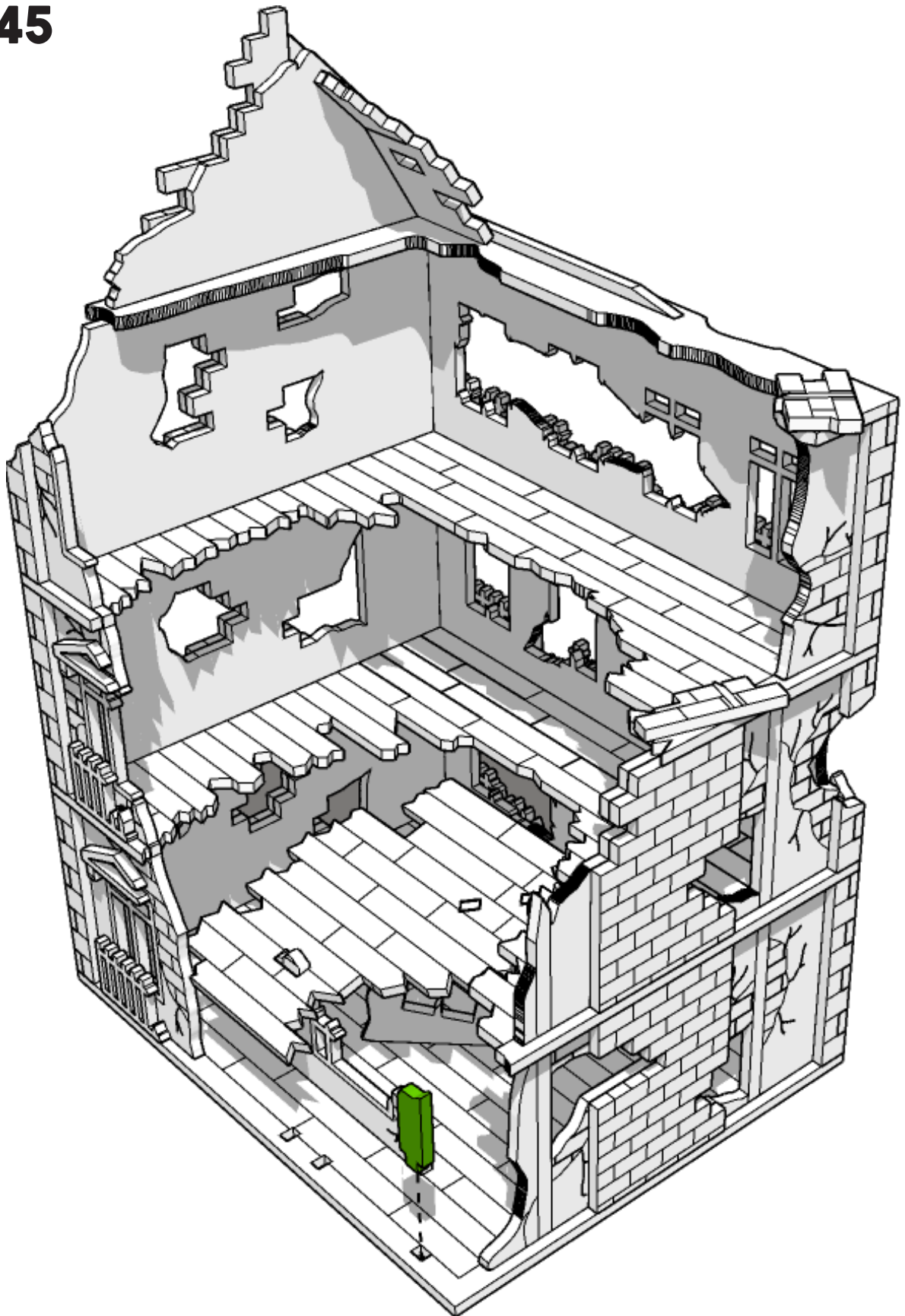



# TABLETOP SCENICS

**TTSC-WAR-O83**  
**City, Corner & Delapidated**  
**Rowhouse Destroyed**

**146**

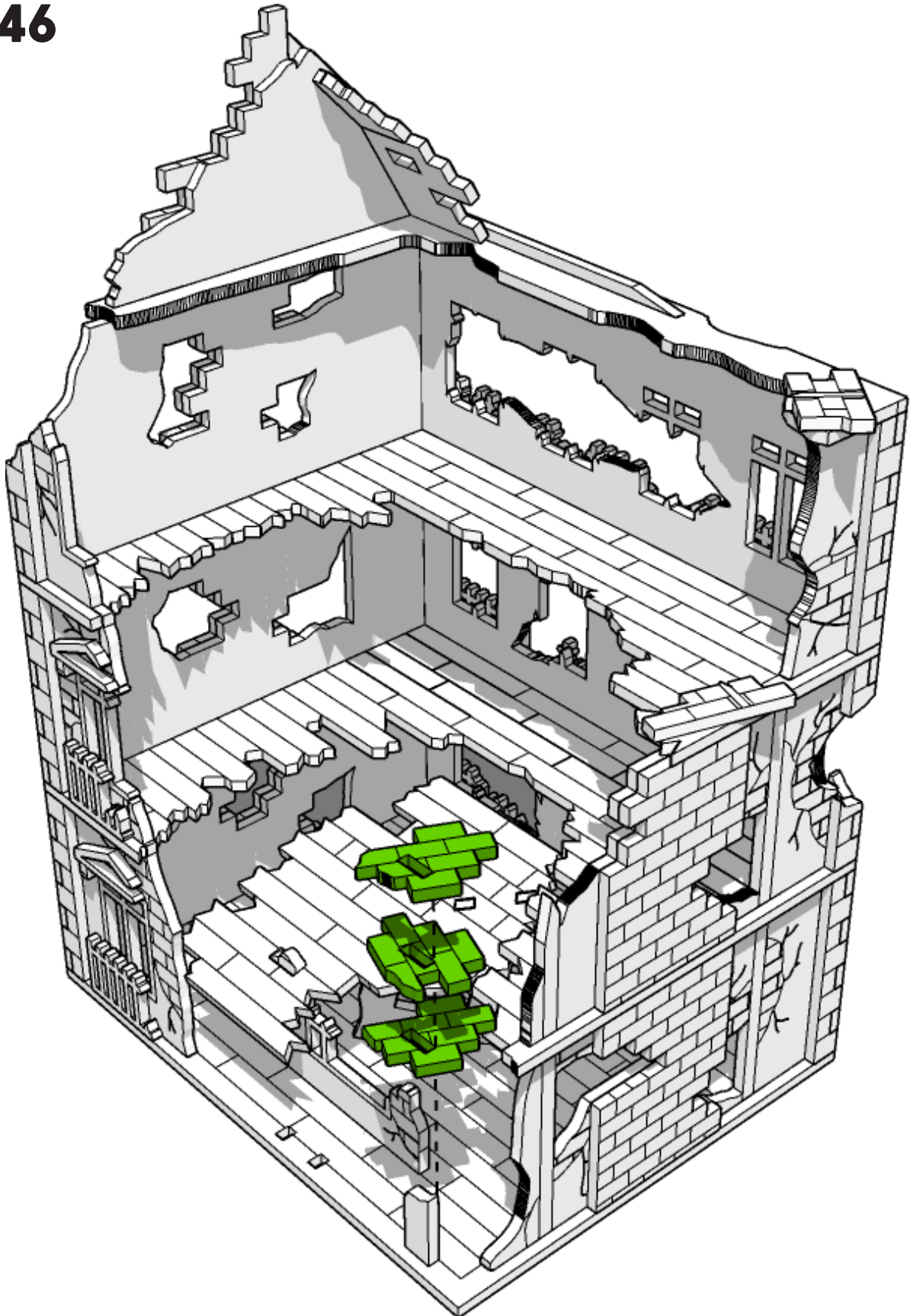



# TABLETOP SCENICS

**TTSC-WAR-083**  
**City, Corner & Delapidated**  
**Rowhouse Destroyed**

**147**

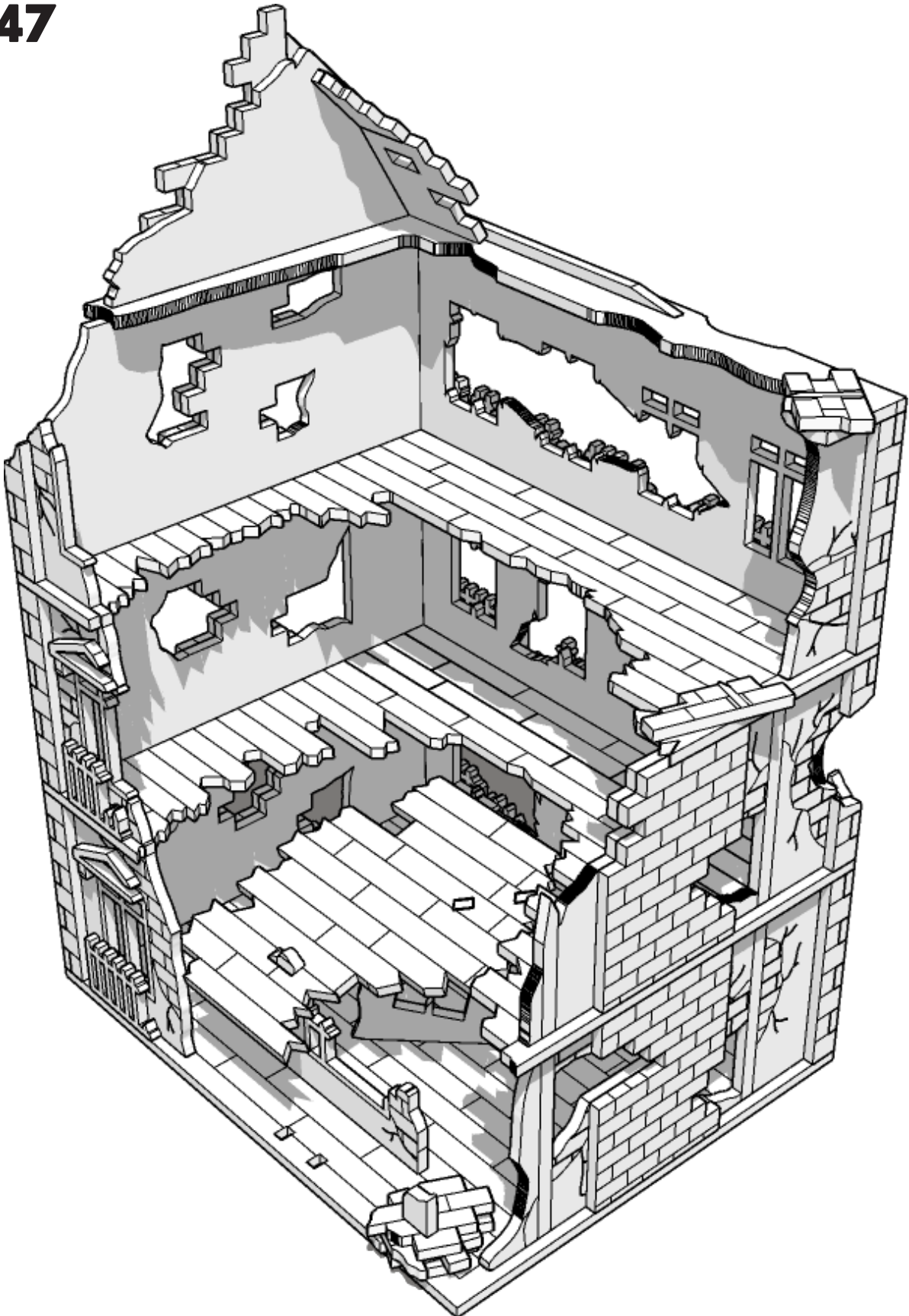



# TABLETOP SCENICS

**TTSC-WAR-083**  
**City, Corner & Delapidated**  
**Rowhouse Destroyed**

**148**

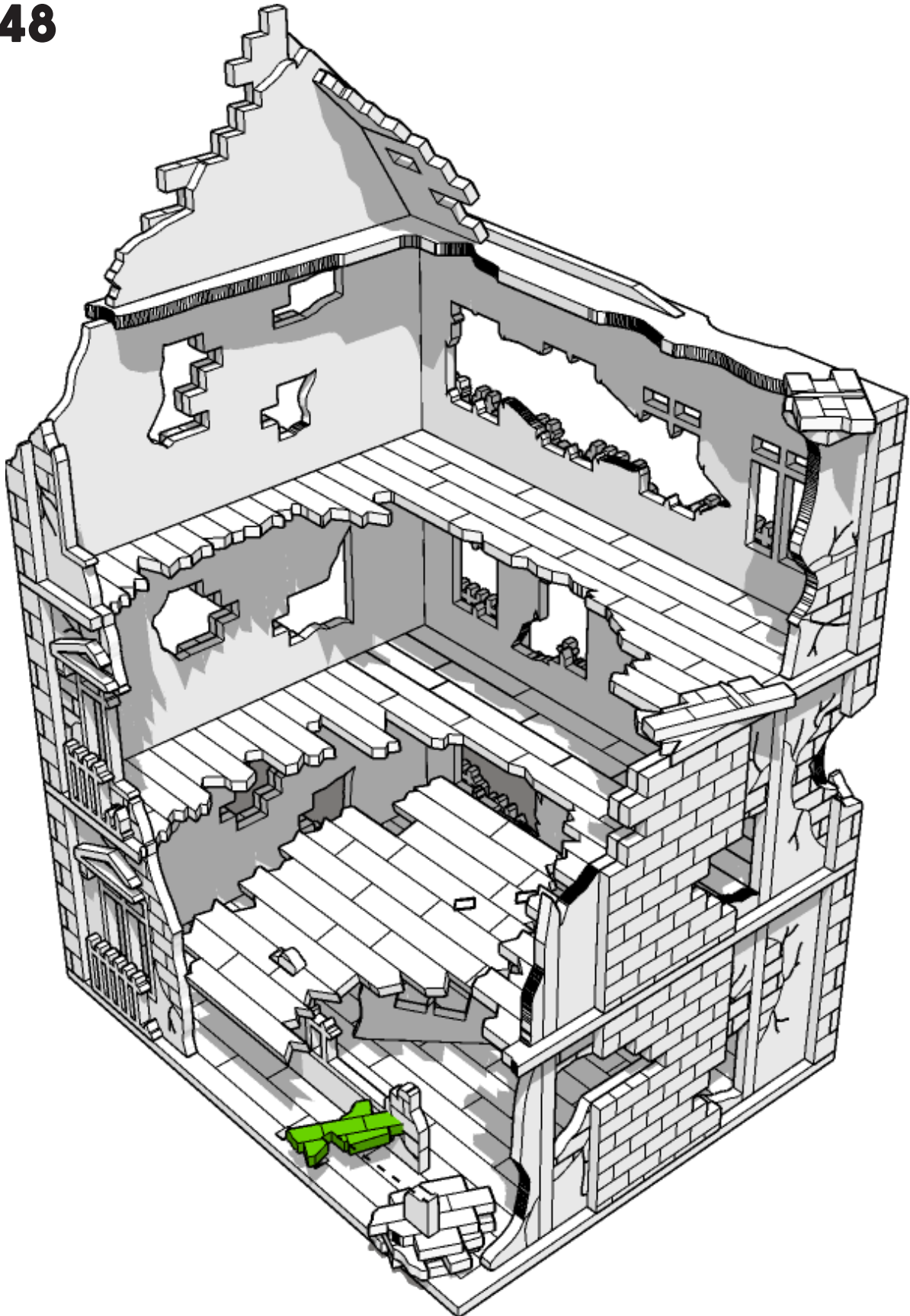



# TABLETOP SCENICS

TTSC-WAR-083  
City, Corner & Delapidated  
Rowhouse Destroyed

149

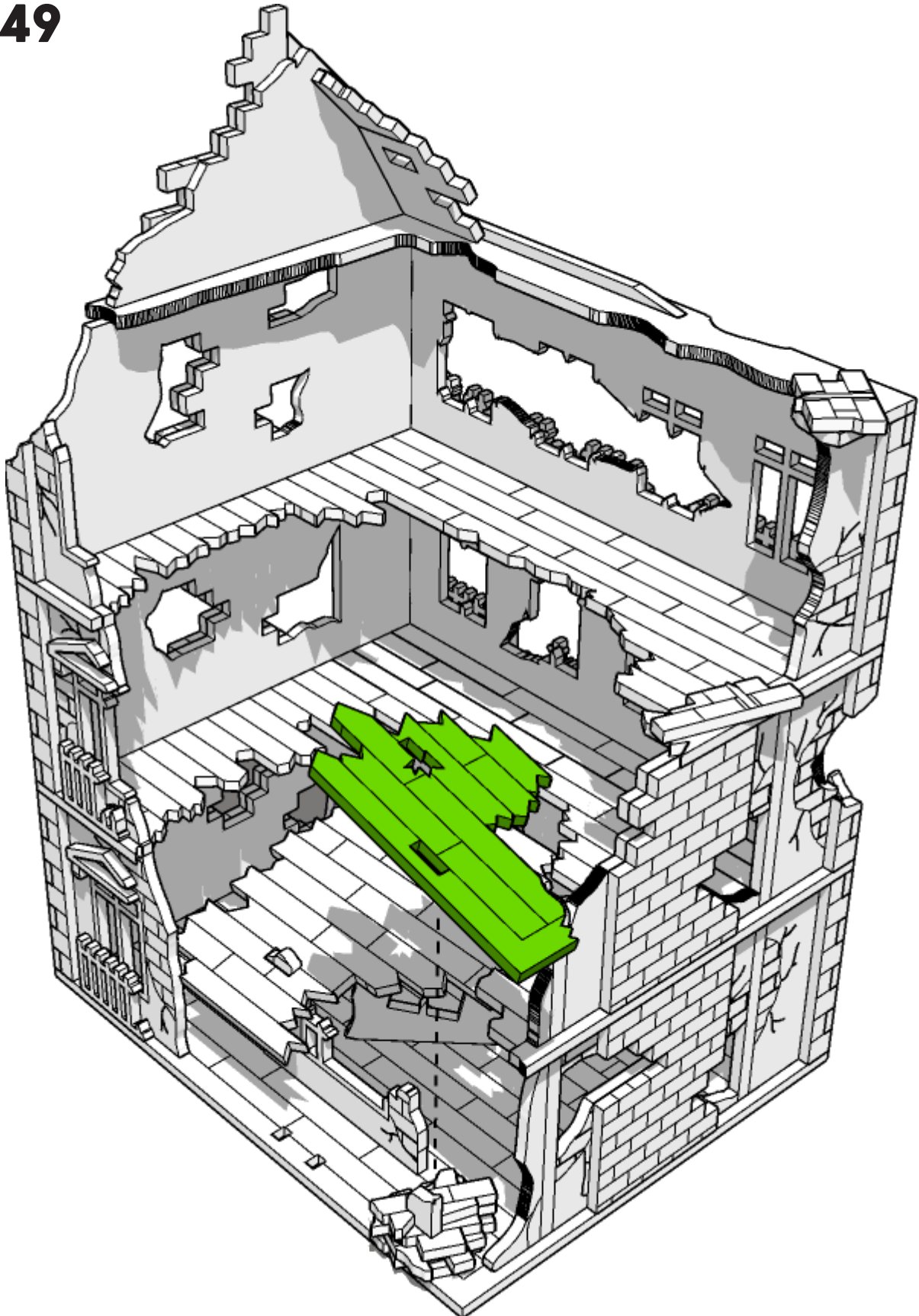



# TABLETOP SCENICS

150

TTSC-WAR-083  
City, Corner & Delapidated  
Rowhouse Destroyed

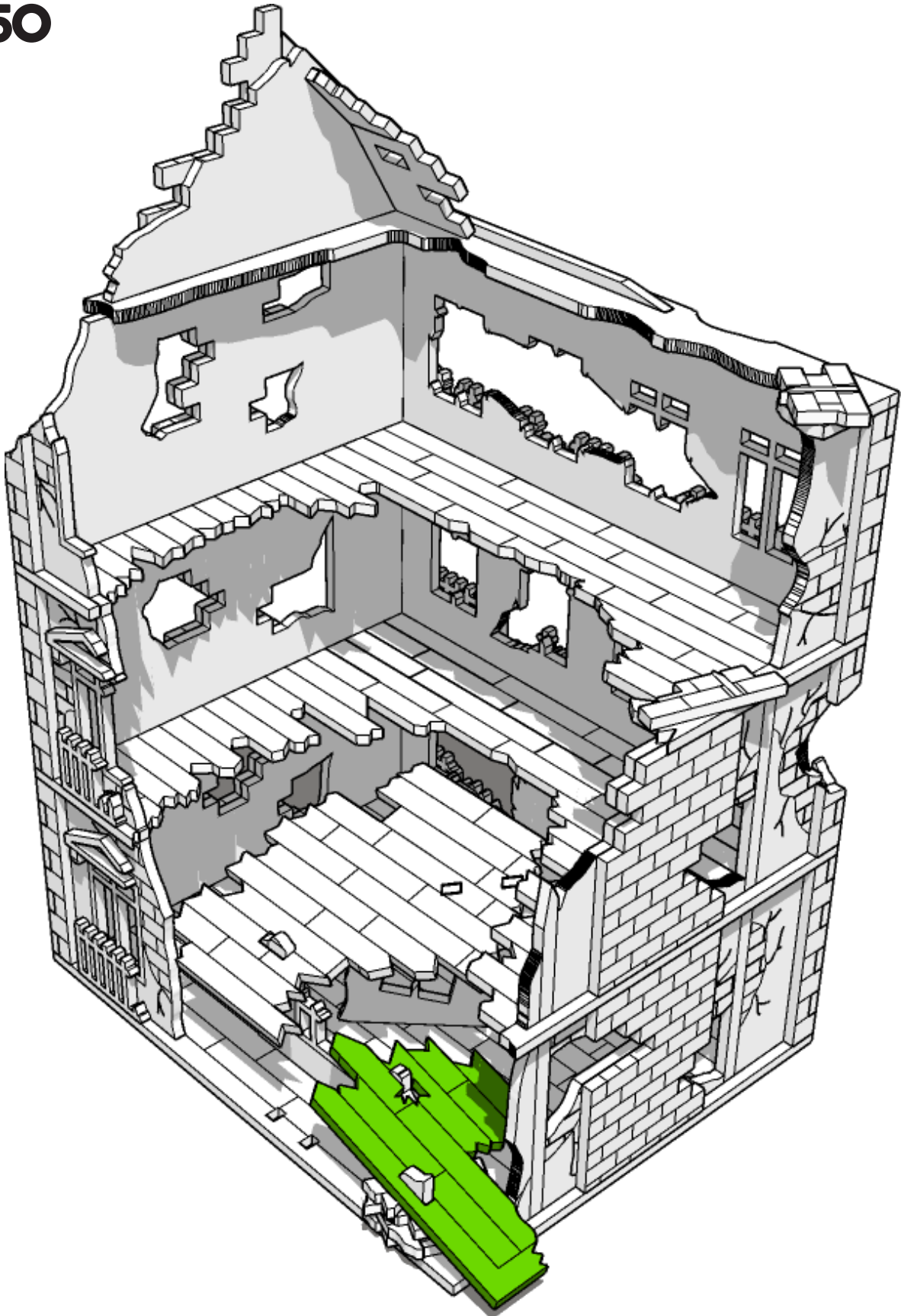



# TABLETOP SCENICS

**TTSC-WAR-083**  
**City, Corner & Delapidated**  
**Rowhouse Destroyed**

**151**

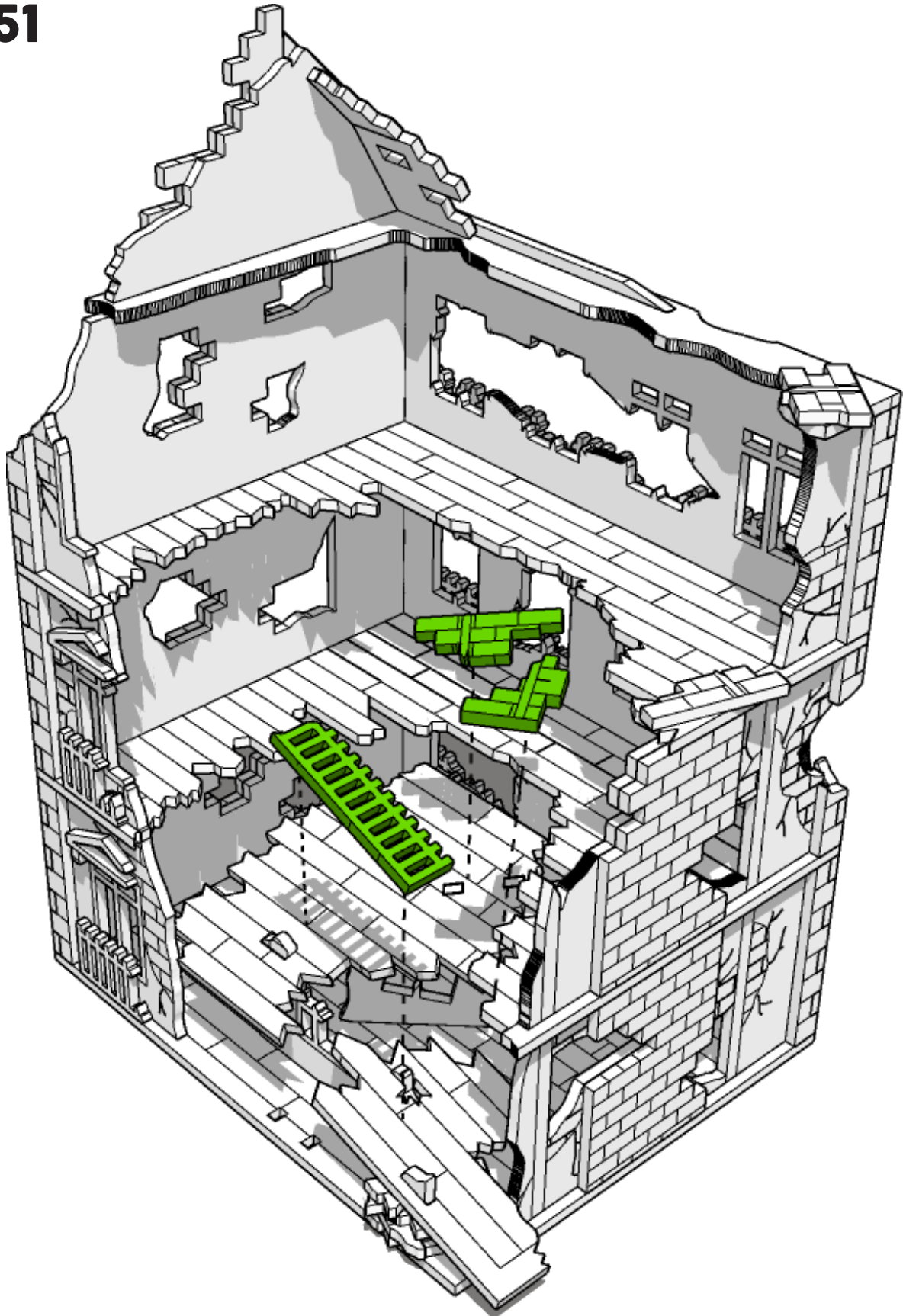





# TABLETOP SCENICS

**TTSC-WAR-083**  
**City, Corner & Delapidated**  
**Rowhouse Destroyed**

**152**

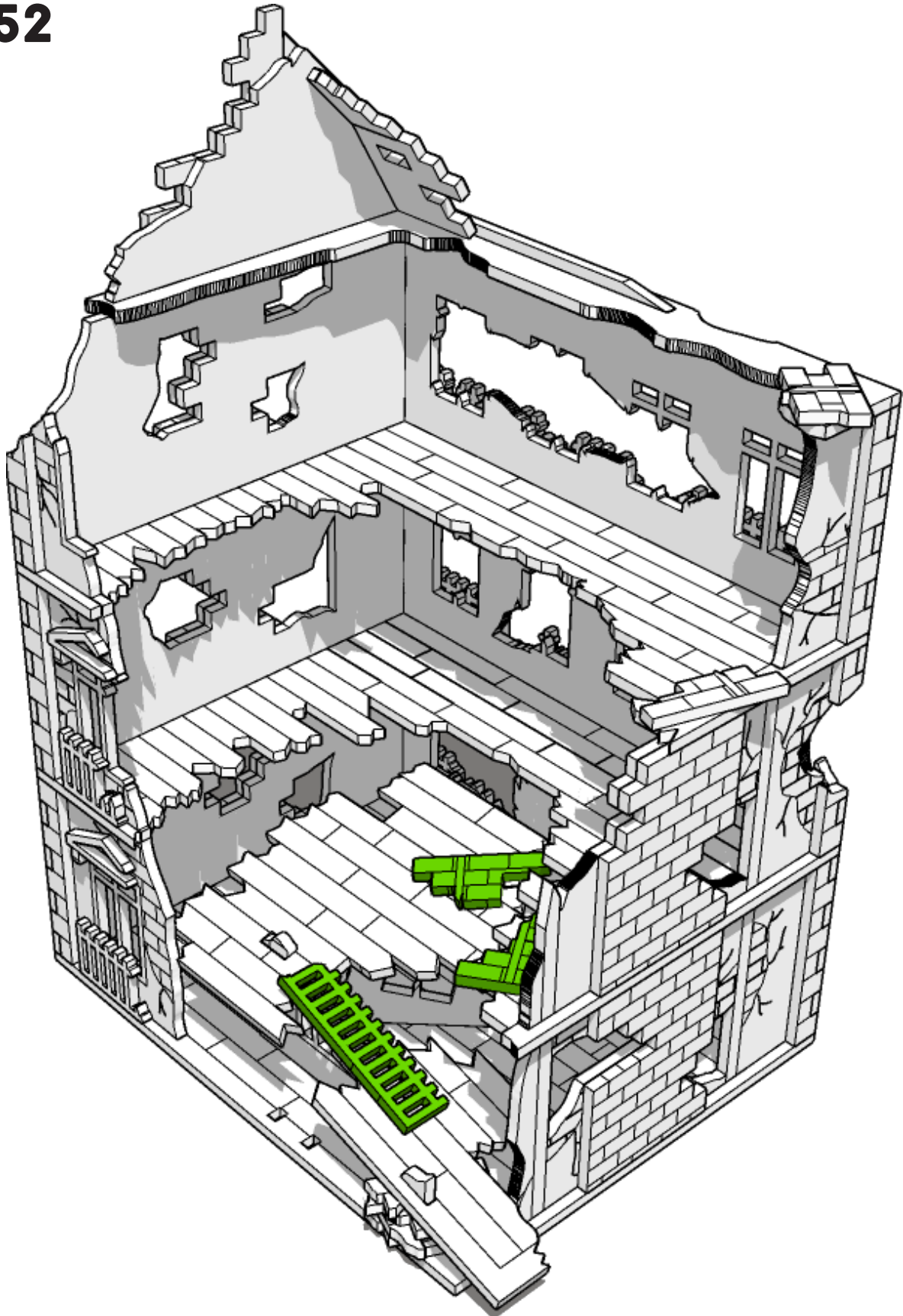



# TABLETOP SCENICS

**TTSC-WAR-O83**  
**City, Corner & Delapidated**  
**Rowhouse Destroyed**

**153**

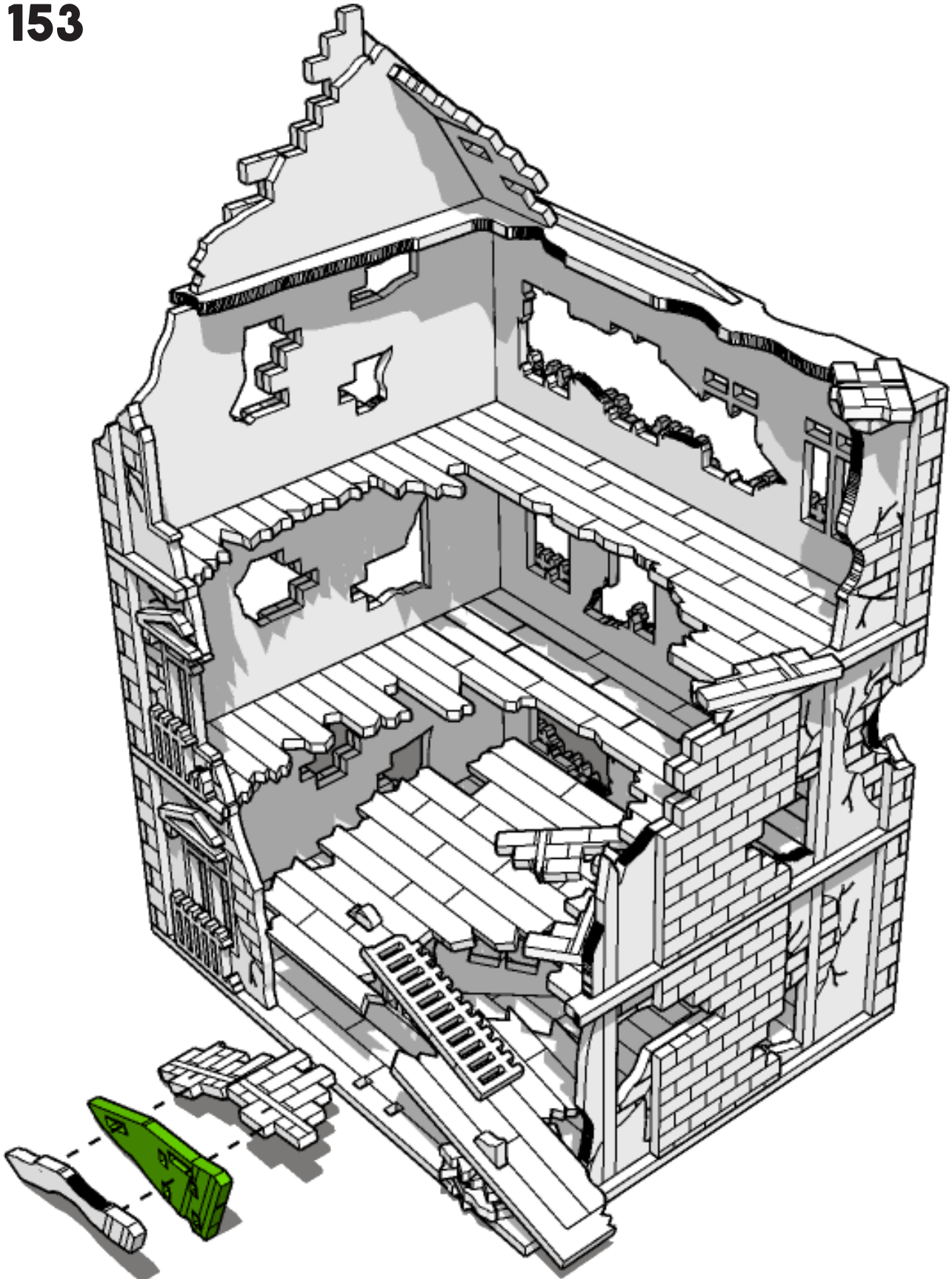



# TABLETOP SCENICS

TTSC-WAR-083  
City, Corner & Delapidated  
Rowhouse Destroyed

154

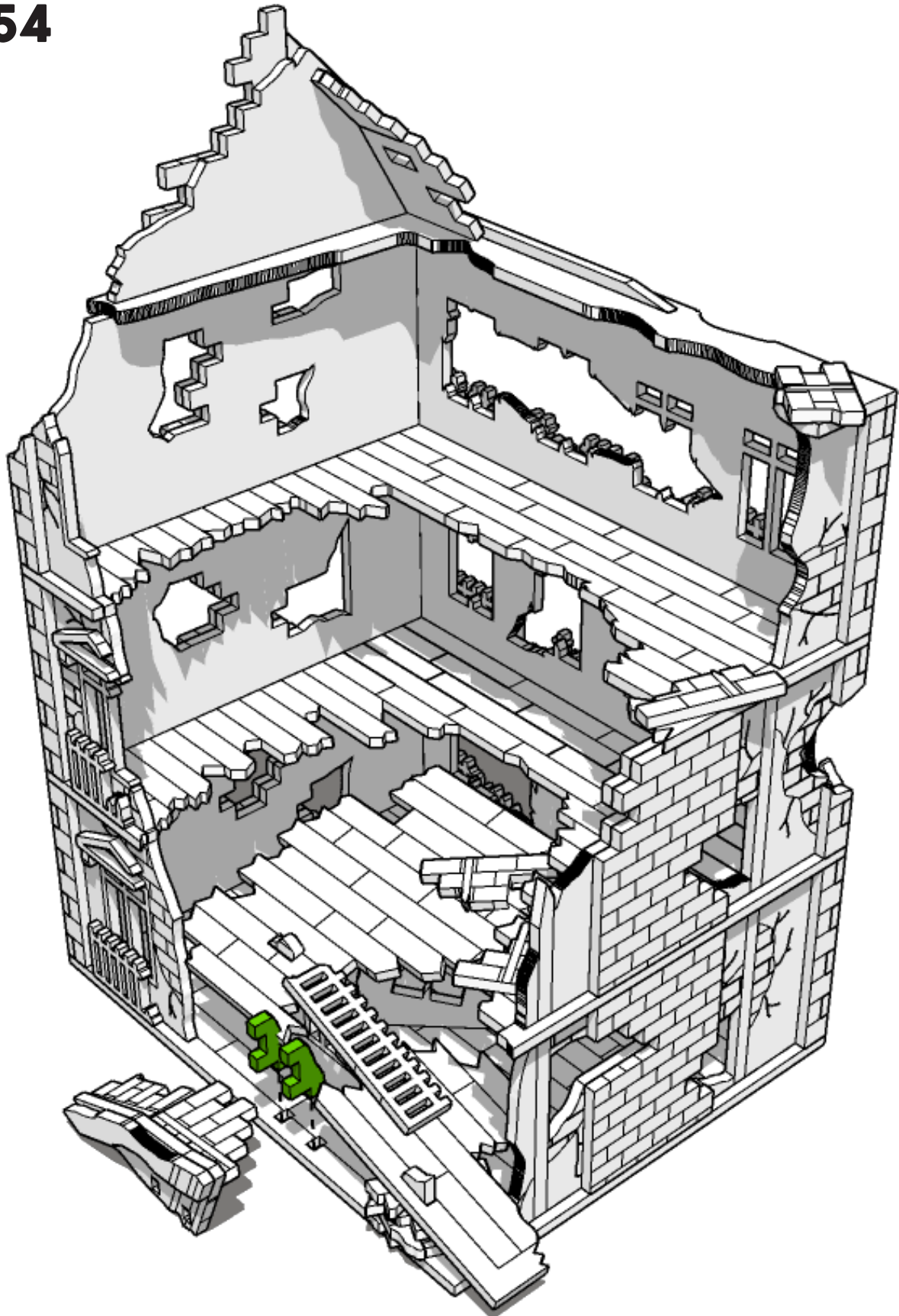



# TABLETOP SCENICS

**TTSC-WAR-O83**  
**City, Corner & Delapidated**  
**Rowhouse Destroyed**

**155**

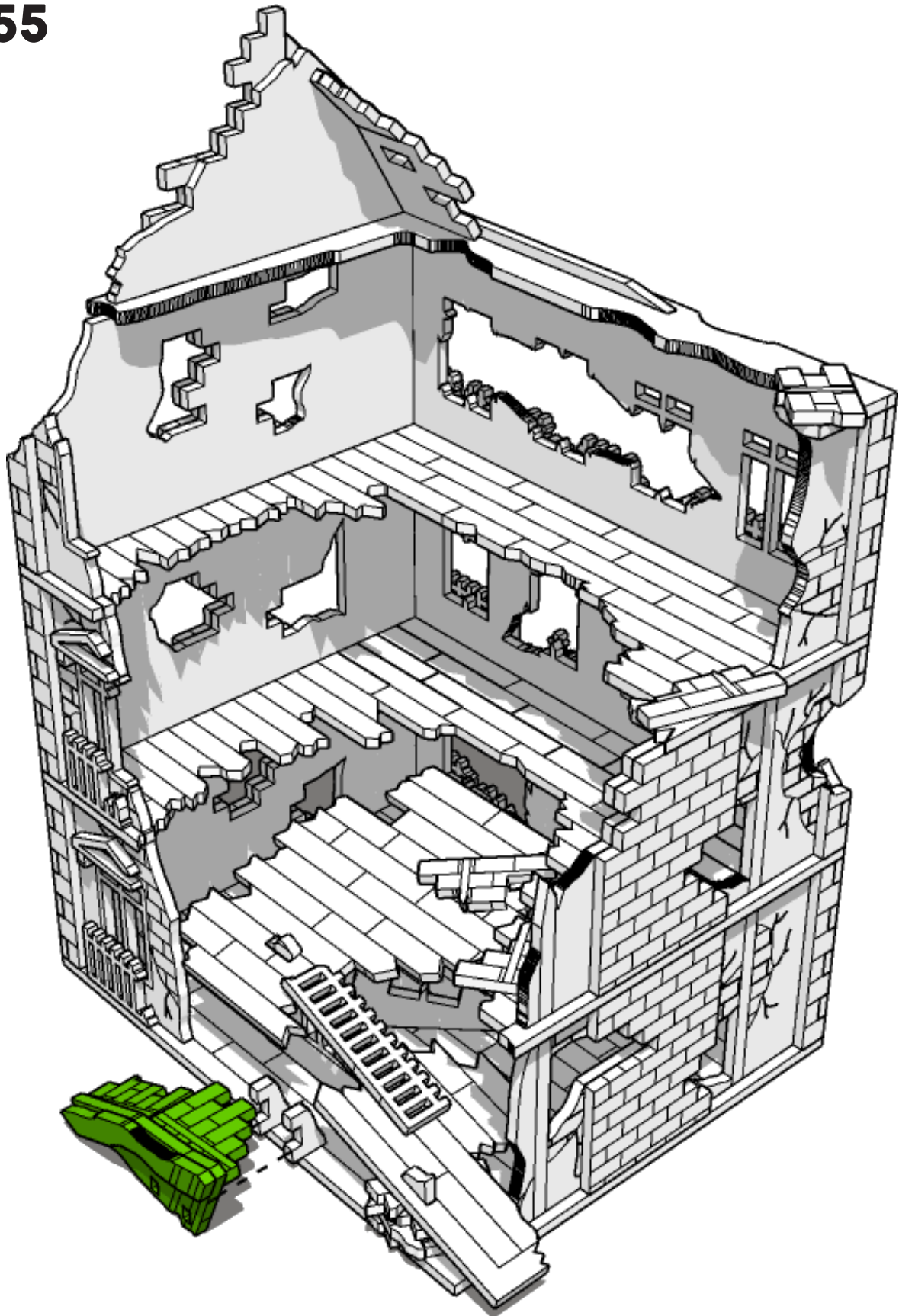



**TABLETOP  
SCENICS**

**TTSC-WAR-083  
City, Corner & Delapidated  
Rowhouse Destroyed**

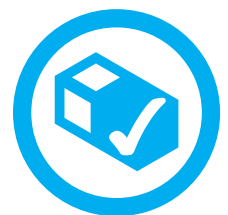
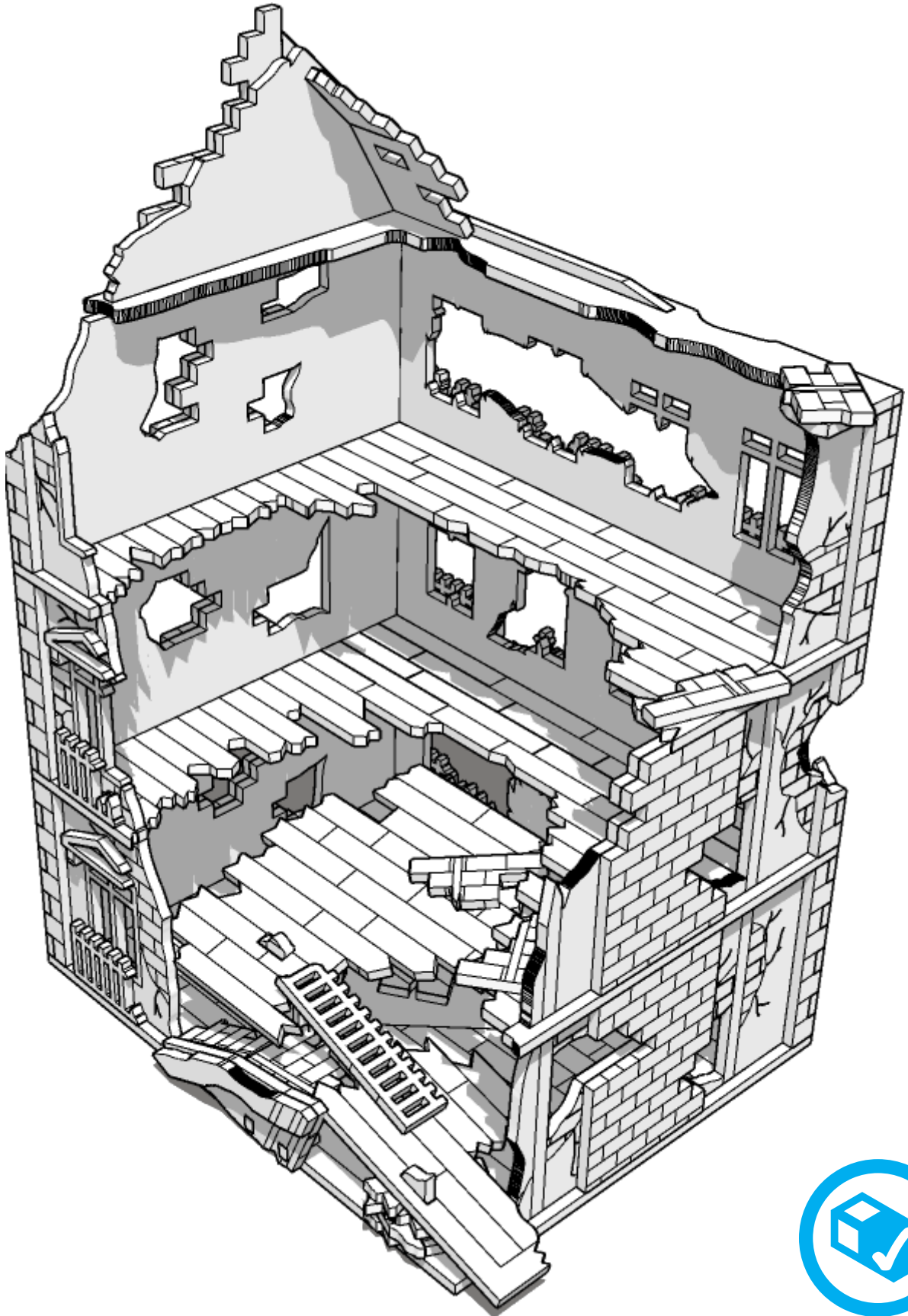

 **TTCOMBAT**



# TABLETOP SCENICS

157

TTSC-WAR-O83  
City, Corner & Delapidated  
Rowhouse Destroyed

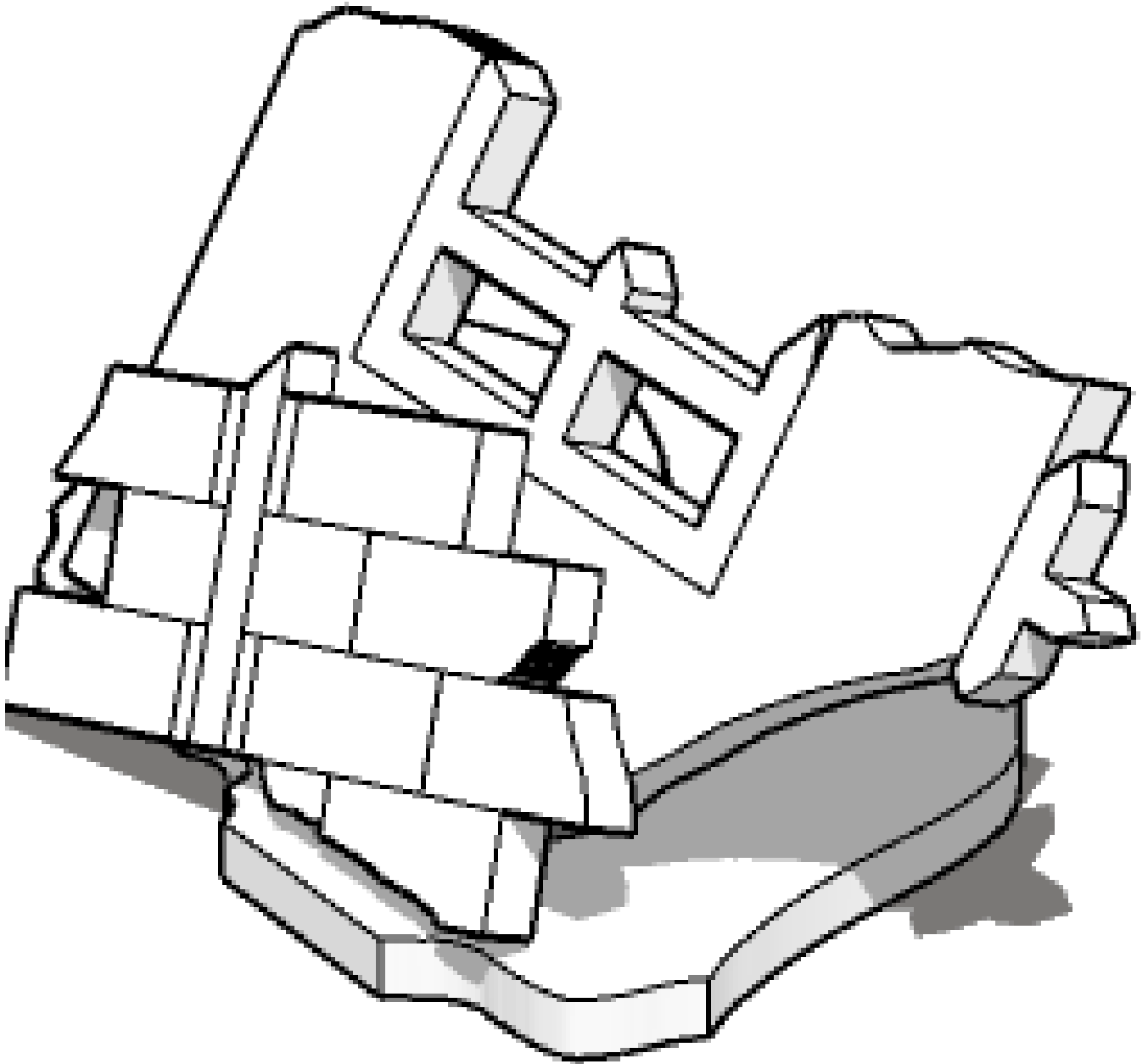



# TABLETOP SCENICS

158

TTSC-WAR-O83  
City, Corner & Delapated  
Rowhouse Destroyed

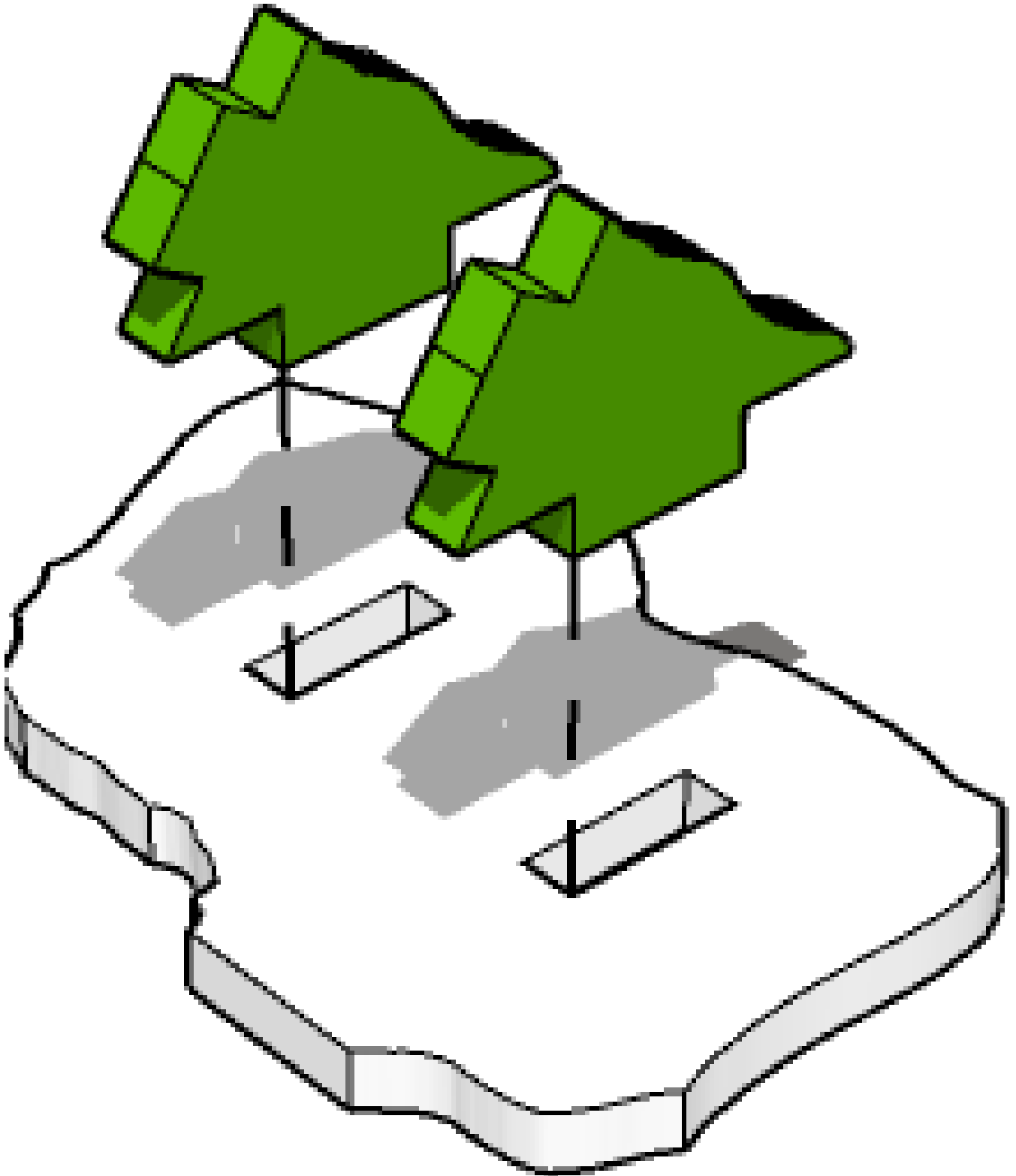



# TABLETOP SCENICS

159

TTSC-WAR-O83  
City, Corner & Delapidated  
Rowhouse Destroyed

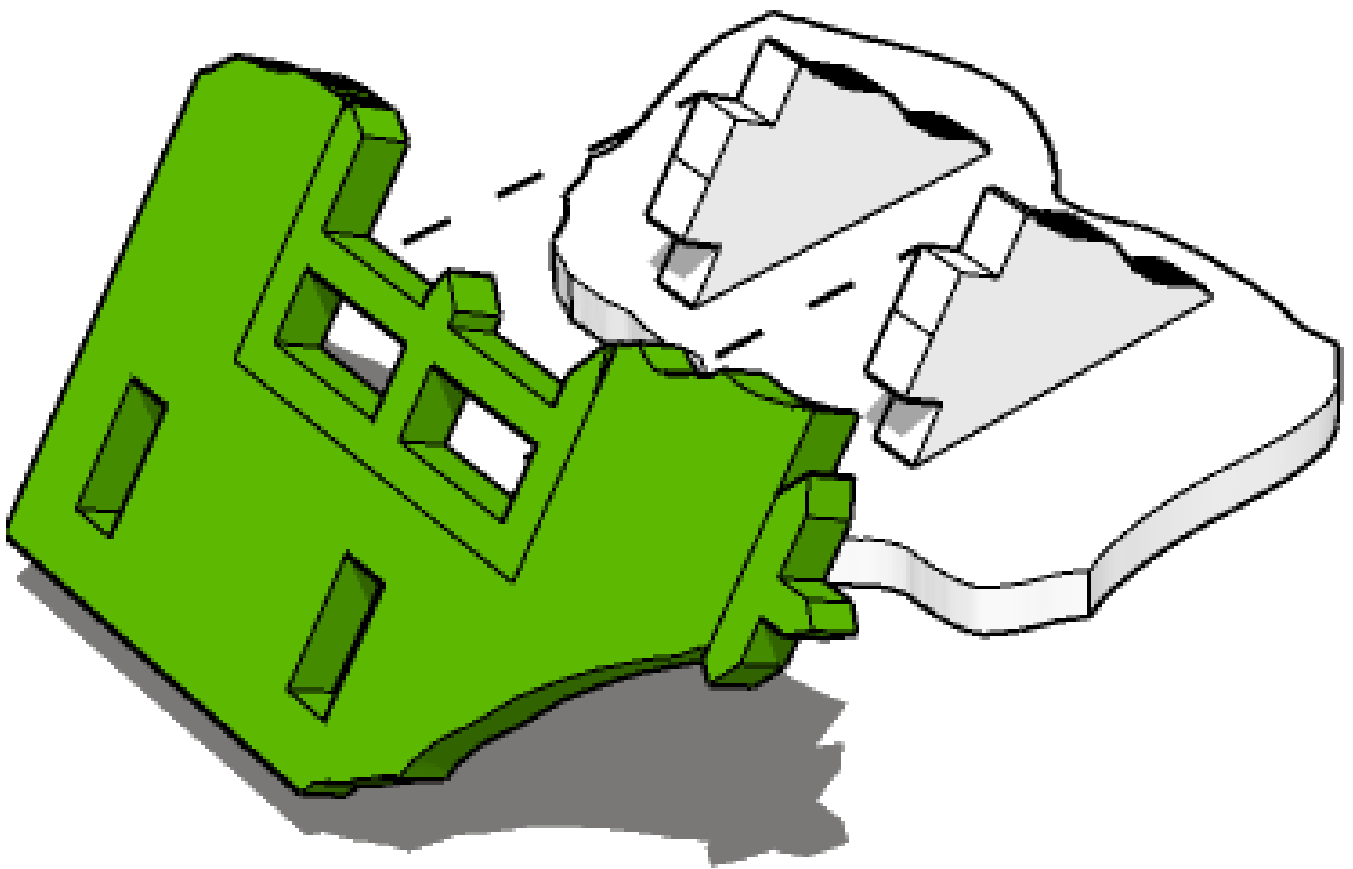





# TABLETOP SCENICS

160

TTSC-WAR-O83  
City, Corner & Delapidated  
Rowhouse Destroyed

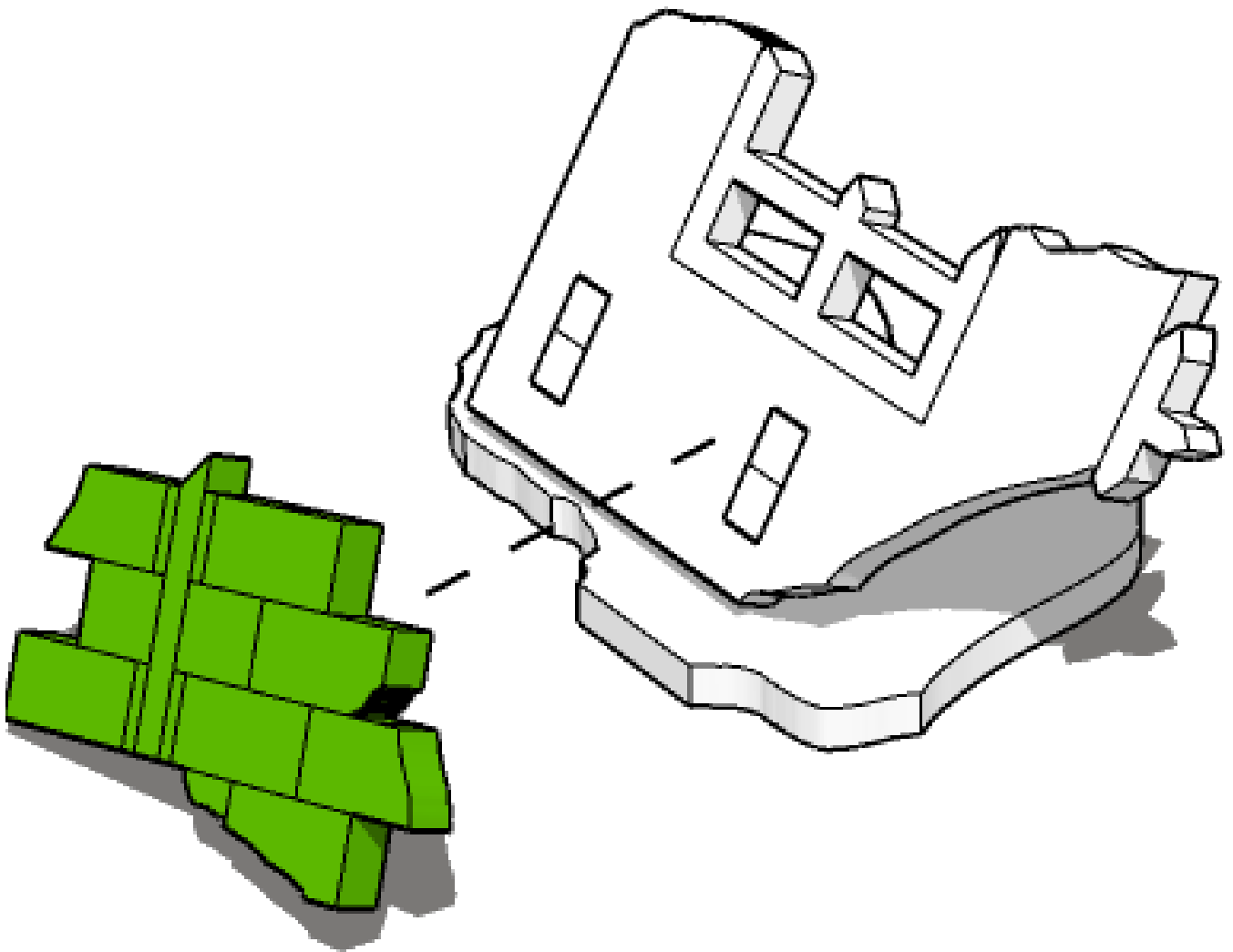



**TABLETOP  
SCENICS**

**TTSC-WAR-O83  
City, Corner & Delapidated  
Rowhouse Destroyed**

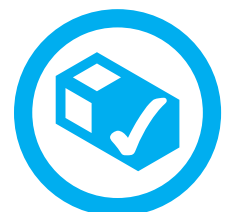
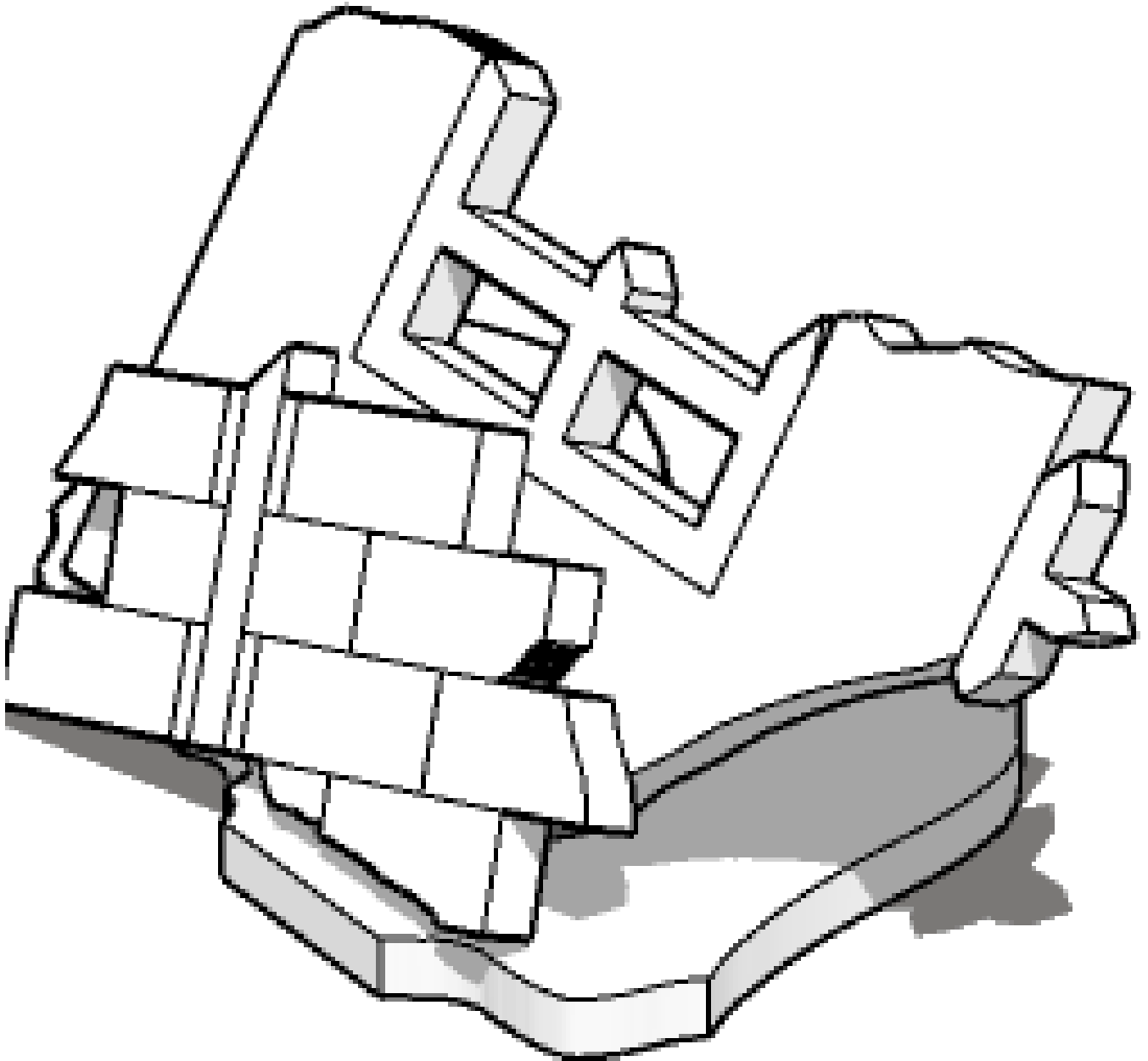

 **TTCOMBAT**



# TABLETOP SCENICS

162

TTSC-WAR-O83  
City, Corner & Delapidated  
Rowhouse Destroyed

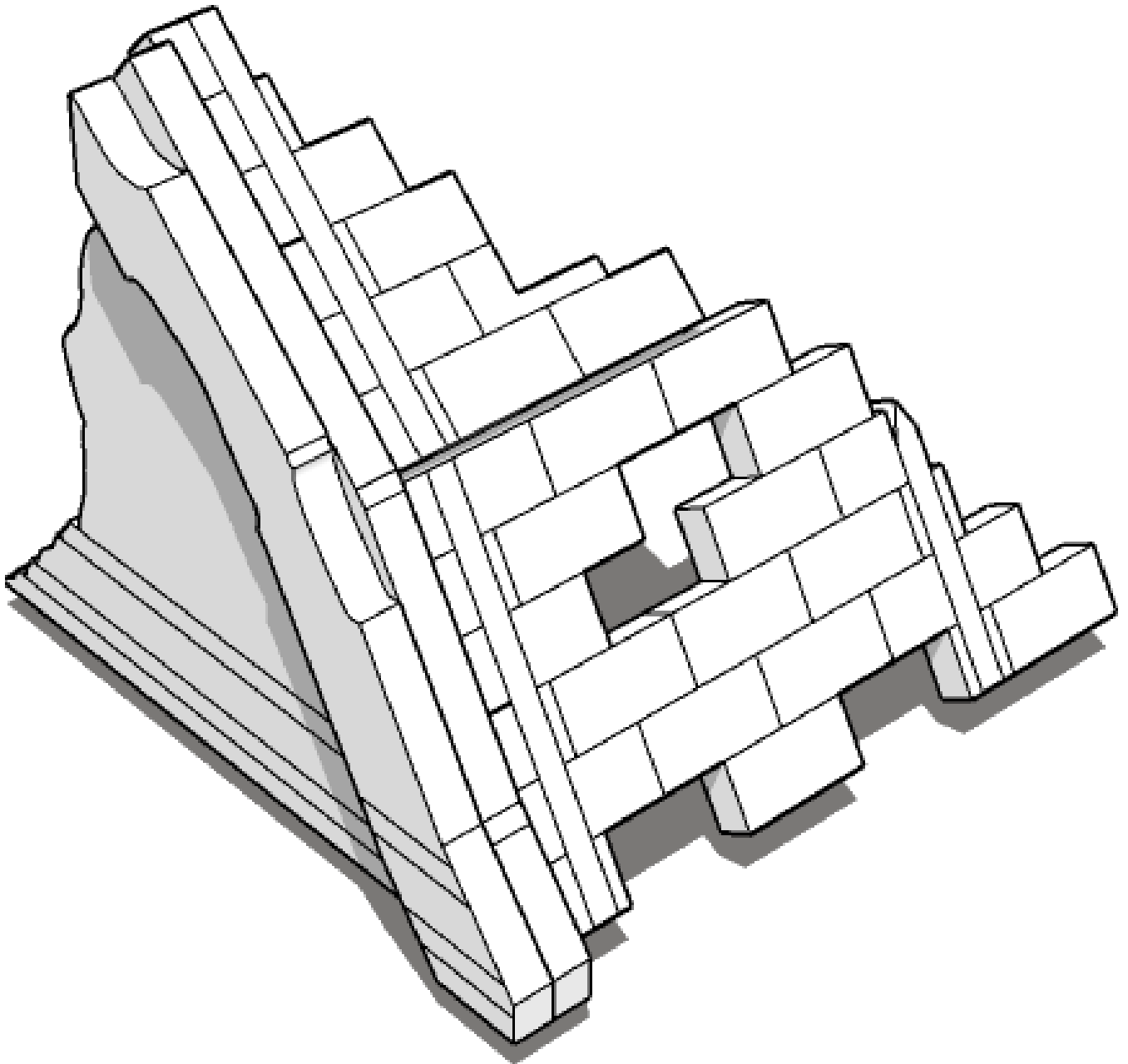



# TABLETOP SCENICS

163

**TTSC-WAR-O83**  
**City, Corner & Delapidated**  
**Rowhouse Destroyed**

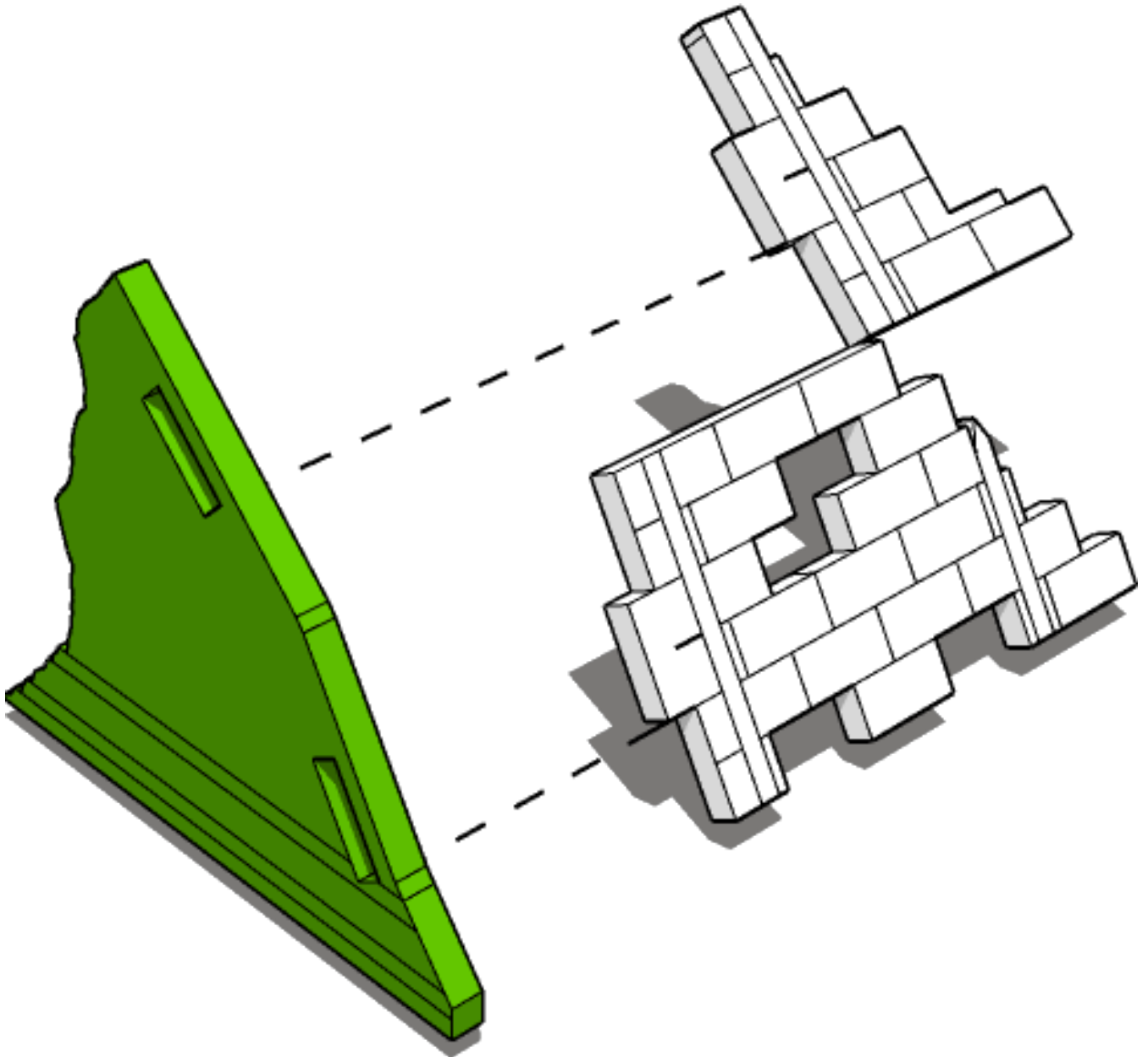



# TABLETOP SCENICS

**TTSC-WAR-O83**  
**City, Corner & Delapidated**  
**Rowhouse Destroyed**

**164**

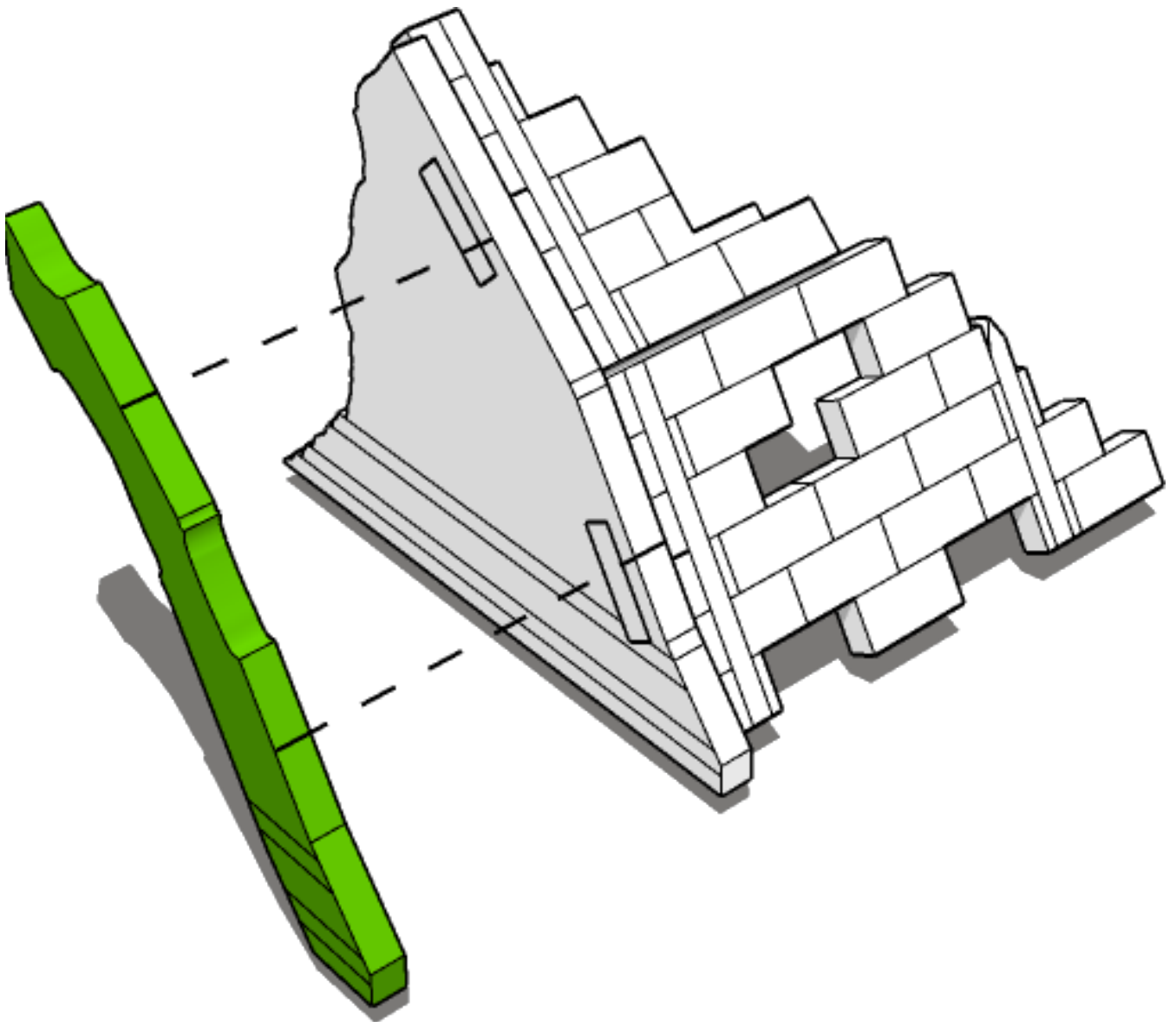



**TABLETOP  
SCENICS**

**TTSC-WAR-O83  
City, Corner & Delapidated  
Rowhouse Destroyed**

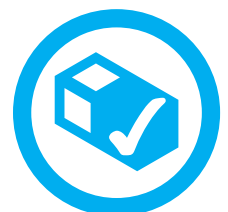
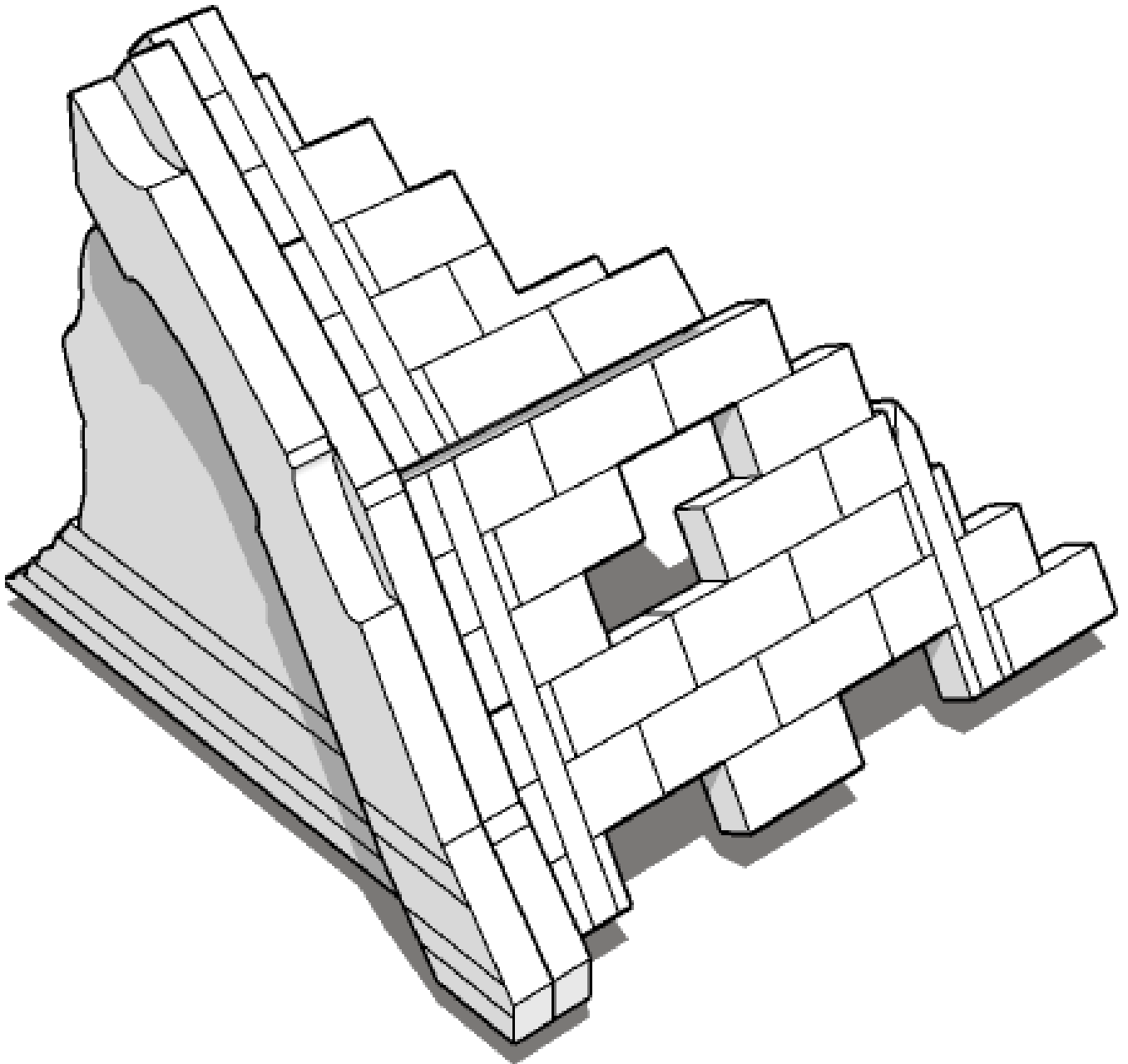

 **TTCOMBAT**



# TABLETOP SCENICS

166

TTSC-WAR-O83  
City, Corner & Delapidated  
Rowhouse Destroyed

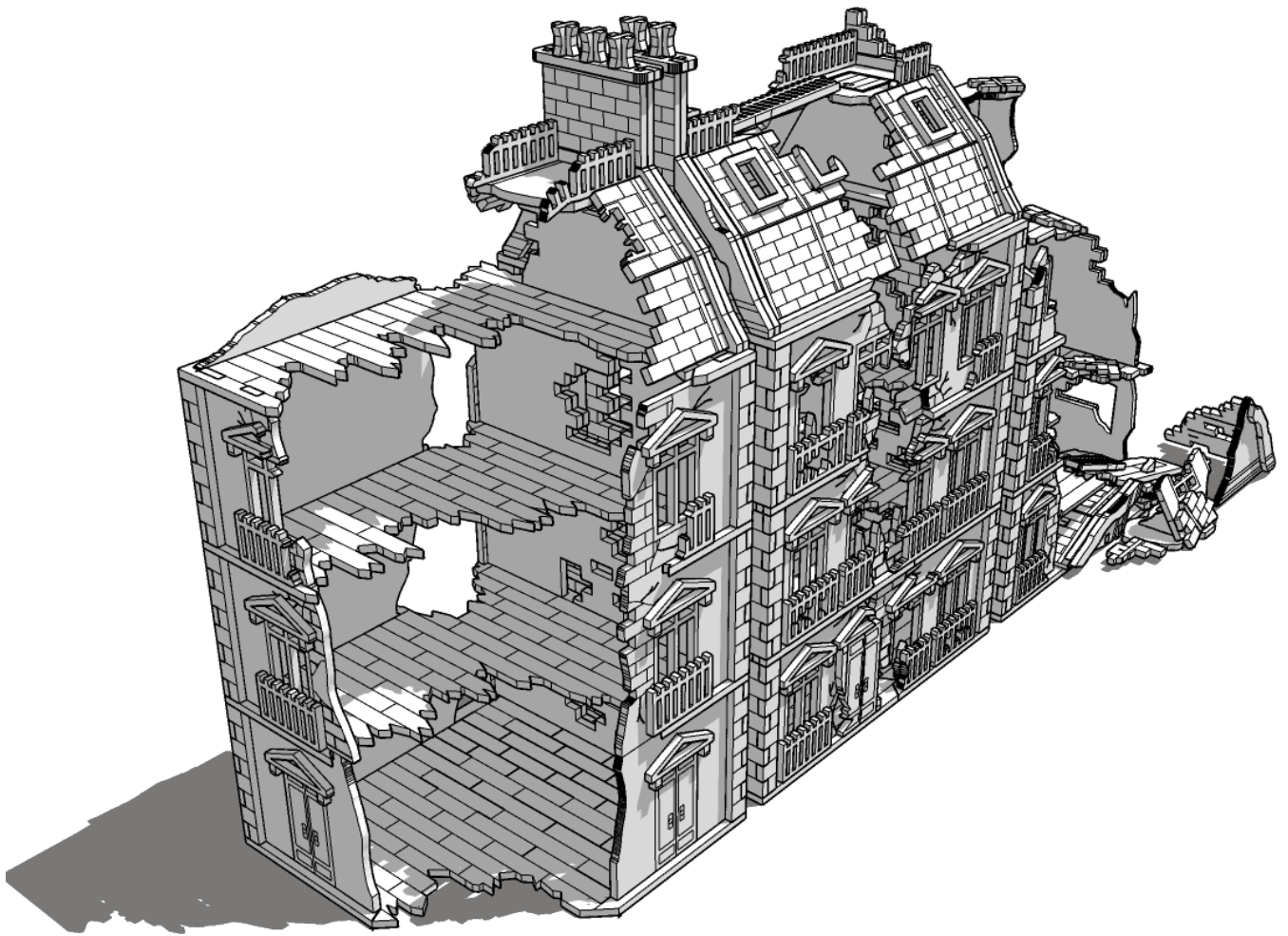

 TTCOMBAT