

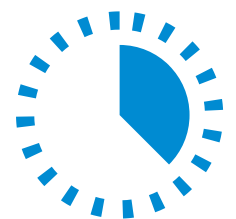

# TABLETOP SCENICS

**TTSCW-SFU-112**  
**Mod.Co.N**  
**3x2 Straights**

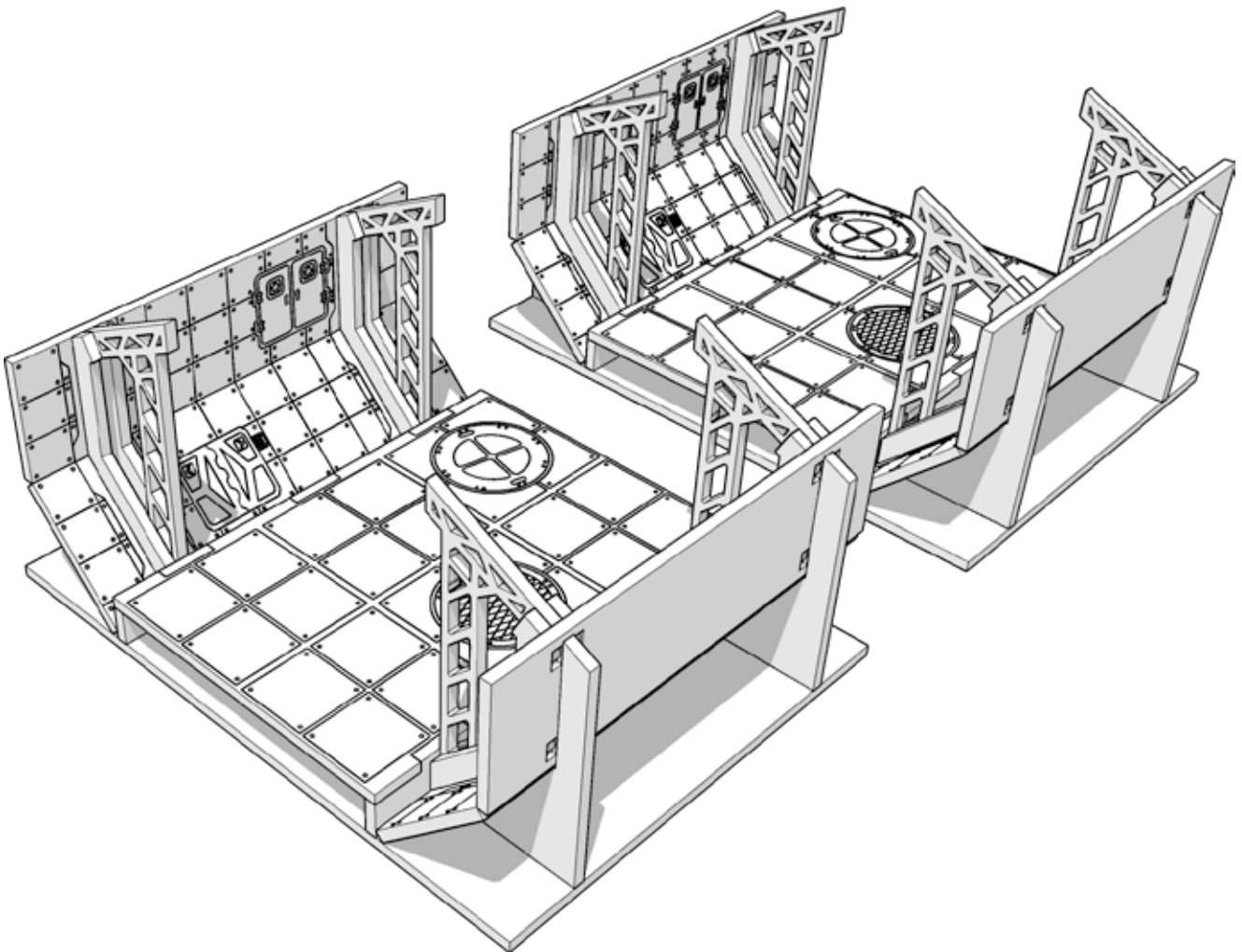

 **TTCOMBAT**



# TABLETOP SCENICS

**TTSCW-SFU-112**  
**Mod.Co.N**  
**3x2 Straights**

## 2

These are a series of icons that may be used throughout the instructions to help your assembly.  
If in doubt, scroll ahead to confirm.



Do not glue this part



Carefully score and  
fold this part

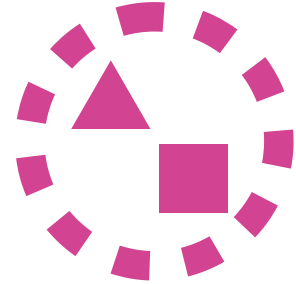

This part - or its placement is  
completely optional

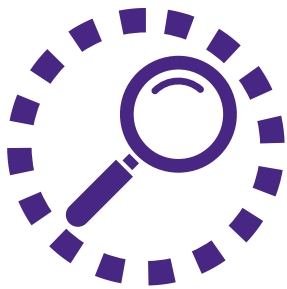

Look closely at this step -  
The process order or part  
used, may be specific



Repeat making this part  
the specified number  
of times

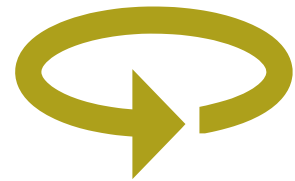

The next instruction step  
will be the same assembly  
so far, but from a different  
angle

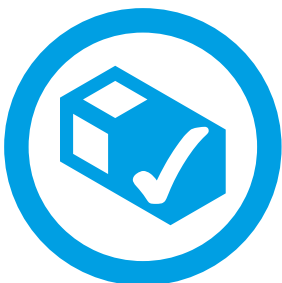

Sub-assembly complete.  
This smaller construction  
is ready to add to the  
main kit



Assembly Complete! There  
could be more optional  
parts - check to the very end  
of instructions



FRAGILE: DO NOT BEND.  
“Bendy wood” is designed to  
curve around a designed  
frame only.



# TABLETOP SCENICS

TTSCW-SFU-112  
Mod.Co.N  
3x2 Straights

3

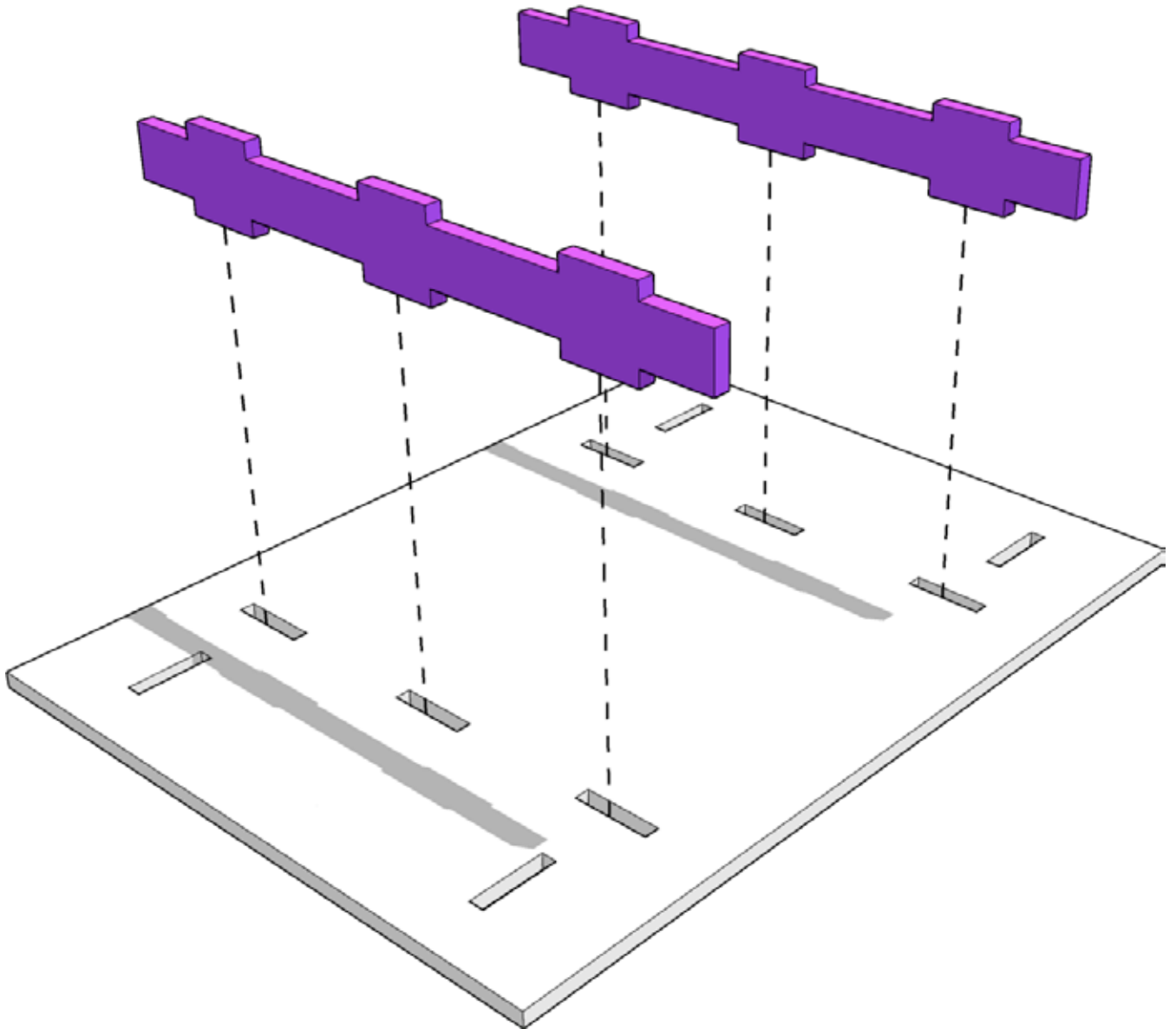



# TABLETOP SCENICS

**TTSCW-SFU-112**  
**Mod.Co.N**  
**3x2 Straights**

**4**

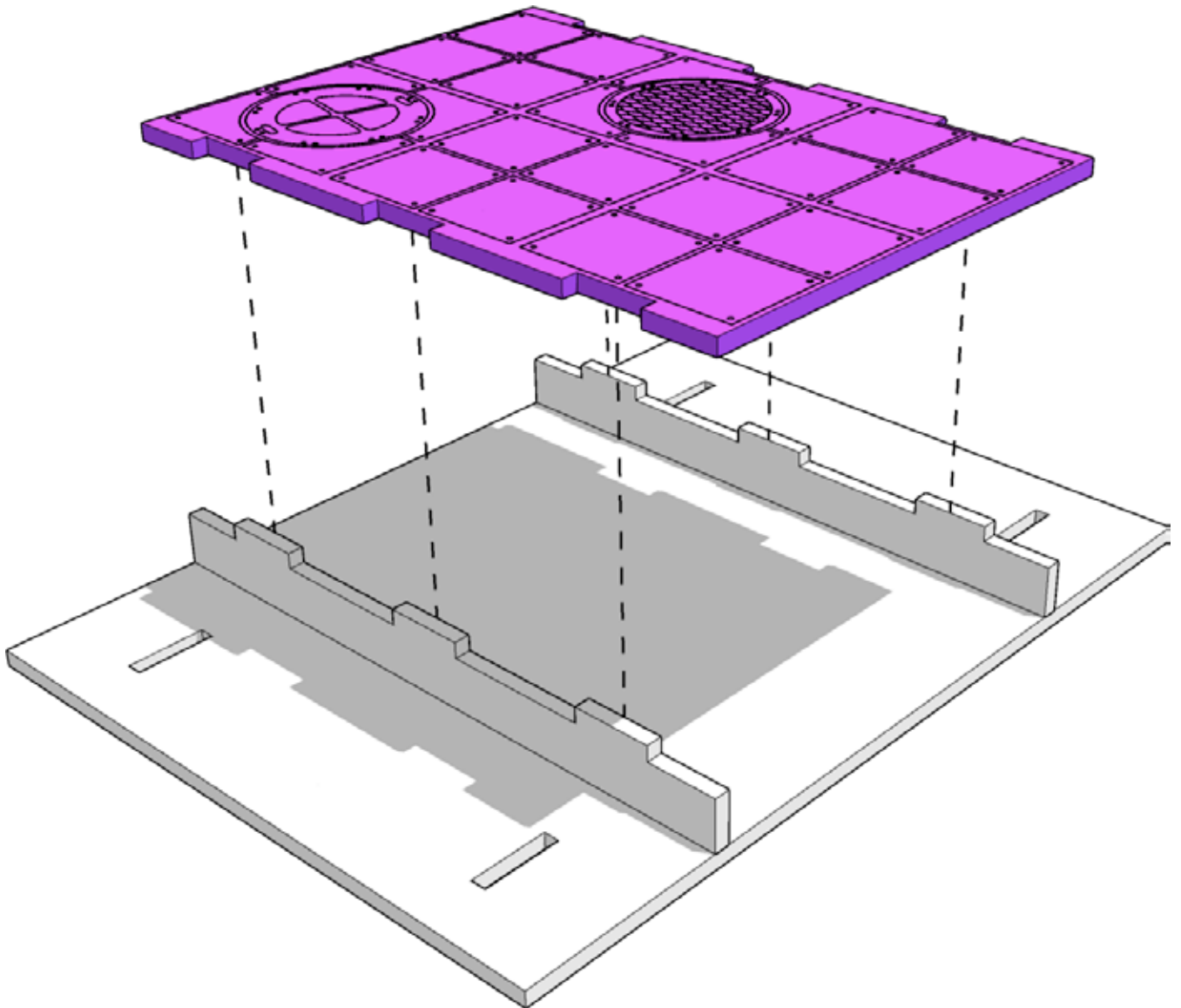



# TABLETOP SCENICS

**TTSCW-SFU-112**  
**Mod.Co.N**  
**3x2 Straights**

**5**

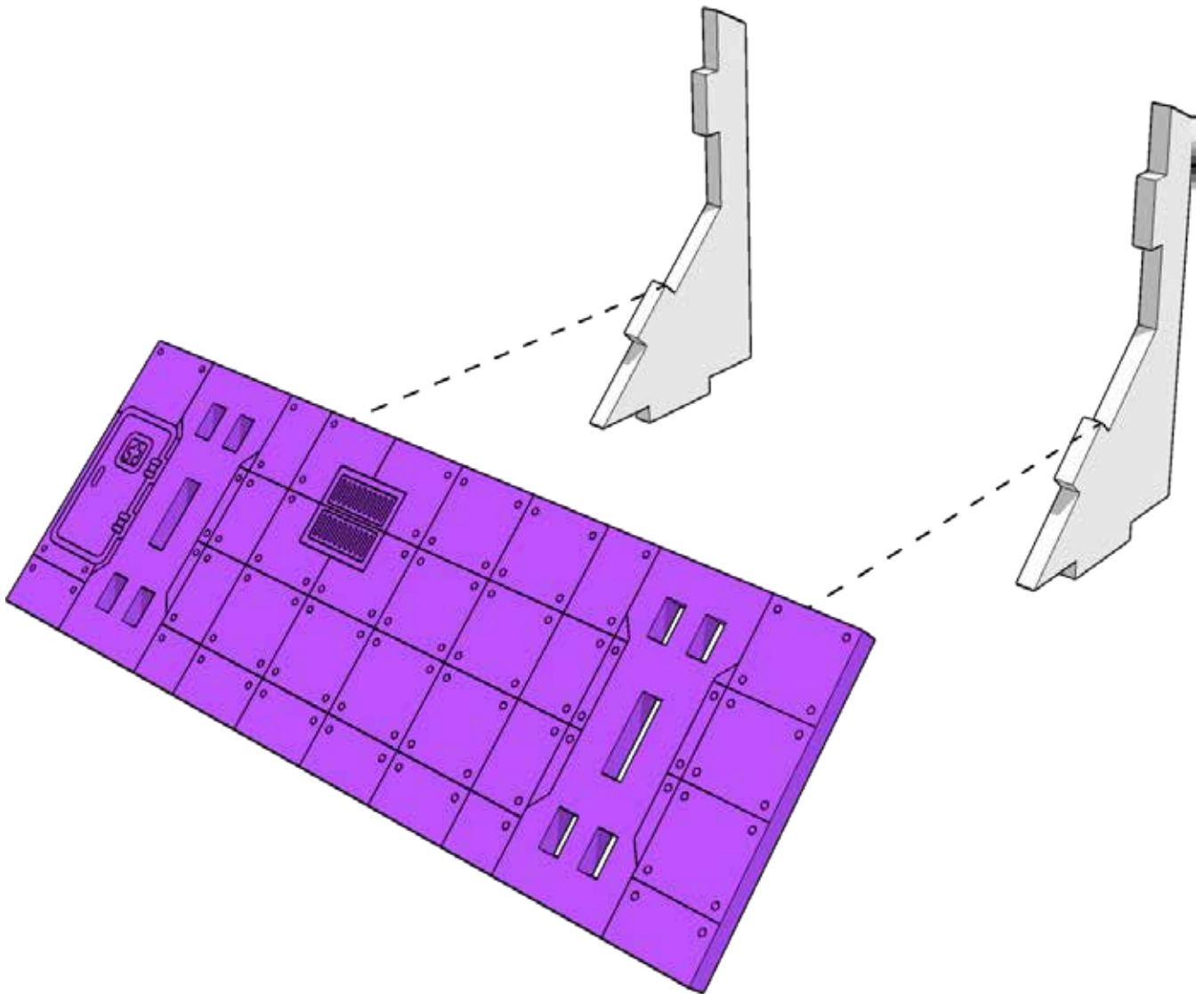



# TABLETOP SCENICS

**TTSCW-SFU-112**  
**Mod.Co.N**  
**3x2 Straights**

**6**

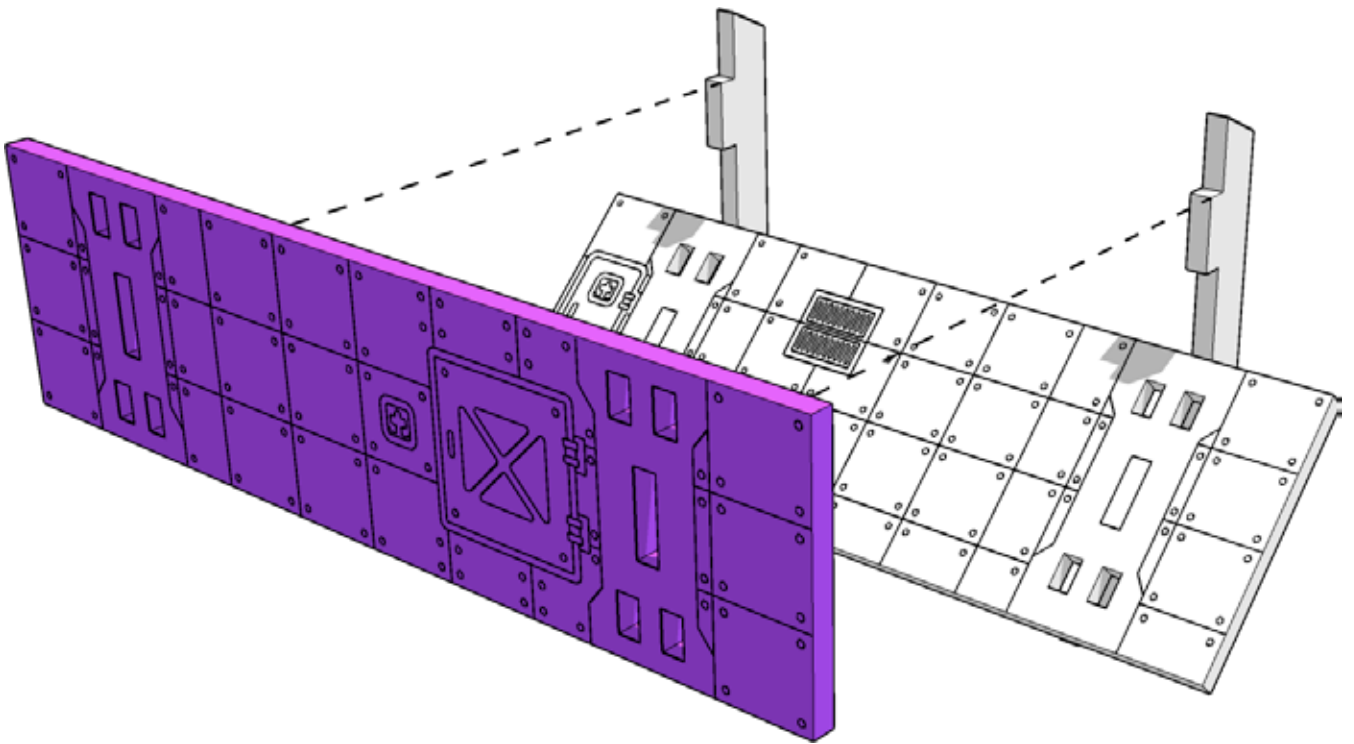



# TABLETOP SCENICS

**TTSCW-SFU-112**  
**Mod.Co.N**  
**3x2 Straights**

**7**

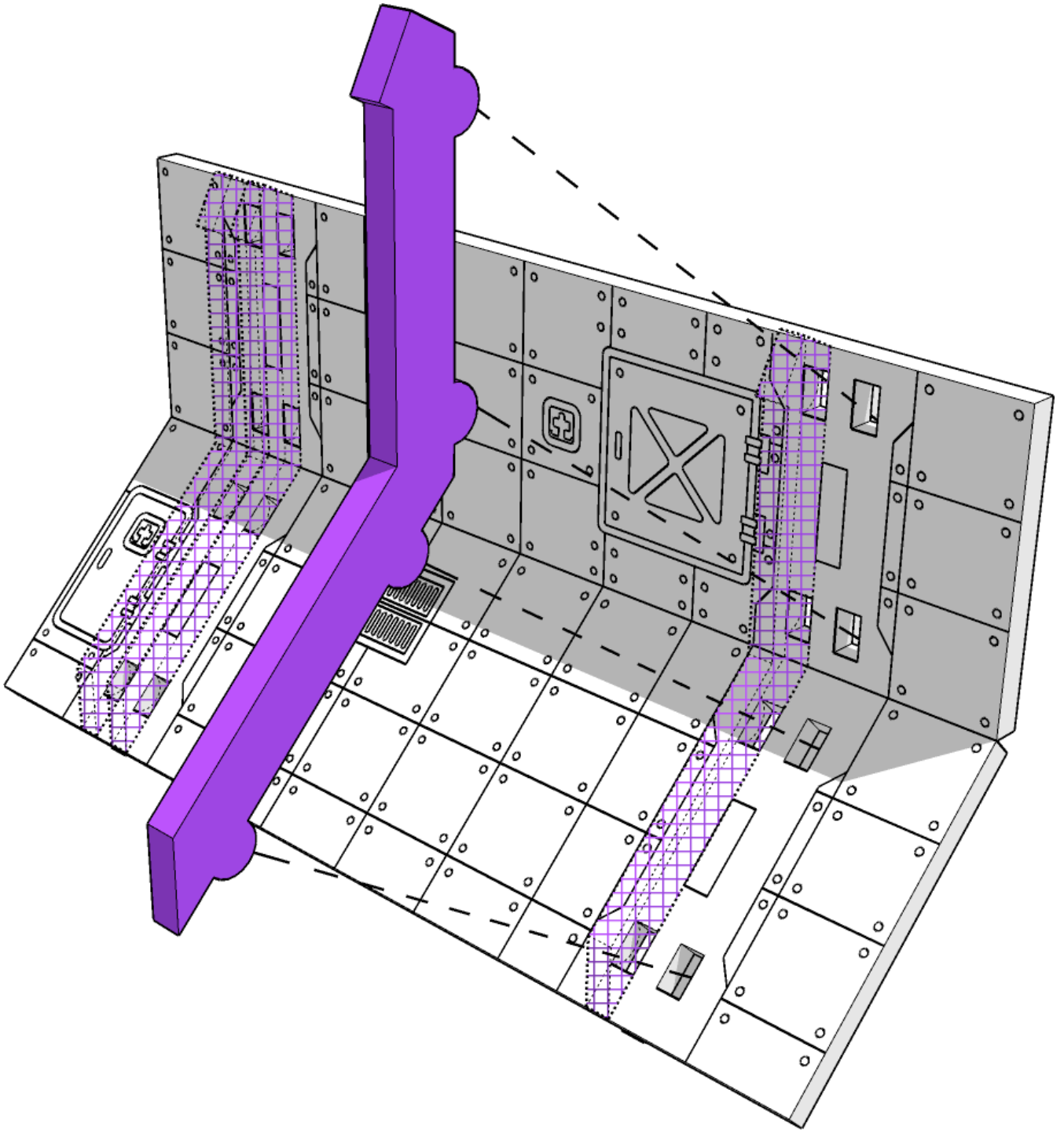



# TABLETOP SCENICS

**TTSCW-SFU-112**  
**Mod.Co.N**  
**3x2 Straights**

**8**

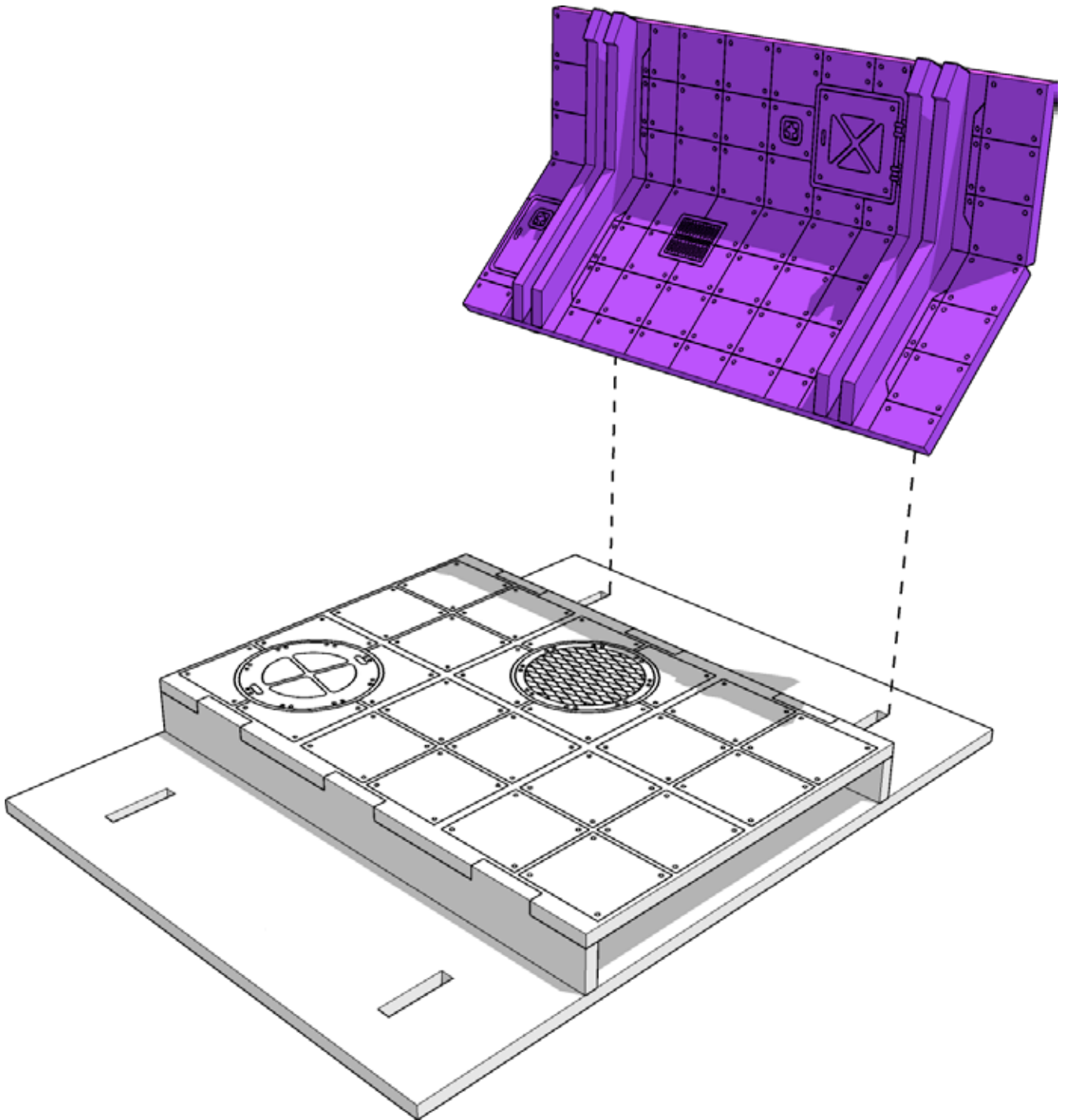





# TABLETOP SCENICS

**TTSCW-SFU-112**  
**Mod.Co.N**  
**3x2 Straights**

**9**

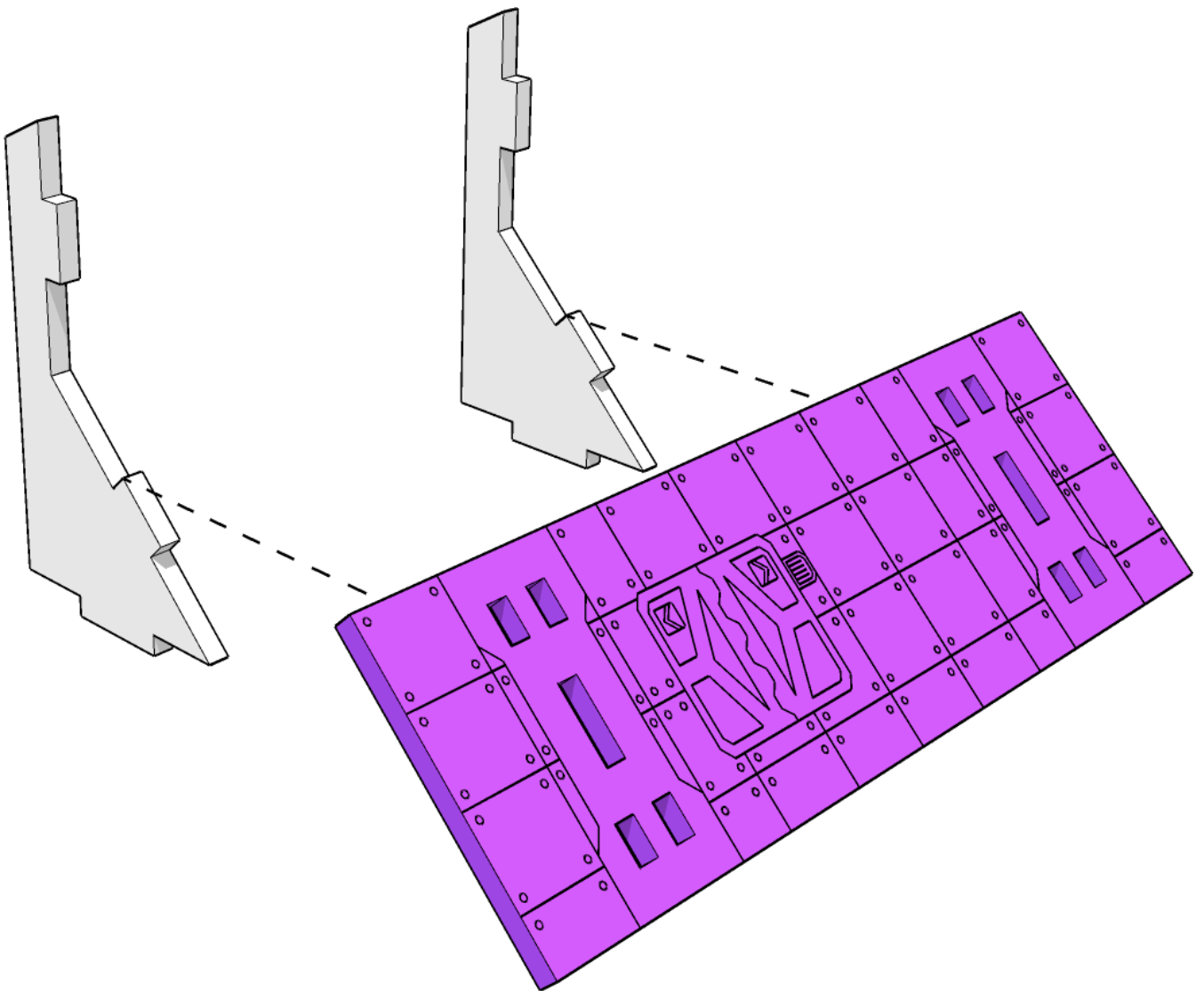



# TABLETOP SCENICS

**TTSCW-SFU-112**  
**Mod.Co.N**  
**3x2 Straights**

**10**

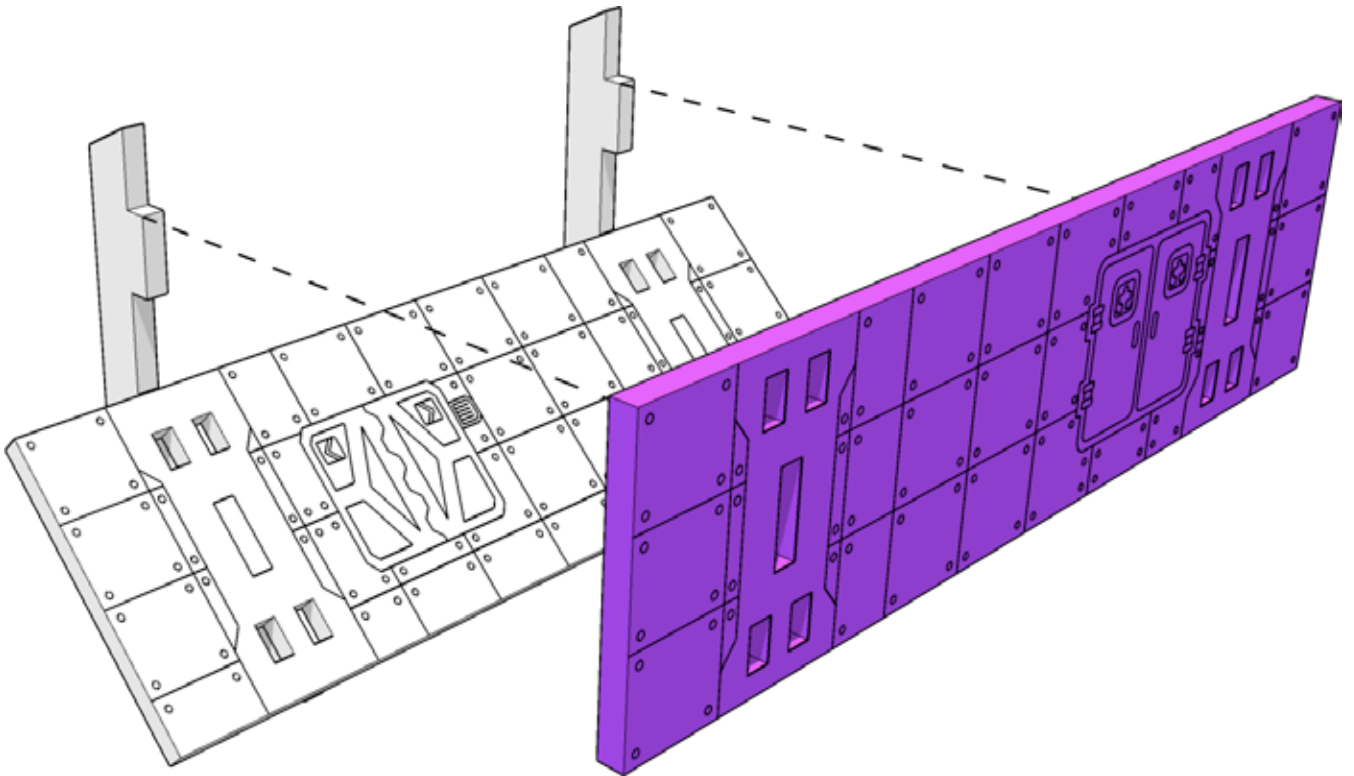



# TABLETOP SCENICS

TTSCW-SFU-112  
Mod.Co.N  
3x2 Straights

11

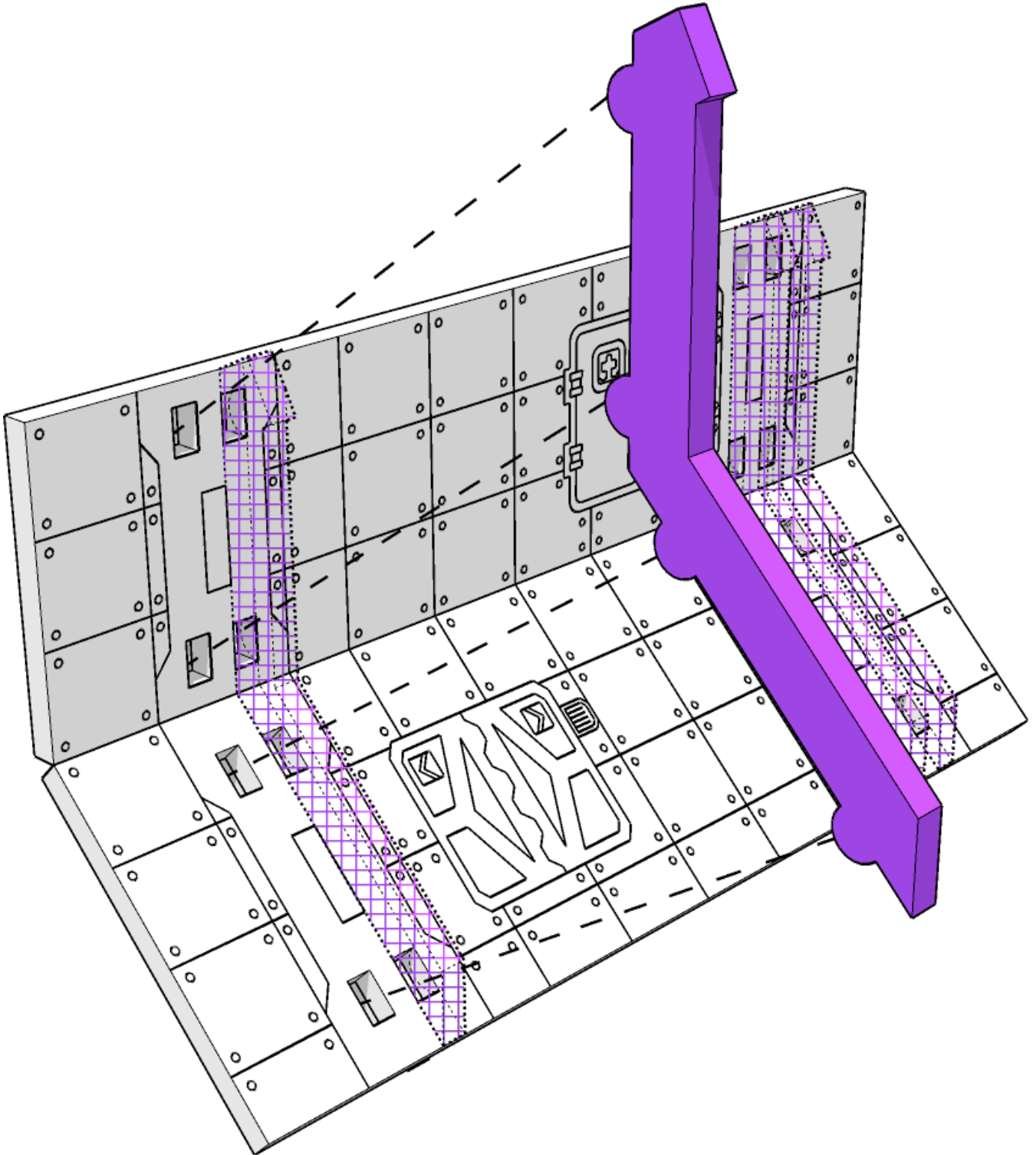



# TABLETOP SCENICS

**TTSCW-SFU-112**  
**Mod.Co.N**  
**3x2 Straights**

**12**

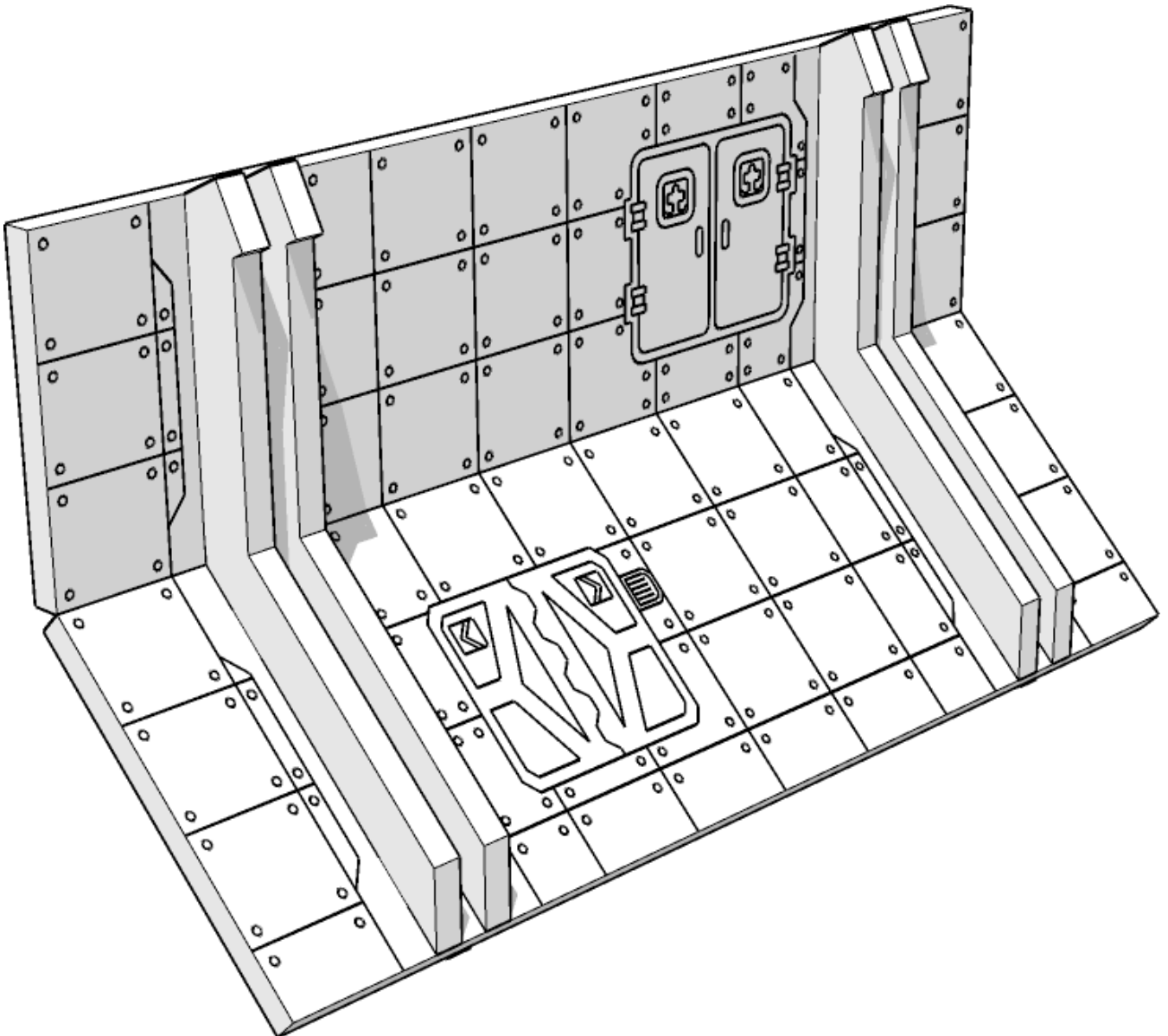



# TABLETOP SCENICS

**TTSCW-SFU-112**  
**Mod.Co.N**  
**3x2 Straights**

**13**

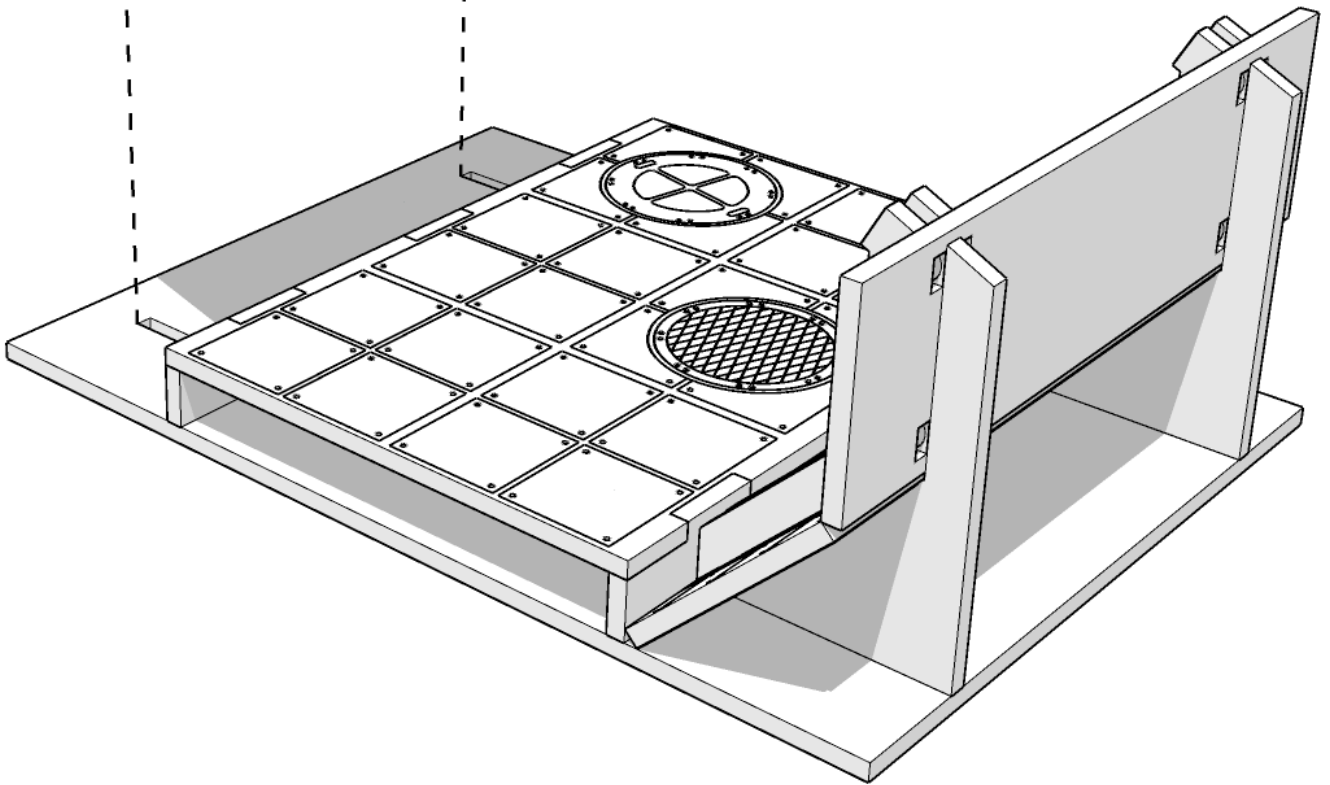
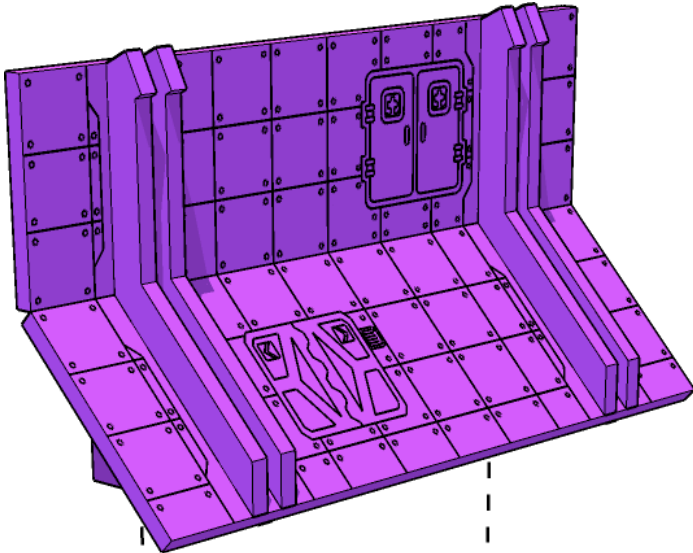



# TABLETOP SCENICS

**TTSCW-SFU-112**  
**Mod.Co.N**  
**3x2 Straights**

**14**

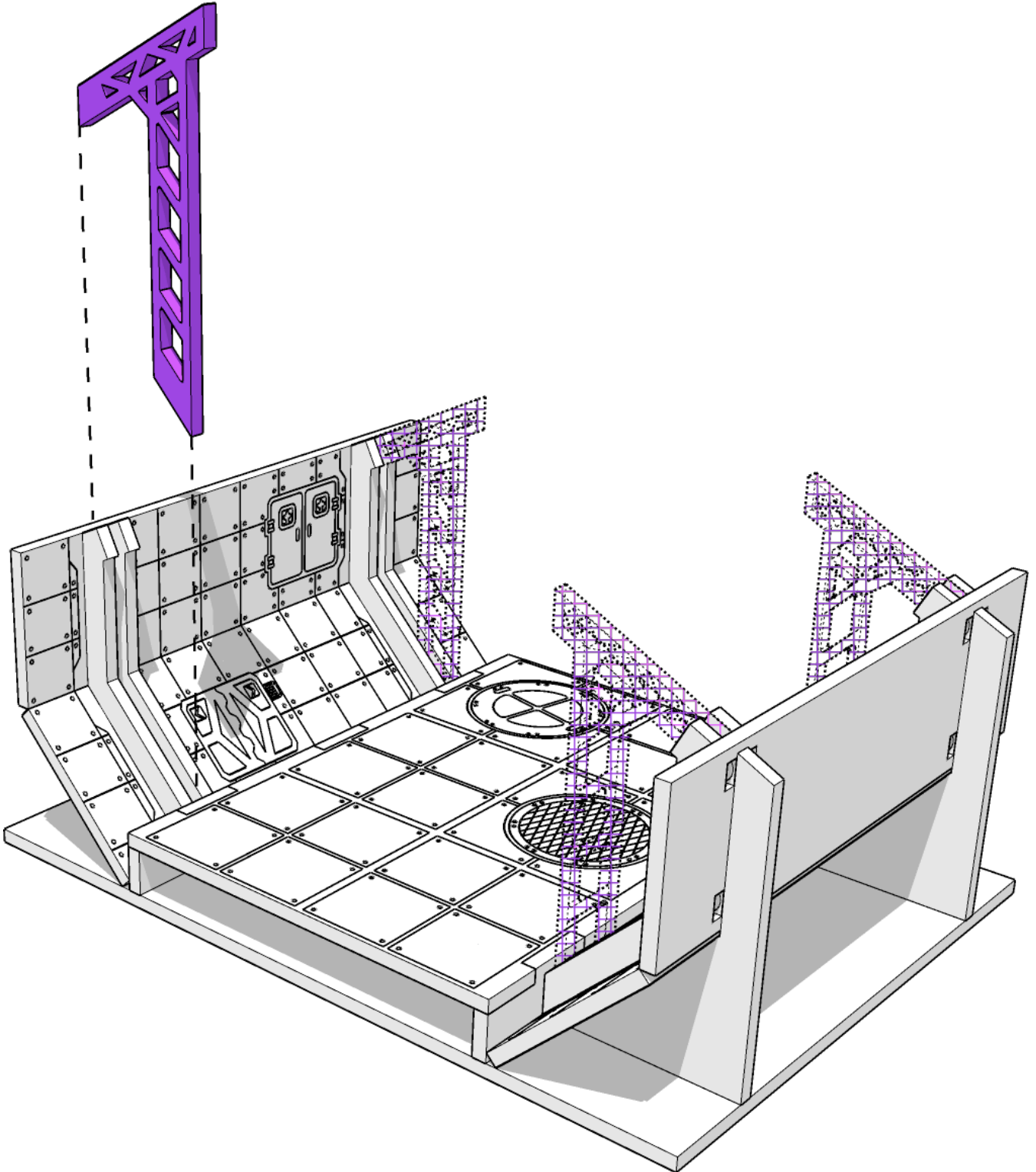



# TABLETOP SCENICS

**TTSCW-SFU-112**  
**Mod.Co.N**  
**3x2 Straights**

**15**

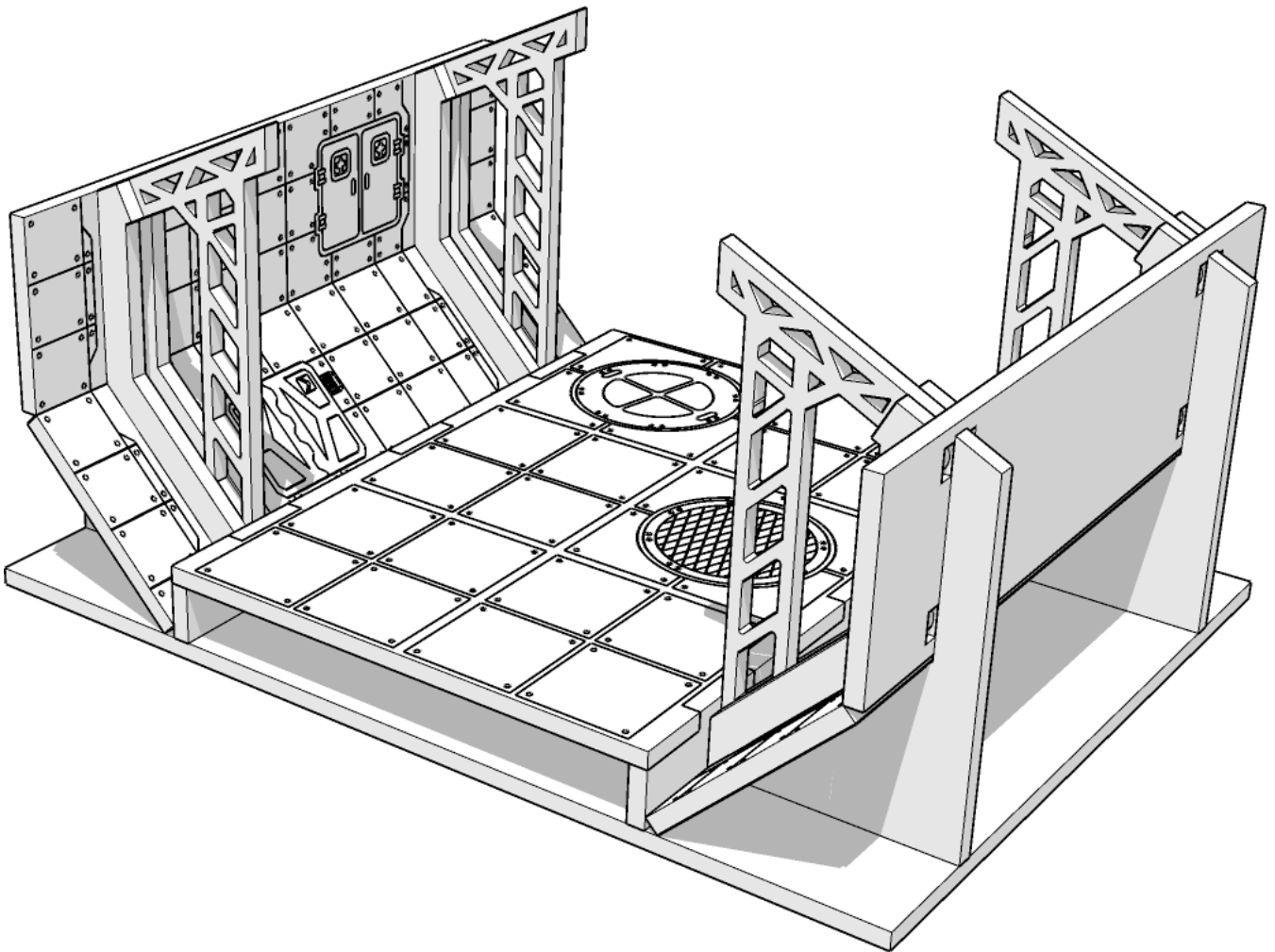

**x2**



# TABLETOP SCENICS

**TTSCW-SFU-112**  
**Mod.Co.N**  
**3x2 Straights**

**16**

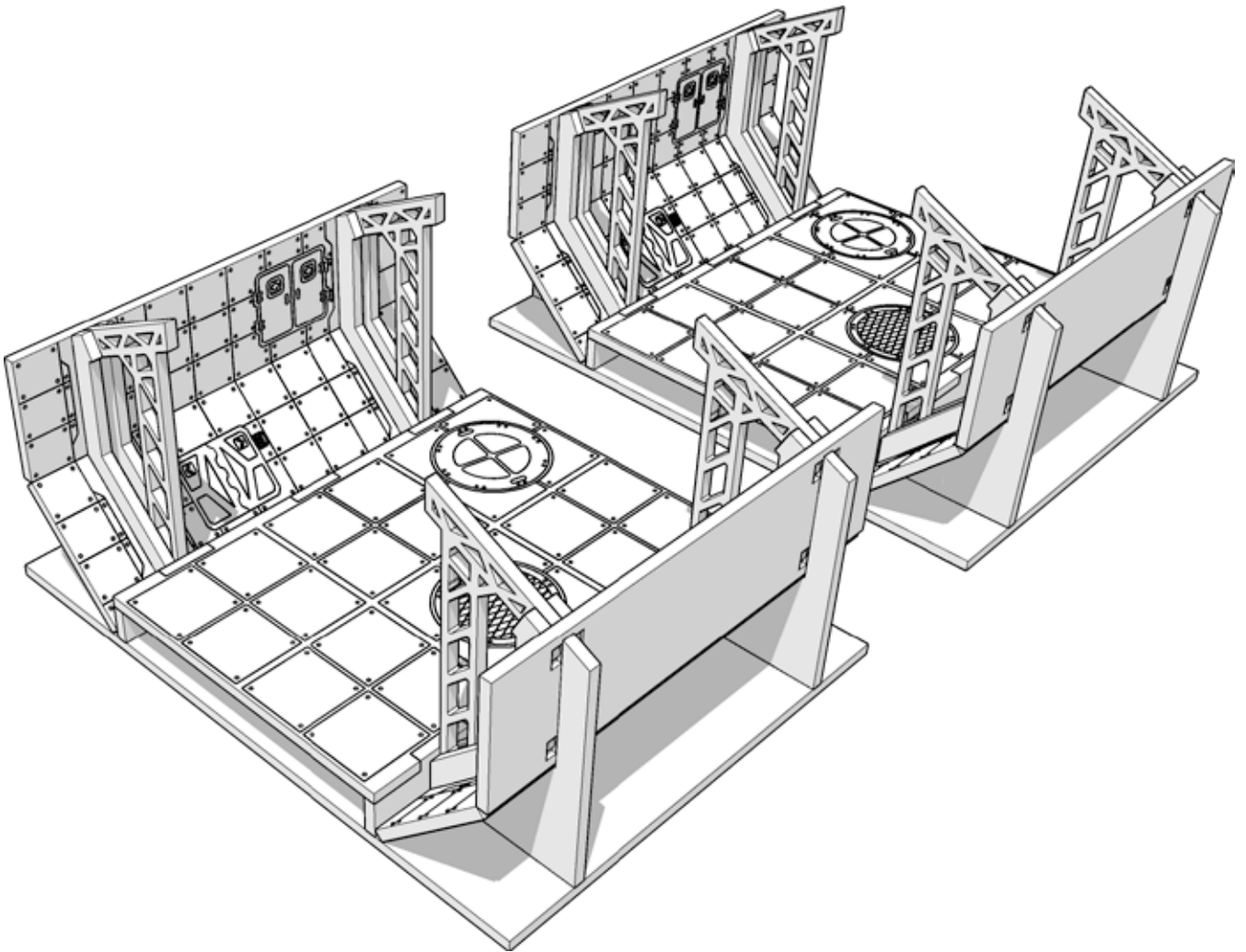

 **TTCOMBAT**