

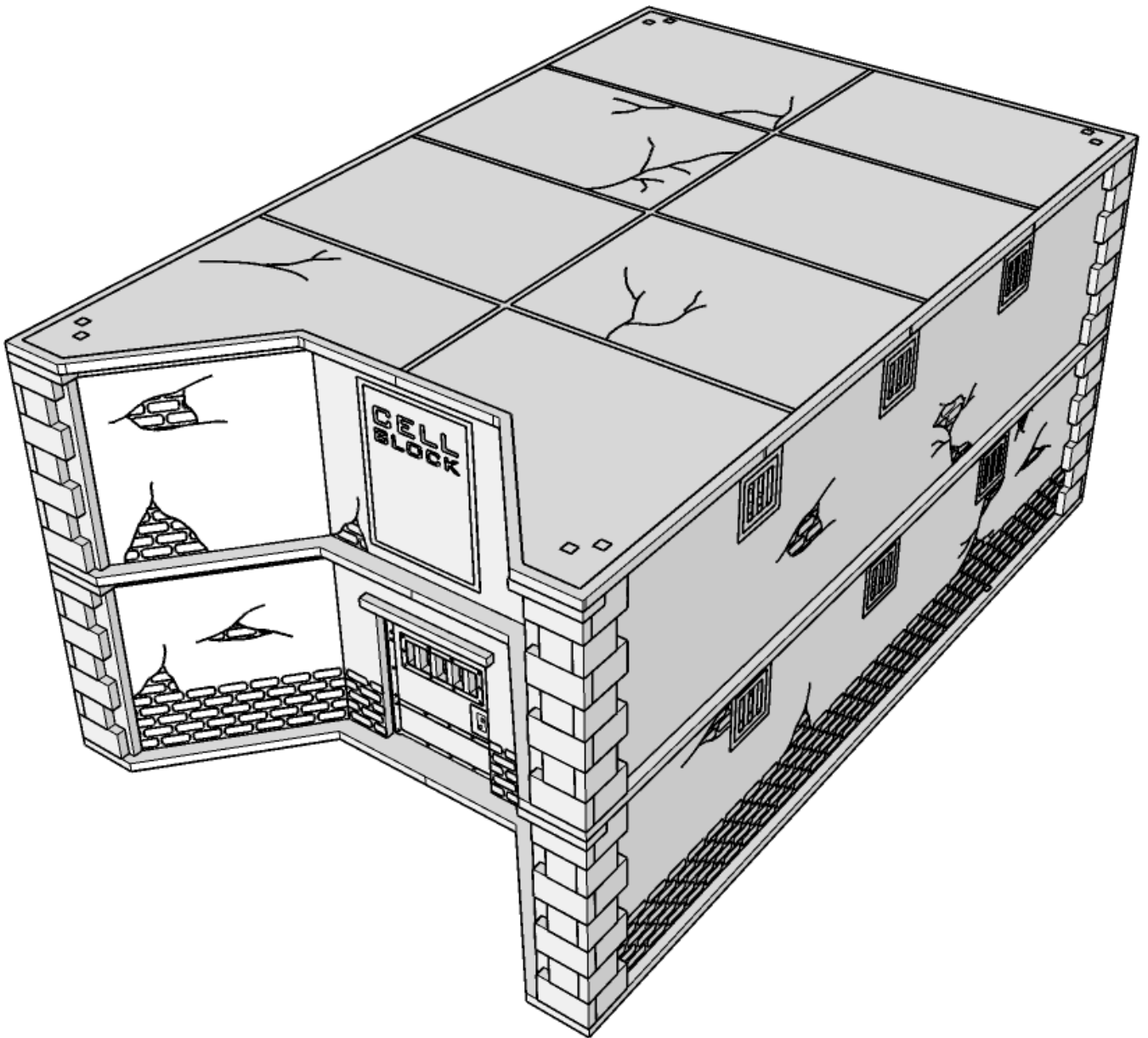

TABLETOP
SCENICS

TTSCW-DCS-158
PCPD: Cell Block



1



 **TTCOMBAT**



These are a series of icons that may be used throughout the instructions to help your assembly. If in doubt, scroll ahead to confirm.



Do not glue

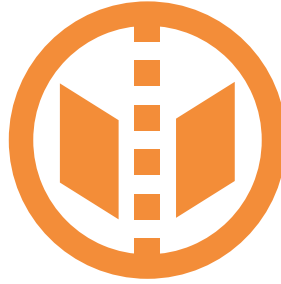

Carefully score
and fold

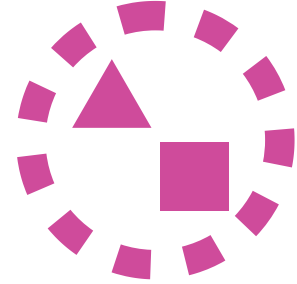

This part or its placement
is completely optional



Look closely at this step.
The process order or part
used, may be specific



Repeat making this
part for the specified
number of times

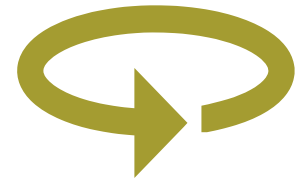

The next instruction step
will be the same
assembly but from
a different angle

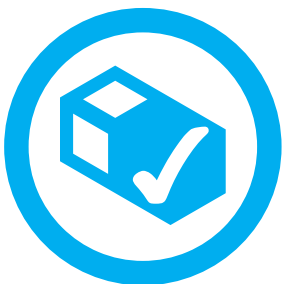

Sub-assembly complete.
This smaller construction
is ready to add to the
main kit



Assembly Complete!
There may be more
optional parts so check
to the very end
of the instructions



FRAGILE: DO NOT BEND.
"Bendy wood" is designed
to curve around
a designed frame only.

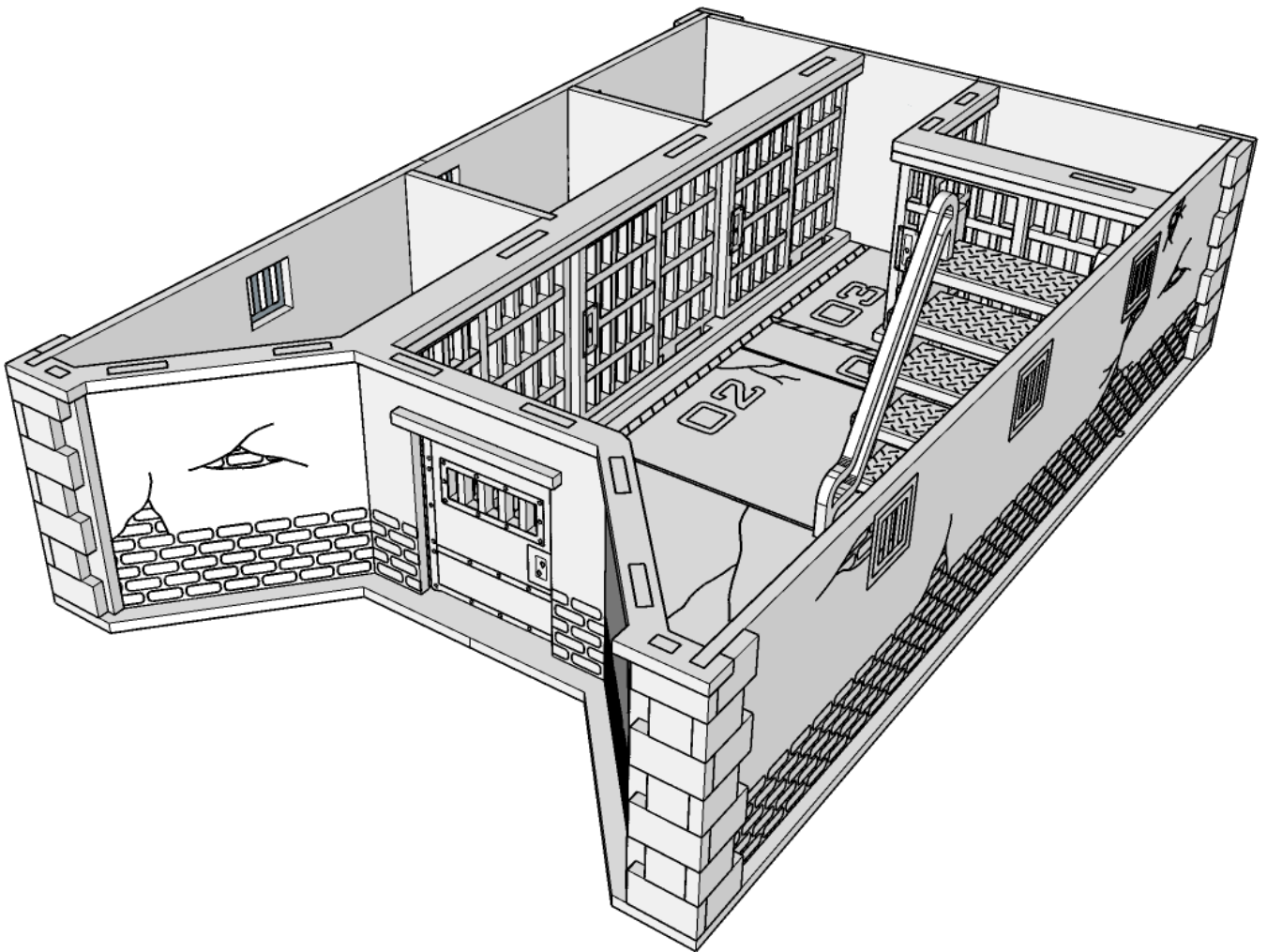



TABLETOP
SCENICS

TTSCW-DCS-158
PCPD: Cell Block

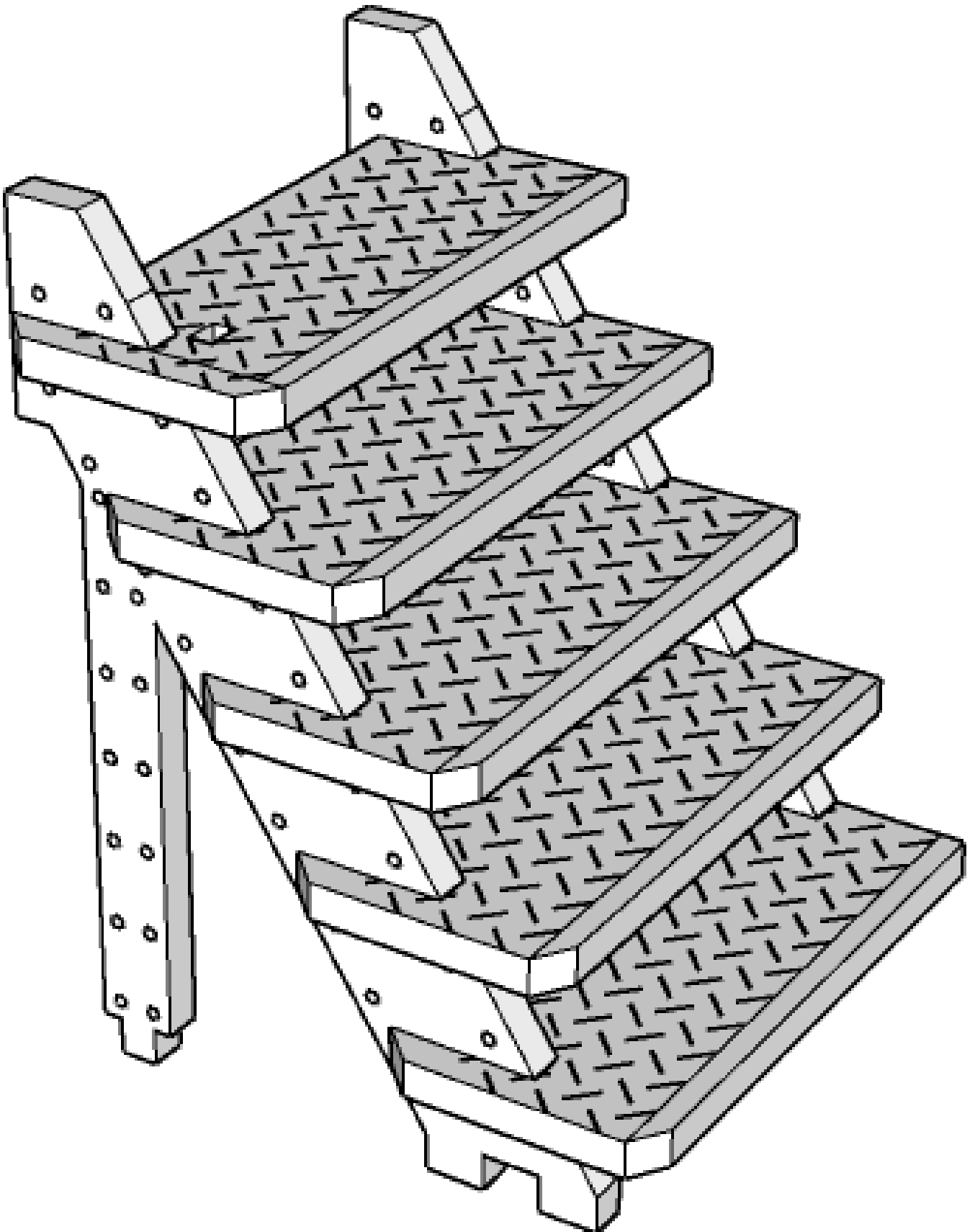

4

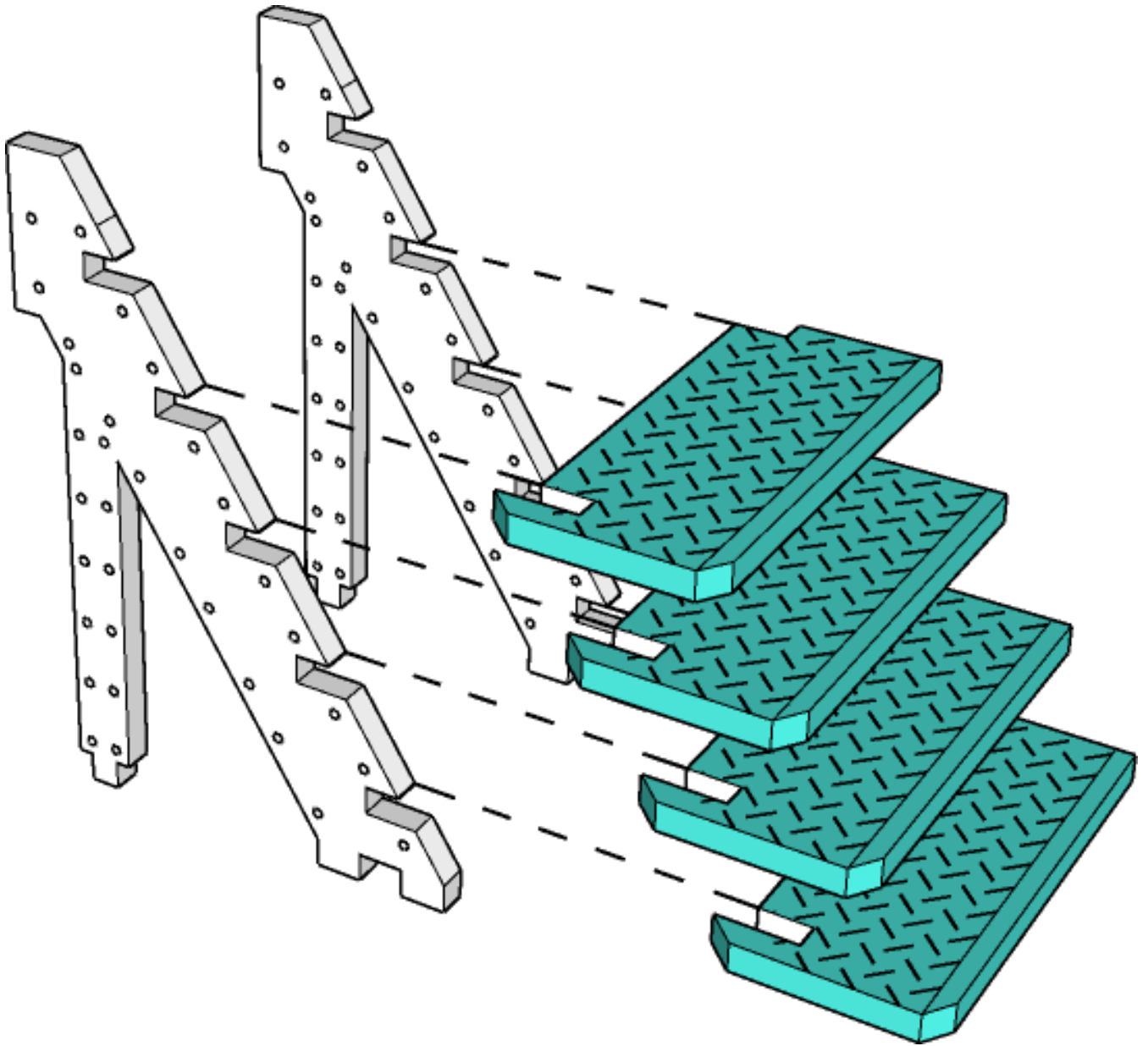



TABLETOP
SCENICS

TTSCW-DCS-158
PCPD: Cell Block

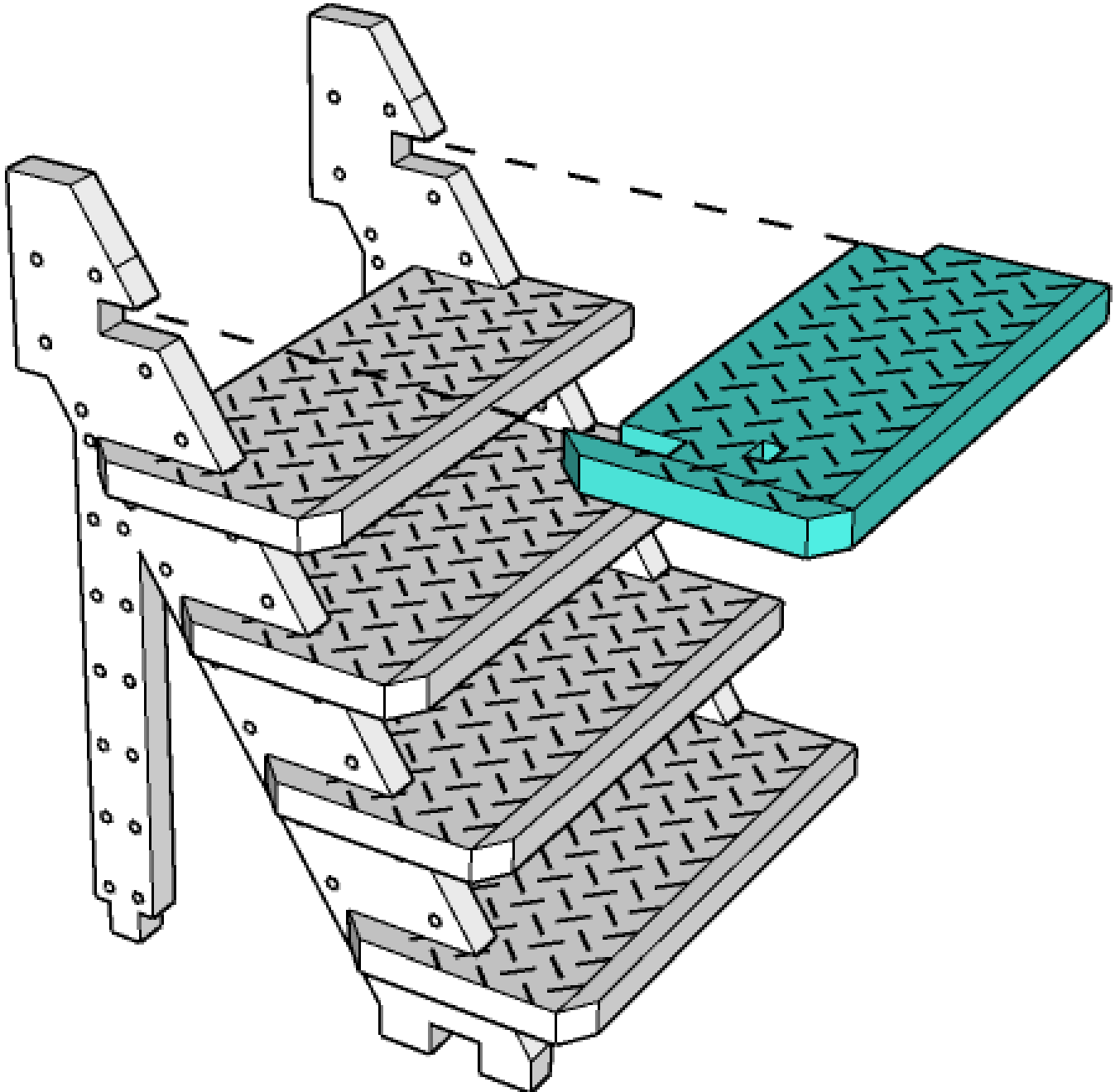



TABLETOP
SCENICS

TTSCW-DCS-158
PCPD: Cell Block

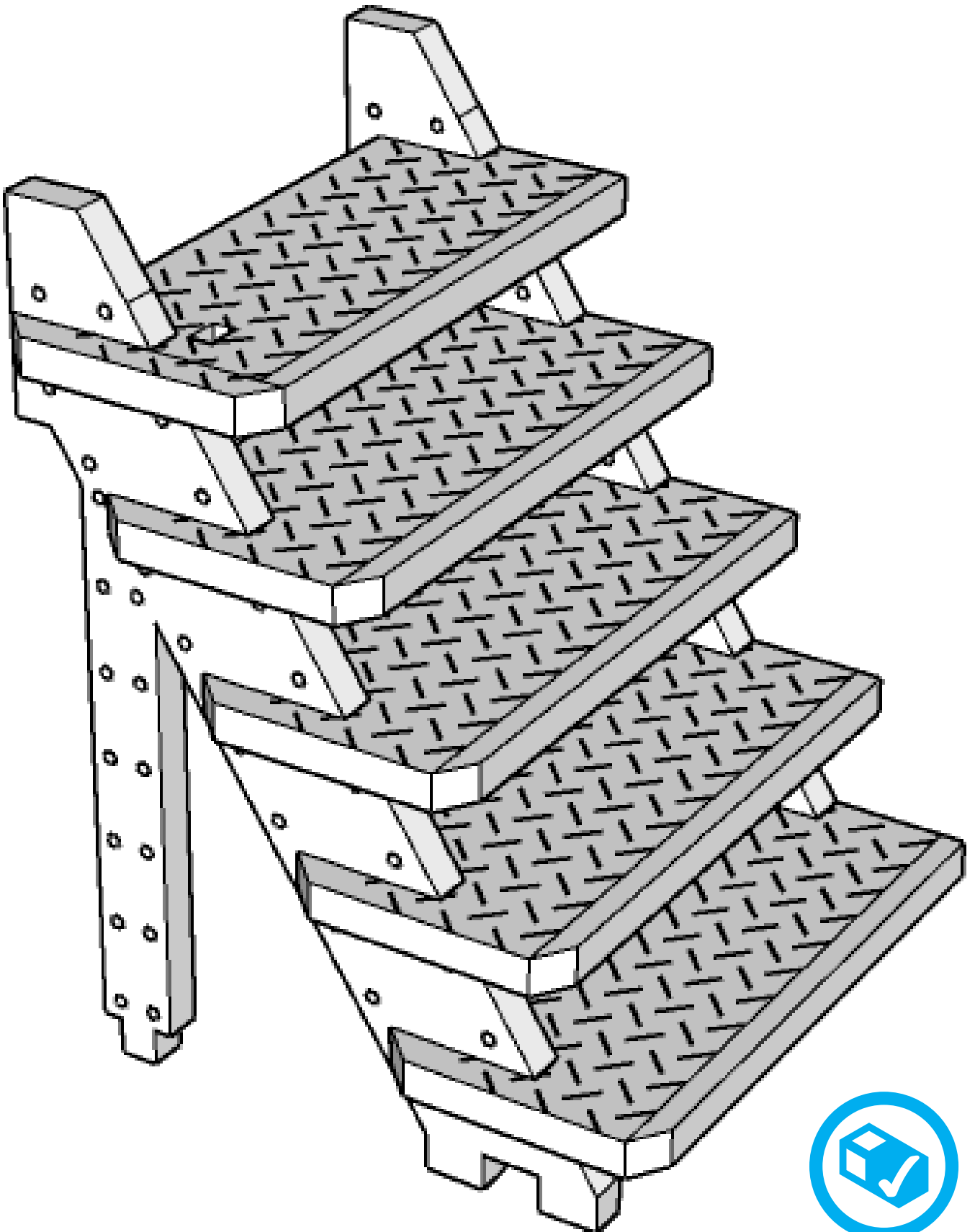

7

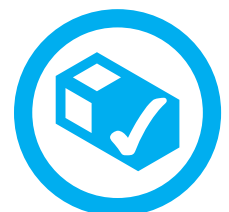

 **TTCOMBAT**

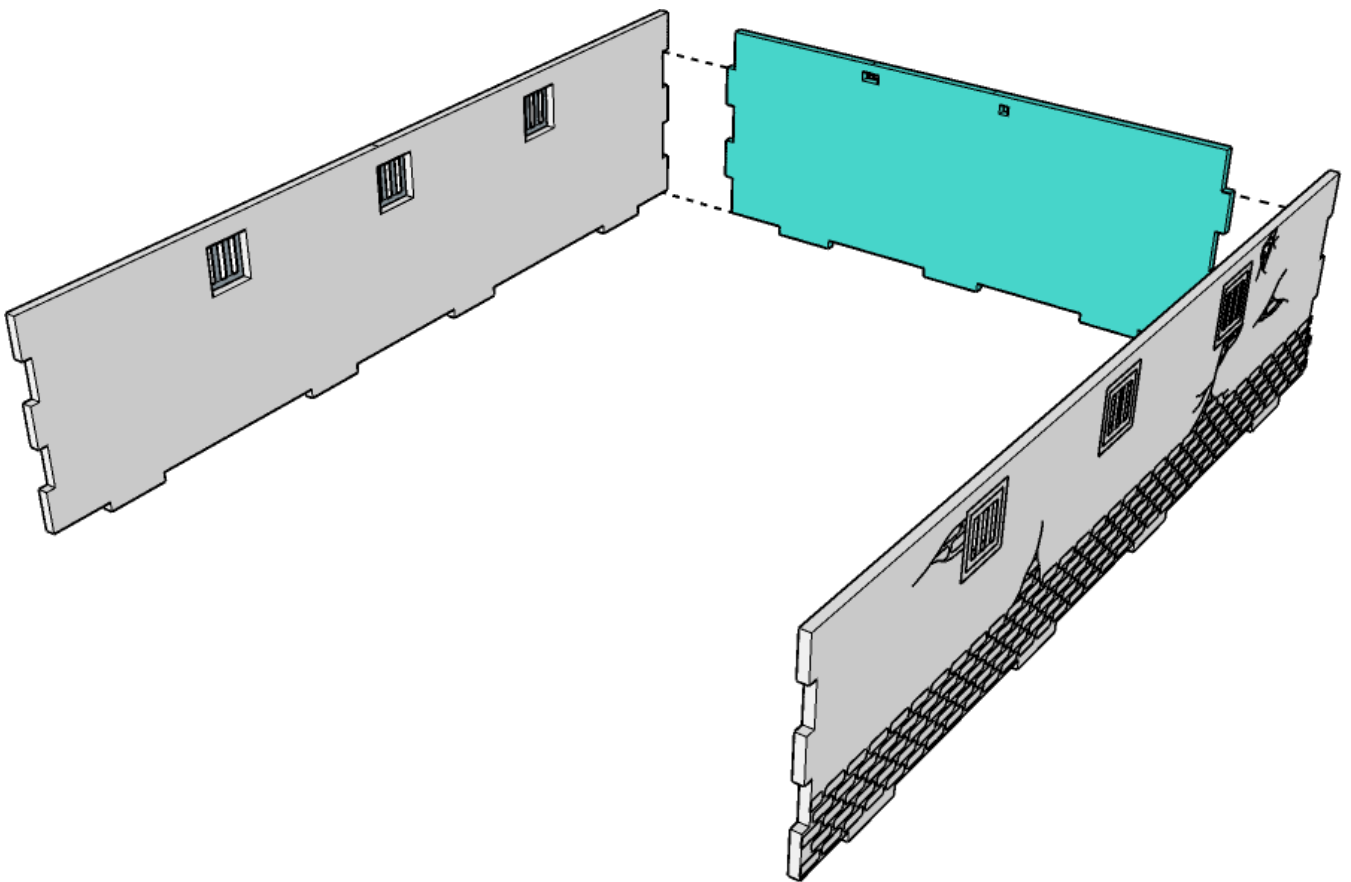

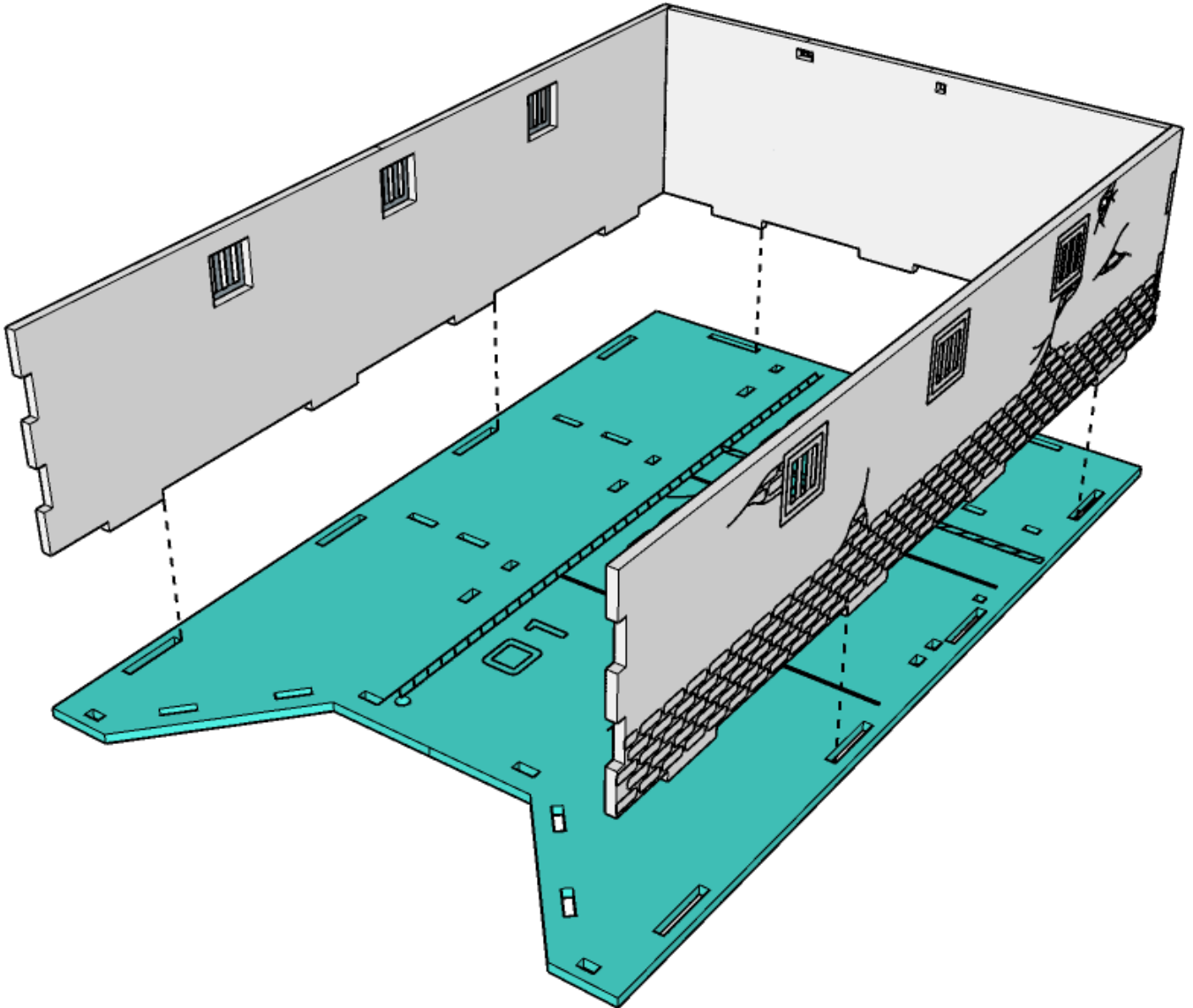

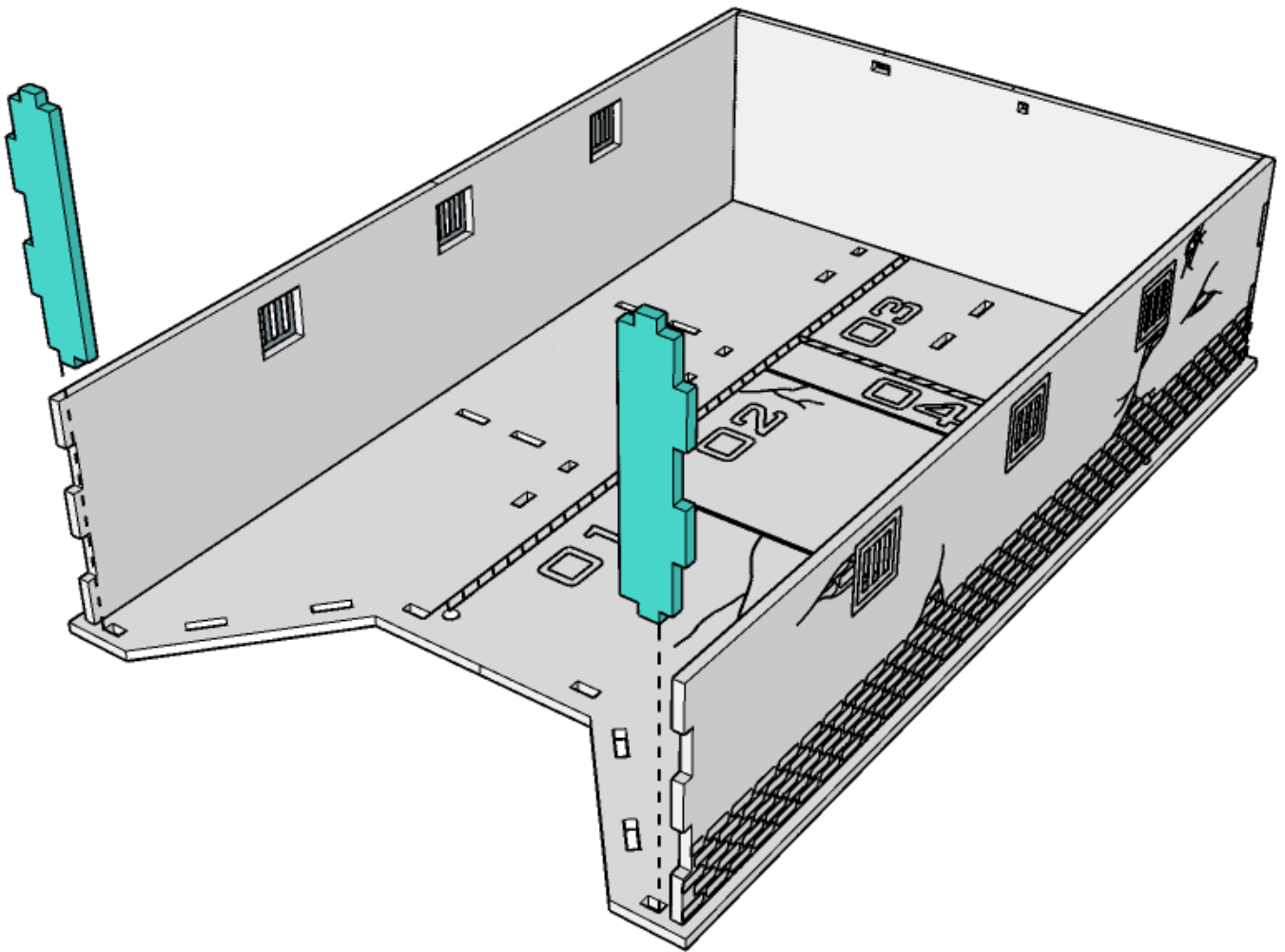

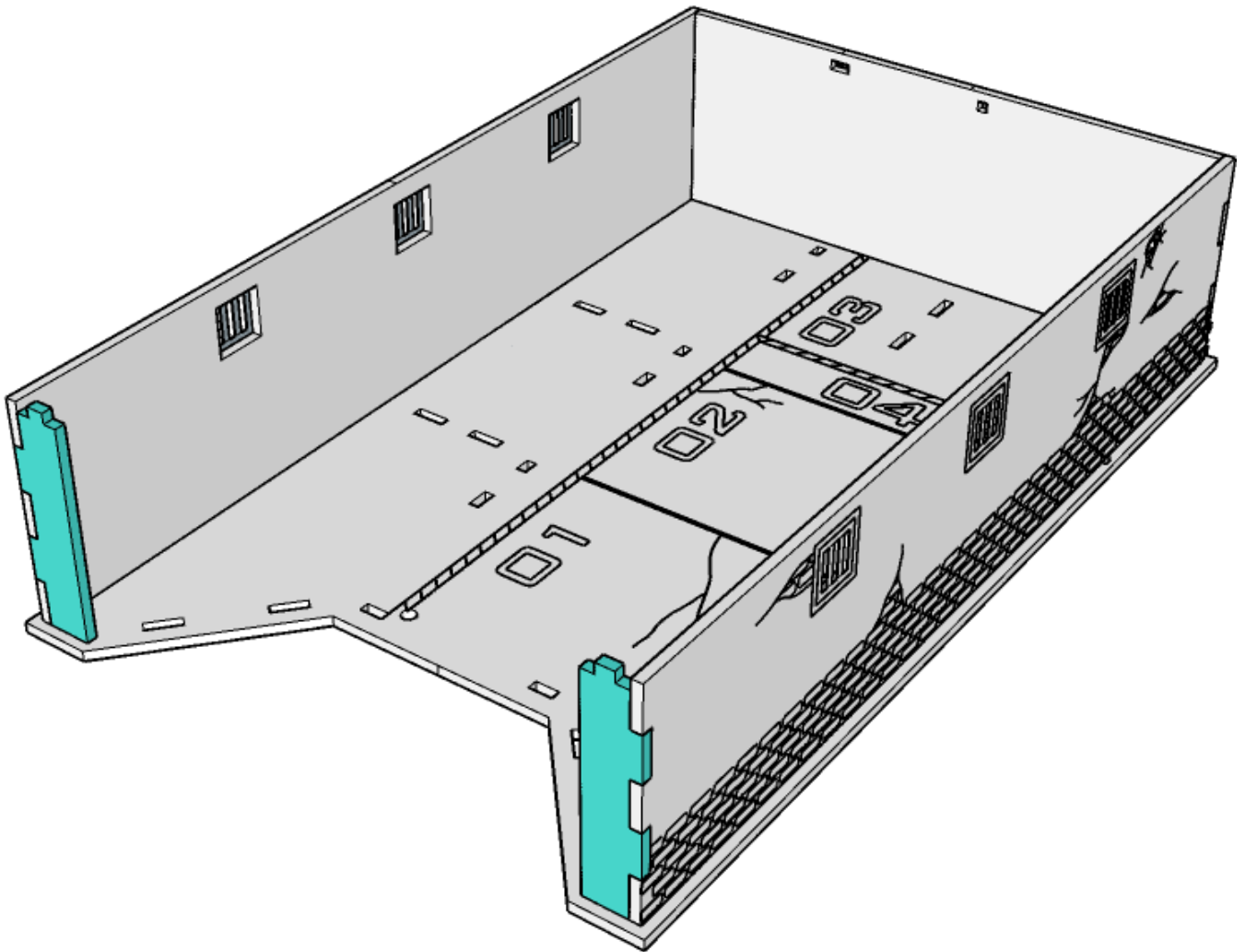

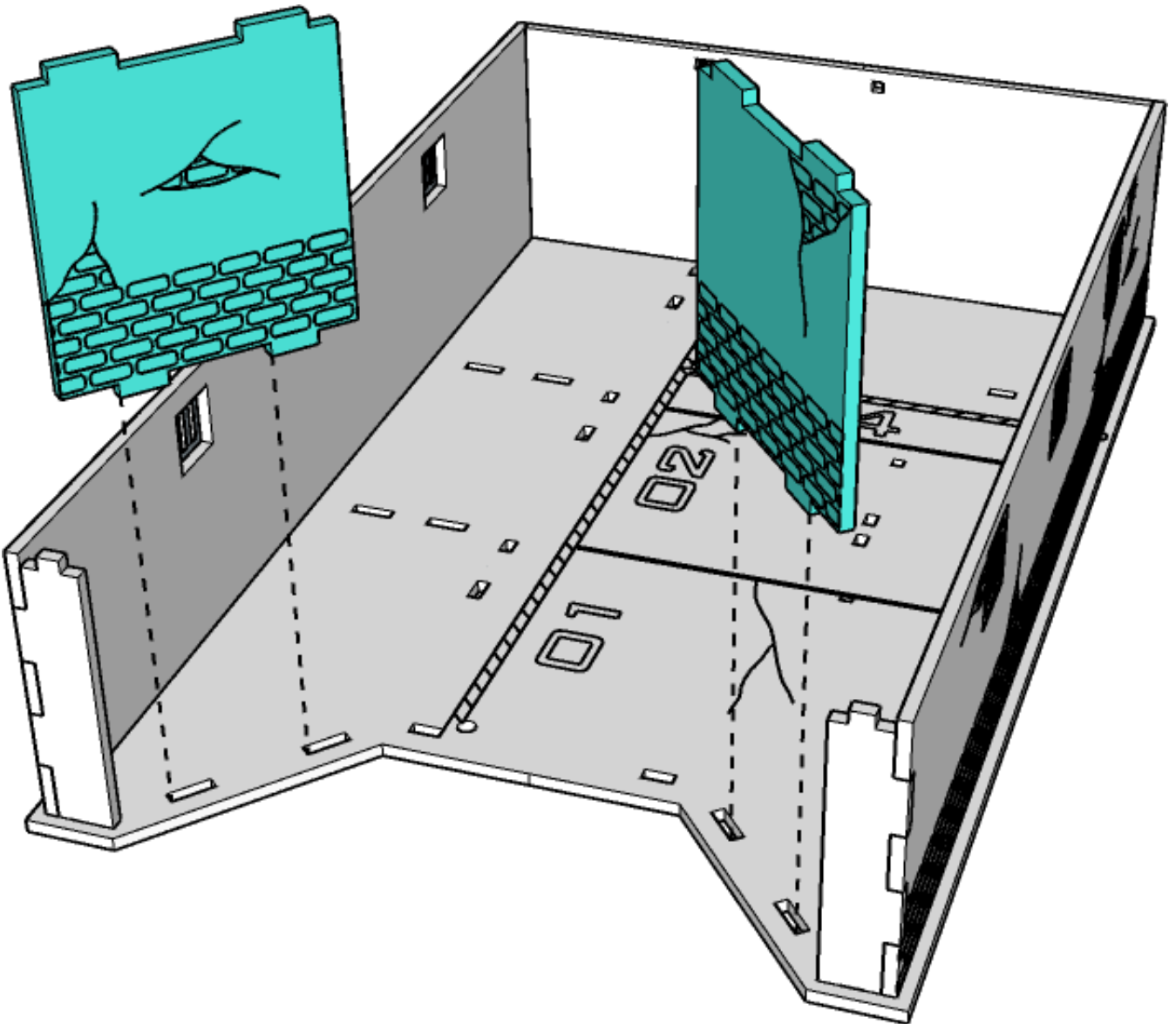

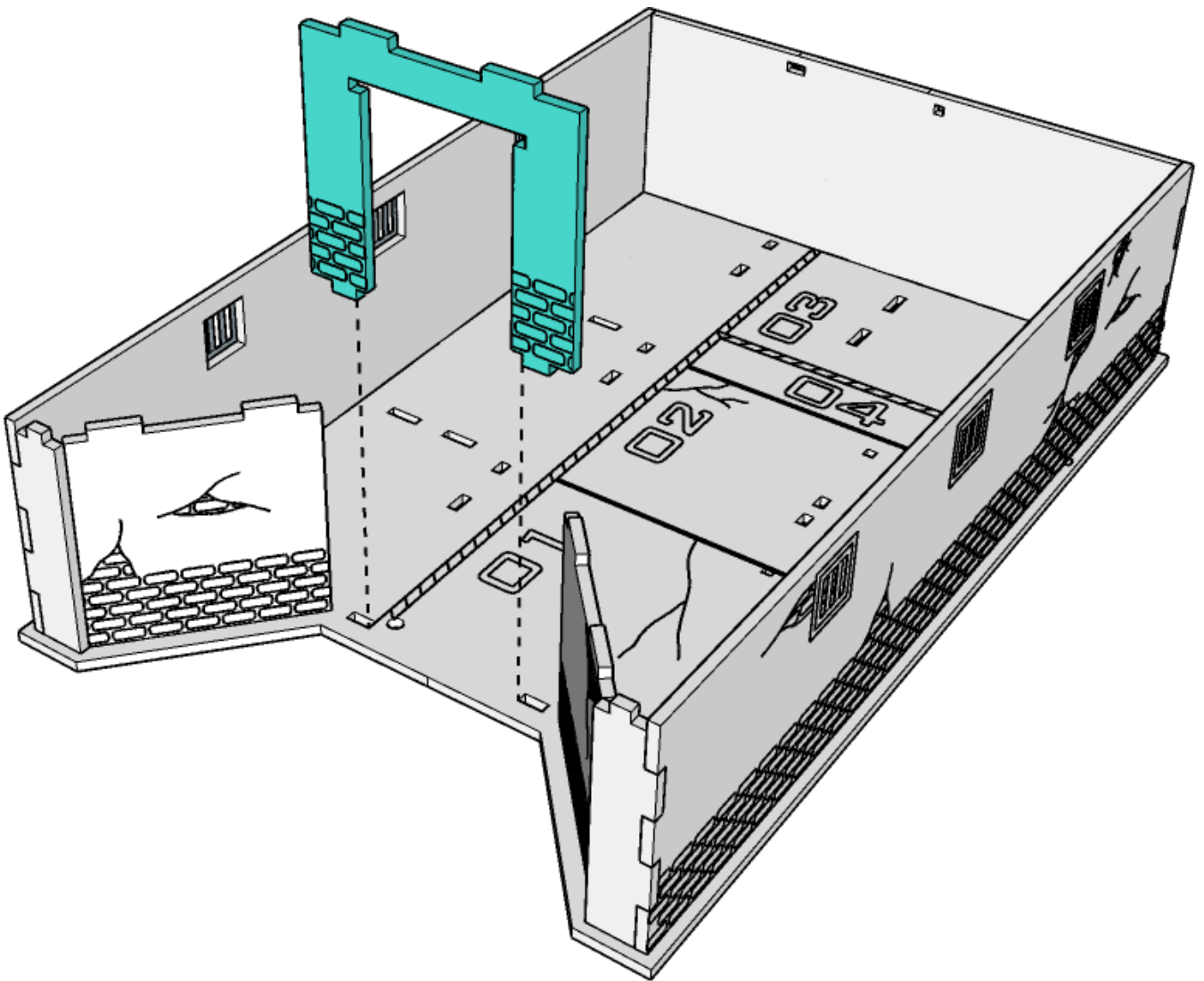



TABLETOP
SCENICS

TTSCW-DCS-158
PCPD: Cell Block

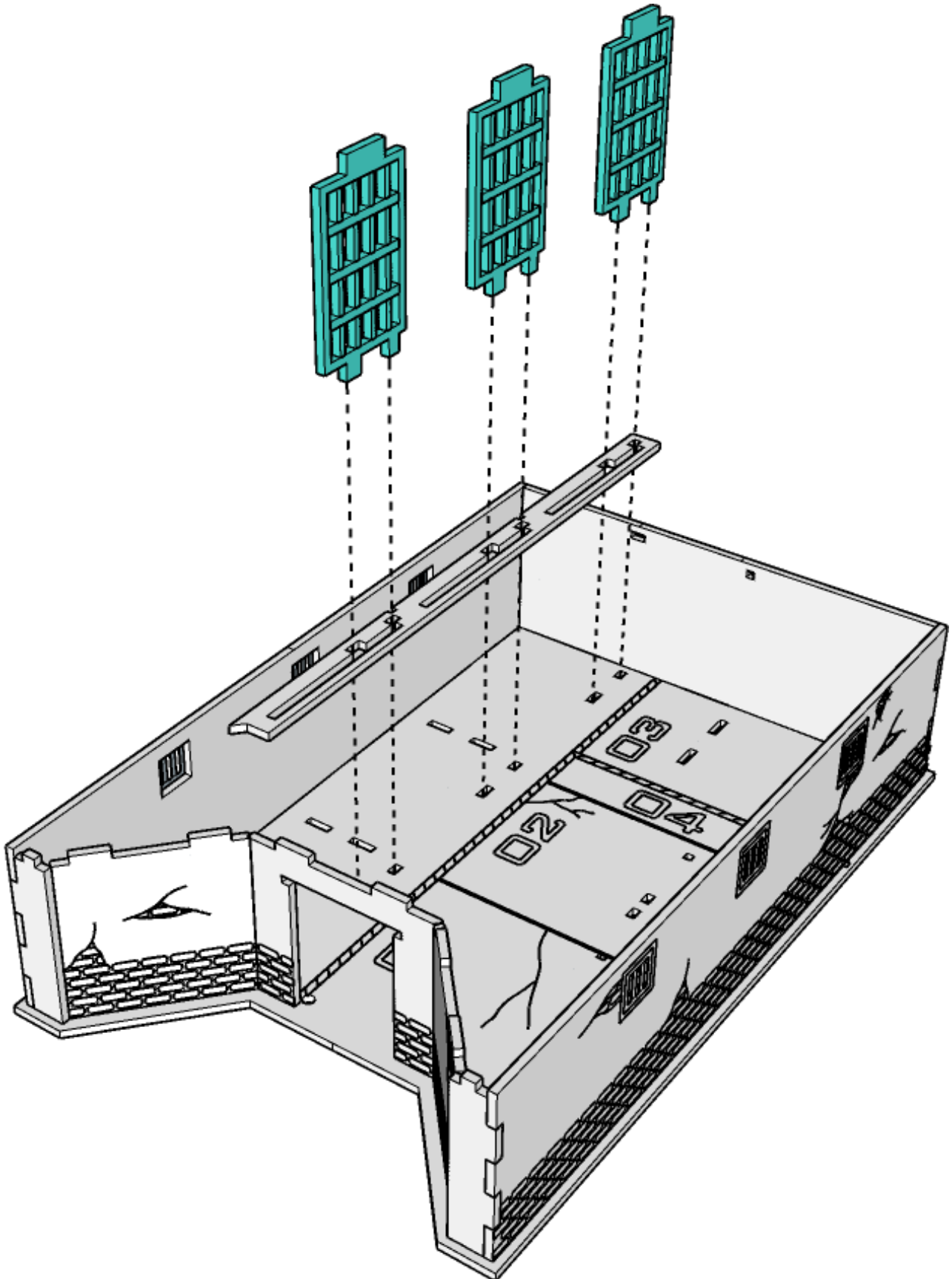

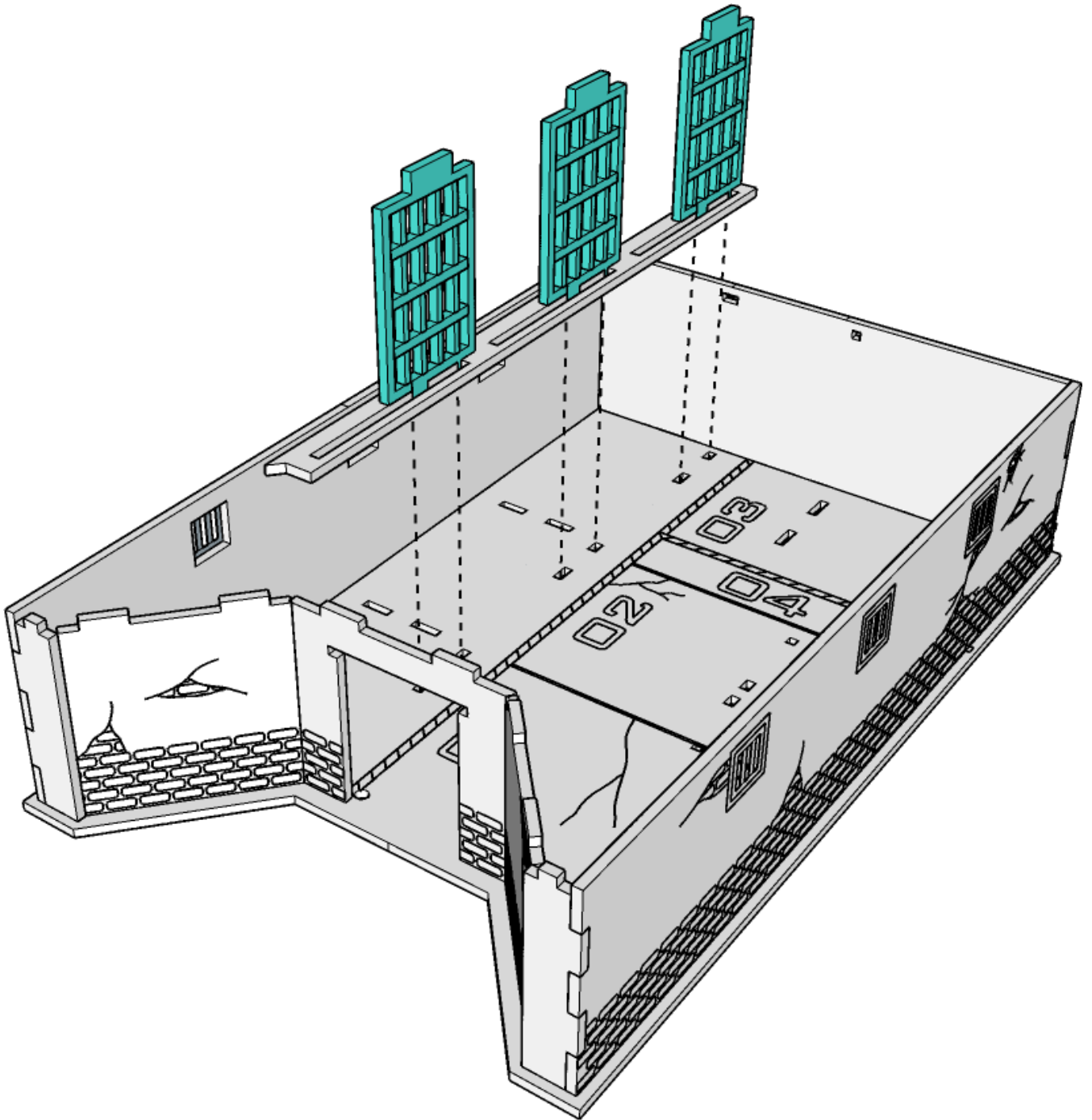

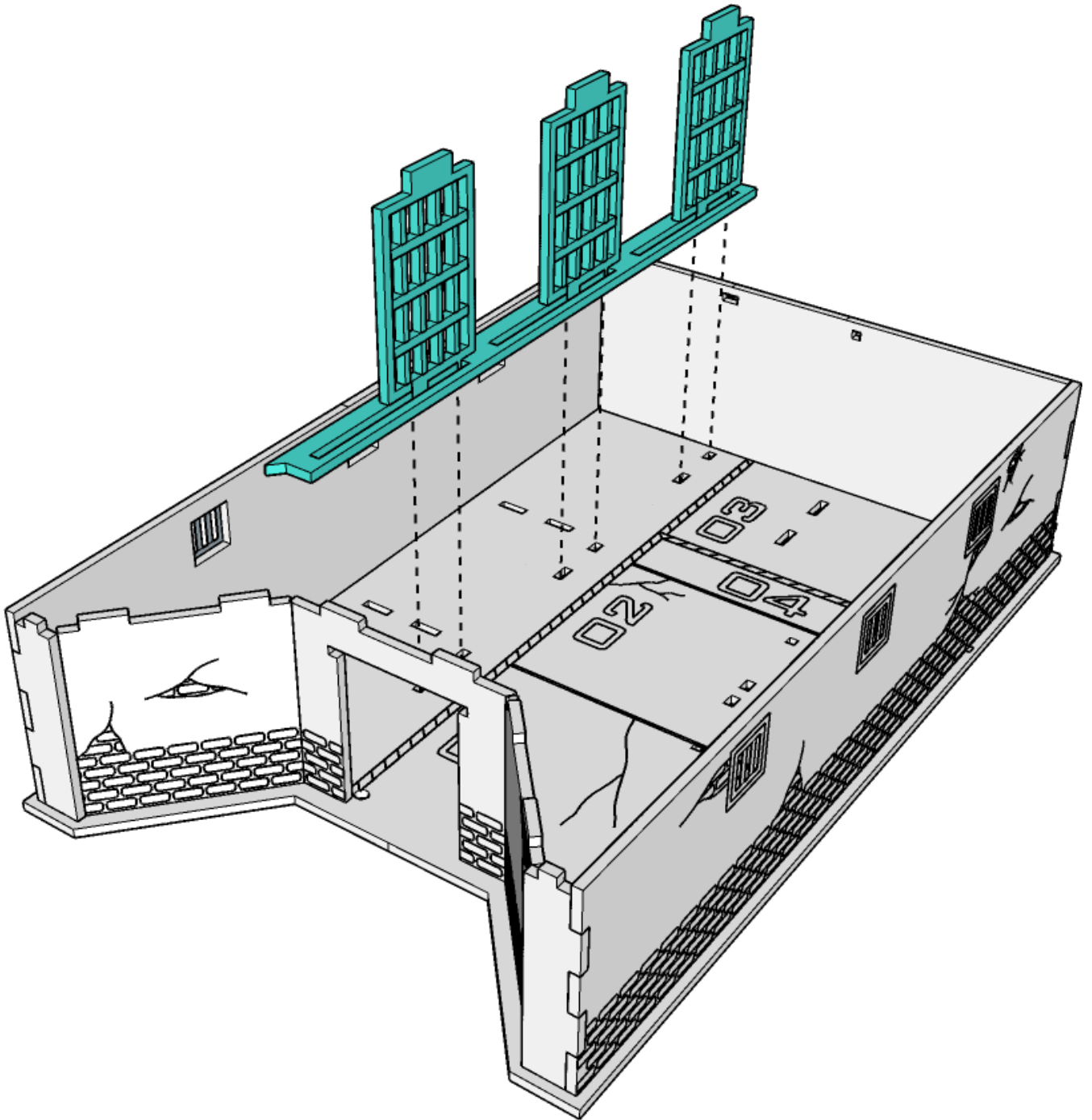

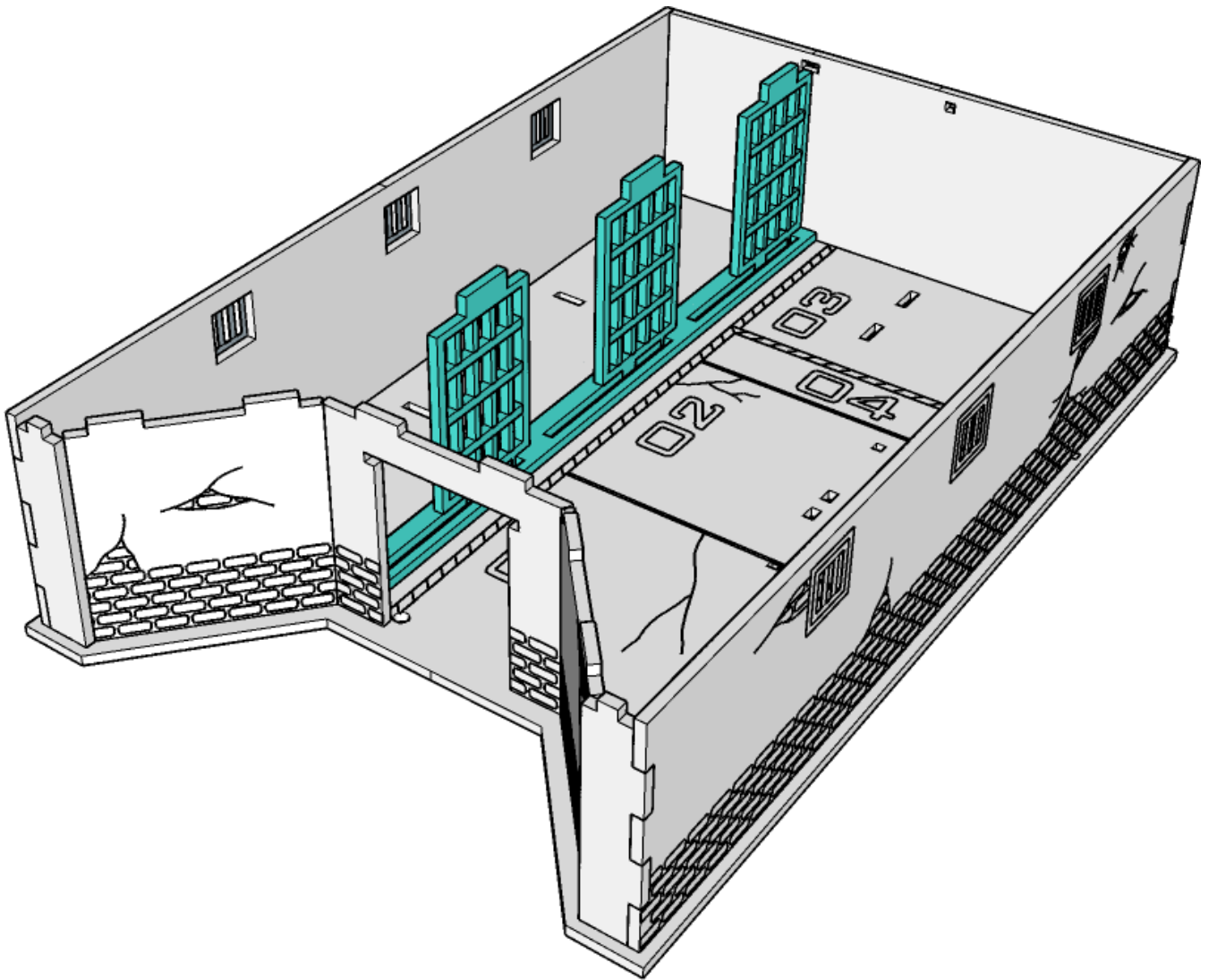

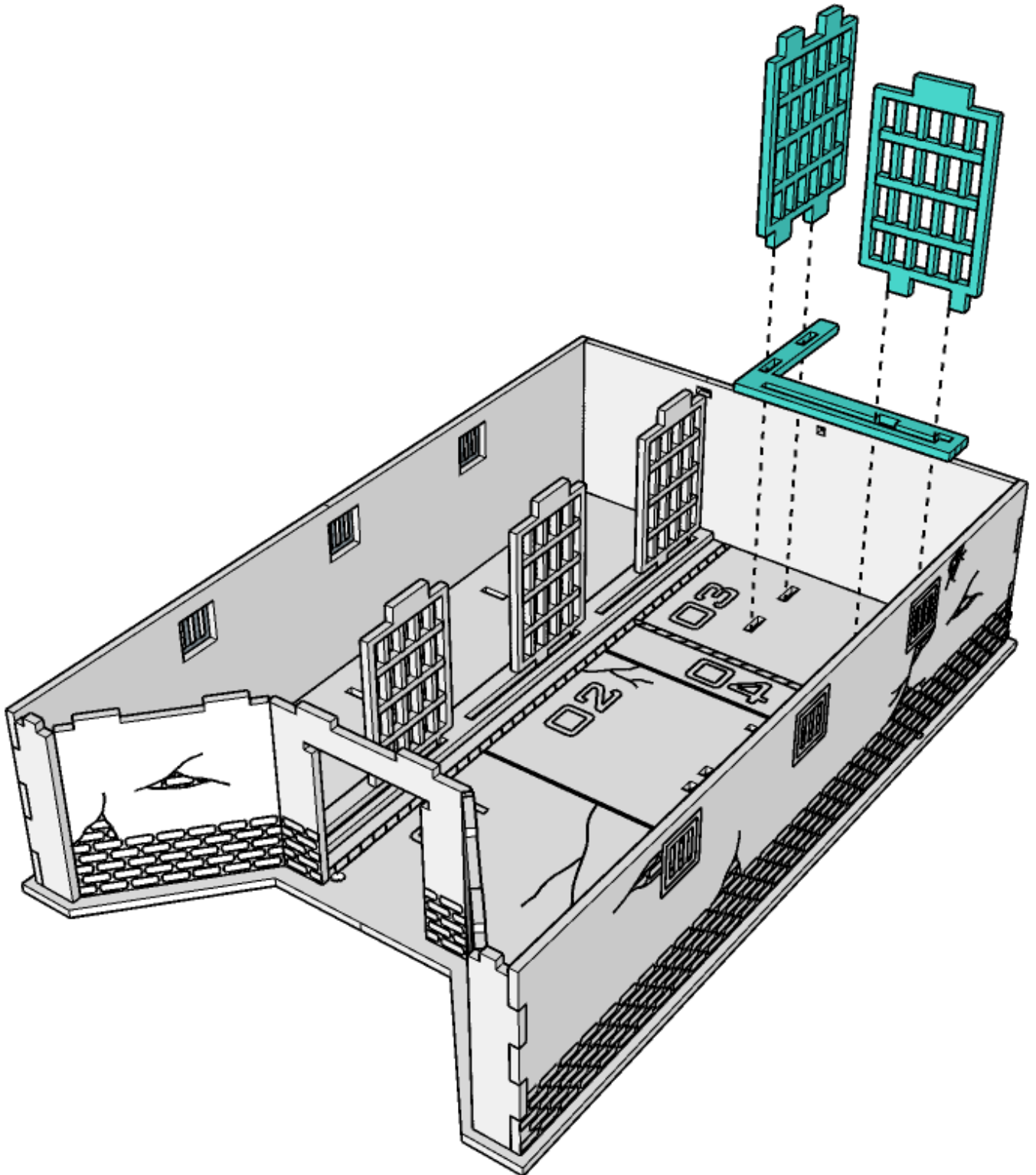

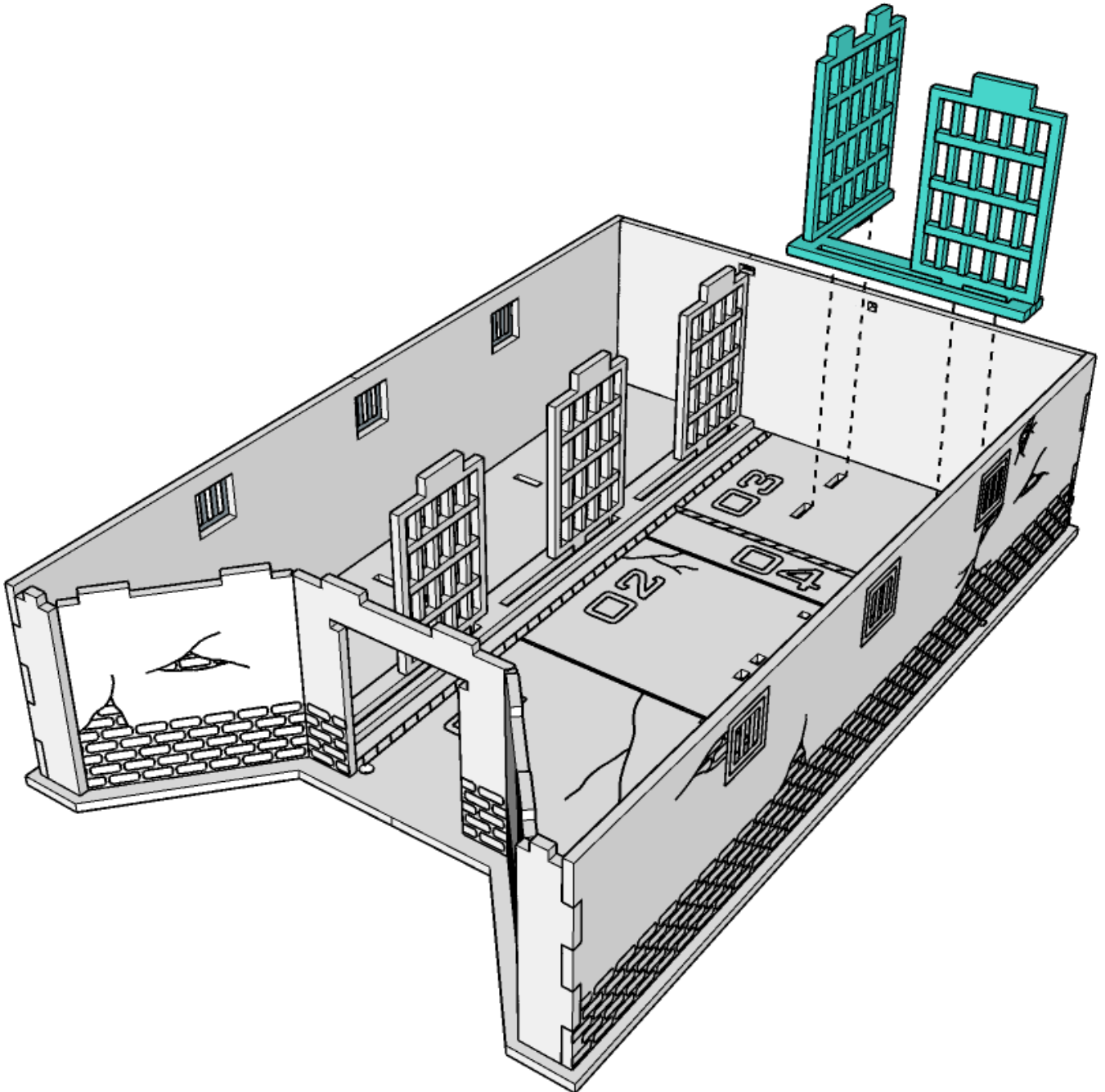



TABLETOP SCENICS

TTSCW-DCS-158
PCPD: Cell Block

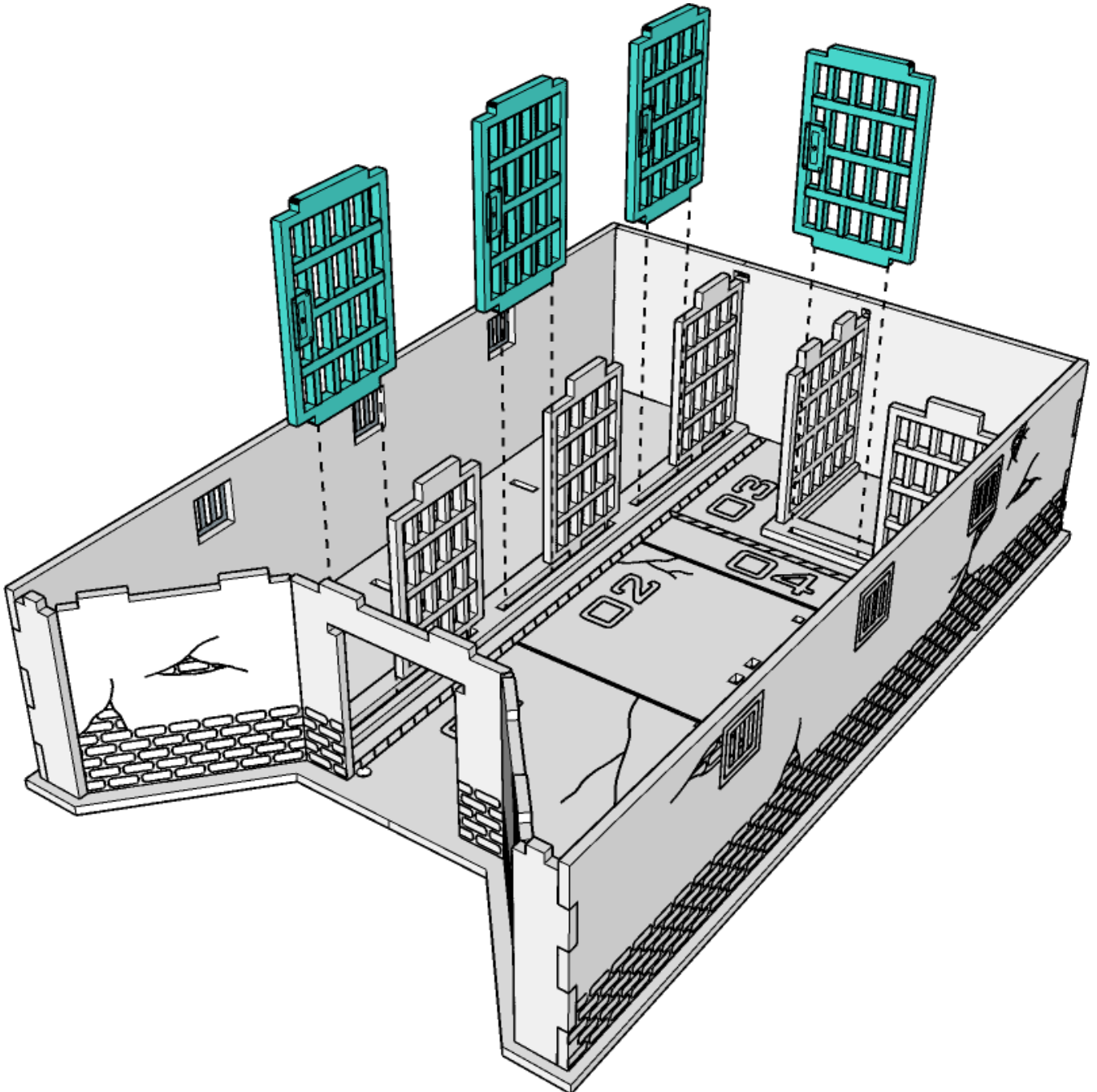

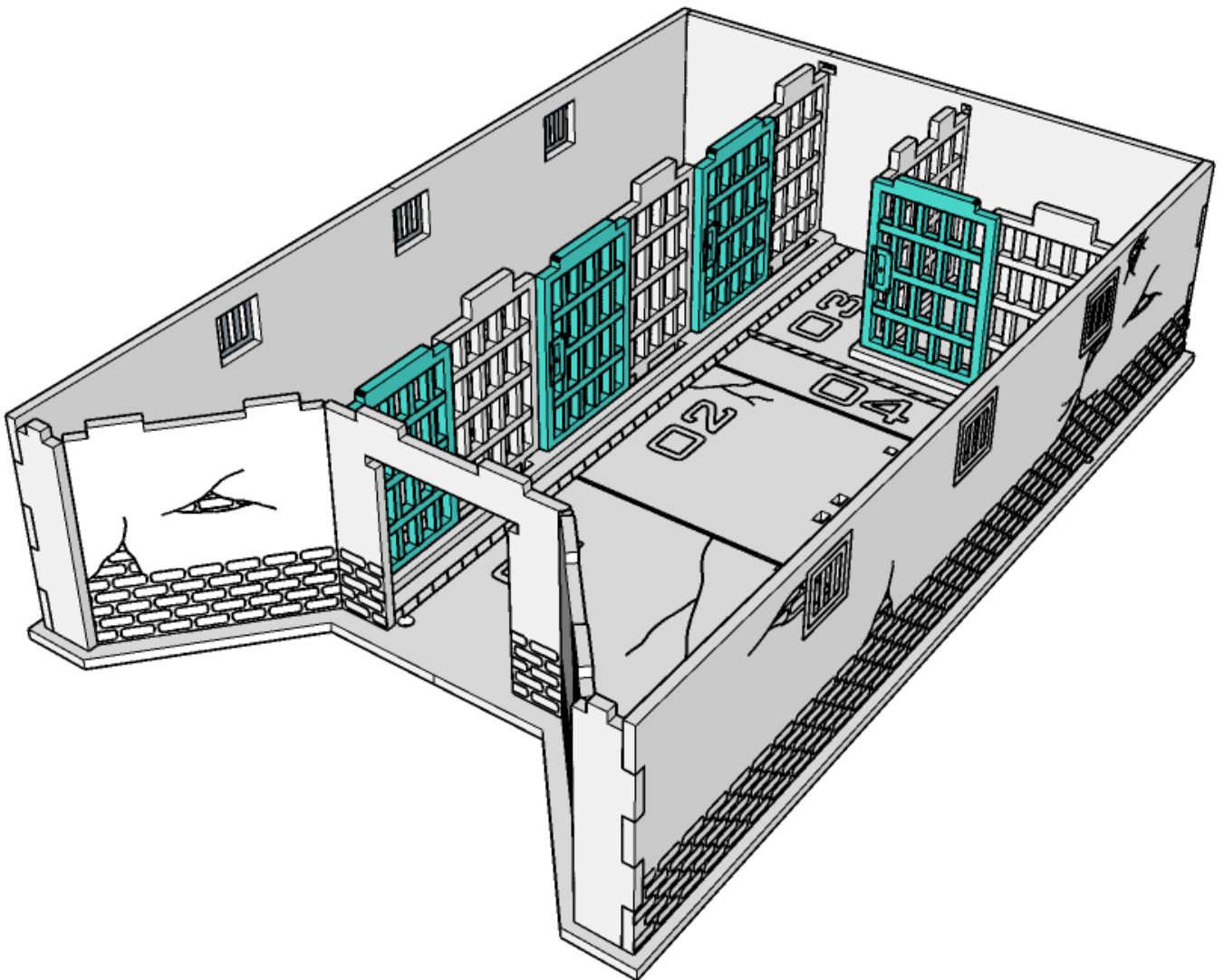



TABLETOP
SCENICS

TTSCW-DCS-158
PCPD: Cell Block

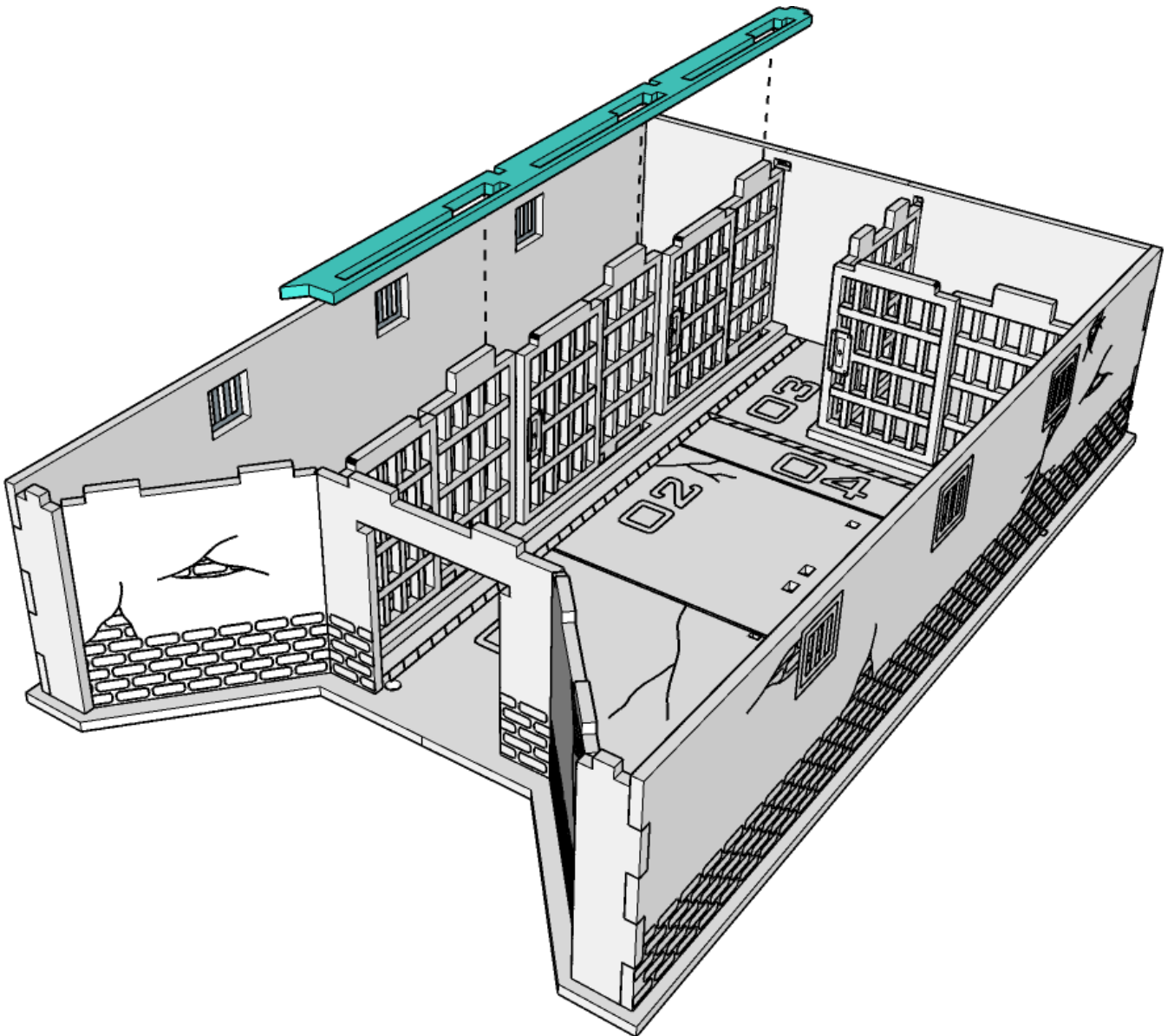



**TABLETOP
SCENICS**

**TTSCW-DCS-158
PCPD: Cell Block**

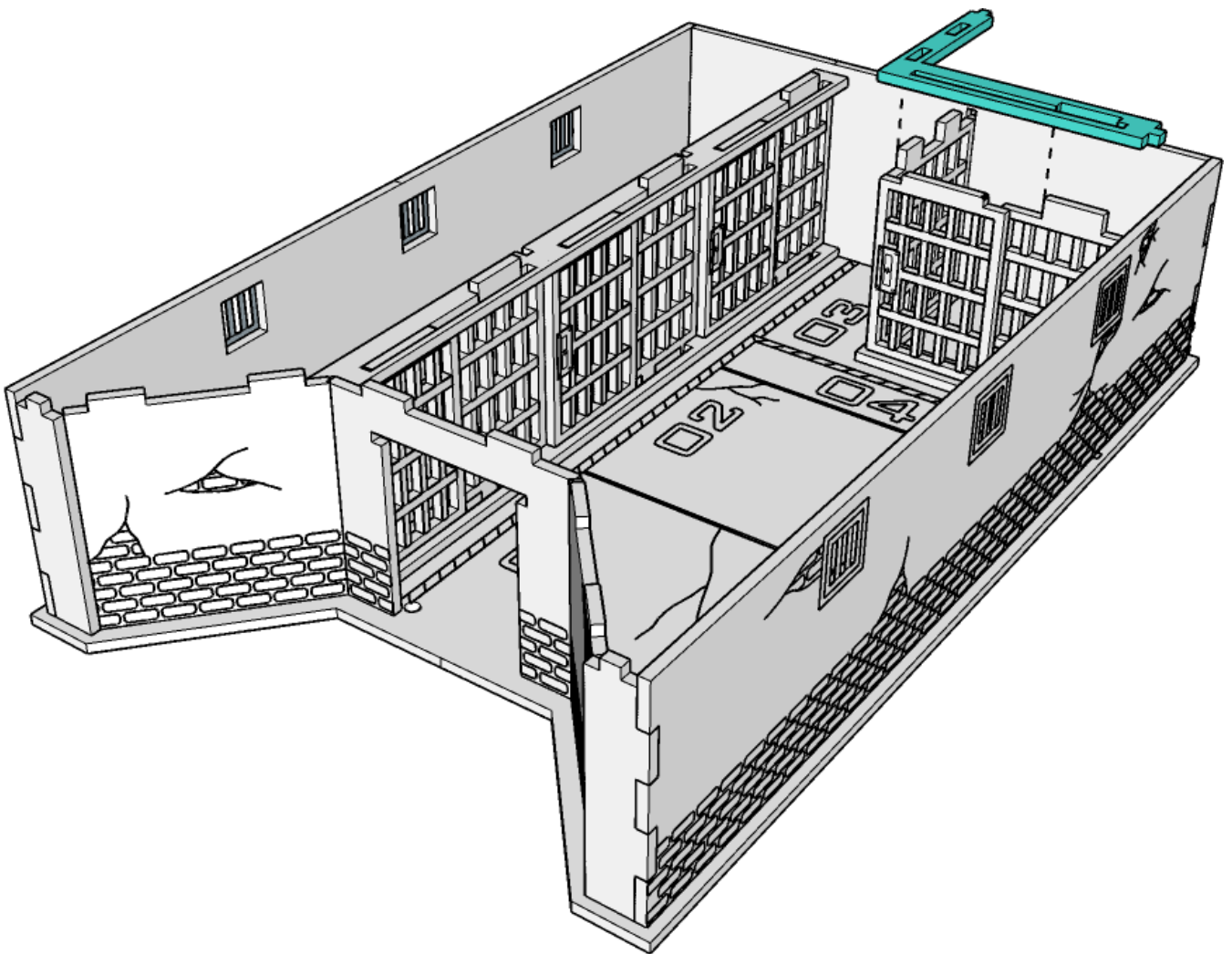

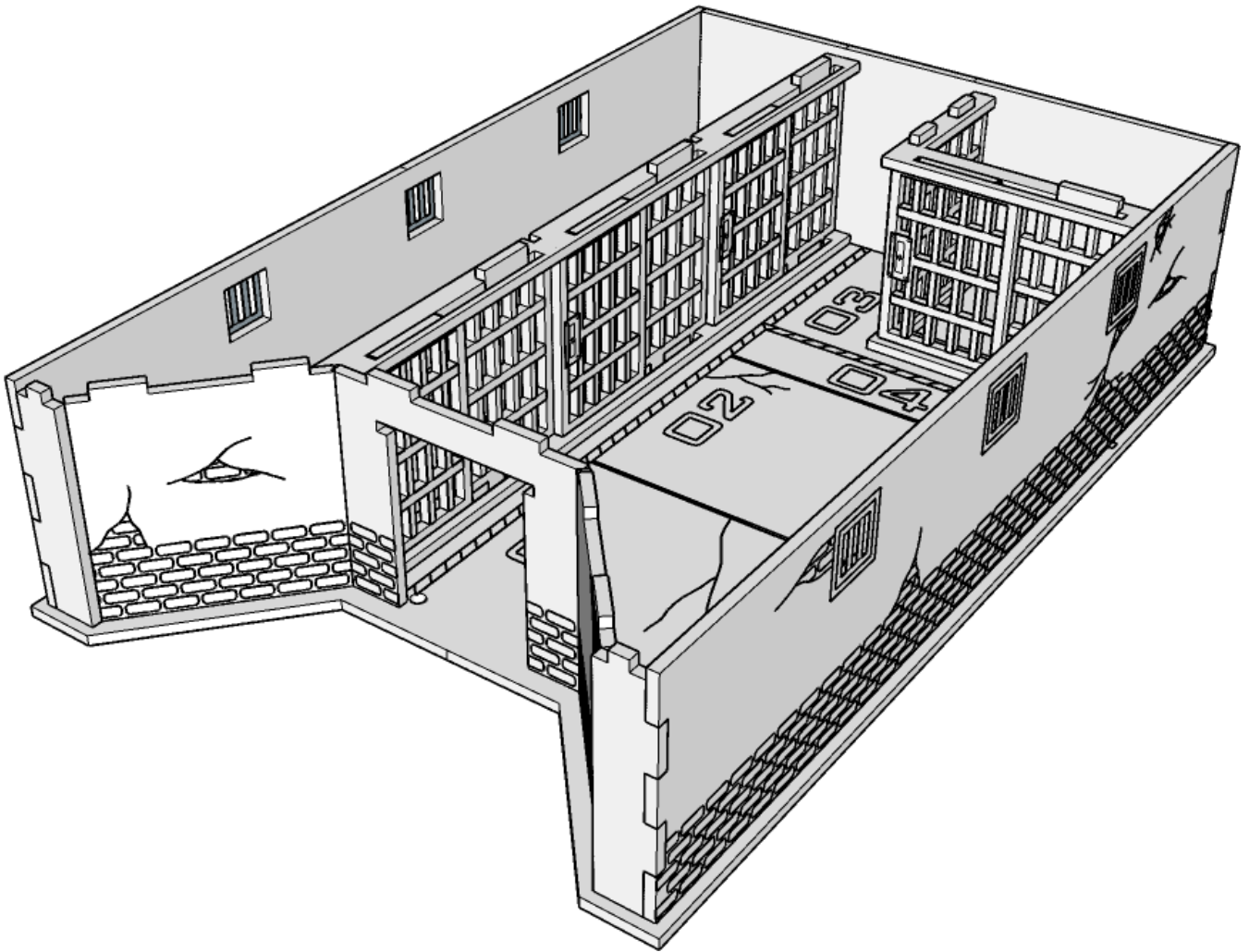

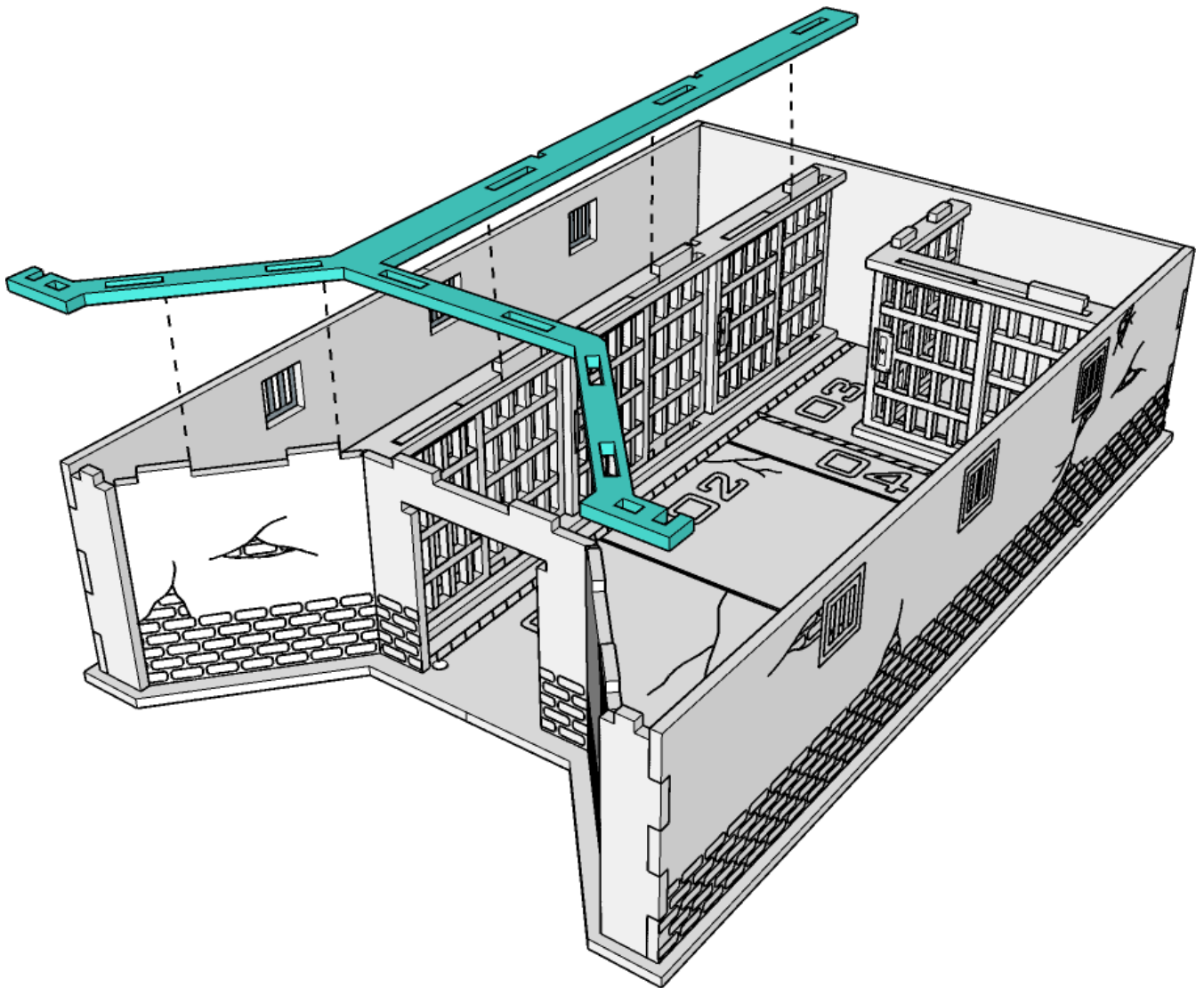

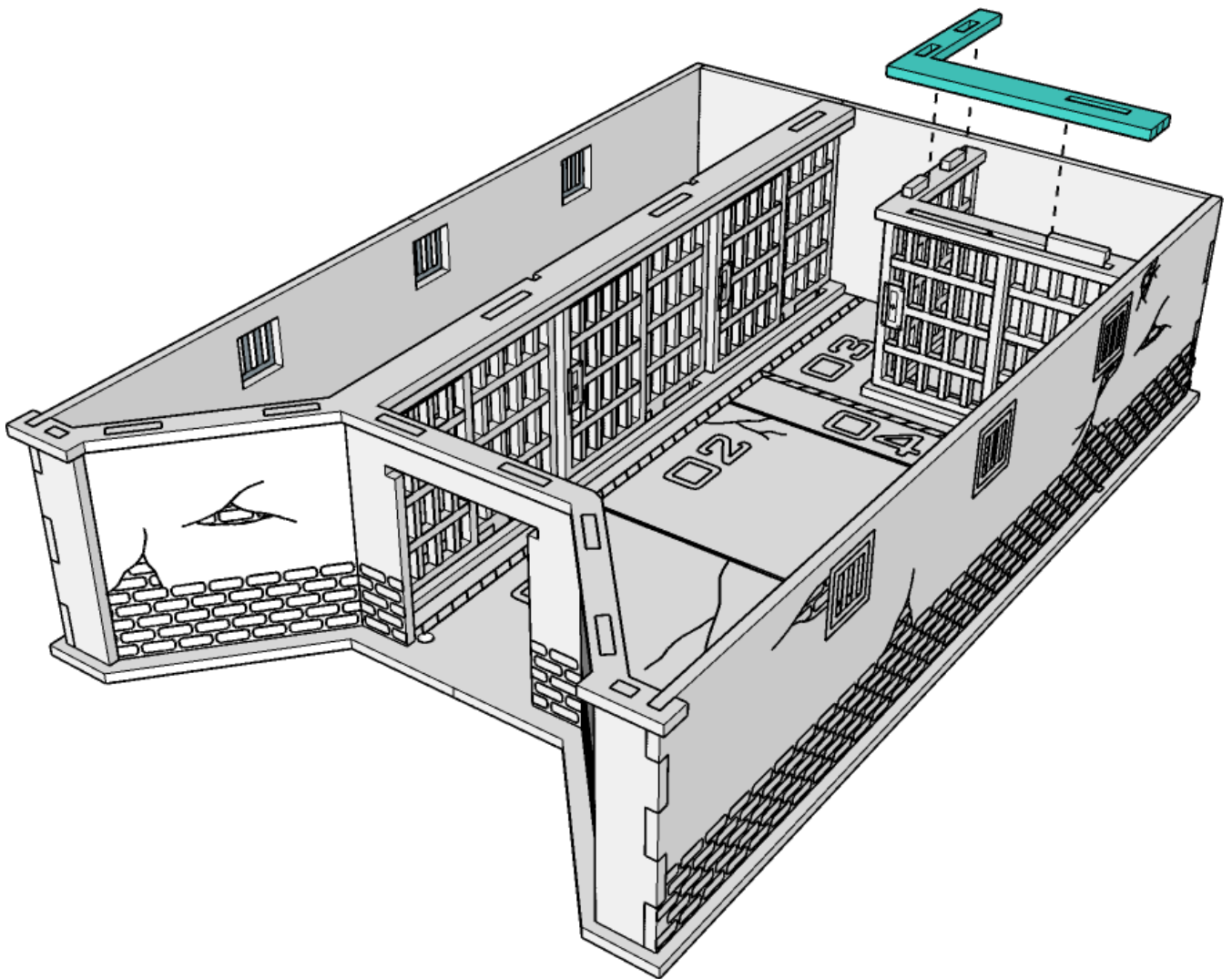

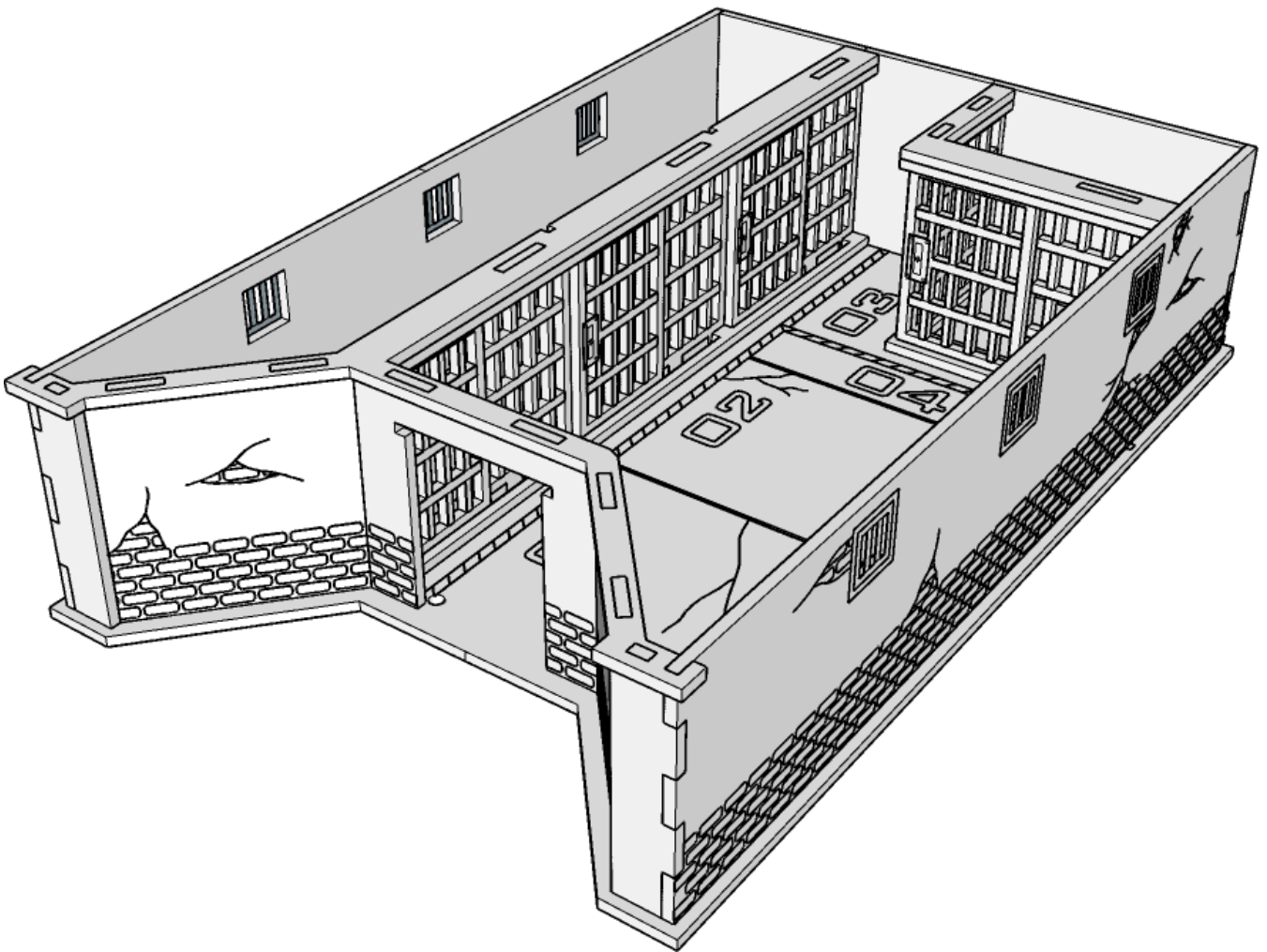

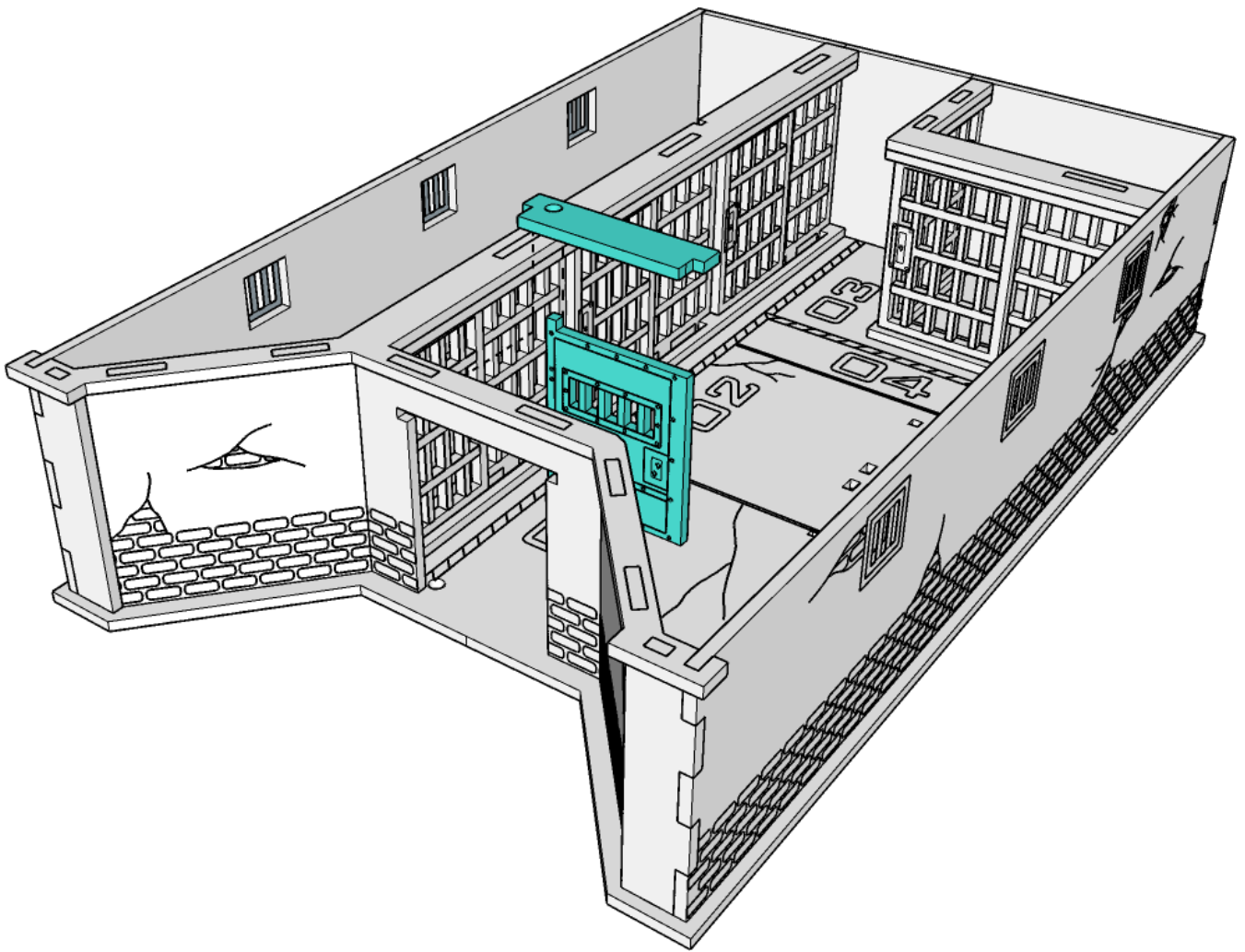

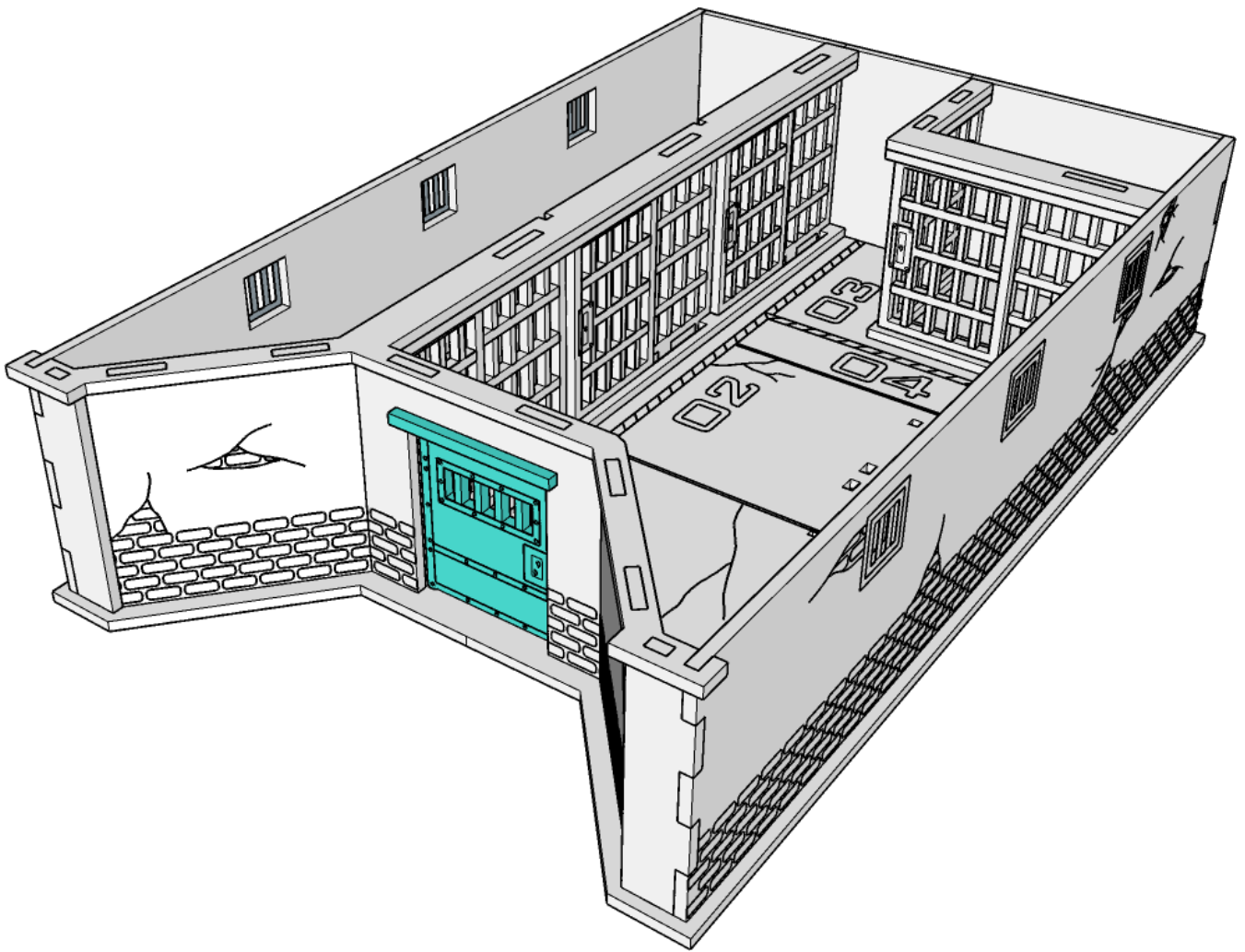



**TABLETOP
SCENICS**

**TTSCW-DCS-158
PCPD: Cell Block**

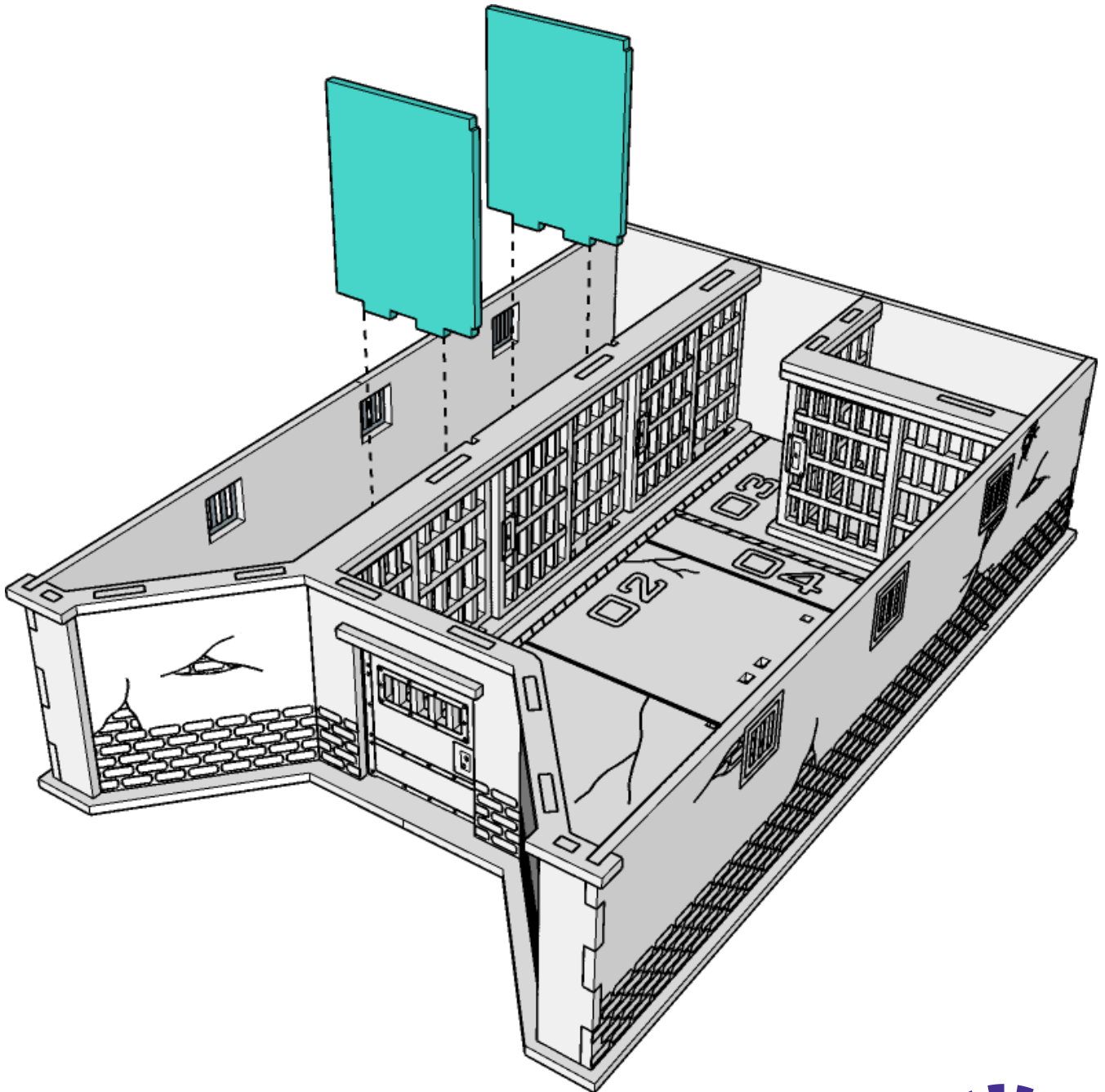

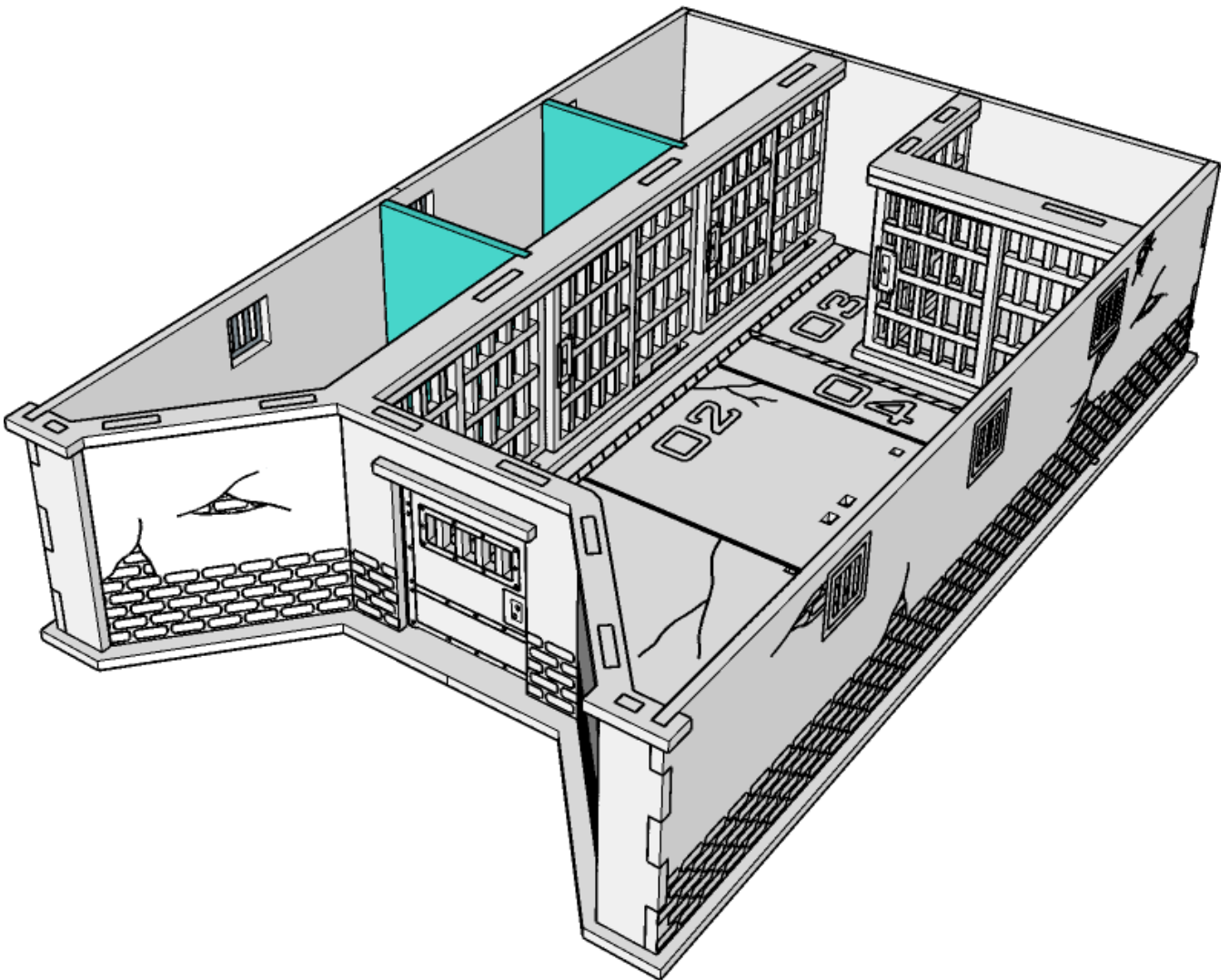

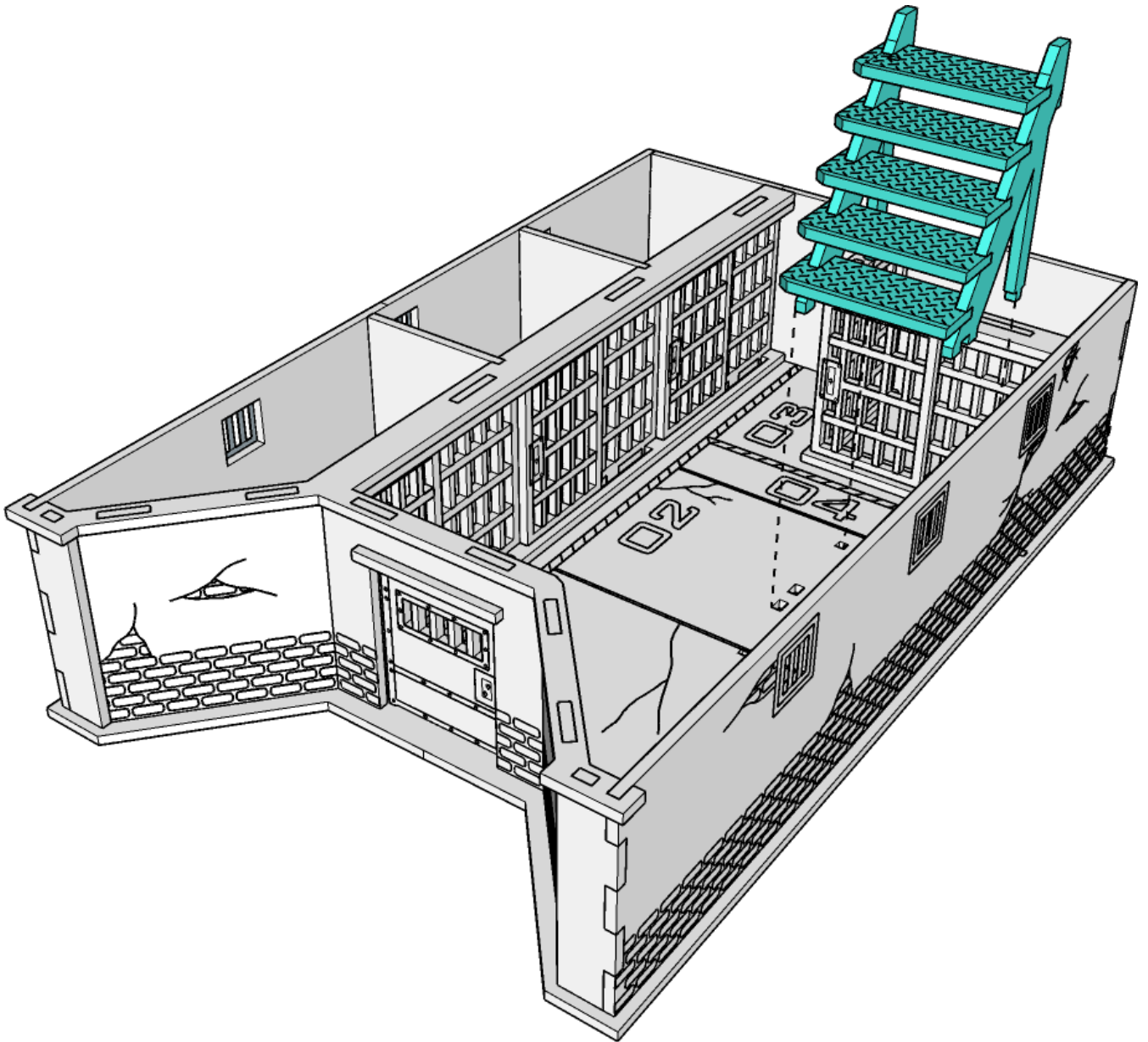

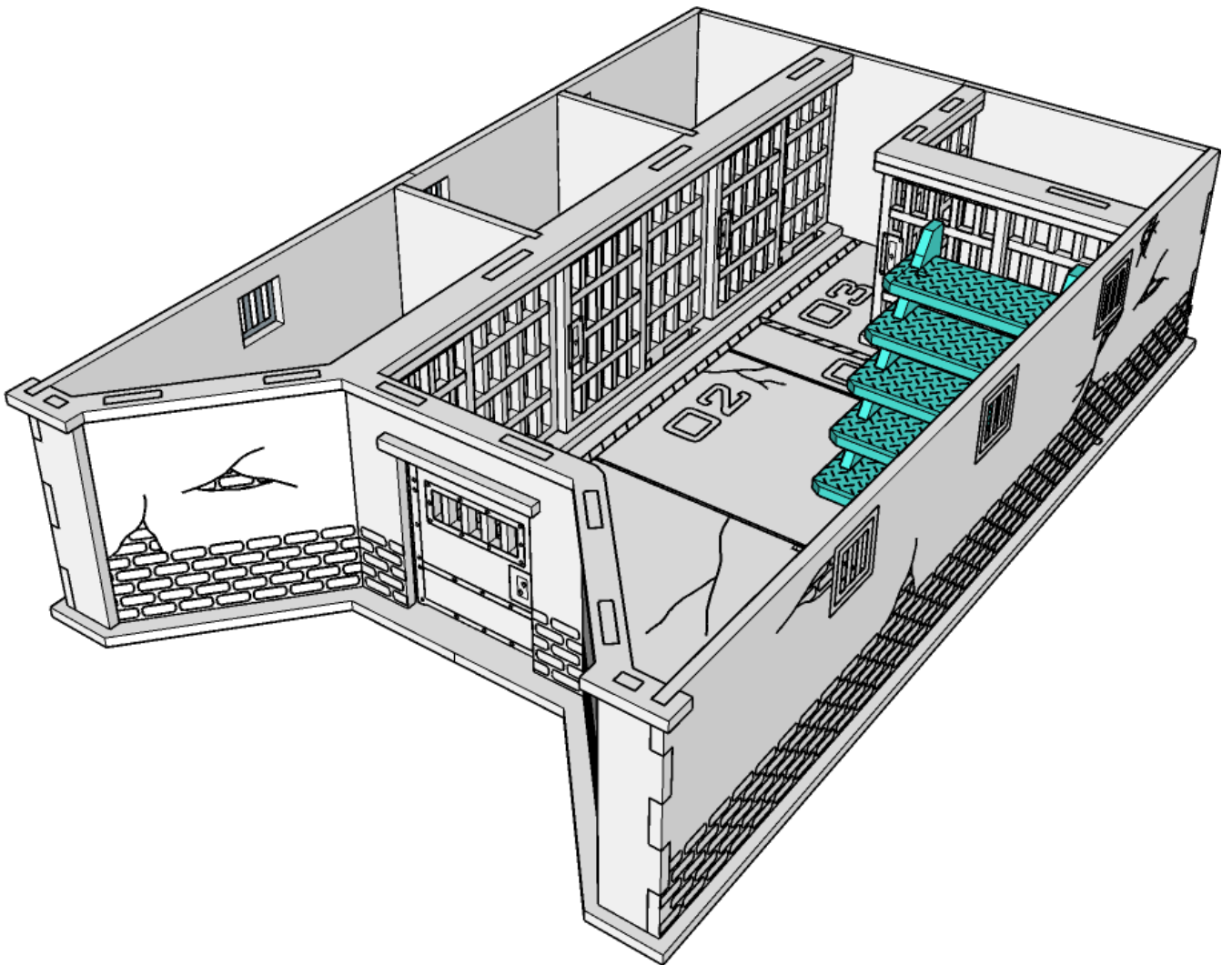

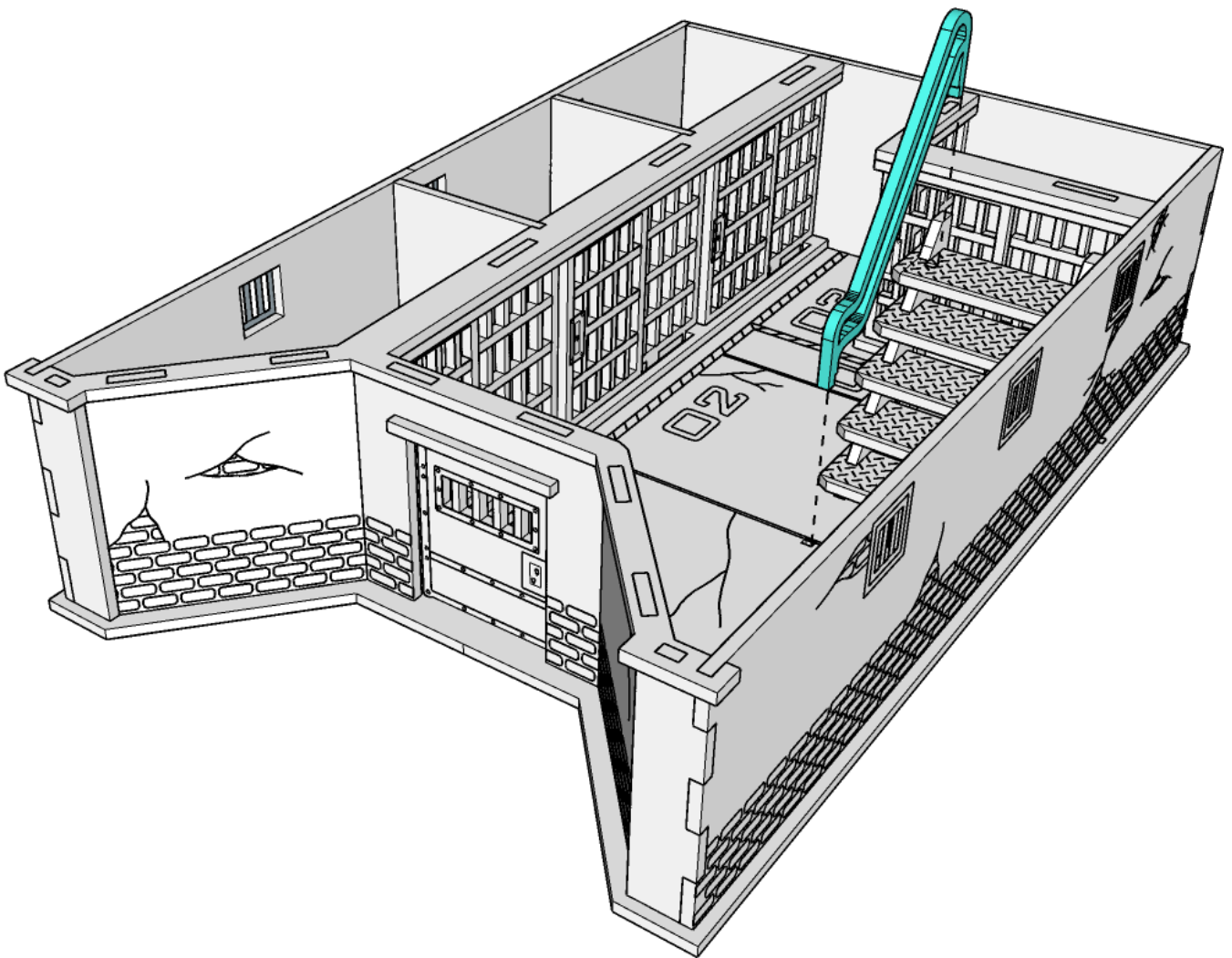

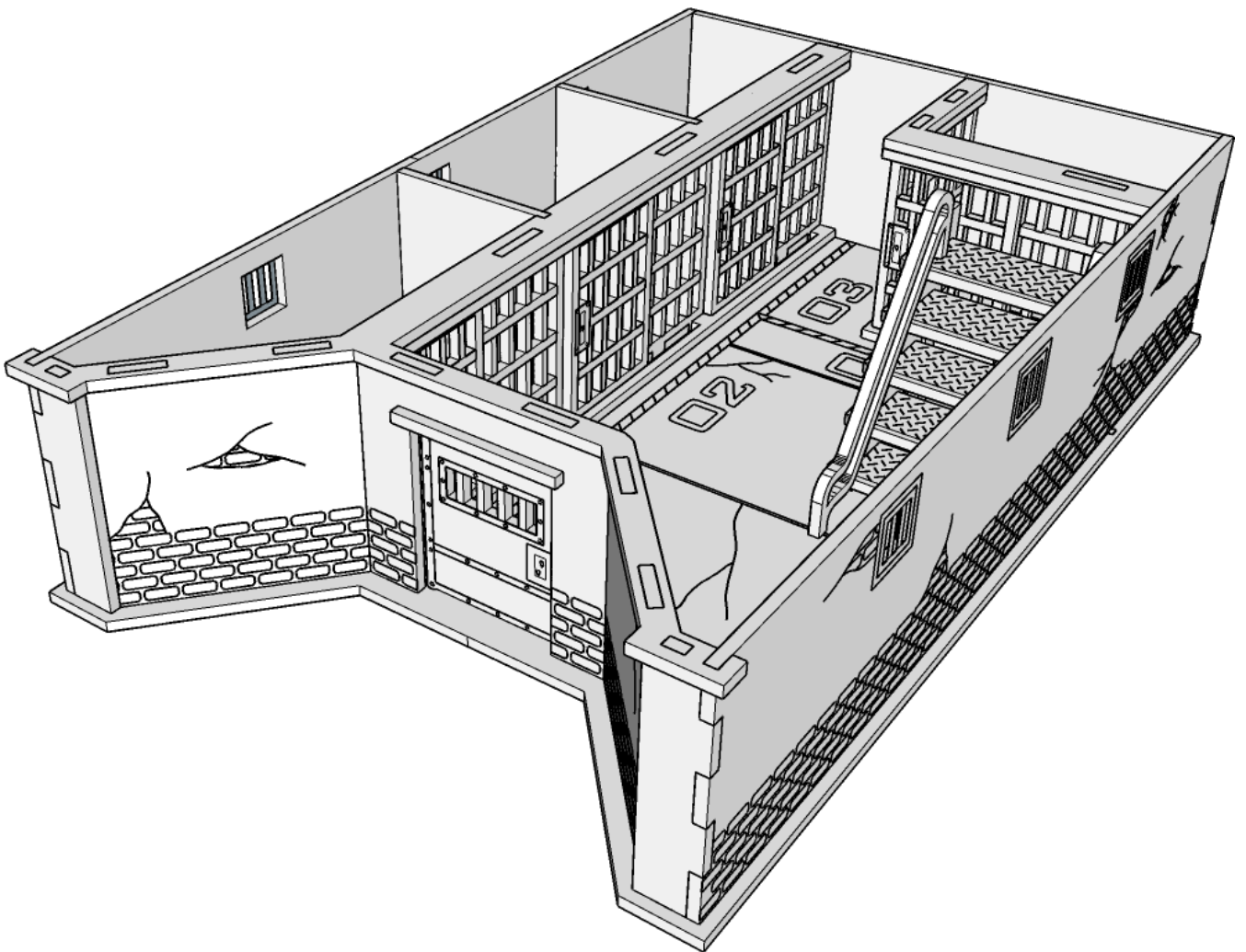

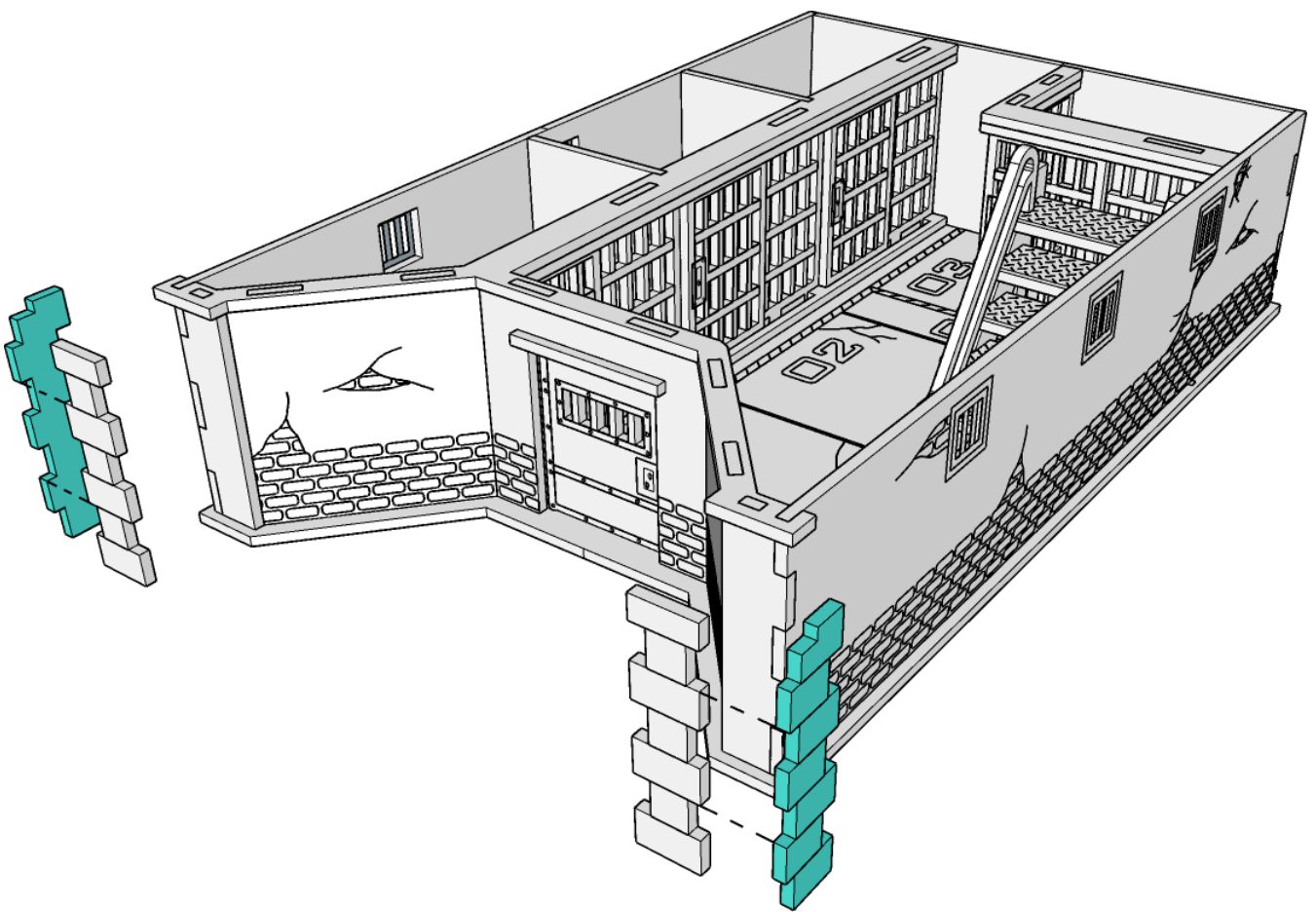

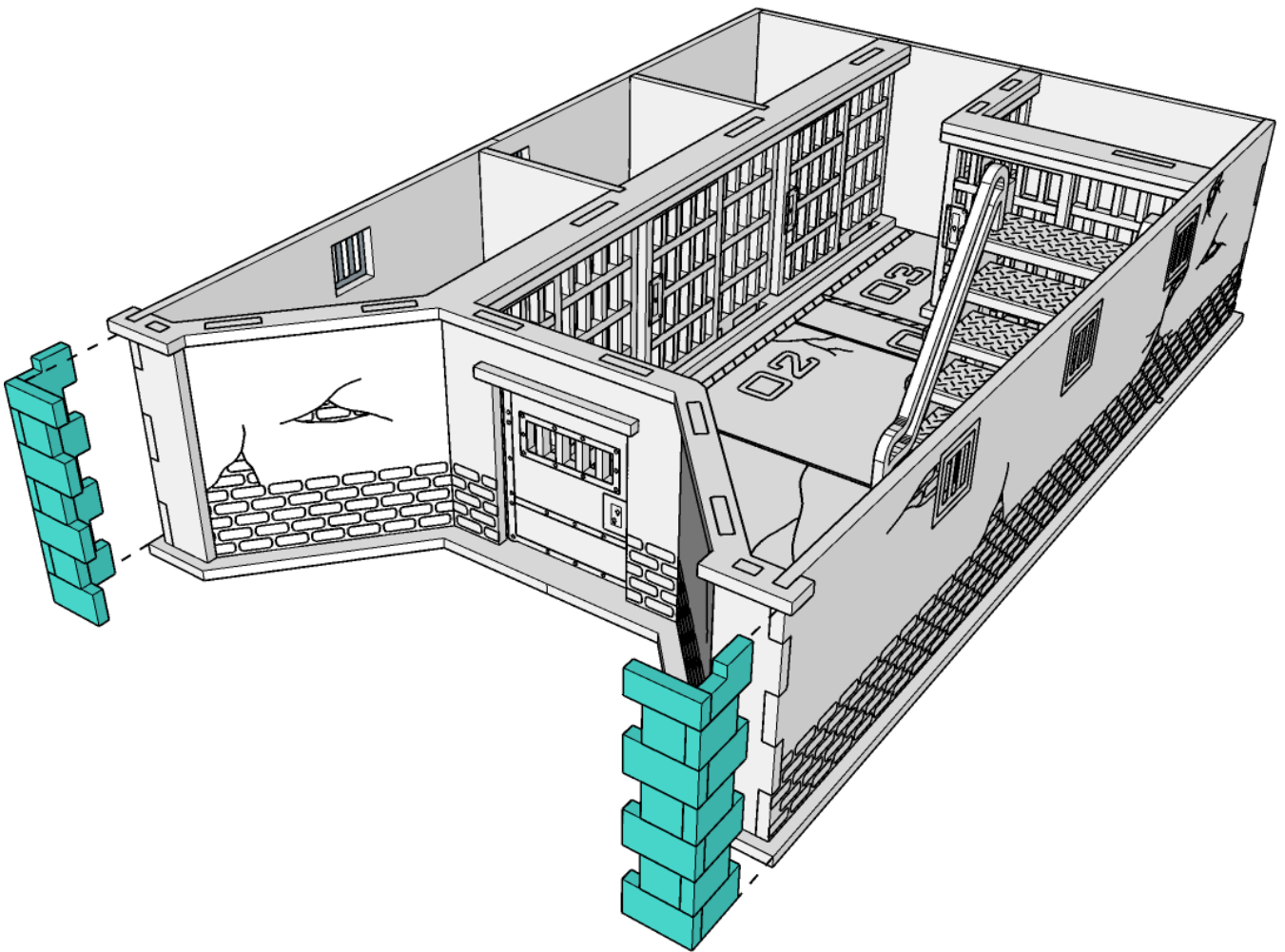

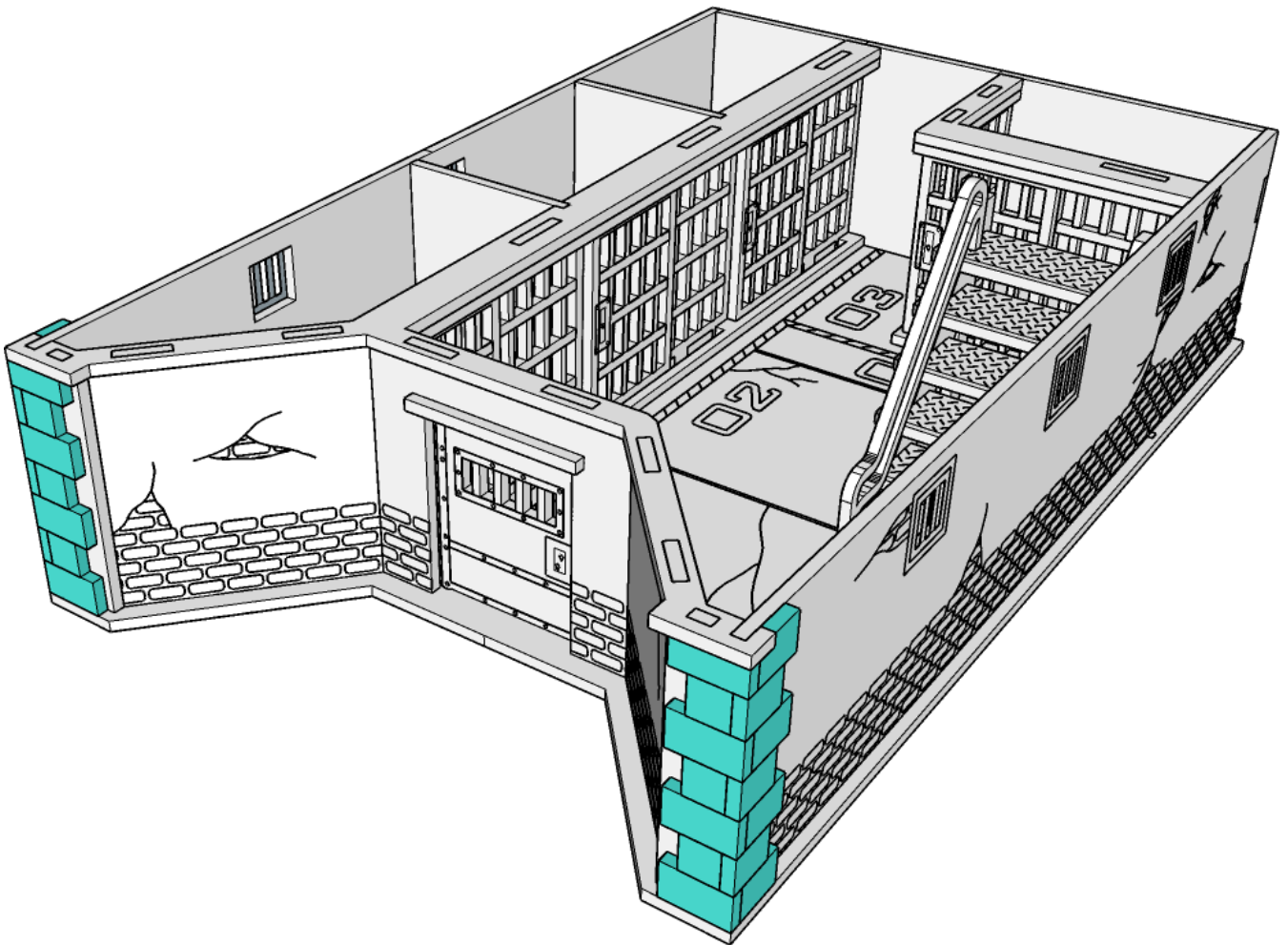

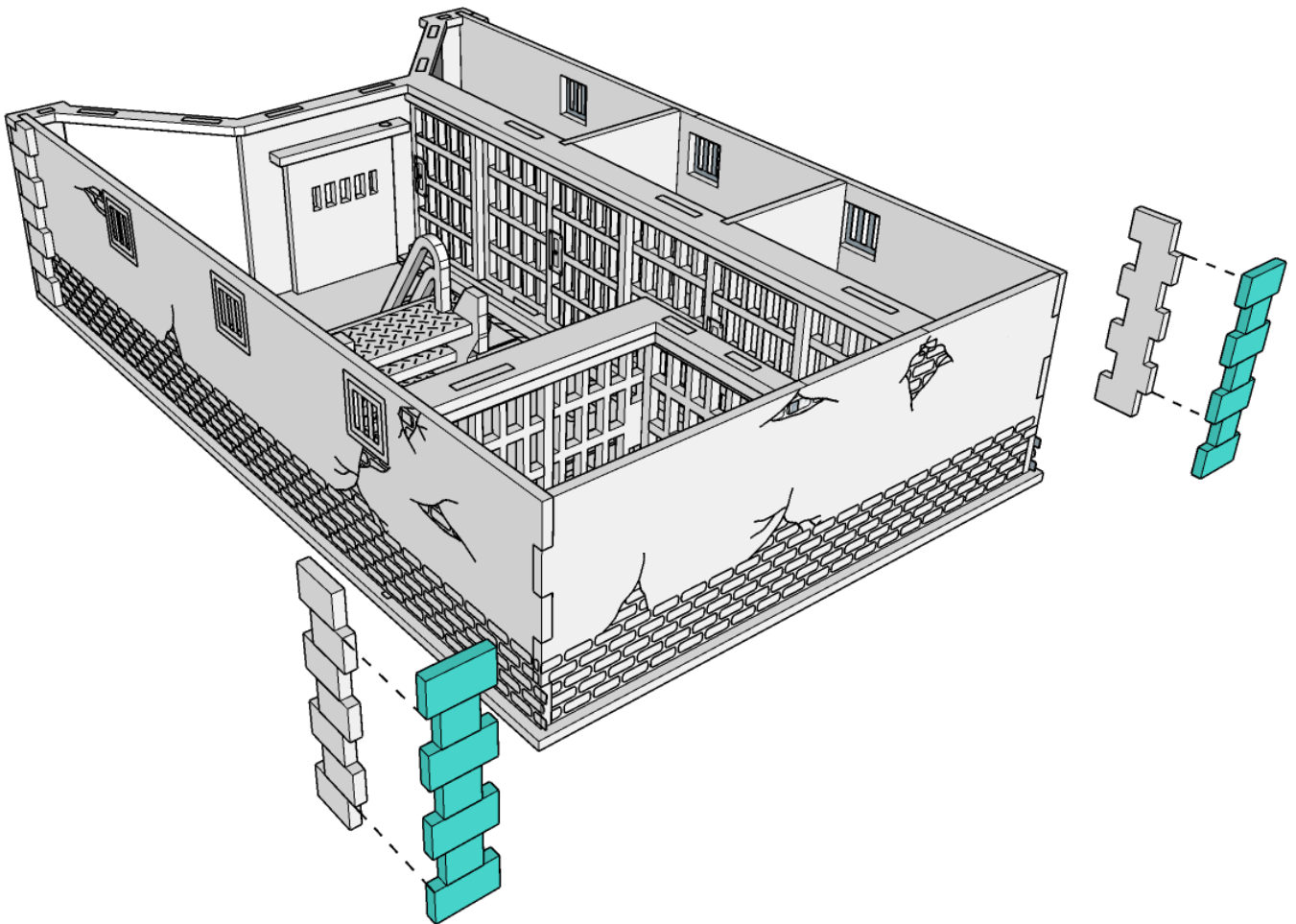



TABLETOP SCENICS

TTSCW-DCS-158
PCPD: Cell Block

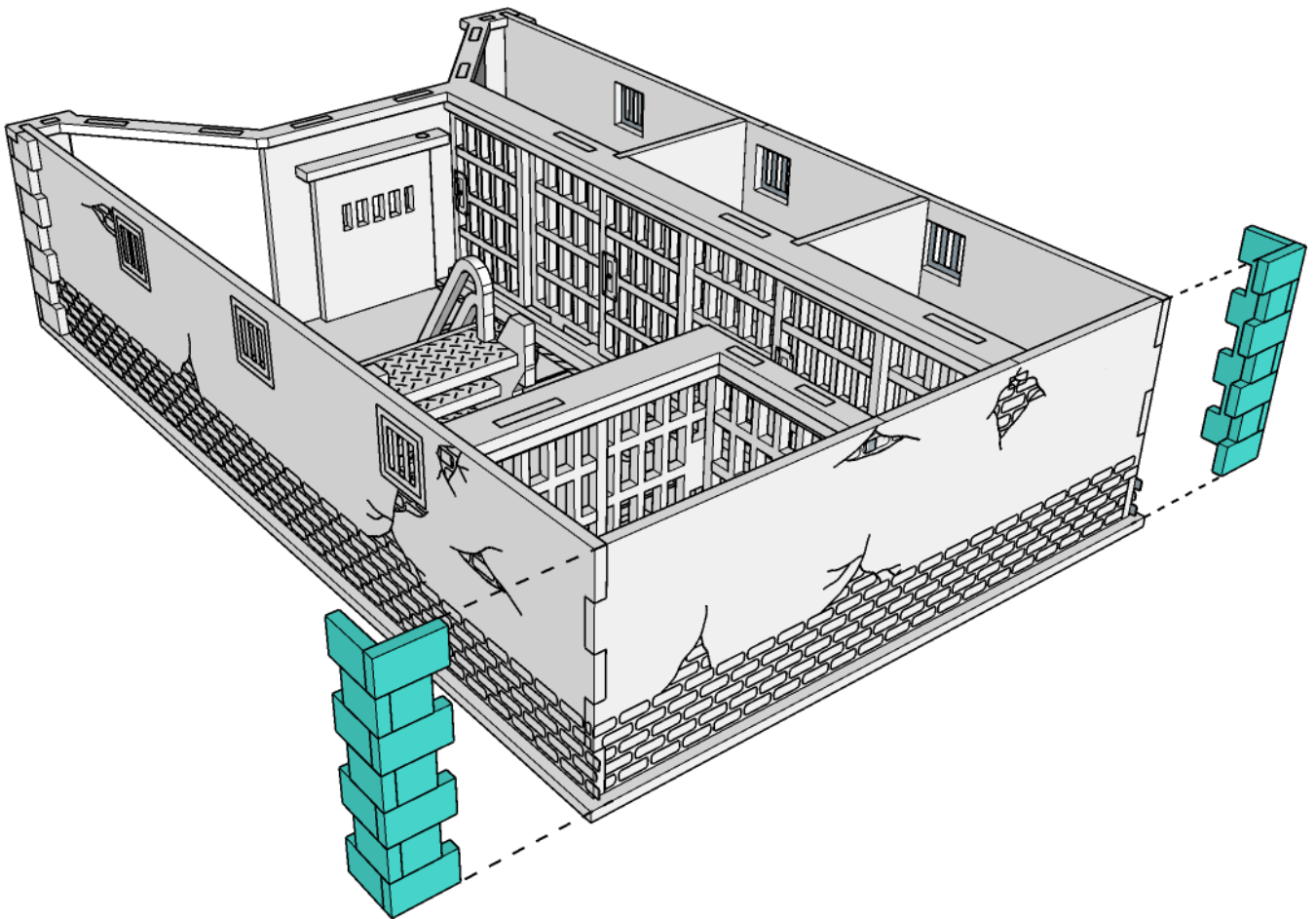



**TABLETOP
SCENICS**

**TTSCW-DCS-158
PCPD: Cell Block**

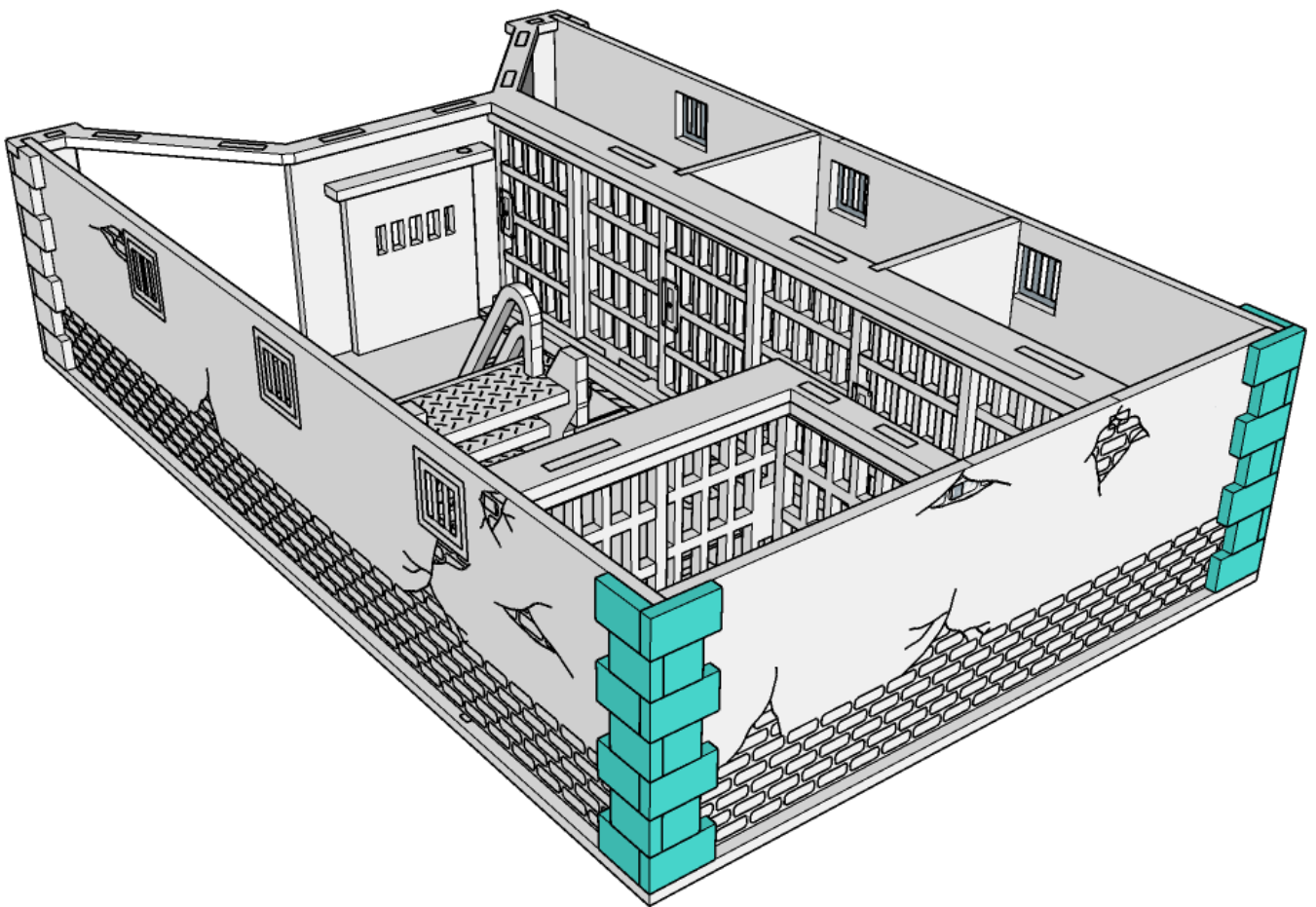

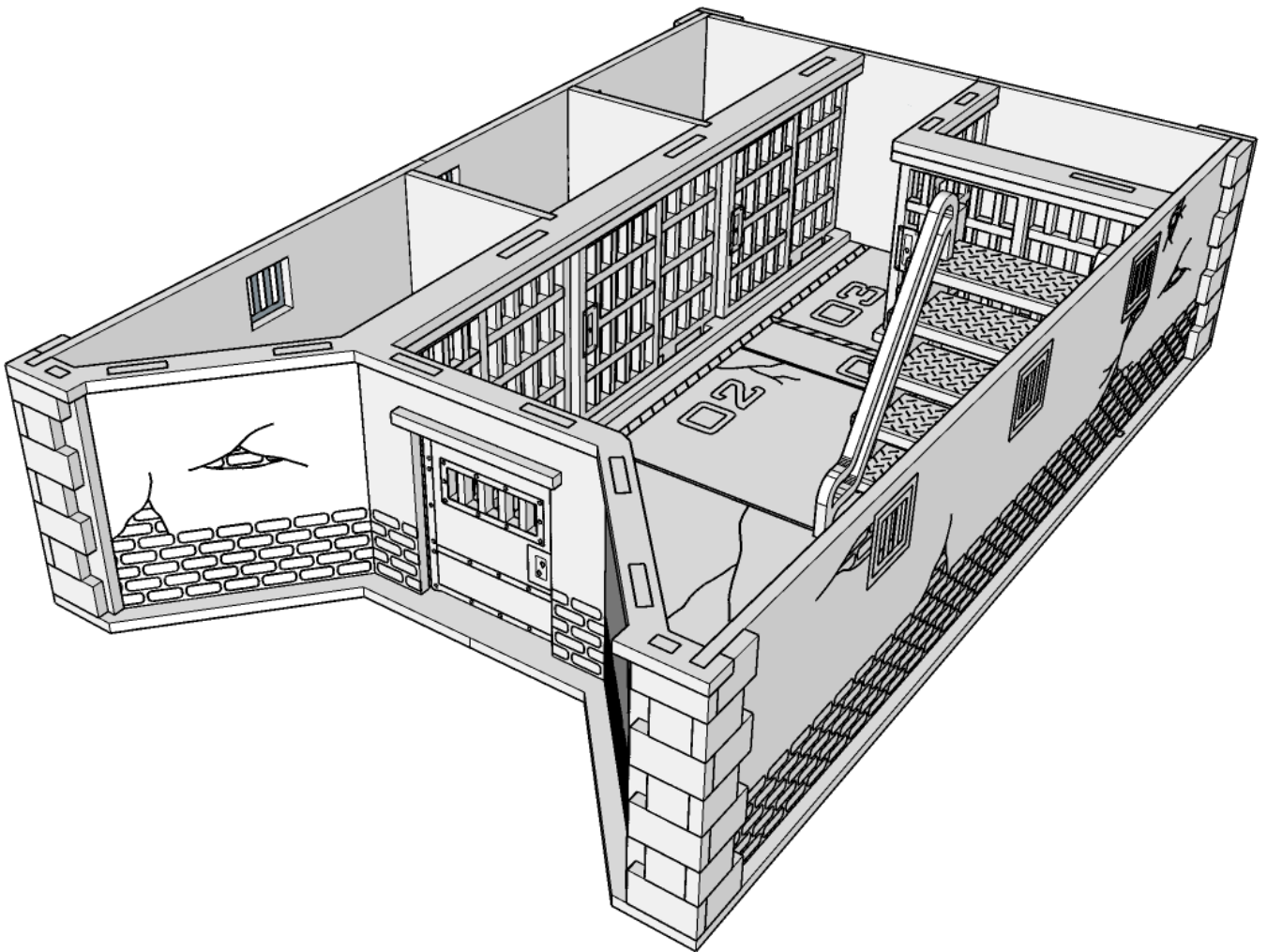

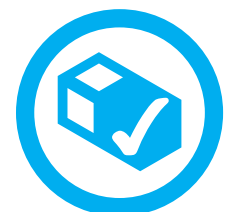
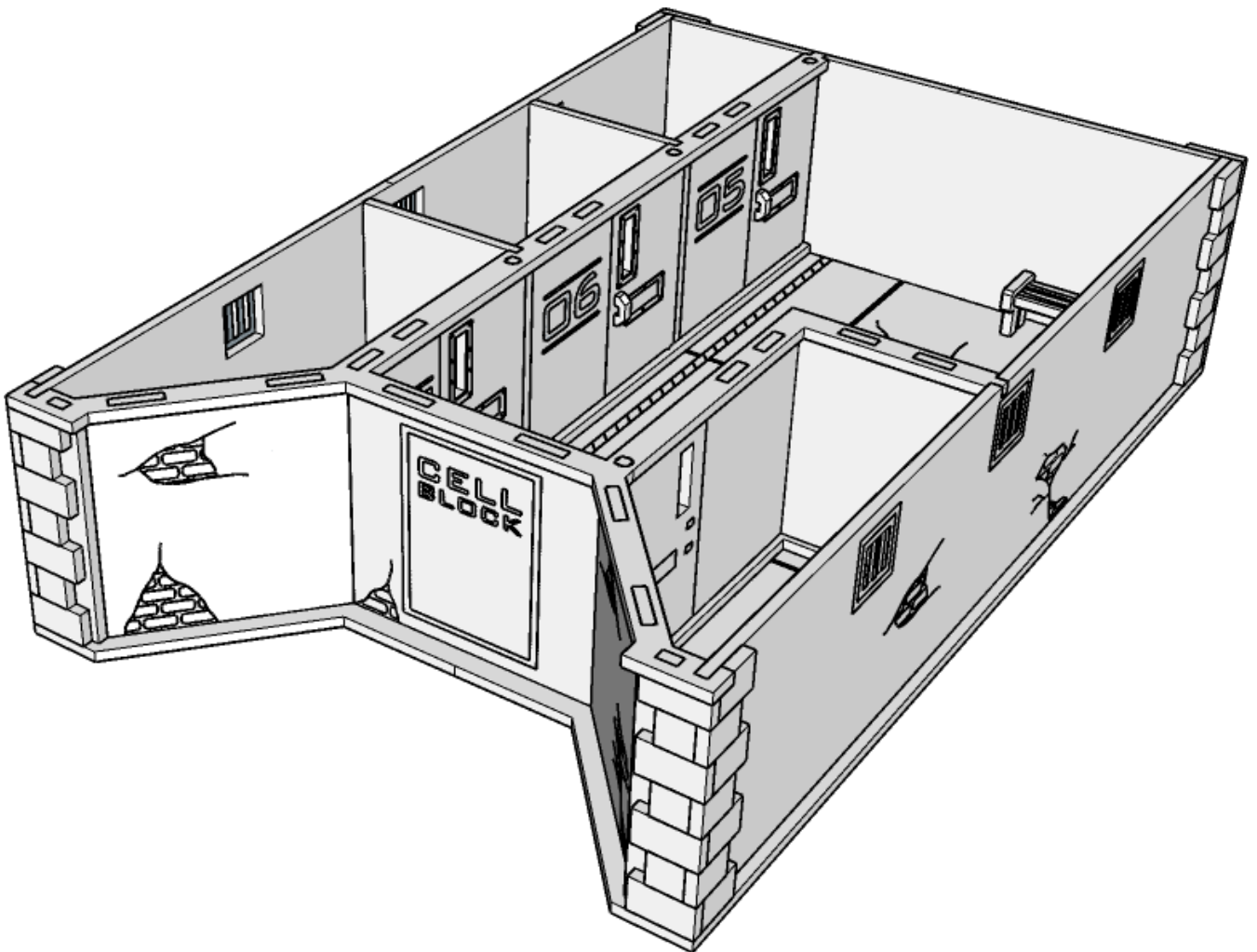



TABLETOP
SCENICS

TTSCW-DCS-158
PCPD: Cell Block

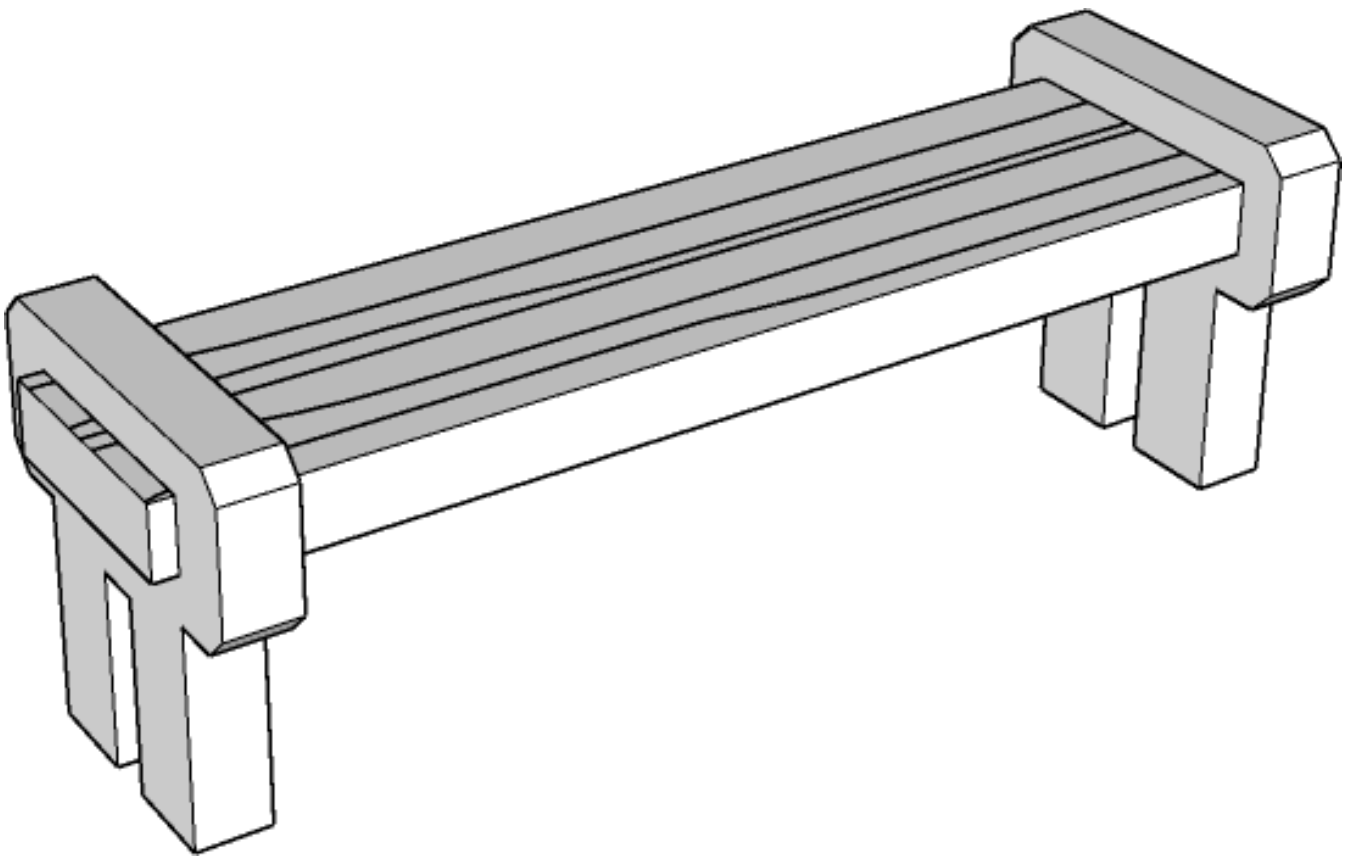

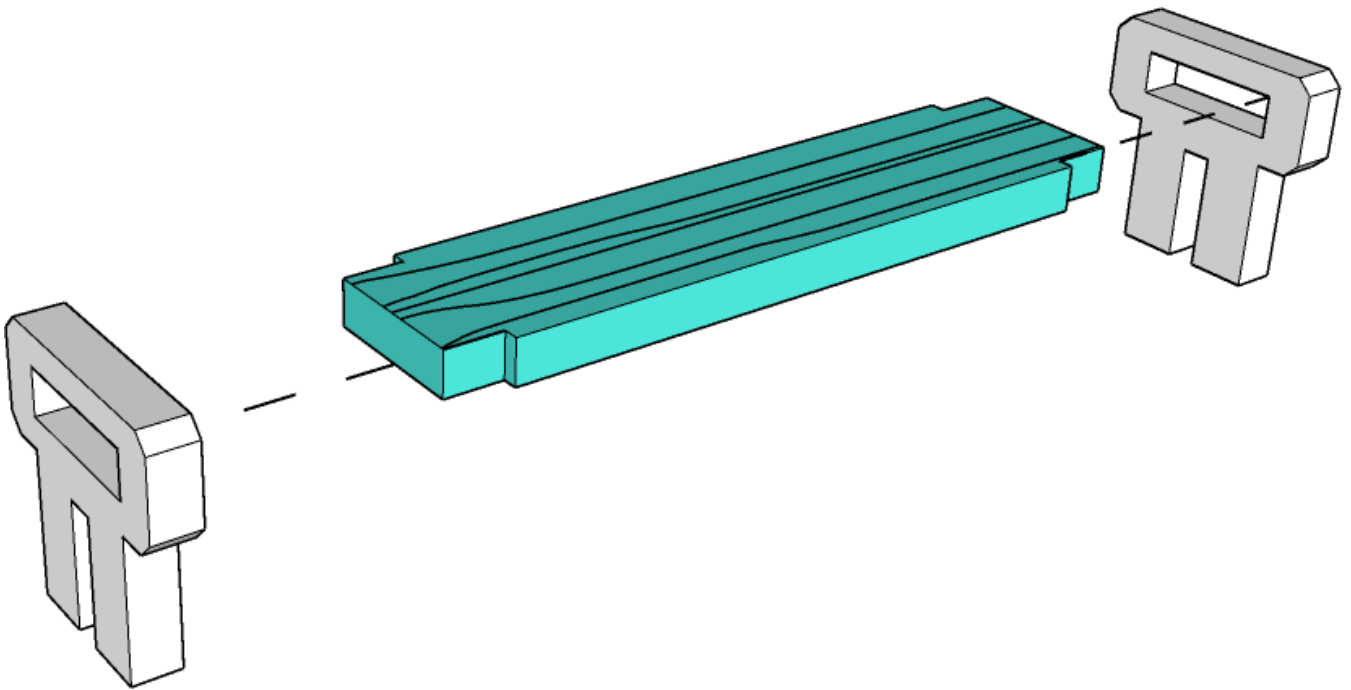



TABLETOP
SCENICS

TTSCW-DCS-158
PCPD: Cell Block

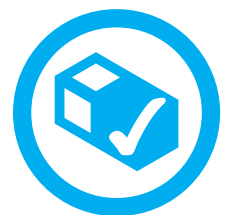
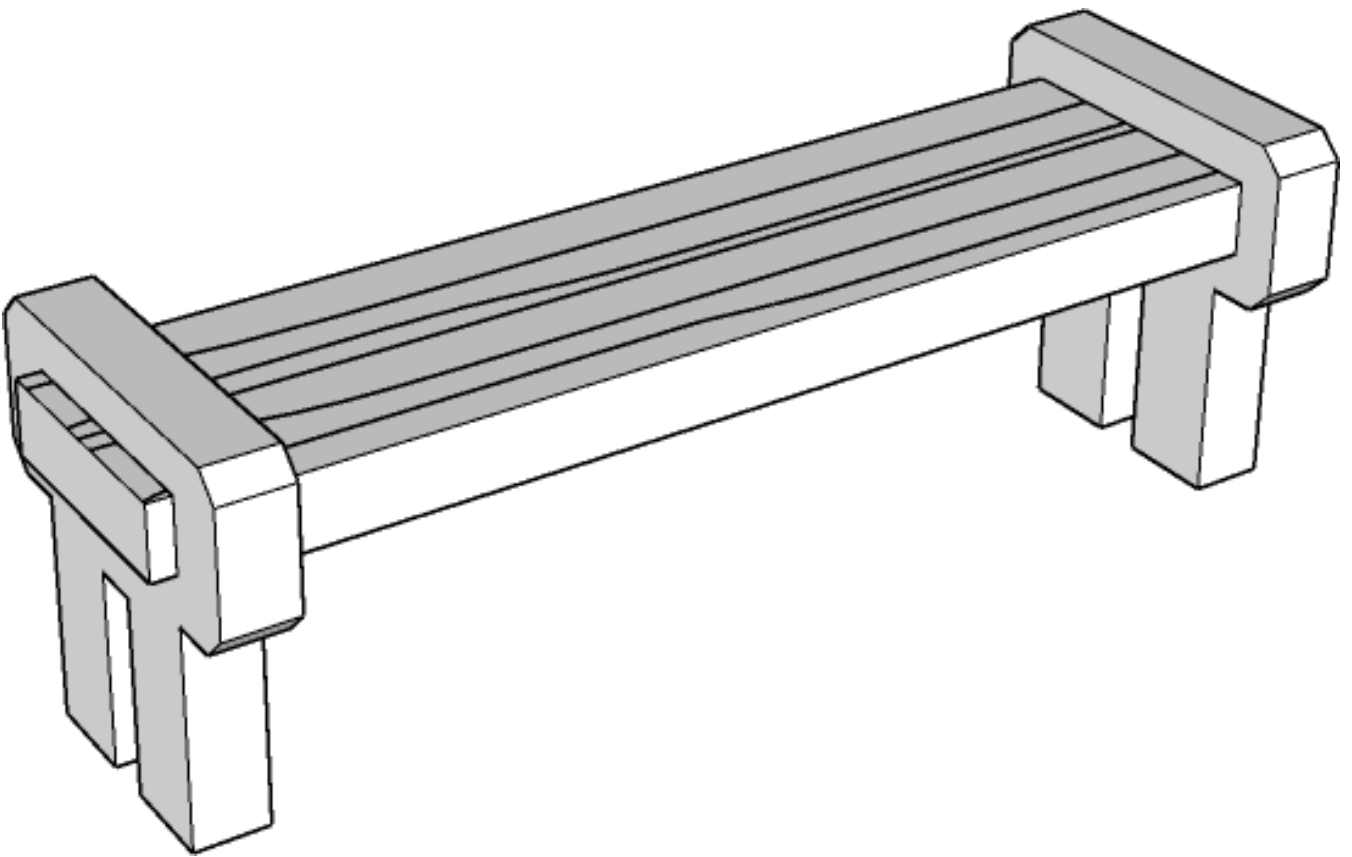

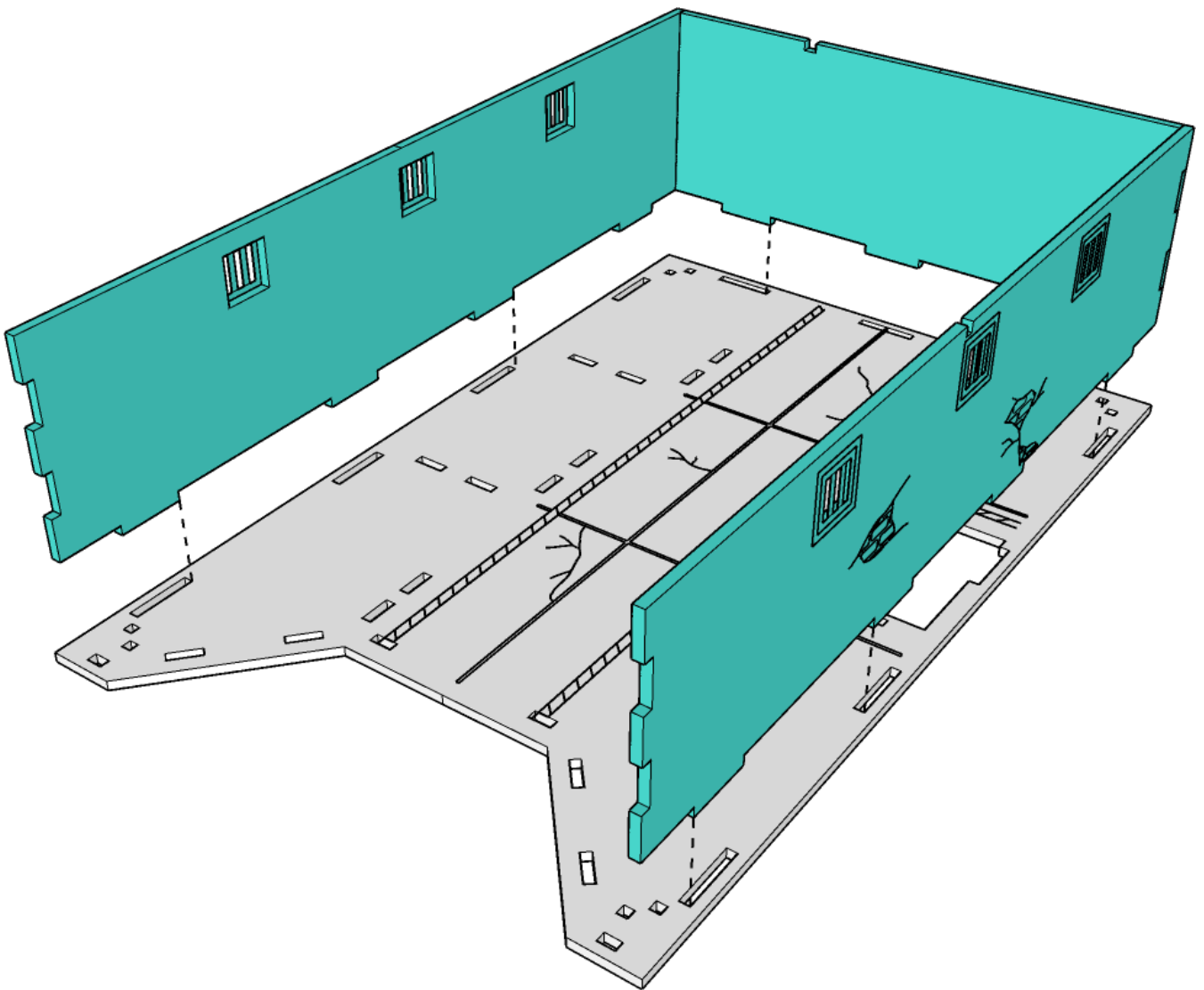

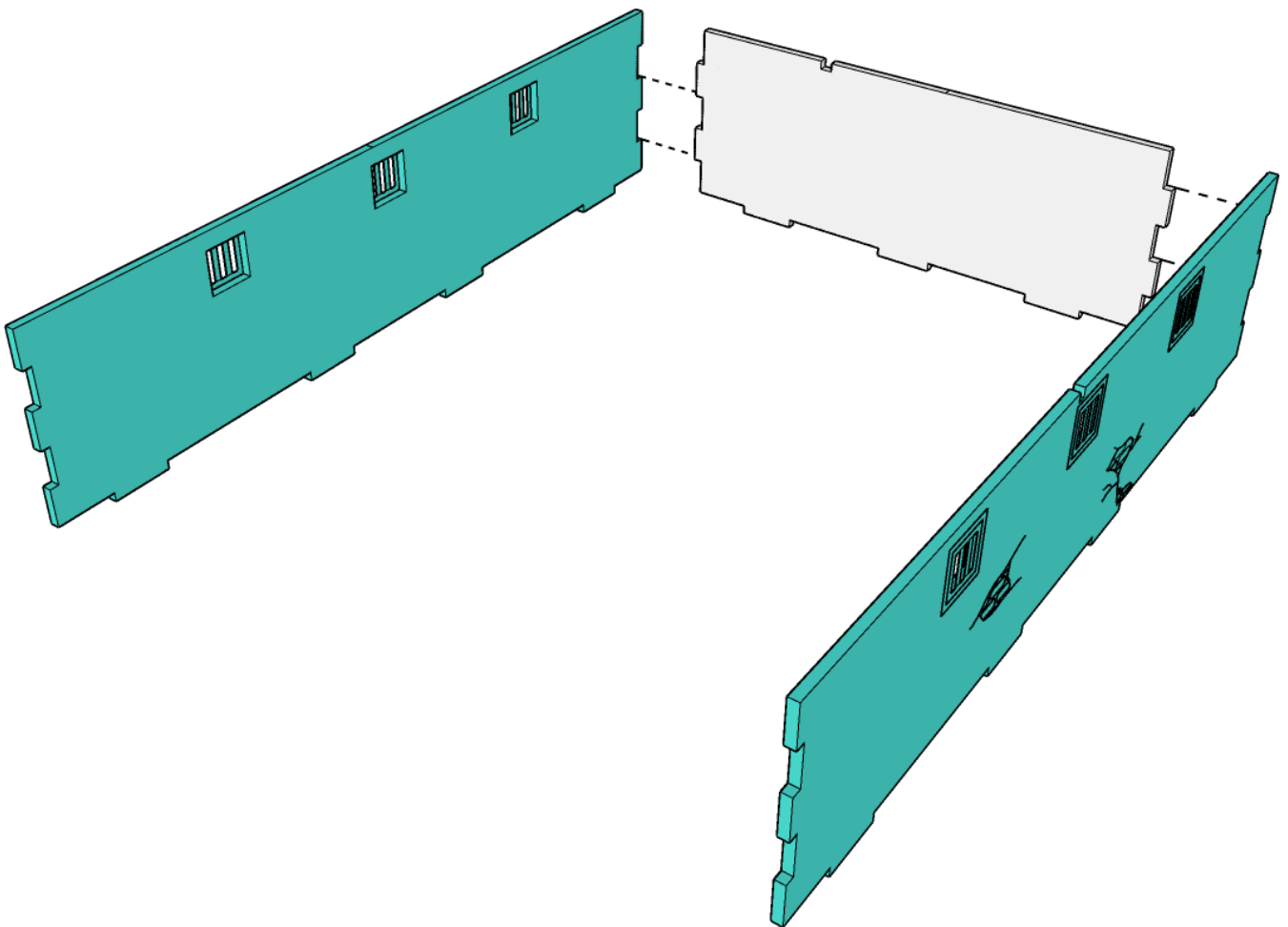

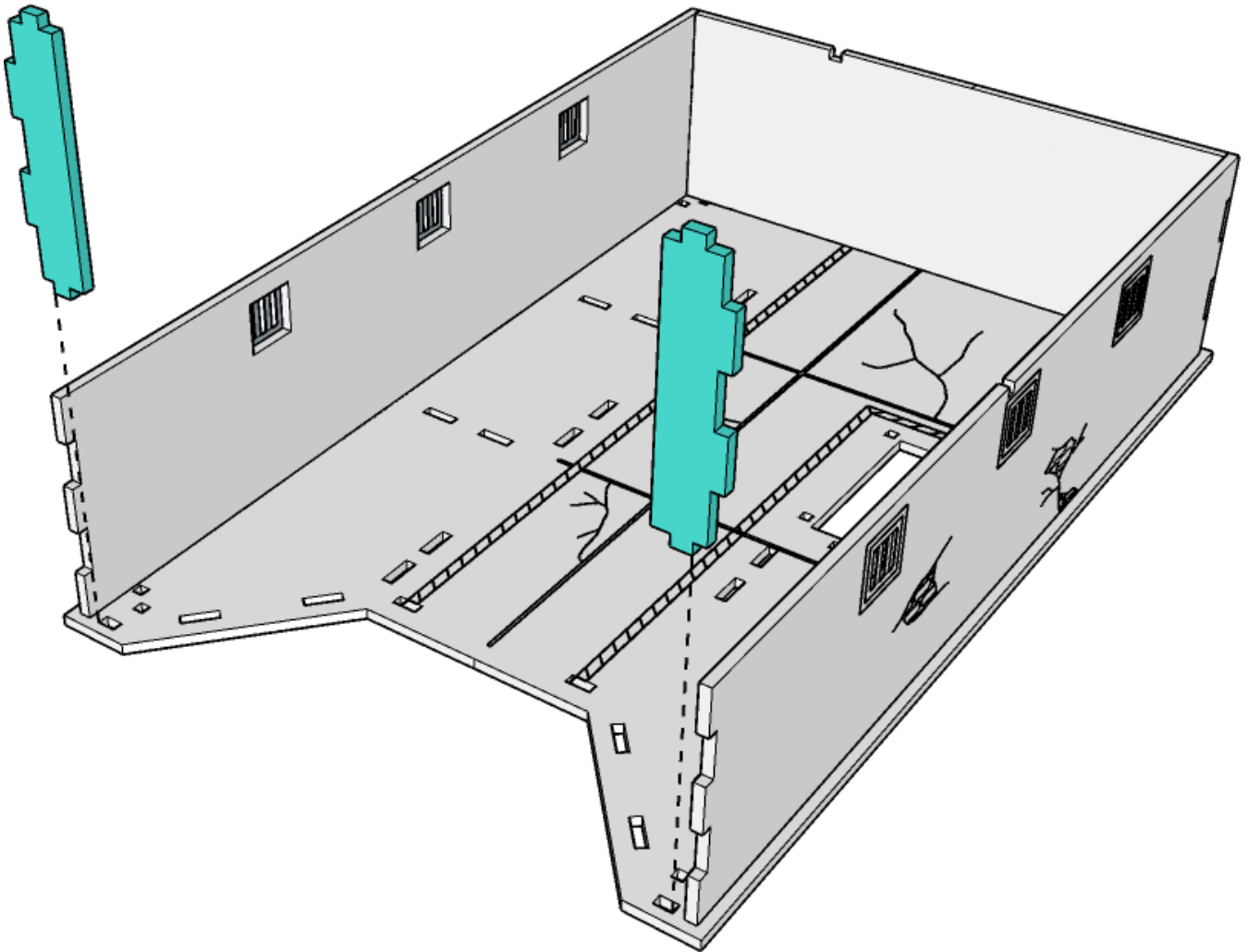



TABLETOP
SCENICS

TTSCW-DCS-158
PCPD: Cell Block

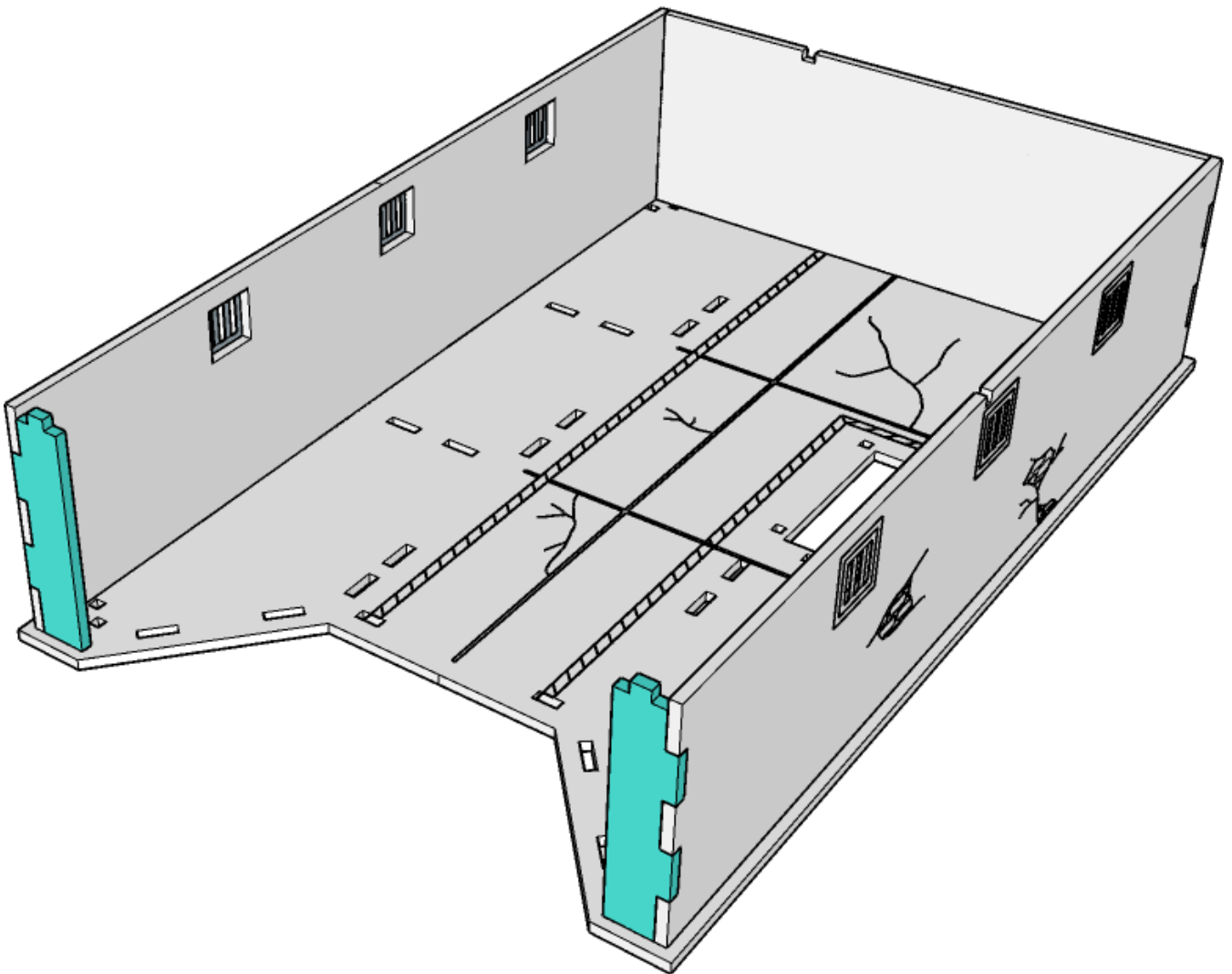

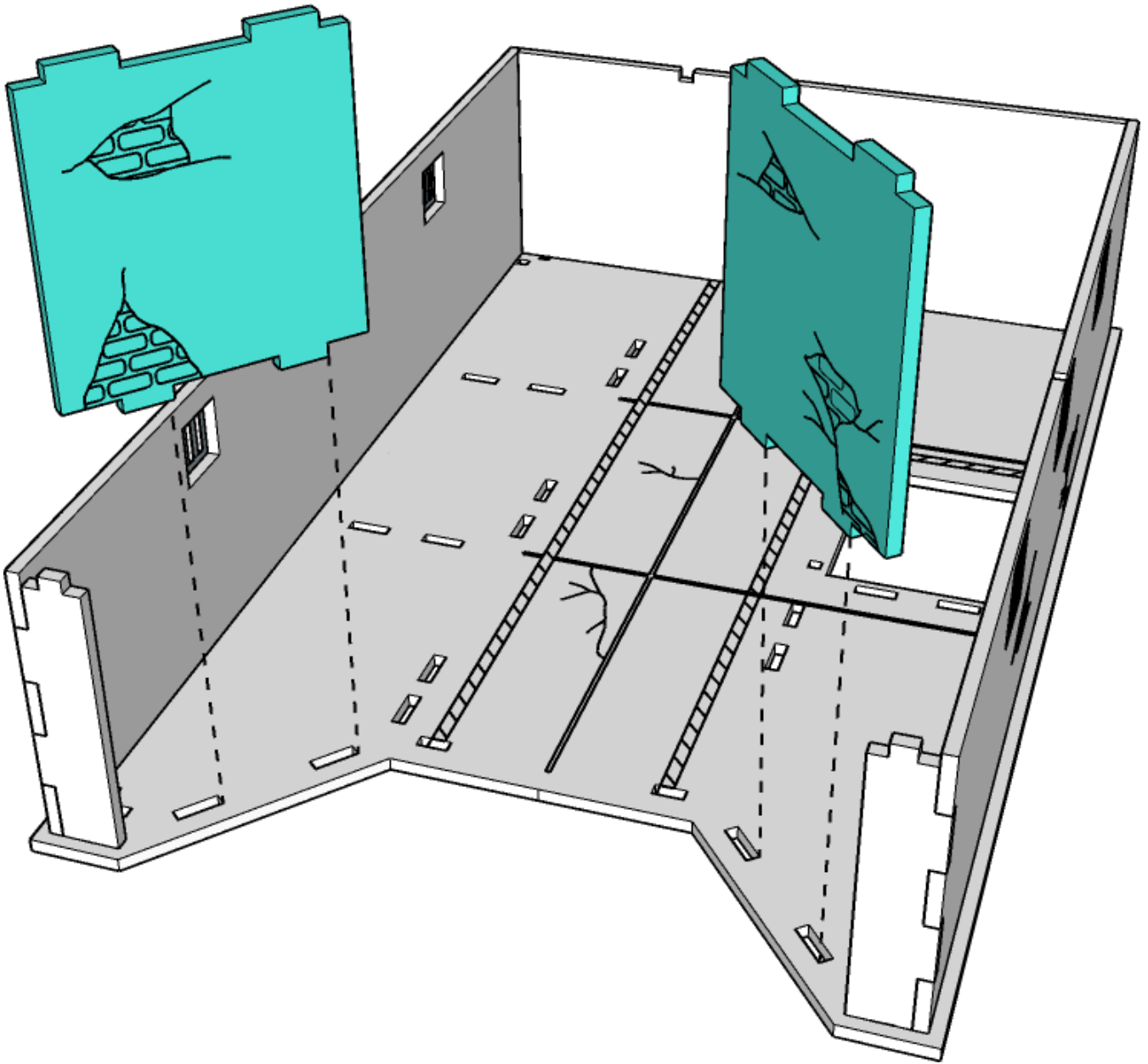

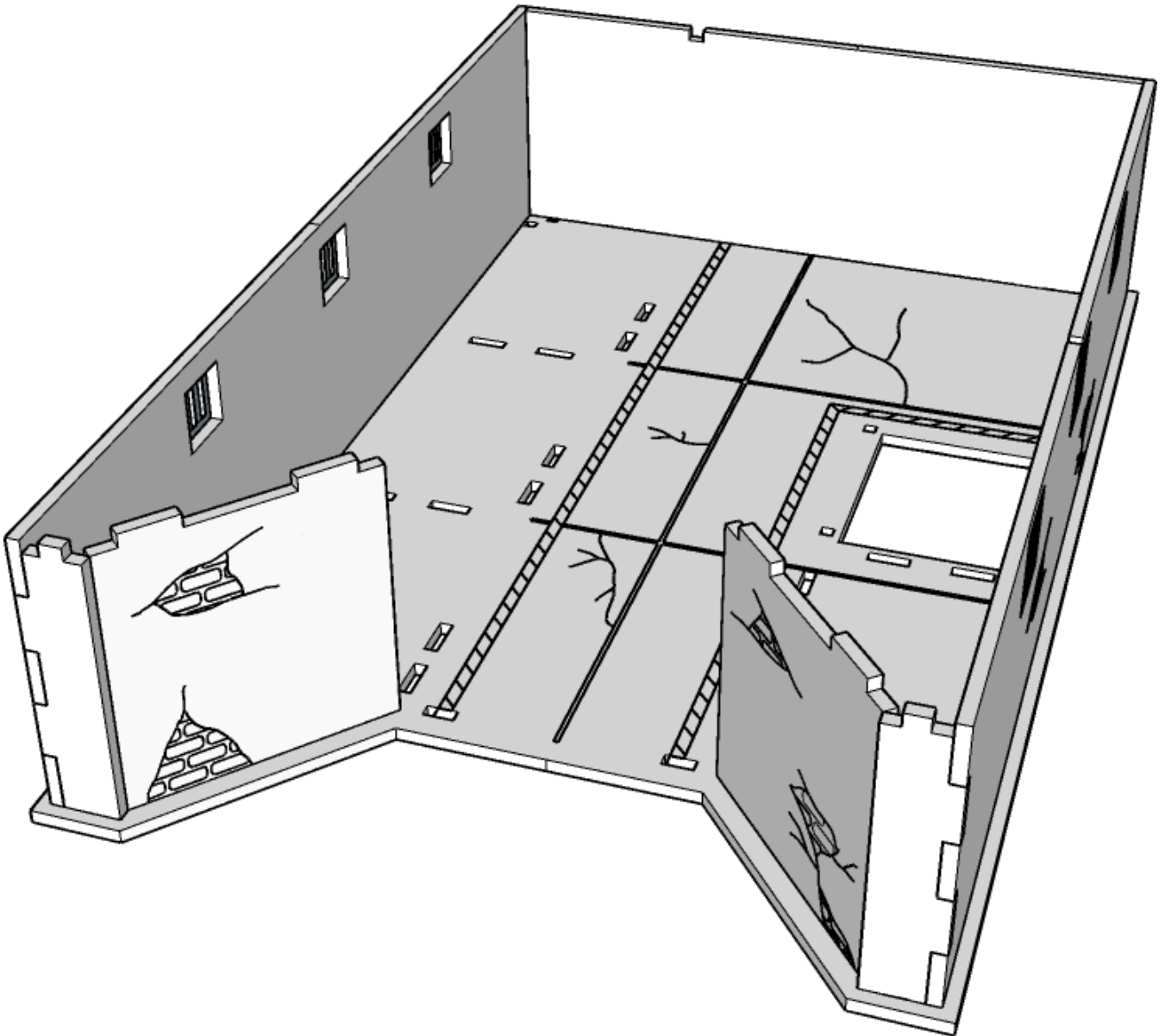

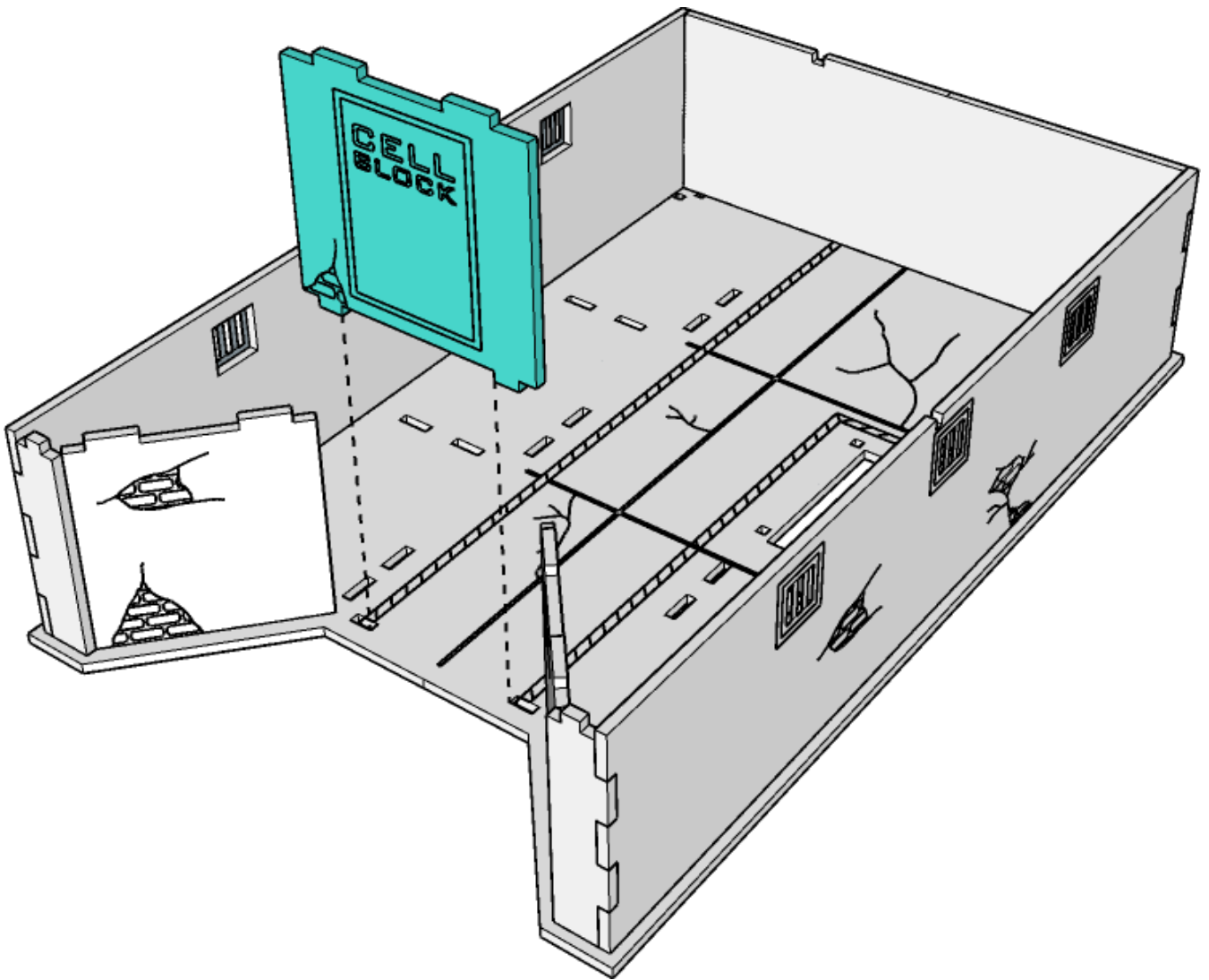

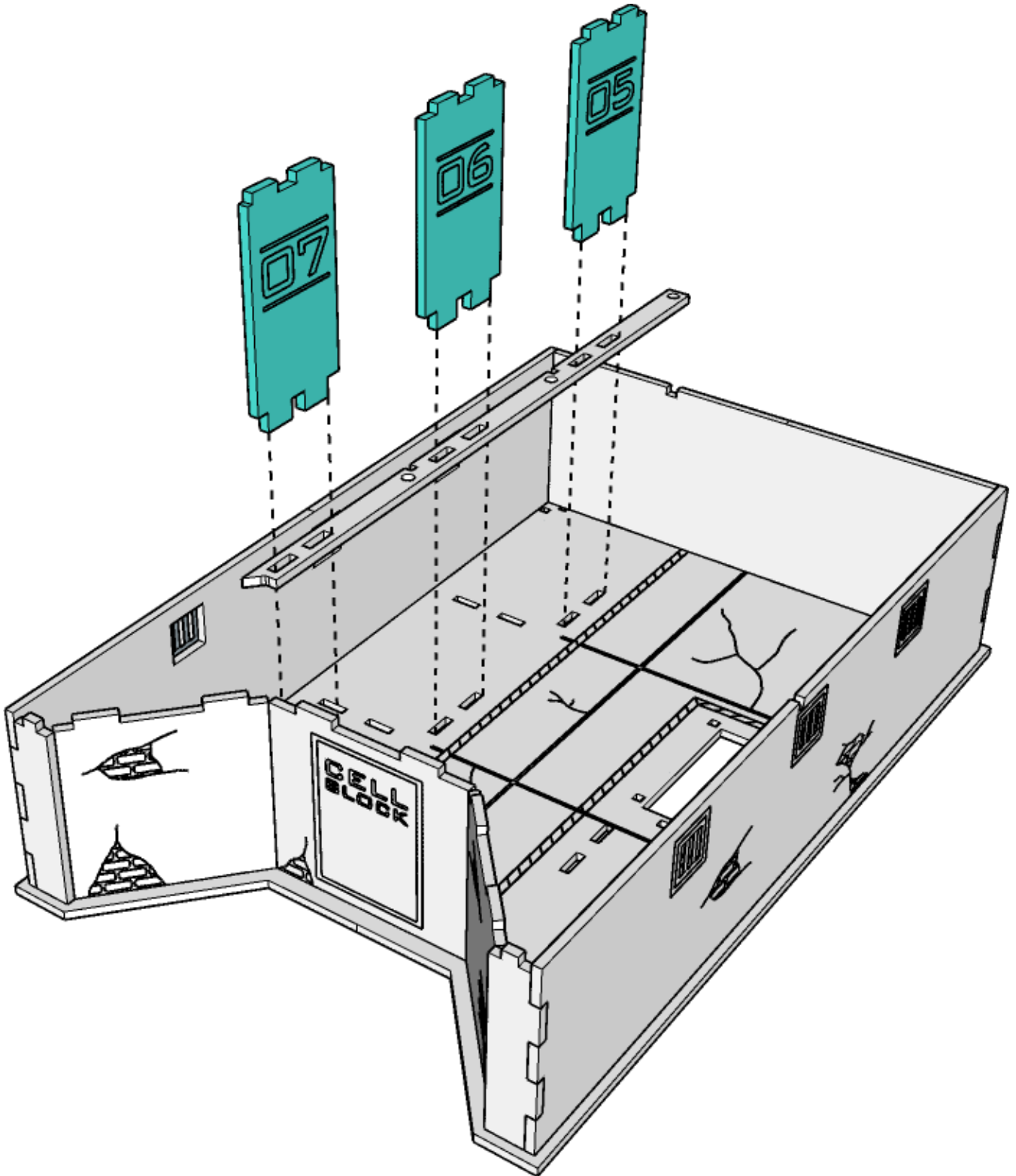

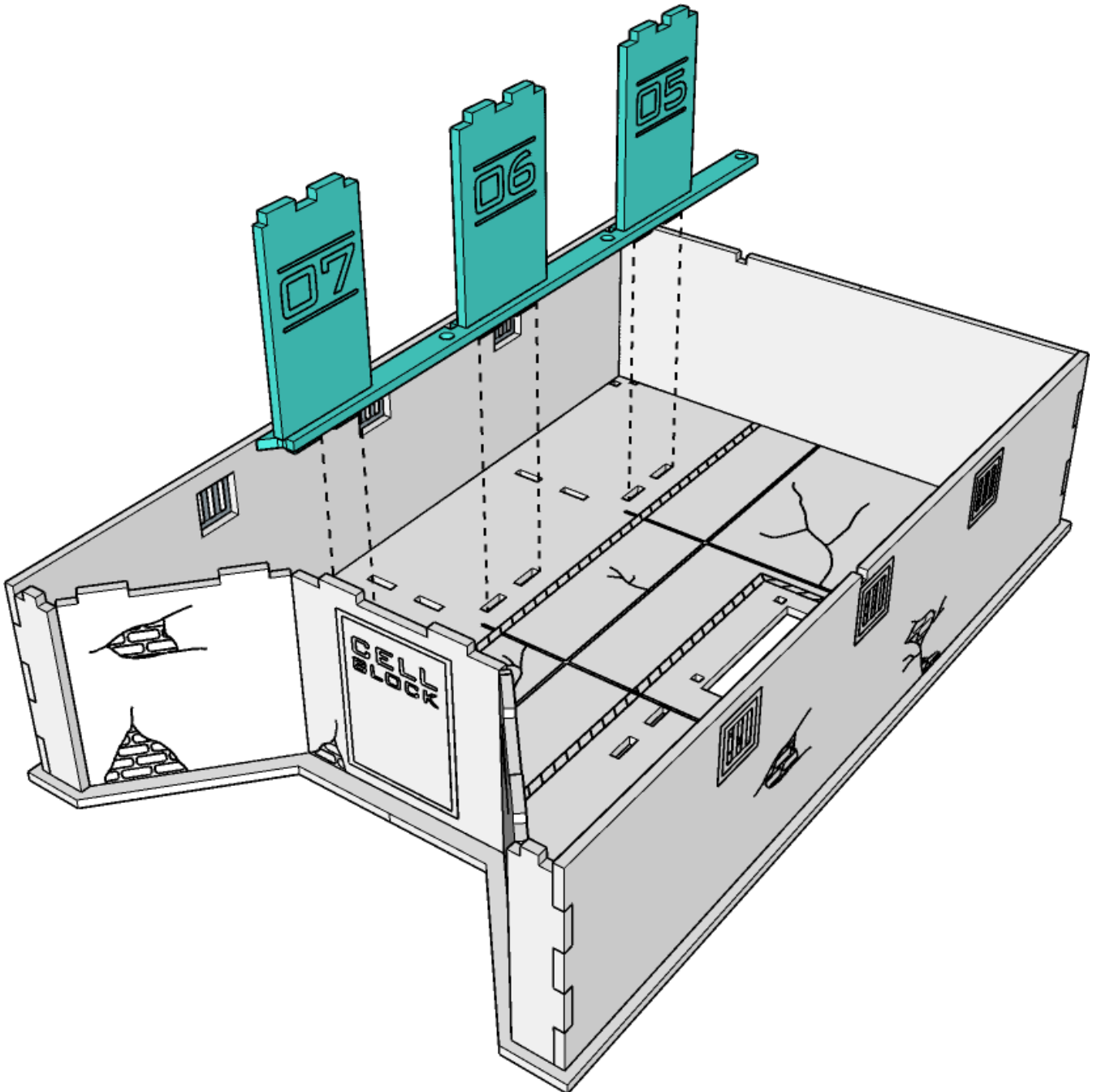

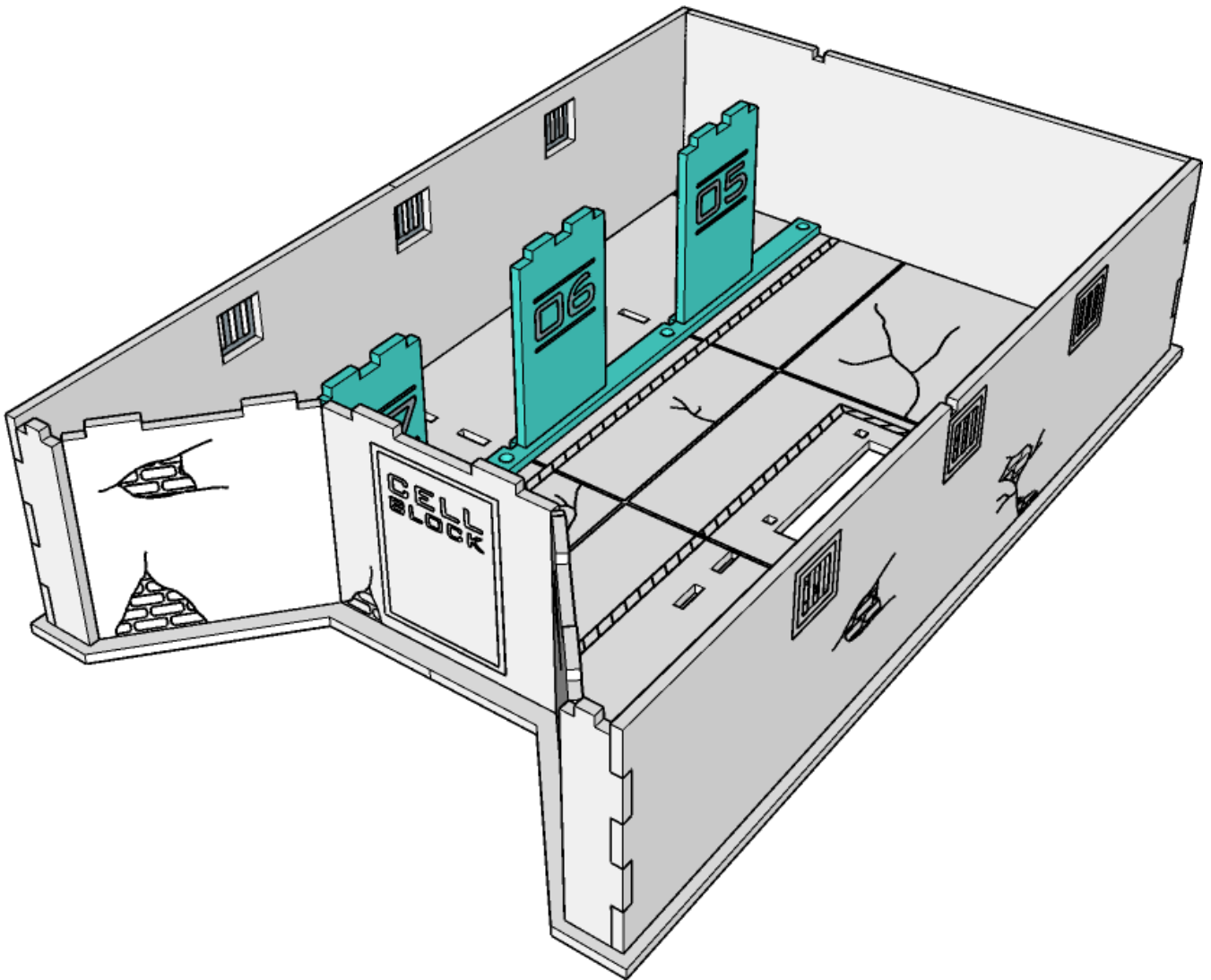

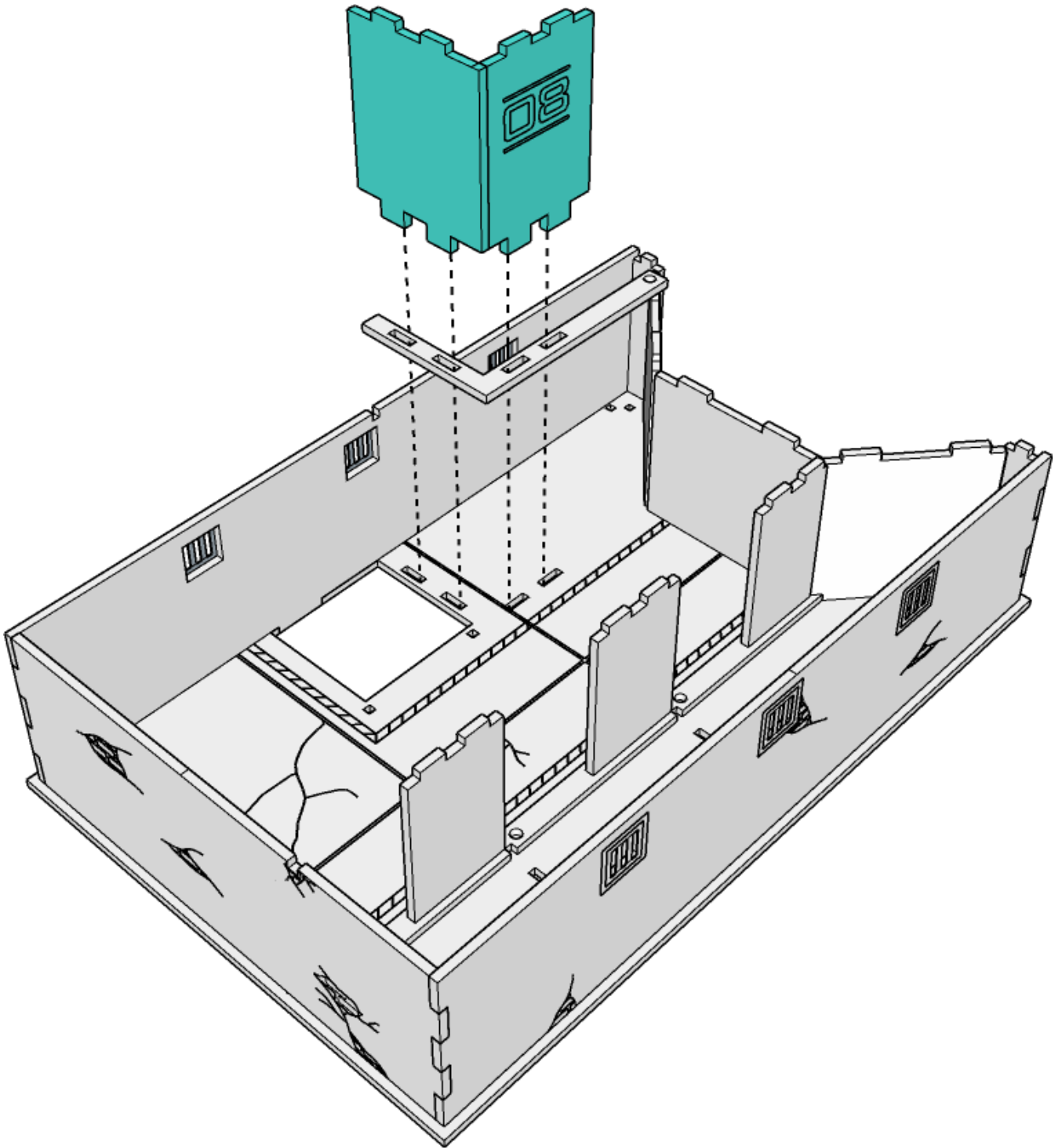

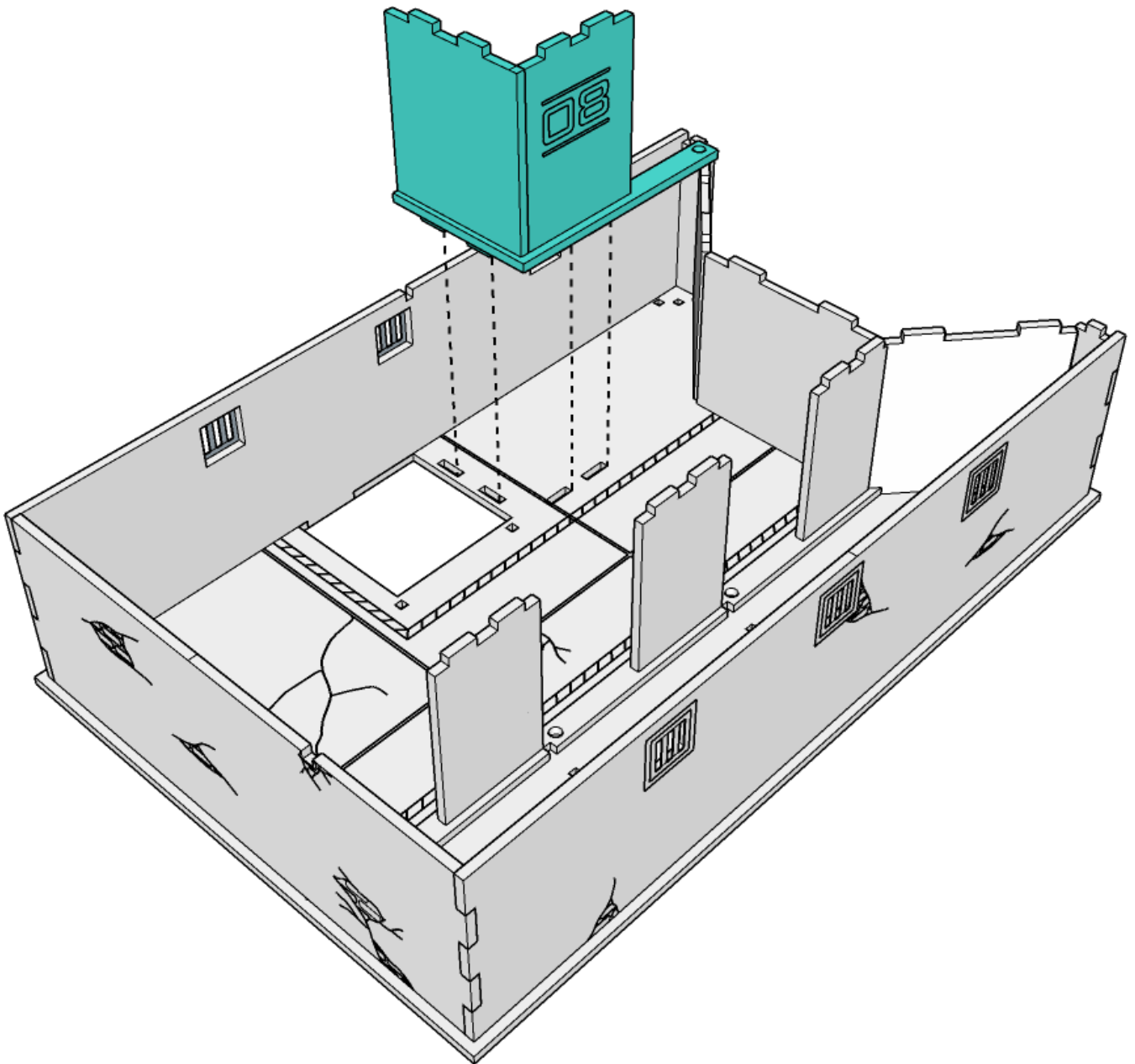



TABLETOP
SCENICS

TTSCW-DCS-158
PCPD: Cell Block

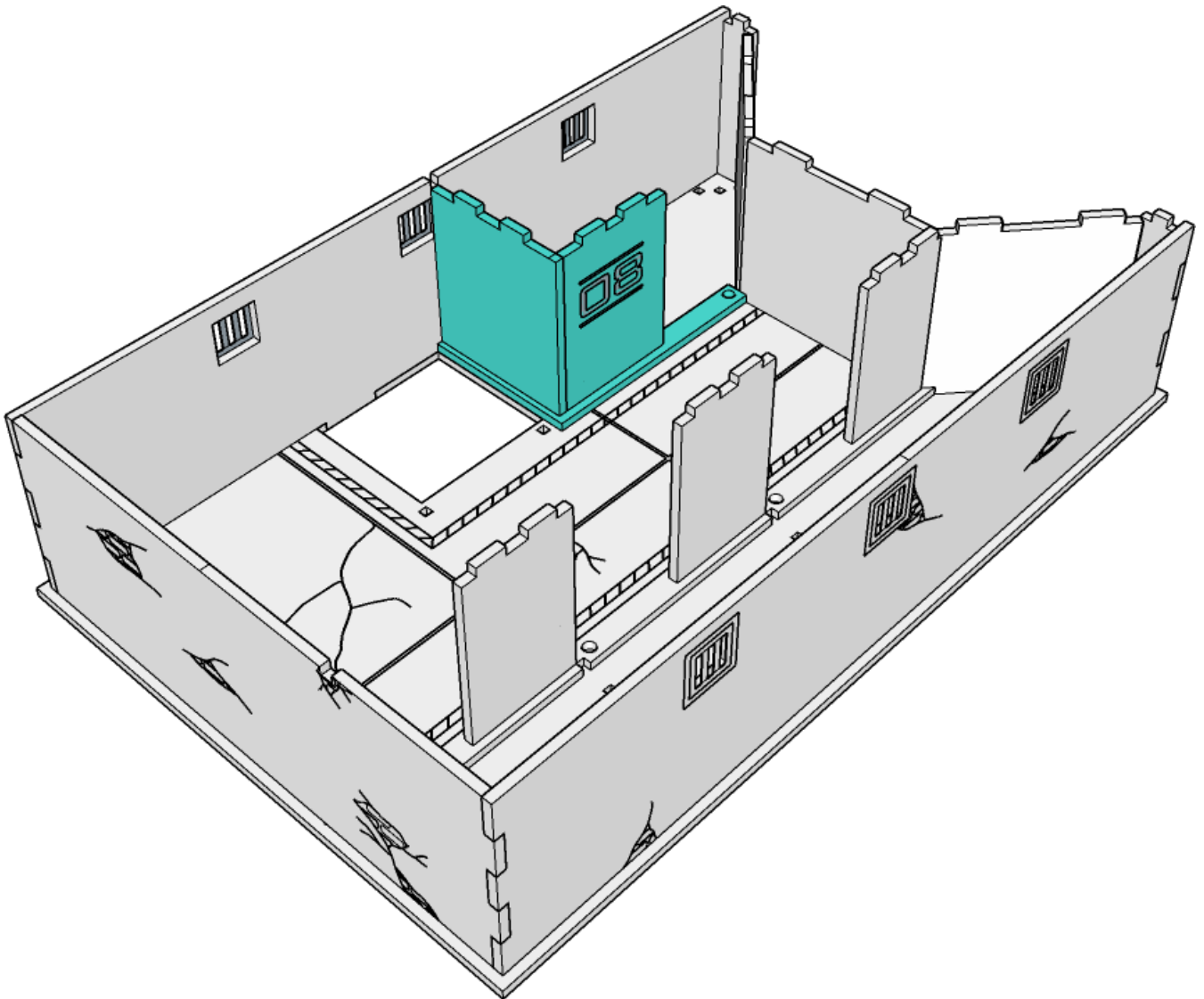



TABLETOP
SCENICS

TTSCW-DCS-158
PCPD: Cell Block

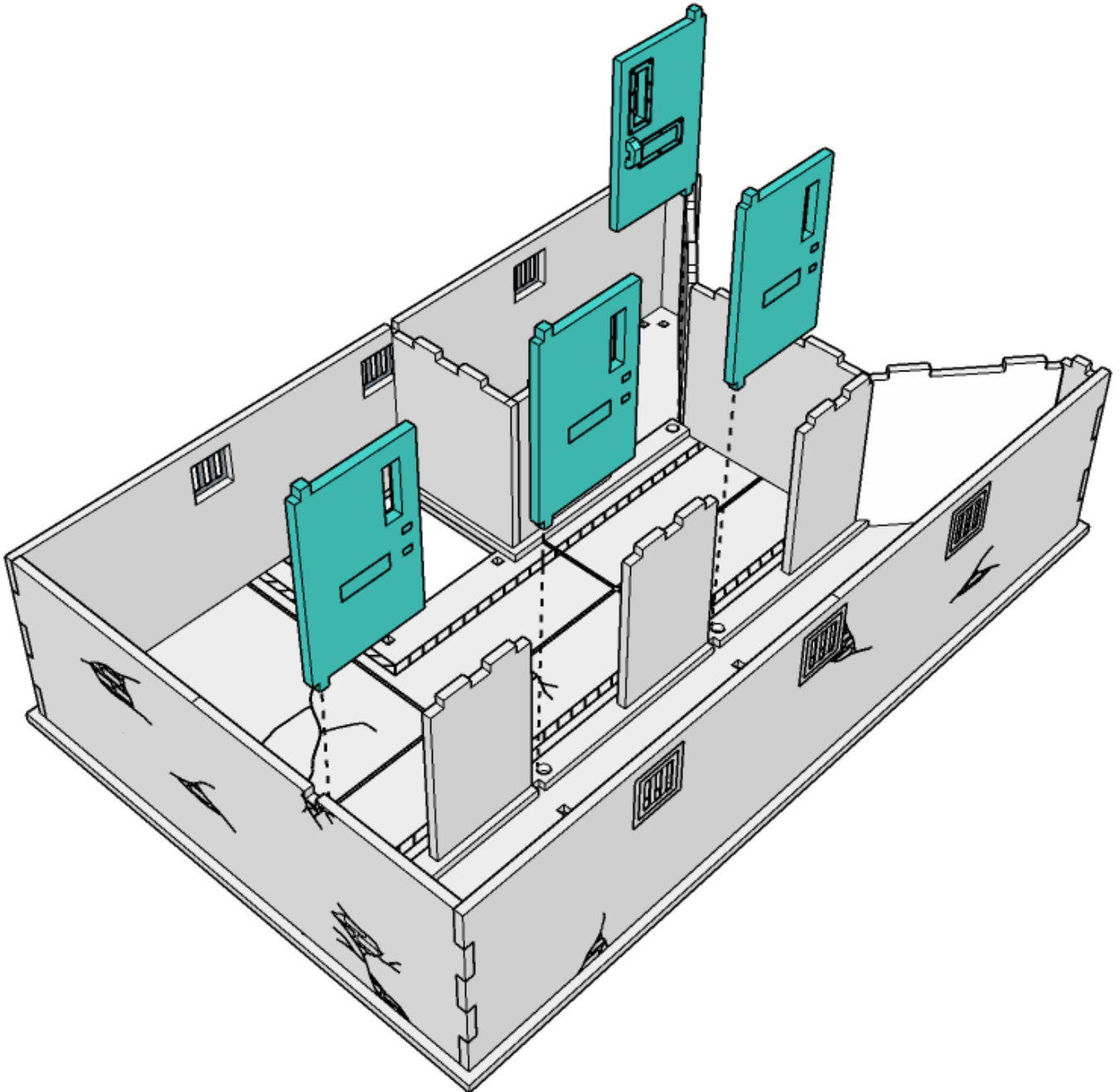

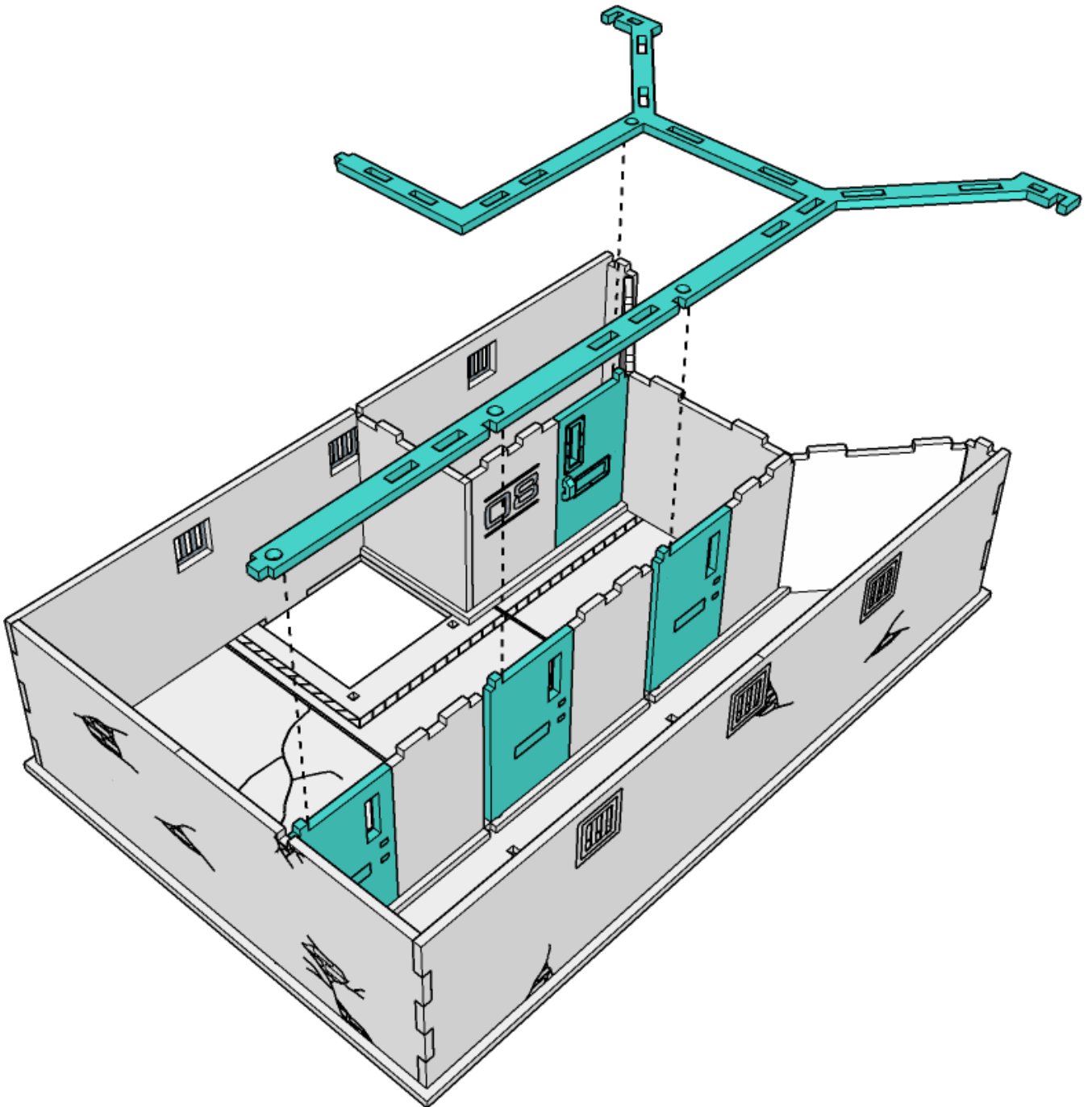

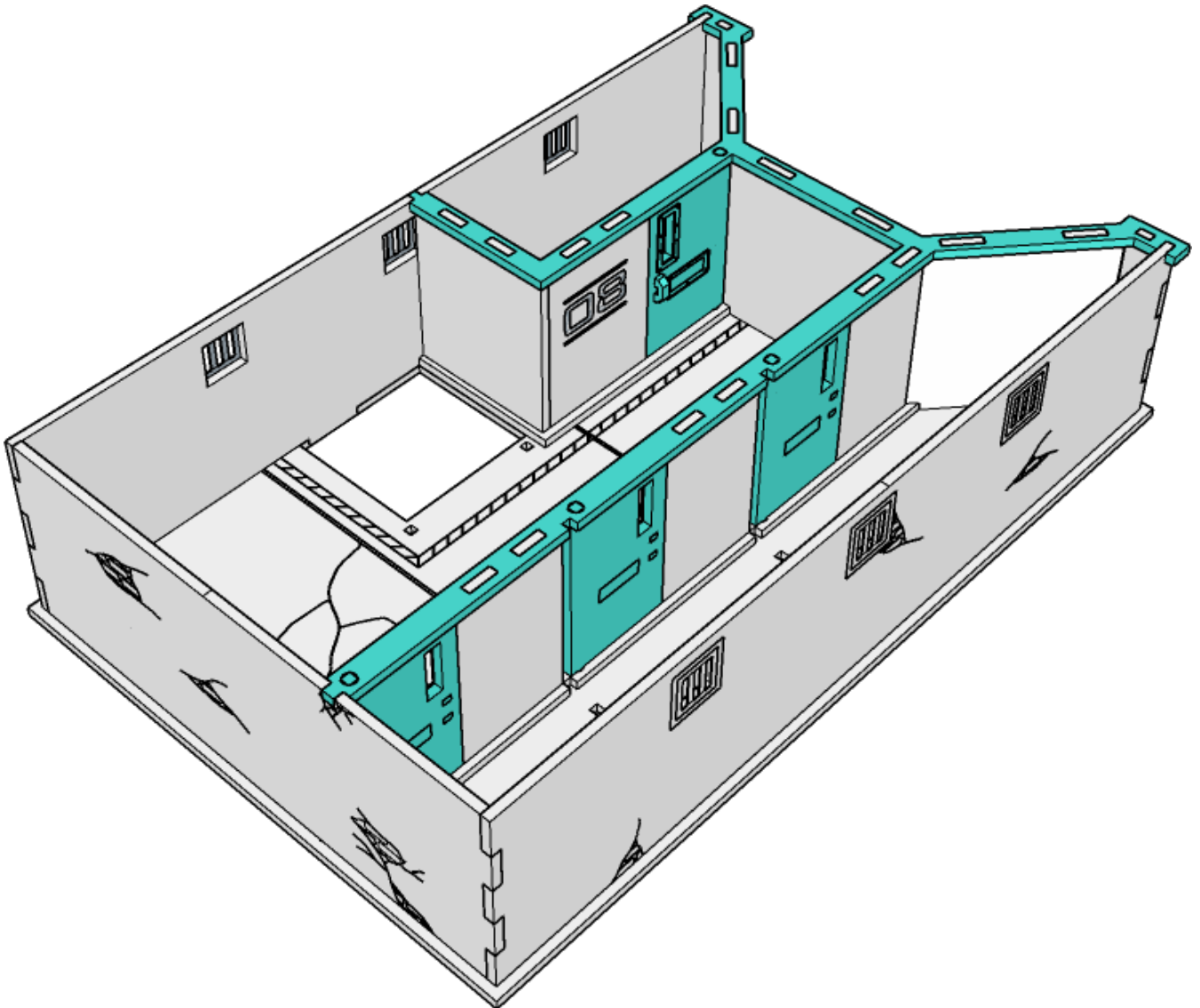



TABLETOP
SCENICS

TTSCW-DCS-158
PCPD: Cell Block

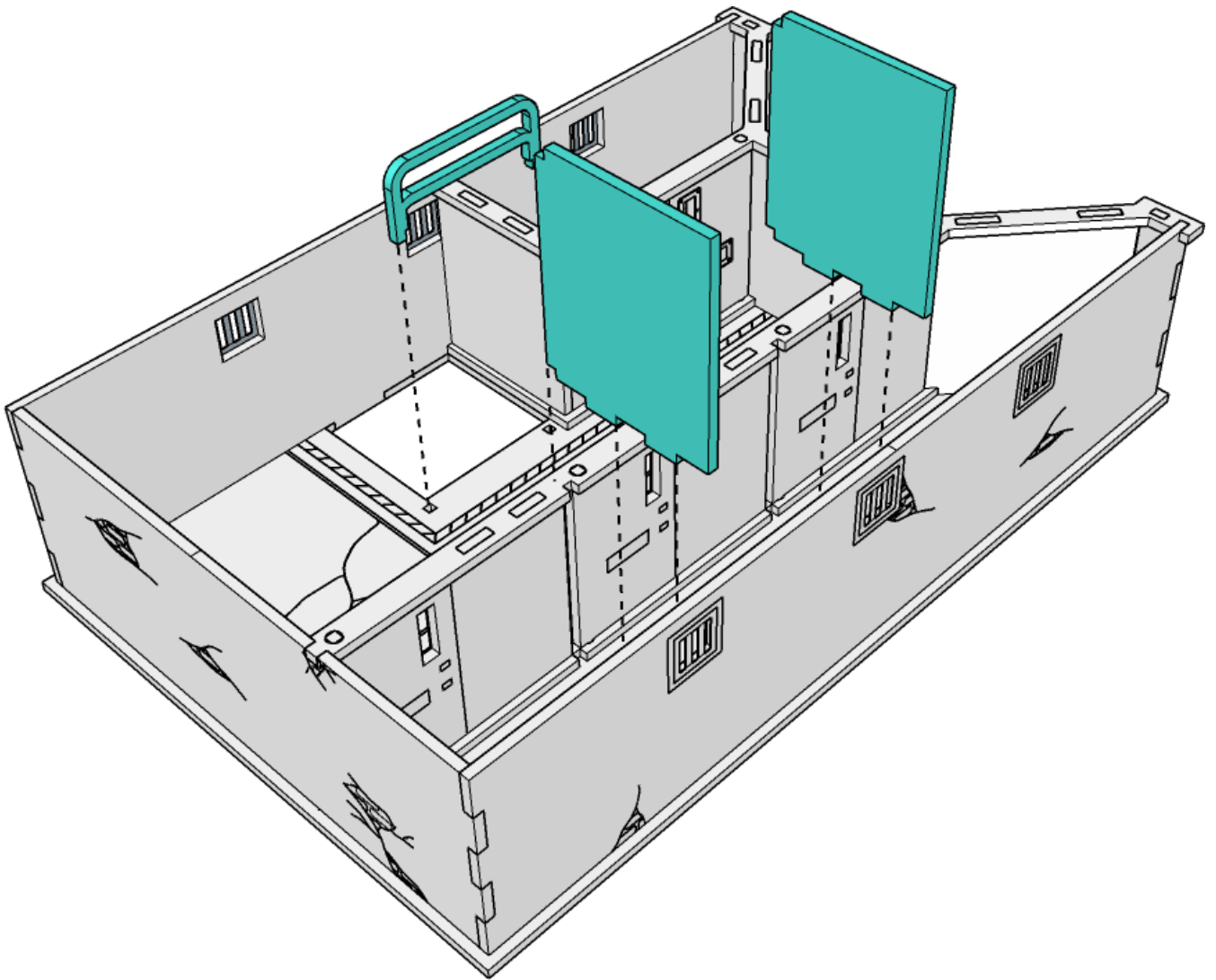

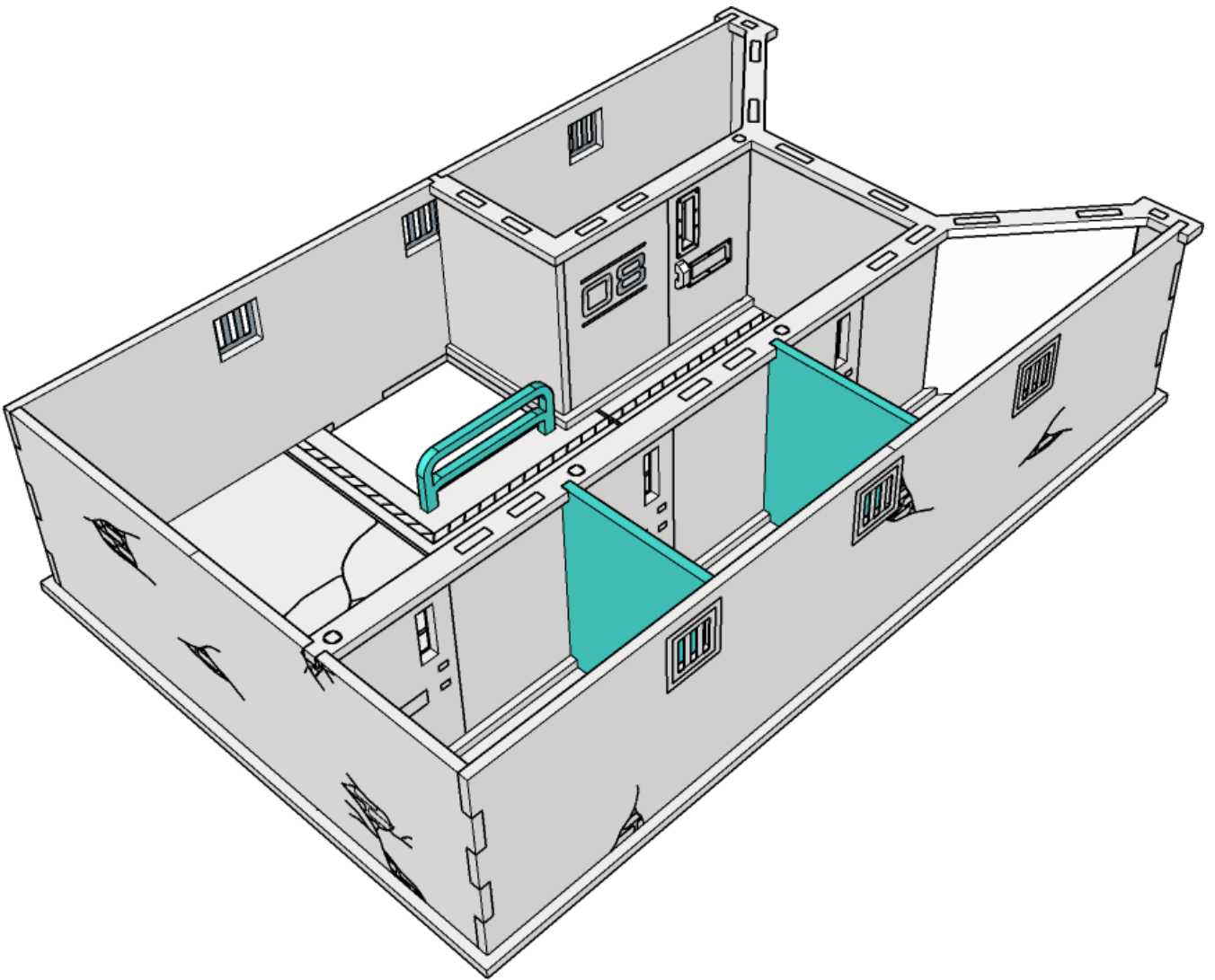



TABLETOP SCENICS

TTSCW-DCS-158
PCPD: Cell Block

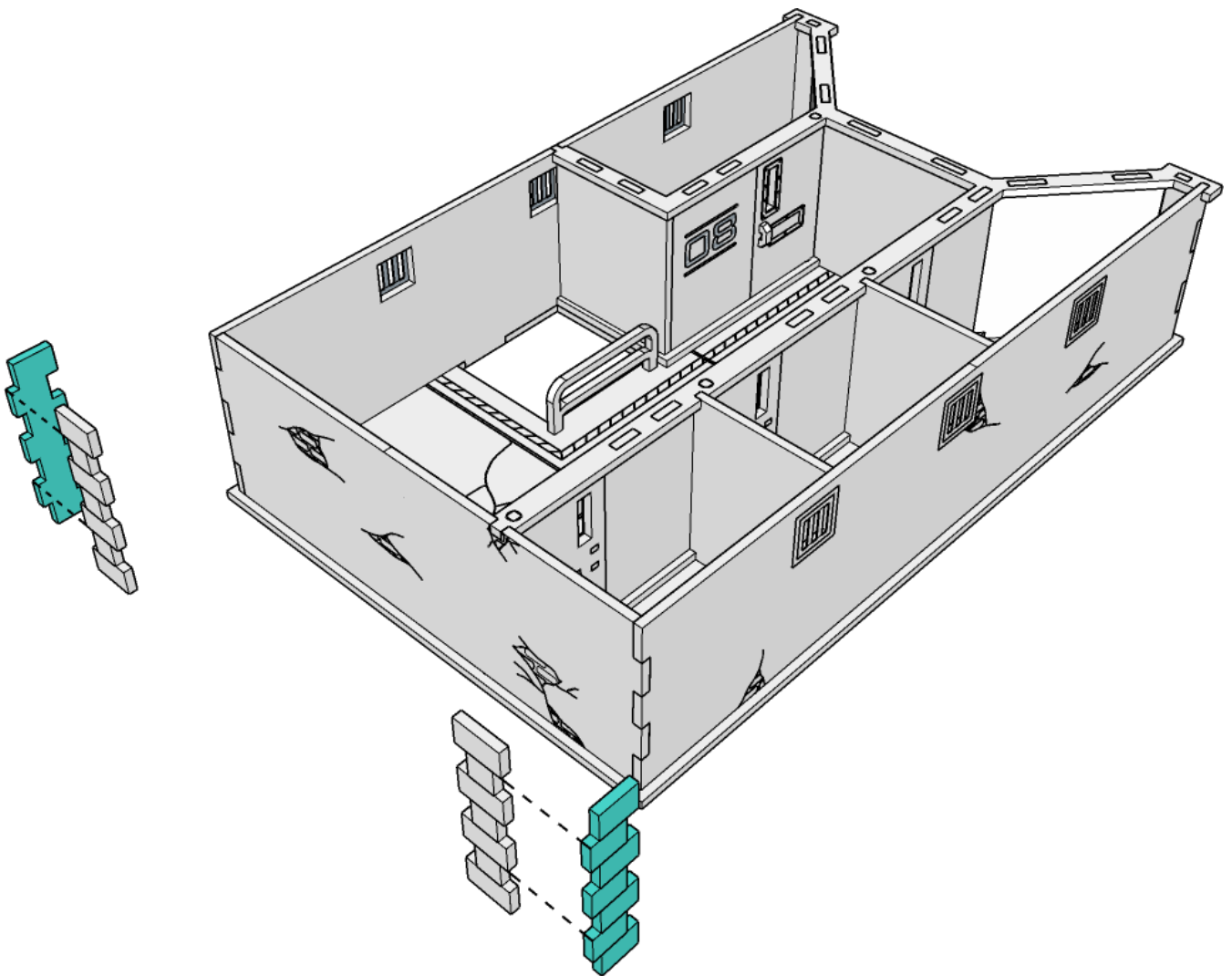

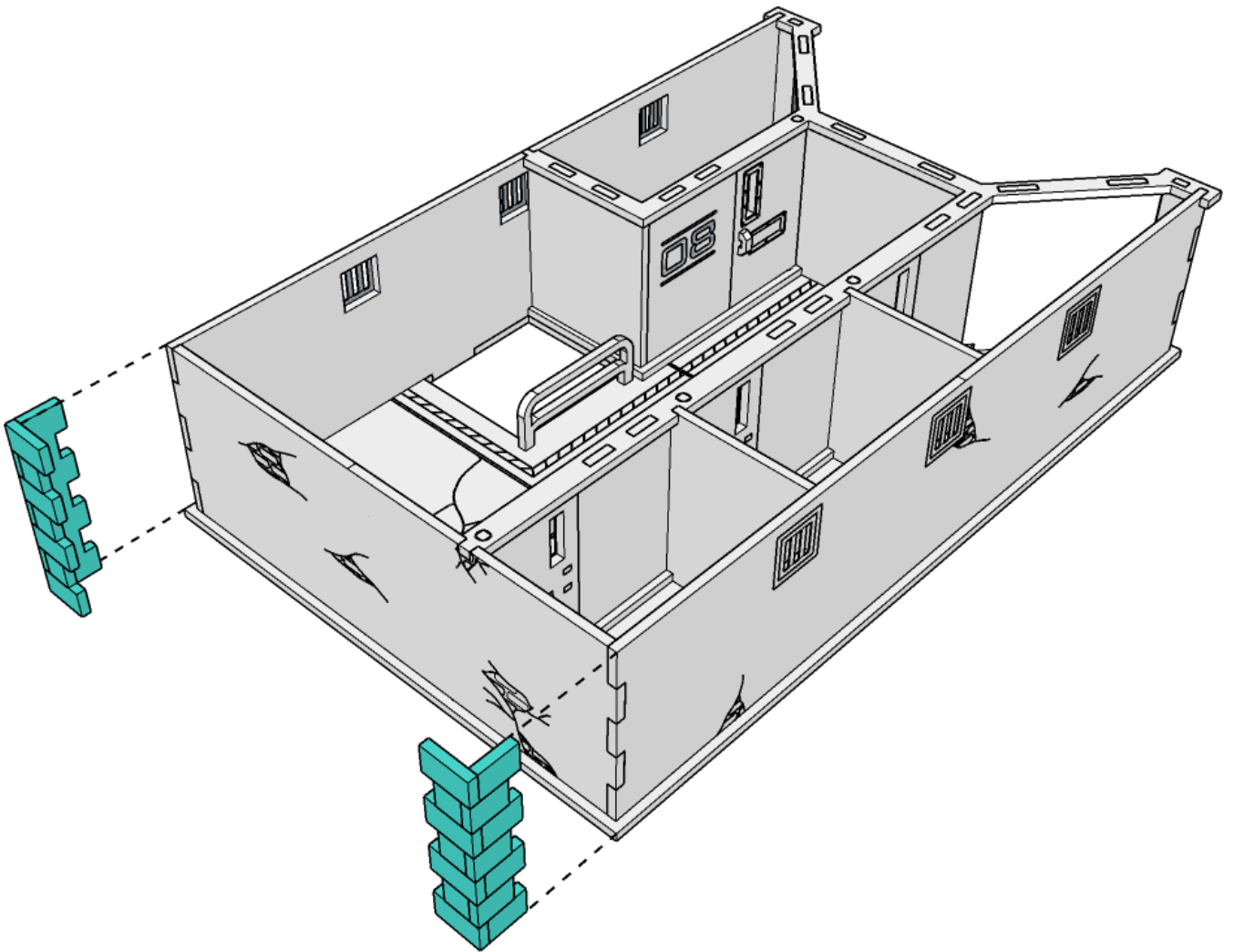



**TABLETOP
SCENICS**

**TTSCW-DCS-158
PCPD: Cell Block**

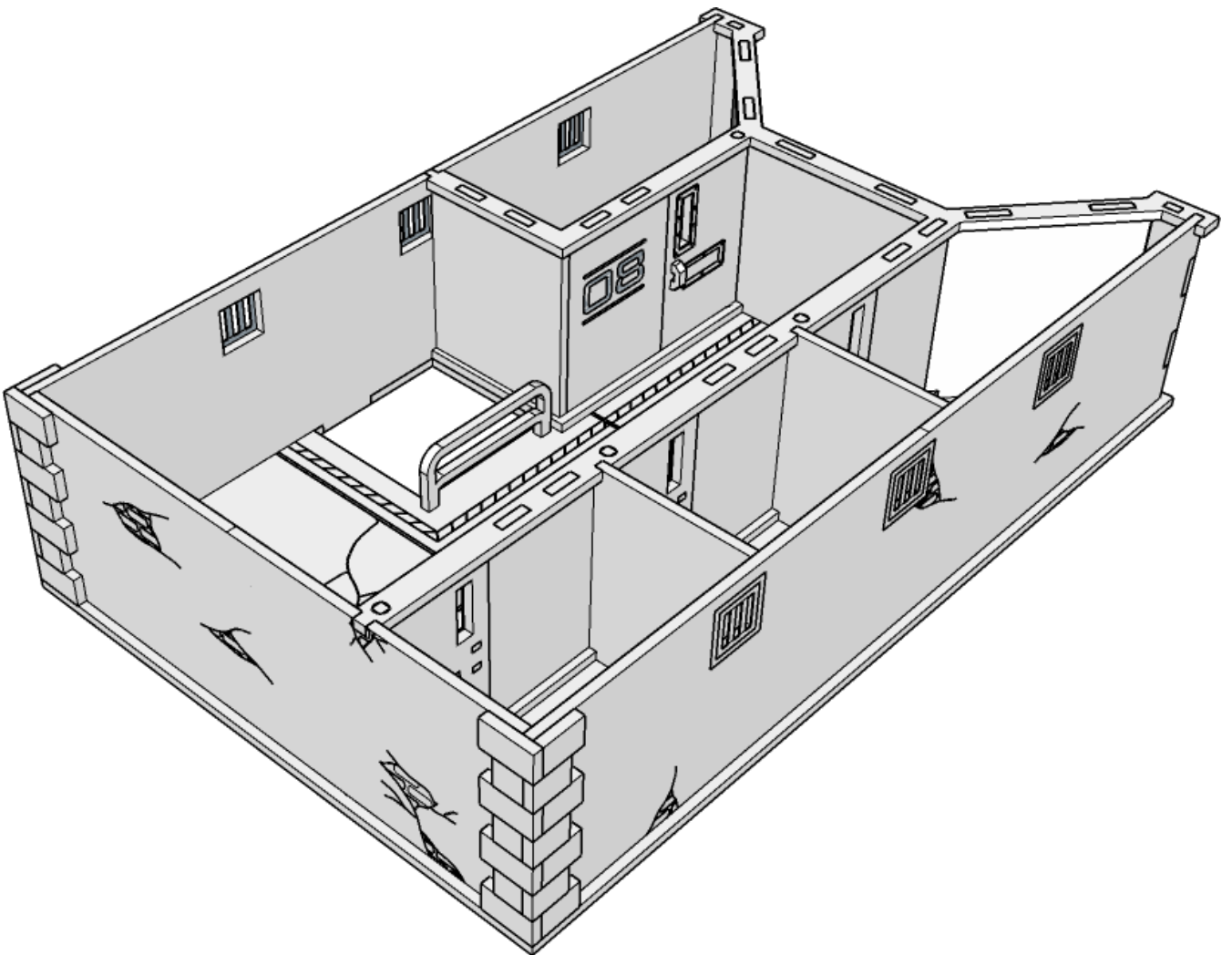

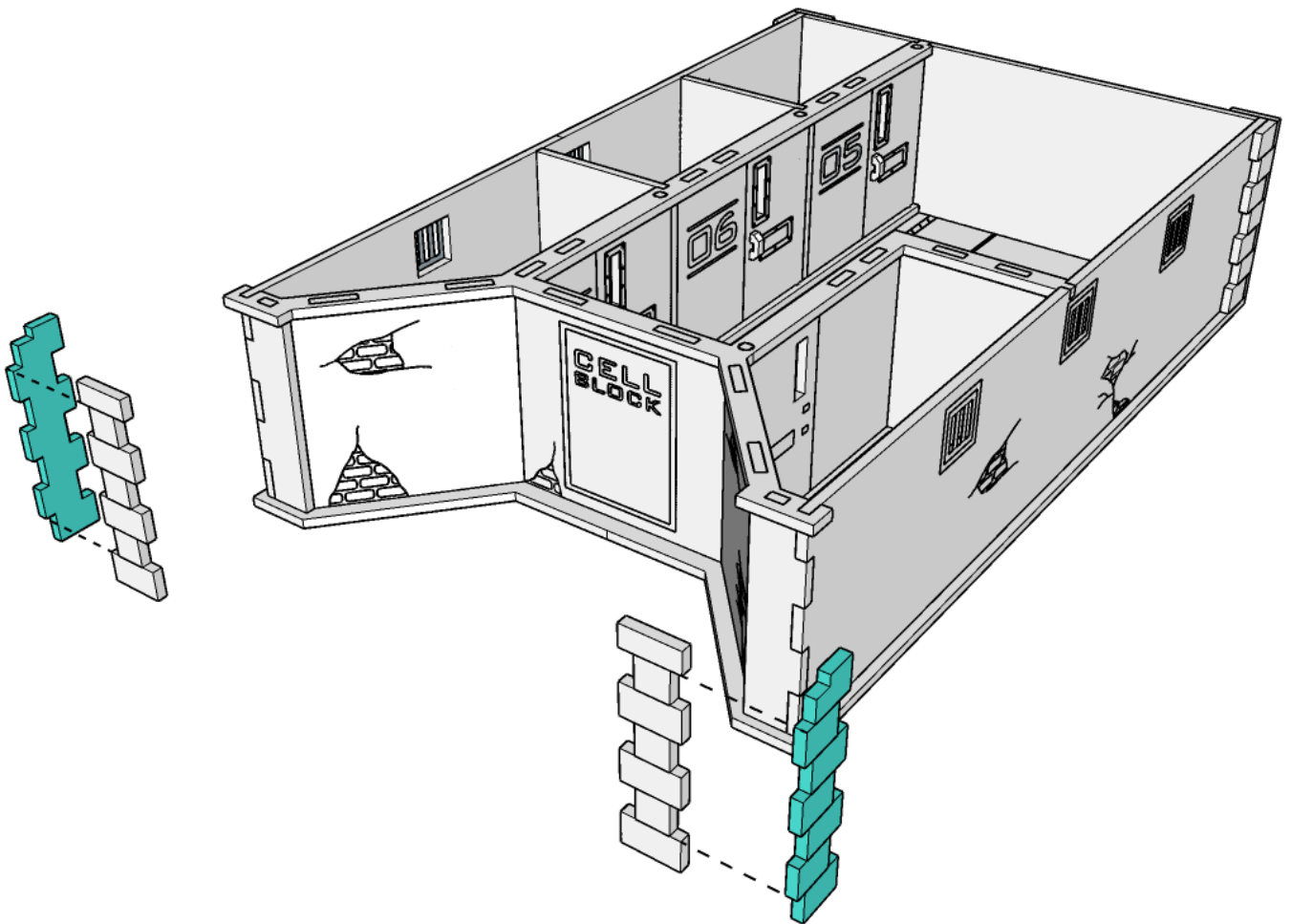

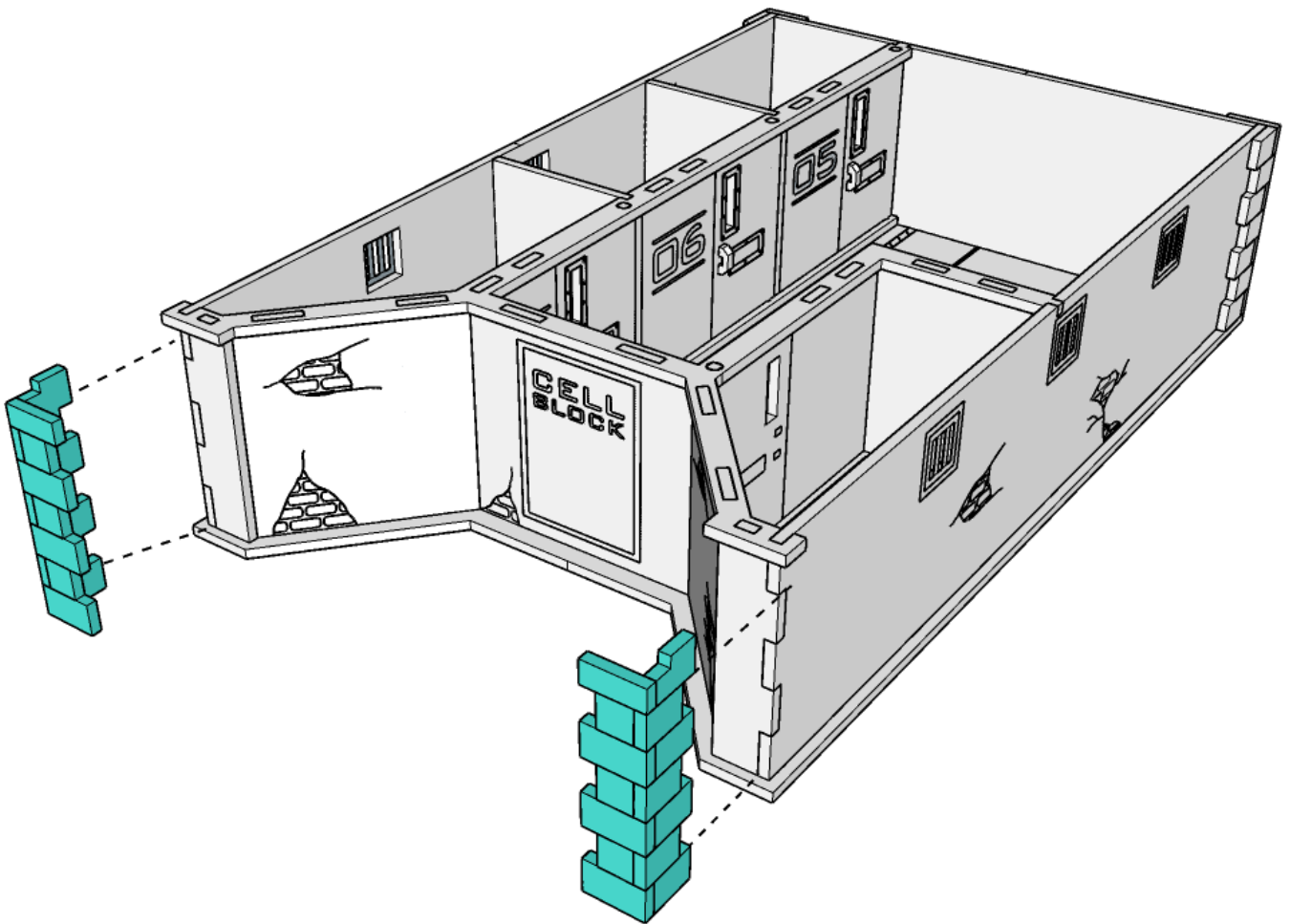

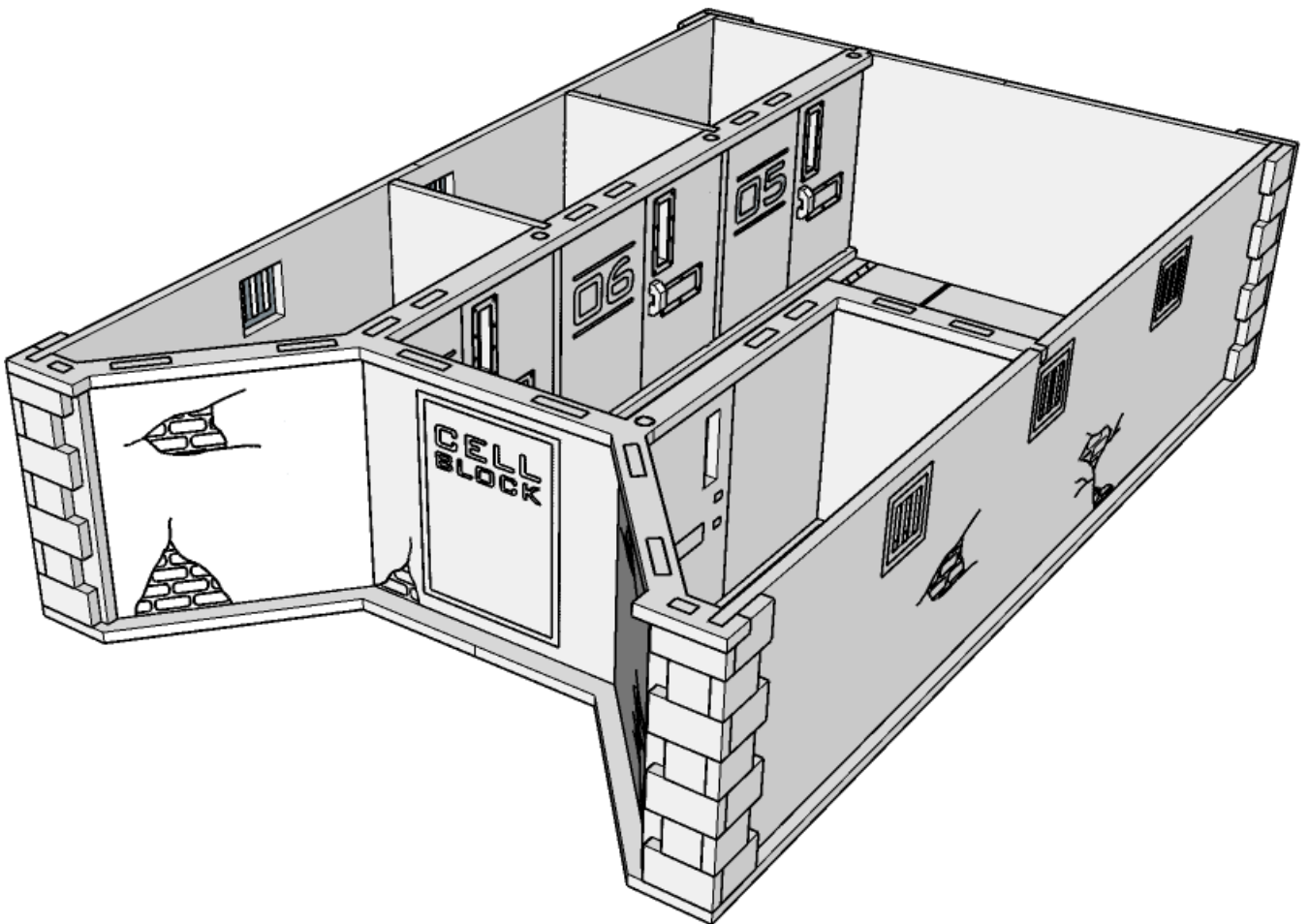

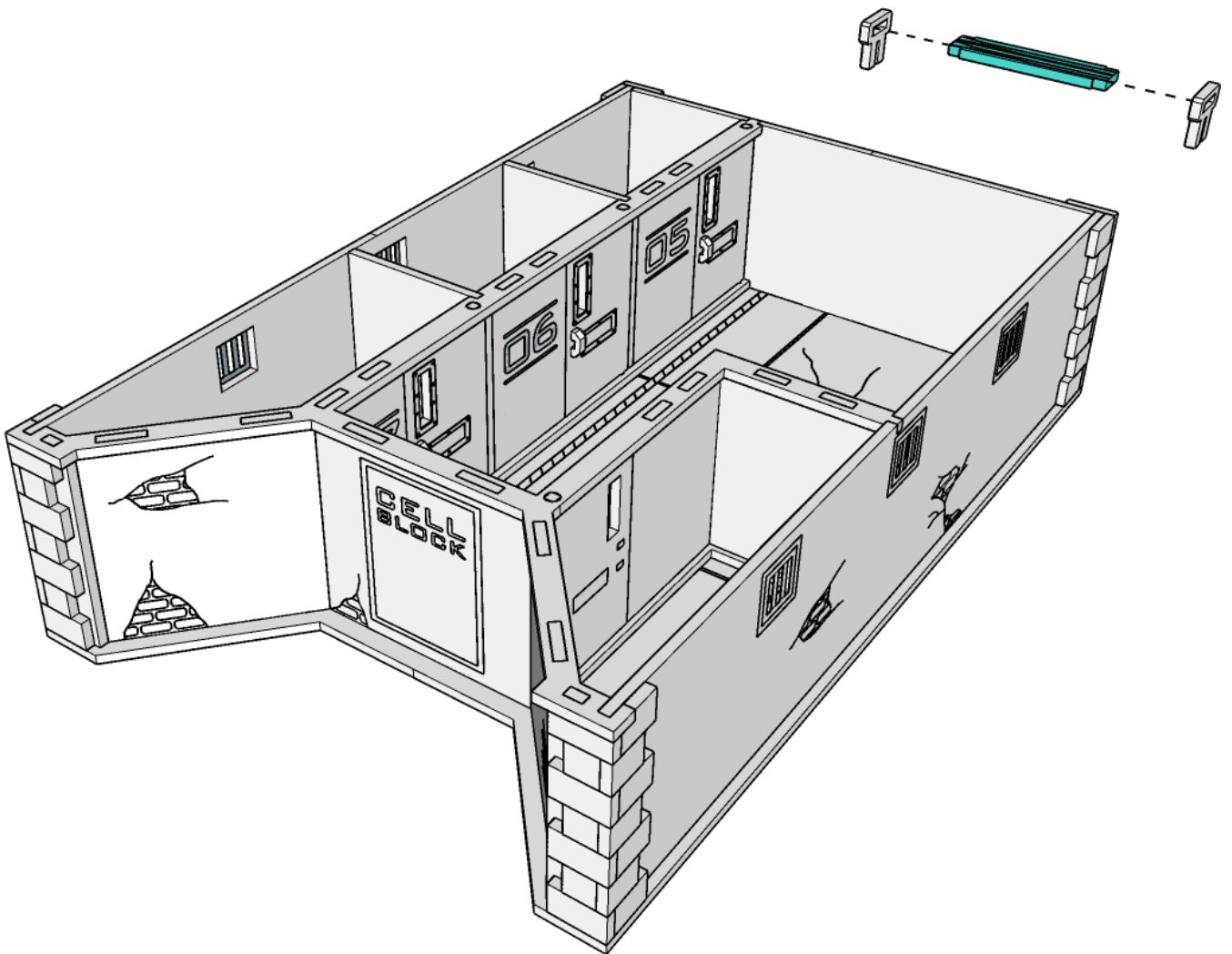

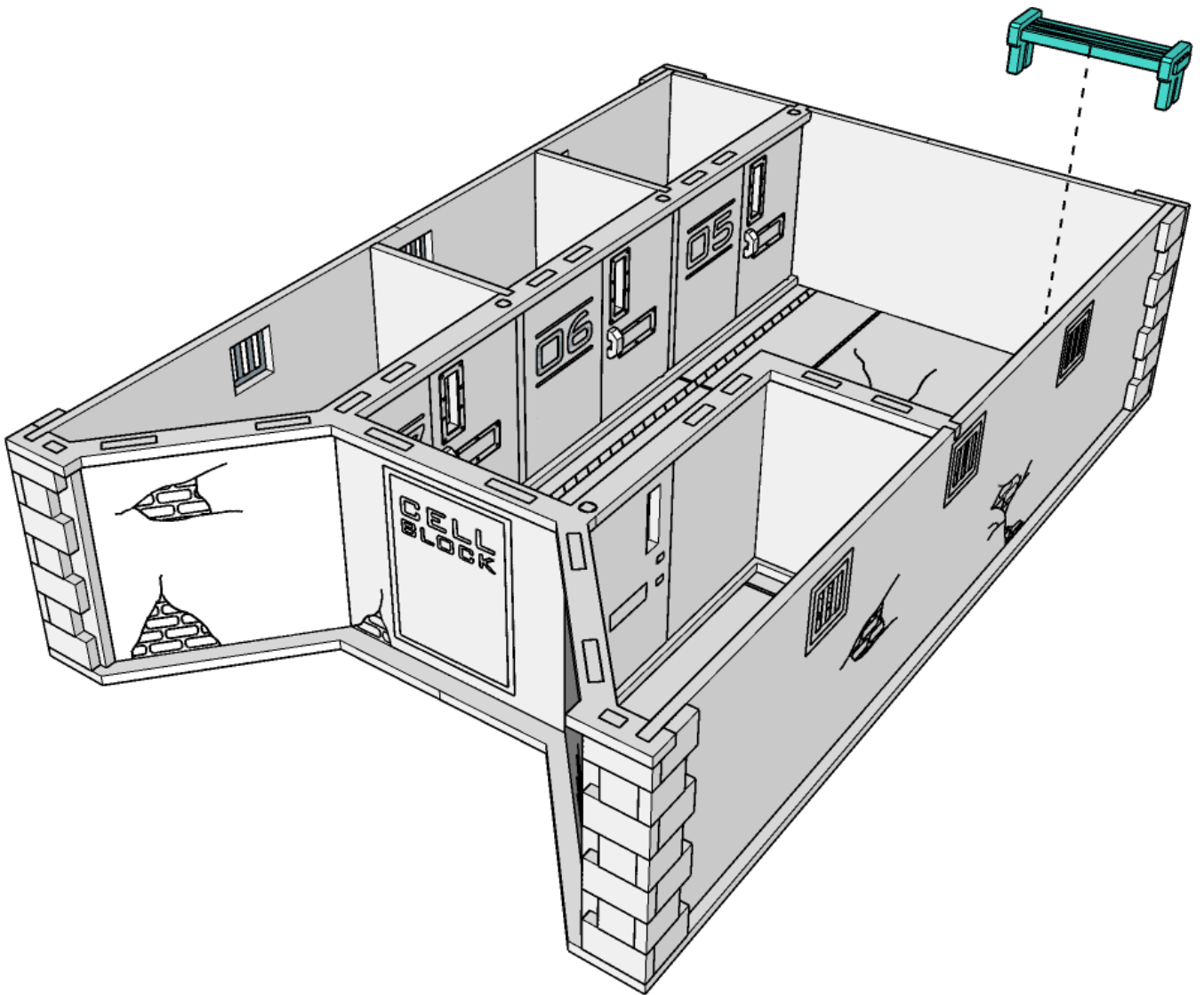

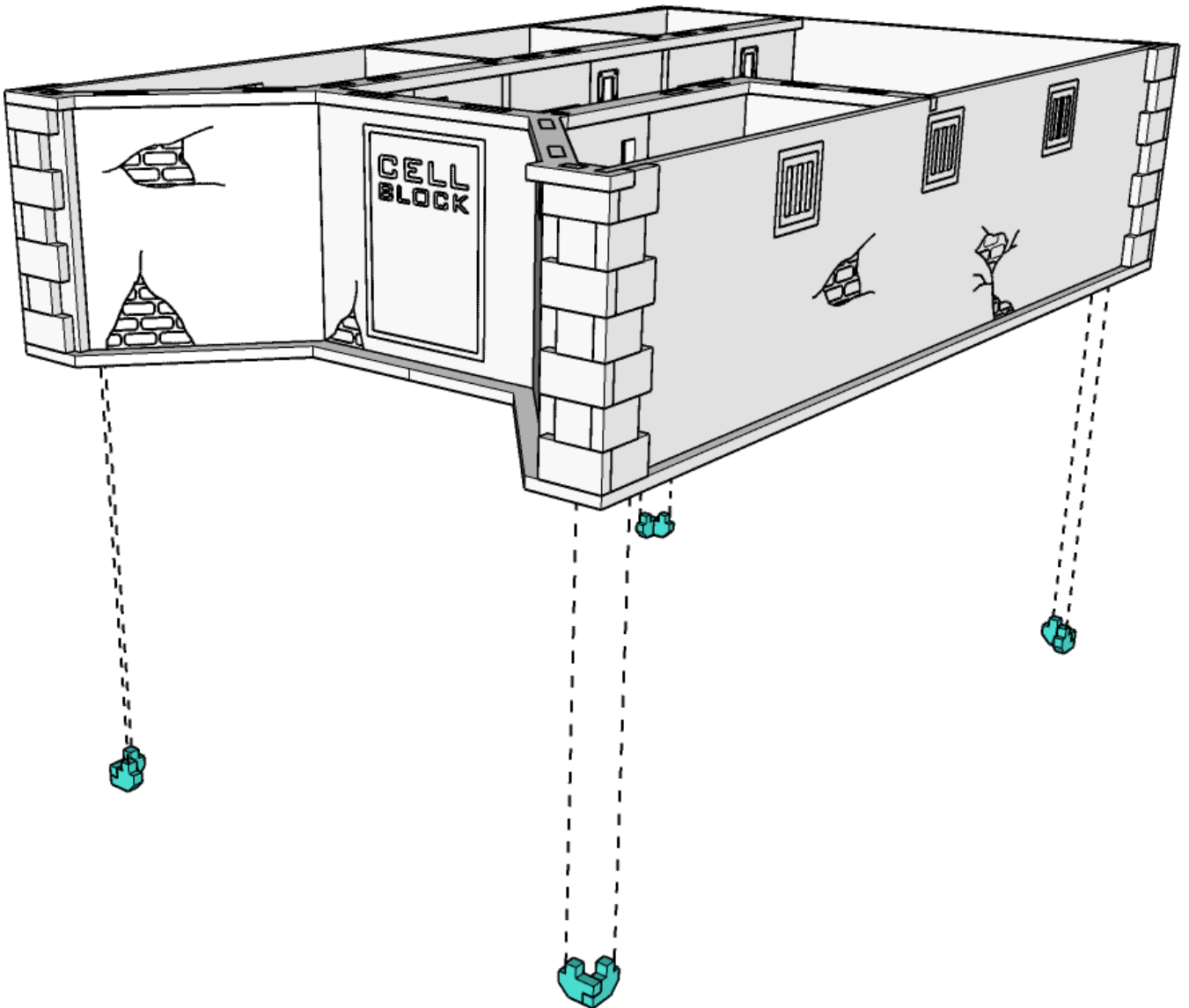



TABLETOP
SCENICS

TTSCW-DCS-158
PCPD: Cell Block

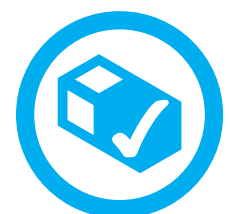
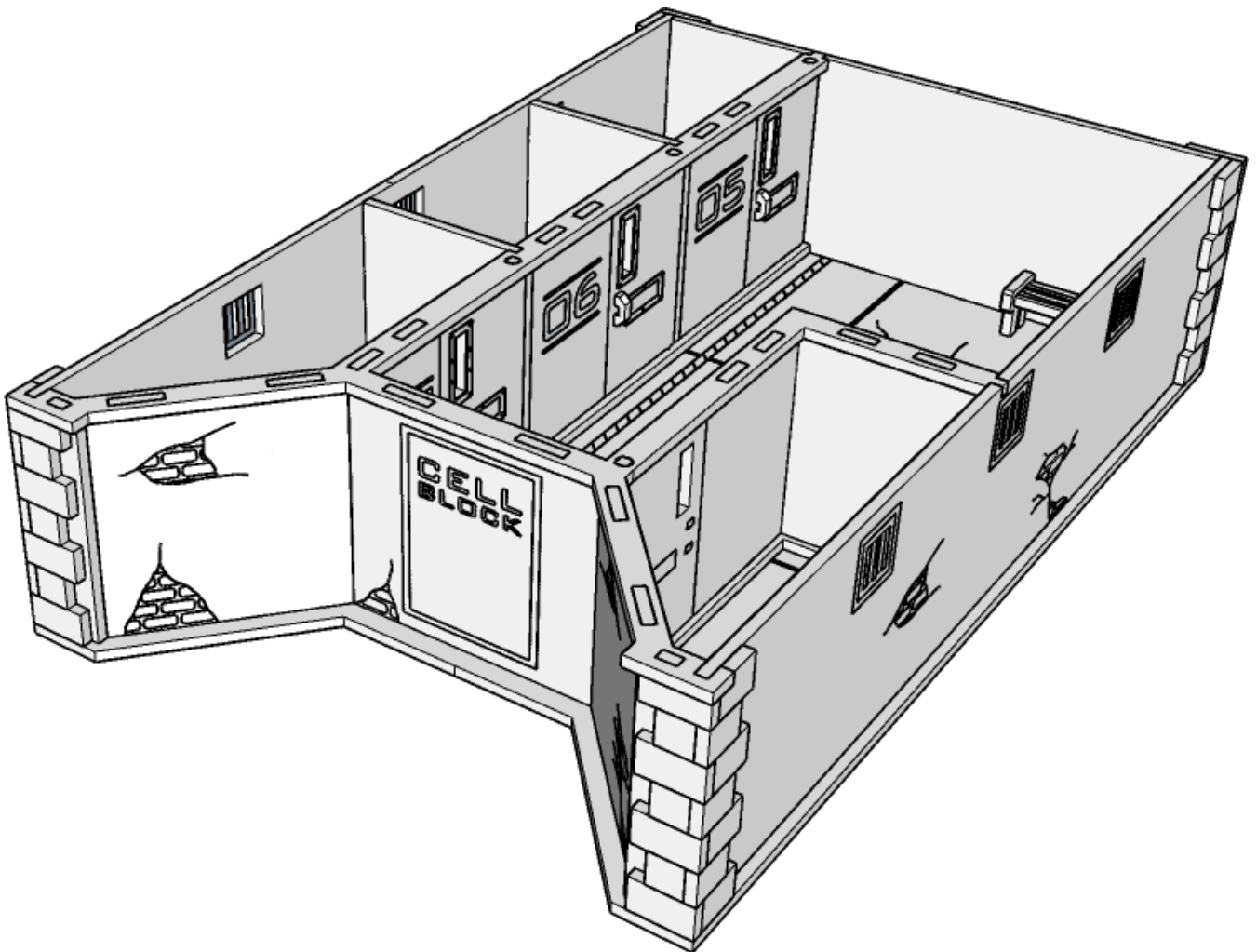



TABLETOP
SCENICS

TTSCW-DCS-158
PCPD: Cell Block

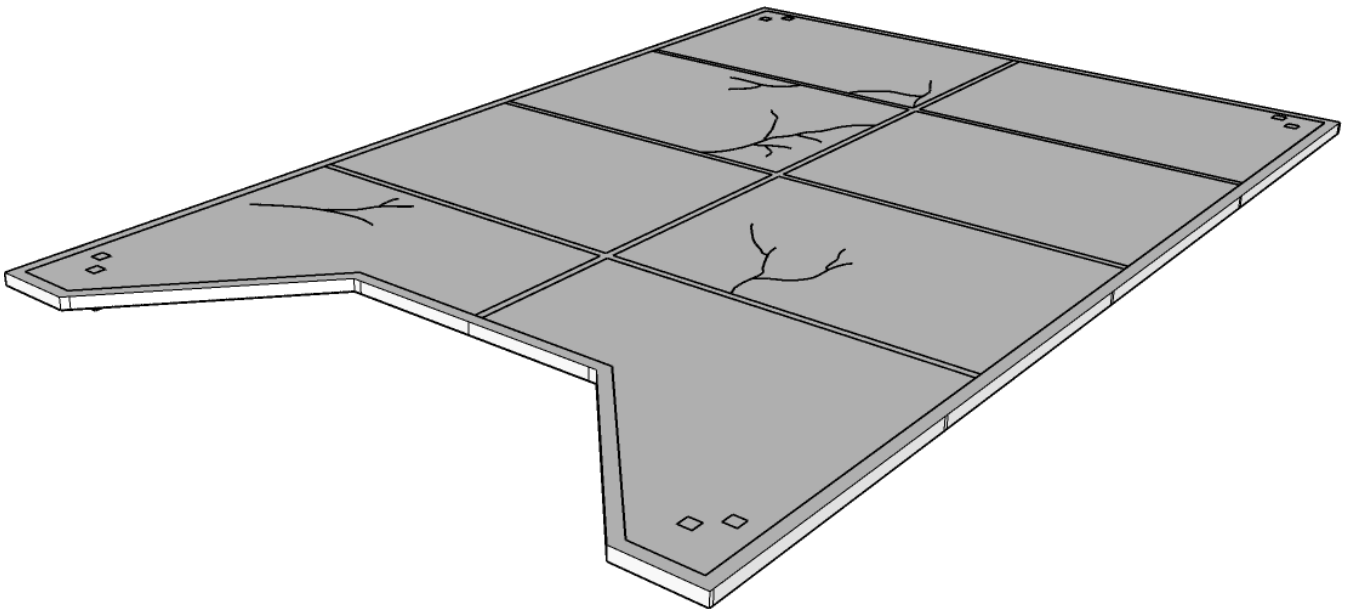

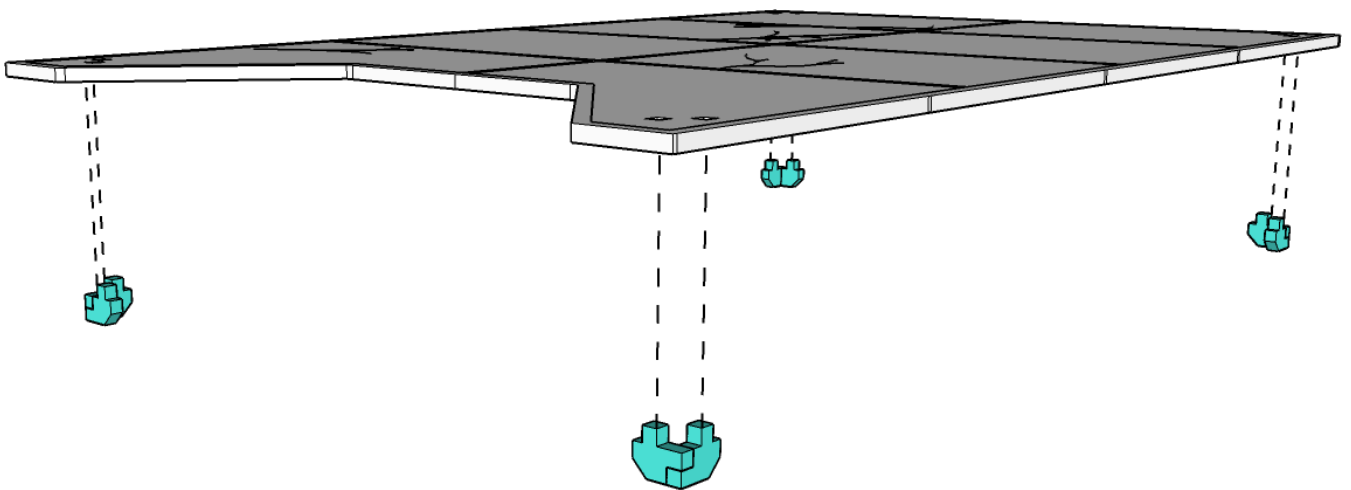



TABLETOP
SCENICS

TTSCW-DCS-158
PCPD: Cell Block

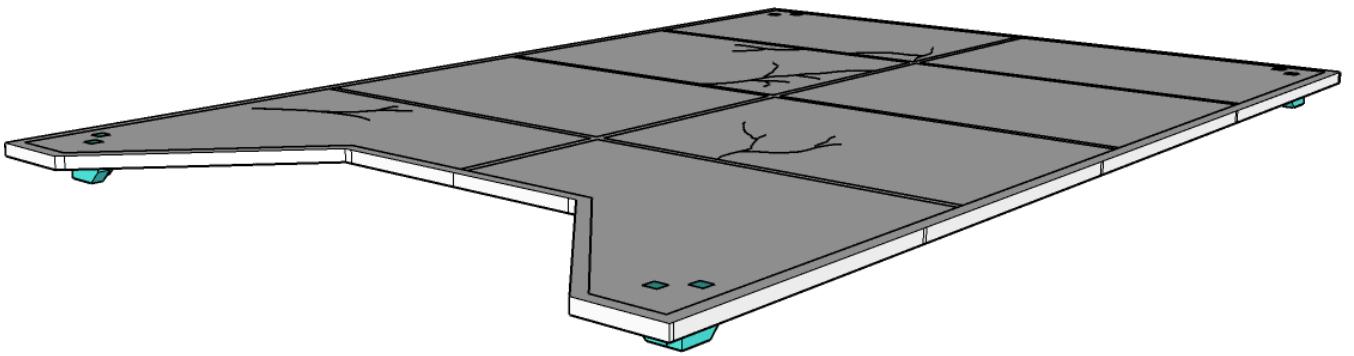



TABLETOP
SCENICS

TTSCW-DCS-158
PCPD: Cell Block

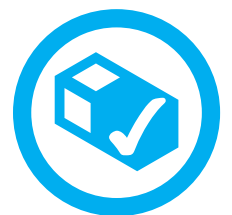
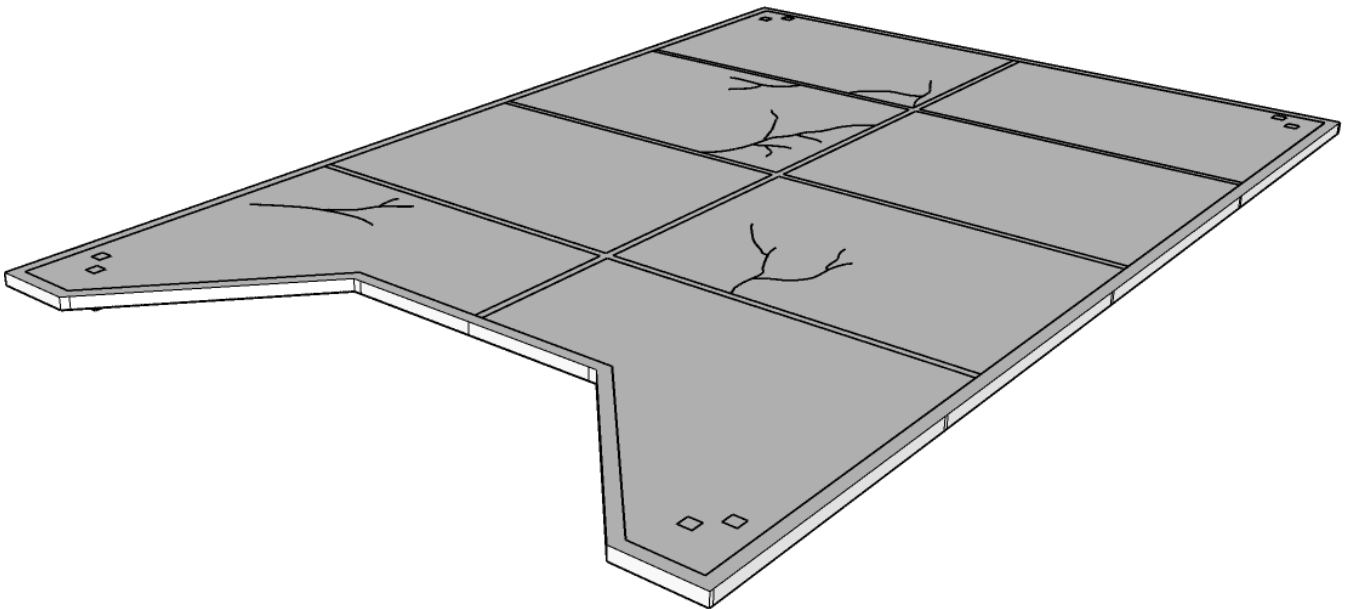



TABLETOP
SCENICS

TTSCW-DCS-158
PCPD: Cell Block

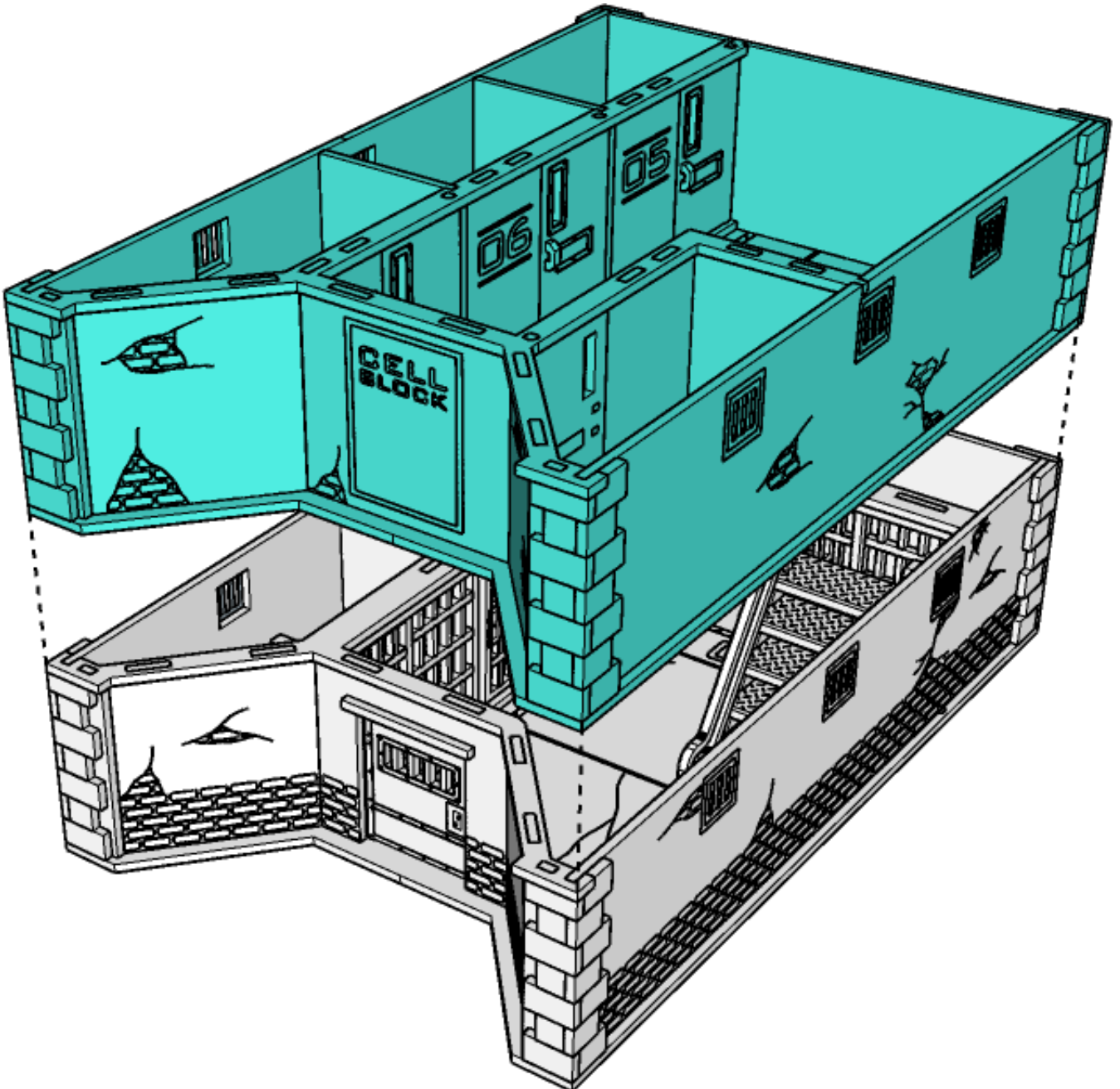



TABLETOP
SCENICS

TTSCW-DCS-158
PCPD: Cell Block

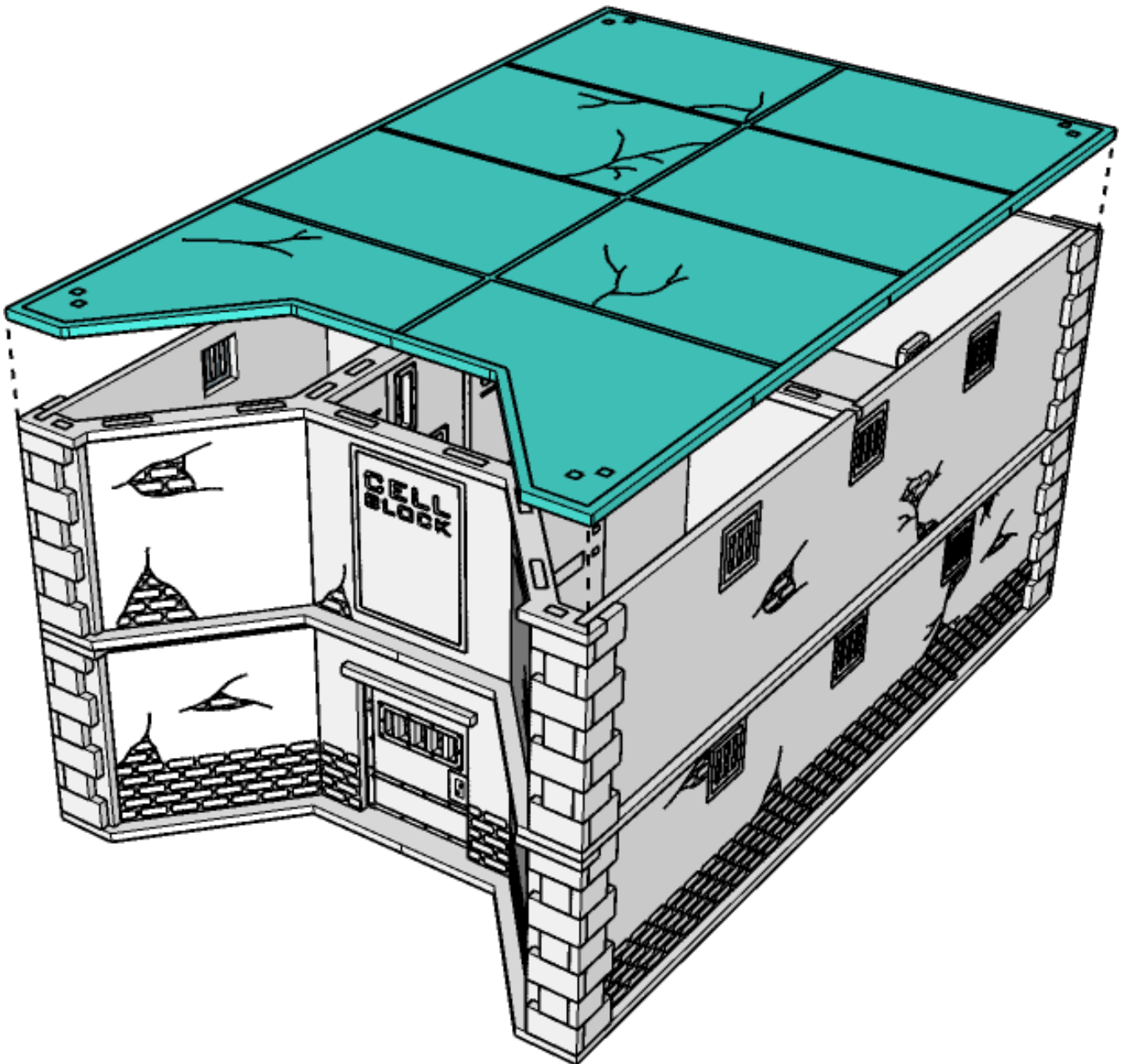



TABLETOP
SCENICS

TTSCW-DCS-158
PCPD: Cell Block

