

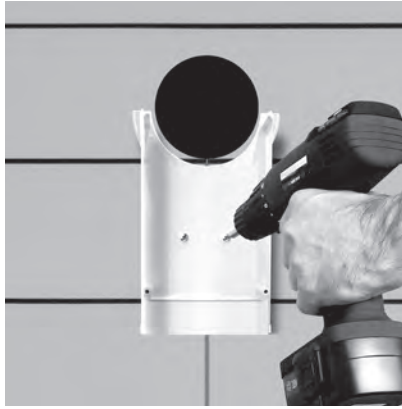

Installation instructions

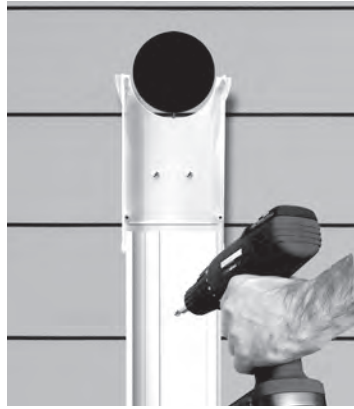

(1) Determine the path which the lineset will follow and strike a chalk line to mark the surface material. Attach the base only of all fittings first (ducting will be placed last), along the marked path, using fasteners of sufficient length (not provided). Pre-drill where necessary. Duct must terminate **with a fitting to prevent cover from sliding out of position.**



(2) Once all fitting bases are secured to the siding, measure and cut LD Ducting to fit as needed. Remember to account for some seasonal expansion and contraction. Install and fasten LD Ducting bases. Attach bases only to structure through provided punch outs using fasteners of sufficient length (not provided).

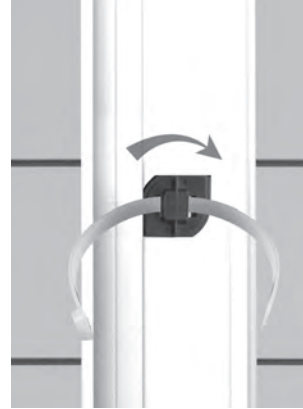

(3) Position and twist in lineset duct clips (Model# LDC) evenly spaced throughout installation. Nylon cable ties (not included) slip through lineset duct clips and fasten around lineset.



(4) Run lineset, drain hose, wiring etc. over the fitting and duct bases and secure to duct clips using tie wraps of sufficient size.



(5) Snap straight duct top over mating straight base pieces. Seat fitting tops over mating fitting bases and secure with provided stainless screws. Duct **must** terminate with a fitting to prevent cover from sliding out of position. **If duct is to be painted, or duct is a dark color, adhere cover to base with pvc cement.**

Typical lineset* capacity LD-92 3 1/2" W x 2 1/2" D

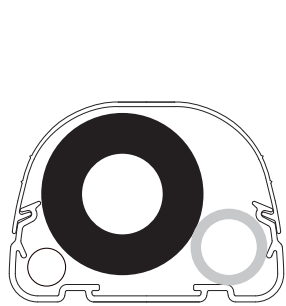

LD-92 w/Single 1 1/8" Lineset
BTU - 60,000
Suction Line - 1 1/8" OD
(Insulation) - 1/2"
Liquid Line - 1/2" OD
Drain Line - 3/4" PVC

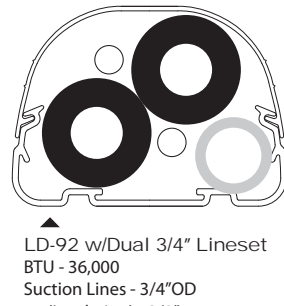

LD-92 w/Dual 3/4" Lineset
BTU - 36,000
Suction Lines - 3/4" OD
(Insulation) - 3/8"
Liquid Lines - 3/8" OD
Drain Line - 3/4" PVC

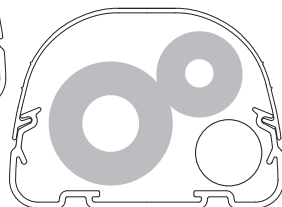

LD-92 w/Single 3/4" Lineset
BTU - 42,000
Suction Line - 3/4" OD
(Insulation) - 1/2"
Liquid Line - 3/8" OD
(Insulation) - 1/2"
Drain Hose - 7/8" OD

LD-122 4 1/2" W x 3 1/4" D

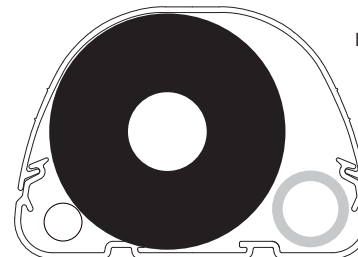

LD-122 w/Single 1 1/8" Lineset
BTU - 60,000
Suction Line - 1 1/8" OD
(Insulation) - 1"
Liquid Line - 1/2" OD
Drain Line - 3/4" PVC

LD-122 w/Dual 3/4" Lineset
BTU - 42,000
Suction Lines - 3/4" OD
(Insulation) - 1/2"
Liquid Lines - 3/8" OD
(Insulation) - 1/2"
Drain Hose - 7/8" OD

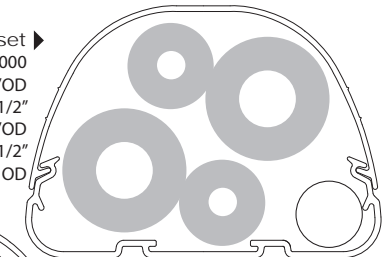

LD-122 w/Dual 3/4" Lineset
BTU - 36,000
Suction Lines - 3/4" OD
(Insulation) - 1/2"
Liquid Lines - 3/8" OD
Drain Line - 3/4" PVC

* Lineset size may change on Seer Rating

Specialty fitting installation instructions

Flexible fitting

INLINE COUPLING

- (1) Secure fitting and duct bases to wall.
- (2) Cut LF duct to length and place in fitting.
- (3) Secure LF duct with split cap and two screws.
- (4) Secure duct into coupler by fitting second part of cap.

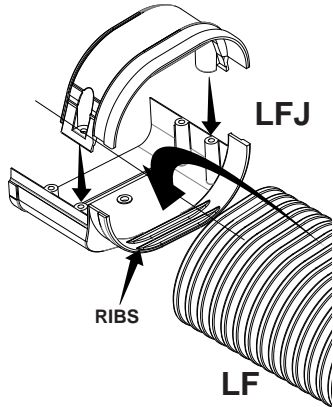

WALL CONNECTION

- (1) Seal and attach wall flange to wall.
- (2) Place LF duct into fitting.
- (3) Clamp LF duct with cap and two screws.

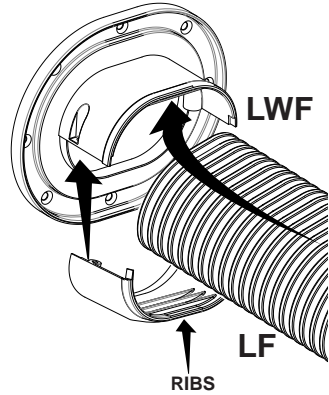

End fitting

End fitting provides critical support to the lineset duct cover. Without this fitting, the duct cover can slide out of place.

To adjust the opening to suit lineset size, simply snip the end fitting along the desired groove, and break off unwanted sections.

A coupling can also be utilized at the duct end for larger lineset fill.

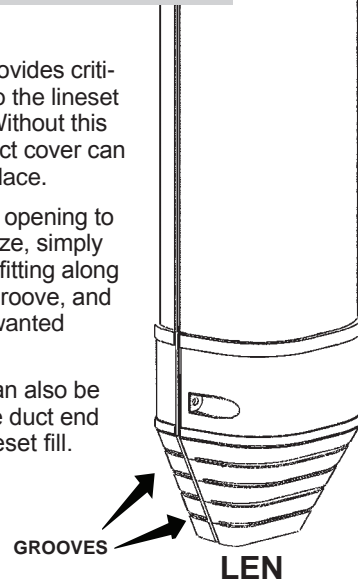

Wall Sleeve

- (1) Using a hole saw, drill a hole at the desired point of penetration.
- (2) Secure LW base over hole.
- (3) Insert LWS sleeve into hole.
- (4) Install lineset.
- (5) Seal and attach LW cover.

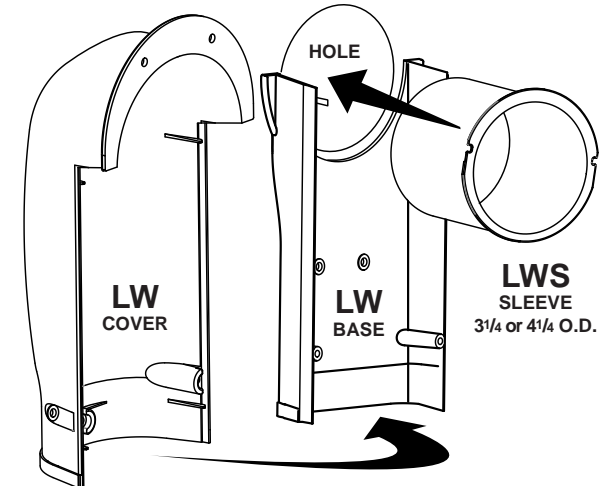

Fitting List

Available in WHITE, IVORY, BROWN and GRAY. Sizes 3 1/2" (92mm) or 4 1/2" (122mm).

	Ducting (8ft lengths)	LD		90° Inside Vertical EII	LCI		Flexible EII	LF
	Coupler	LJ		90° Outside Vertical EII	LCO		Flexible Adaptor	LFJ
	Wall Inlet	LW		45° Inside Vertical EII	LCFI		Flexible Wall Flange	LWF
	Soffit Inlet	LP		45° Outside Vertical EII	LCFO		Wall Sleeve	LWS
	End Fitting	LEN		Tee	LT		Twistlock Lineset clips	LDC
	90° Flat EII	LK		Reducer	LDR			
	45° Flat EII	LKF		90° Sweep EII	LKS			

Limited Warranty and Limitation of Liability

Airtec Products Corporation warrants to the original consumer purchaser of its products, that they are free from defects in material or workmanship. If within one year of purchase, this product shall prove to be defective, it shall be repaired or replaced at Airtec's option, subject to the terms and conditions set forth below. Your original receipt of purchase is a requirement to determine warranty eligibility. The limitations of liability set forth include body and all component parts as well as product itself as a whole.

Any purchaser or third party actions brought for any reason hereunder shall be brought in its entirety in Bristol County and no other jurisdiction, and such actions shall be subject to the laws of the State of Massachusetts. Any notice herein shall be sent to Airtec Products Corp., by certified or registered mail at 1244 Davol Street, Fall River, MA 02720.

General Terms and Conditions:

Purchaser must pay all labor and shipping charges necessary to replace product covered by this warranty. This warranty shall not apply to products which, in the sole judgment of Airtec, have been subject to negligence, abuse, accident, tampering, misapplication, alteration, nor due to improper installation, operation or maintenance or storage; nor to other than normal application, use or service, including but not limited to, operational failures cause by corrosion, rust or other foreign materials in the system. Requests for service under this warranty shall be made by returning the defective product to the Retail outlet or to Airtec as soon as possible after the discovery of any alleged defect. Airtec will subsequently take corrective action as promptly as is reasonable. This warranty sets forth Airtec's sole obligation and the purchaser's exclusive remedy for defective products. In all circumstances, Airtec's maximum liability shall not exceed the actual purchase price paid for the product alone. Warranty claims must be registered with Airtec within (30) days of damage or malfunction. Airtec reserves the right to visit the site of the installation or to require documentation of the claim before assuming any responsibility under the provisions of this warranty. Consumer agrees to inspect the product at the time of installation for any reasonable discernable defects and, further, agrees to inspect the product annually. Any damages occurring, which could have been avoided by proper inspection will not be the responsibility of Airtec. AIRTEC SHALL NOT BE LIABLE FOR ANY CONSEQUENTIAL, INCIDENTAL, OR CONTINGENT DAMAGES WHATSOEVER TO THE PURCHASER OR ANY THIRD PARTY. THE FORGOING WARRANTIES ARE EXCLUSIVE AND IN LIEU OF ALL EXPRESS WARRANTIES, IMPLIED WARRANTIES, INCLUDING BUT NOT LIMITED TO THE IMPLIED WARRANTIES OF MERCHANTABILITY AND FITNESS FOR A PARTICULAR PURPOSE, SHALL NOT EXTEND BEYOND THE DURATION OF THE APPLICABLE EXPRESS WARRANTIES PROVIDED HEREIN. Some states do not allow the exclusion of limitation of incidental and consequential damages or limitations on how long and implied warranty lasts, so the above limitations or exclusions may not apply to you. This warranty gives you specific legal rights and you may also have other legal rights that vary from state to state.