

Date: _____ Location: _____
 Product: _____ Project: _____
 Quantity: _____ Catalog #: _____

LED LOC-SL Multi Watt Multi CCT Strip Light with Emergency Battery and Motion Sensor



FEATURES

- Default Wattage is the highest wattage:
 - 4 Foot – 44W
- Default CCT: 5,000K
- IP20 rated
- Linkable design (see page 2 for details)
- 50,000 hours lifetime

SUITABLE APPLICATIONS

- Stairwells
- Warehouses
- Stadiums
- Factories
- Parking Lots
- Shopping Malls
- Supermarkets
- Logistic Centers
- Auto dealerships

CONSTRUCTION:

22-gauge metal housing with matte white paint. PMMA cover lens. Frosted lens. PC endcaps, quick-connector adaptor for continuous-run mounting.

OPTICAL SYSTEM:

Seoul 2835 LED chips. High quality tempered glass optics. 120° beam angle.

WARRANTY:

5-year limited warranty. Actual performance may differ as a result of end-user environment and application.

ELECTRICAL:

Available as 120-277V input. -20°C to 50°C, -4°F to 122°F

INSTALLATION & MOUNTING:

Hanging chain, surface mount or J-adaptor. These can link together. See above features for how many.

CONTROLS & DIMMING:

0-10V dimming comes standard.



MODEL NUMBER – 3,500K 4,000K 5,000K	WATTAGE	LUMENS	EFFICACY	CRI	POWER FACTOR	THD	REPLACES
LOC-4FTSL-MW(22/28/36/44)MCCT(35/40/50)DF-EM-MS	22W	2,862.2LM	130.1LM/W	80	0.9	20%	2 pieces 17W T8 lamp or 2 pieces 32W T8 lamp
LOC-4FTSL-MW(22/28/36/44)MCCT(35/40/50)DF-EM-MS	28W	3,642.8LM	130.1LM/W	80	0.9	20%	2 pieces 17W T8 lamp or 2 pieces 32W T8 lamp
LOC-4FTSL-MW(22/28/36/44)MCCT(35/40/50)DF-EM-MS	36W	4,683.6LM	130.1LM/W	80	0.9	20%	2 pieces 17W T8 lamp or 2 pieces 32W T8 lamp
LOC-4FTSL-MW(22/28/36/44)MCCT(35/40/50)DF-EM-MS	44W	5,726.9LM	129.77LMW	84	0.9739	6.82%	2 pieces 17W T8 lamp or 2 pieces 32W T8 lamp

DLC Product ID:

- LOC-4FTSL-MW(22/28/36/44)MCCT(35/40/50)DF-EM-MS – PL68JNBA9PJ5



Series	Size	4FT Wattage	Color Temperature	Dimming	Material	Accessory
LOC-SL	4FT = 4 foot	22W 28W 36W 44W	3500K 4000K 5000K	Dimmable	F = Frosted Lens	EM = emergency backup MS = motion sensor

MEASUREMENTS

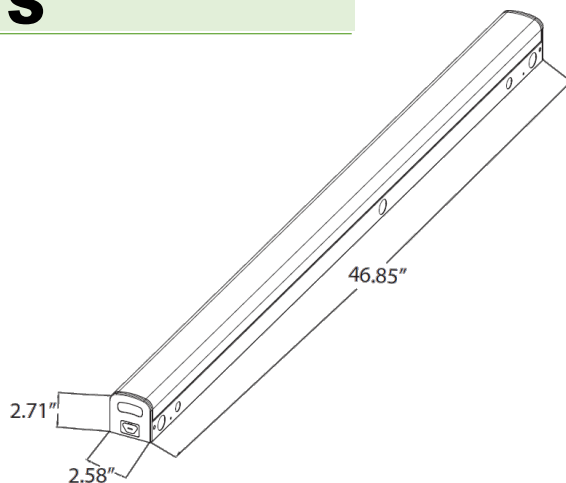

MODEL	QUANTITY	WEIGHT	UPC CODE
LOC-4FTSL-MW(22/28/36/44)MCCT(35/40/50)DF-EM-MS	1	lbs	00810050941624

LINKING TOGETHER

Model Number	Voltage (18AWG)	Linkable Qty	Voltage (16AWG)	Linkable Qty
LOC-4FTSL-MW(22/28/36/44)MCCT(35/40/50)DF-EM-MS	120V	20	120V	30
	240V	40	240V	65
	277V	50	277V	75

Emergency Battery



Emergency Test Button



Motion Sensor



OPTIONAL MOUNTING & ACCESSORIES

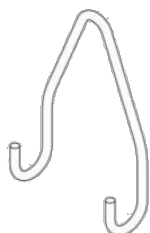

V-Hook (included)



Aircraft Cable

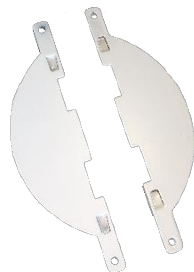

J-Box Cover (included)

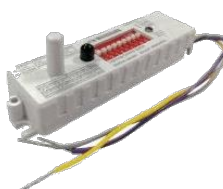

HB001 VCR 1



Remote Control
LOC-GDHB-HD05R

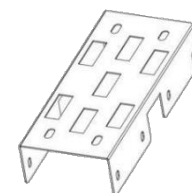

Bracket for linking
together (included)

4FT 22W

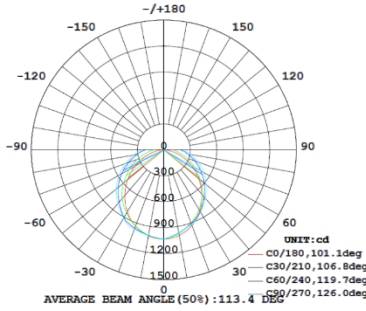

3,500K

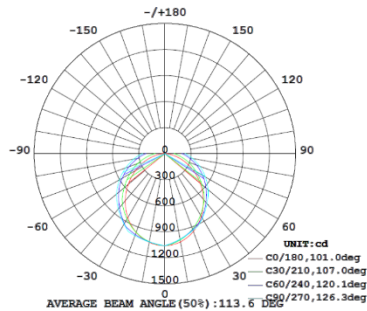

4,000K

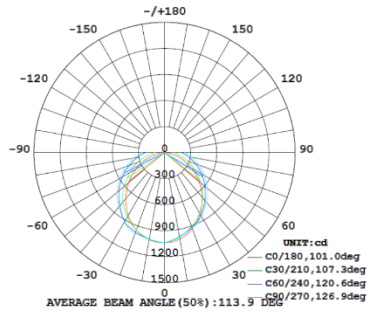

5,000K

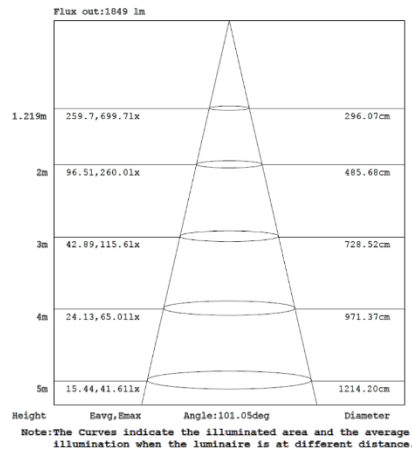
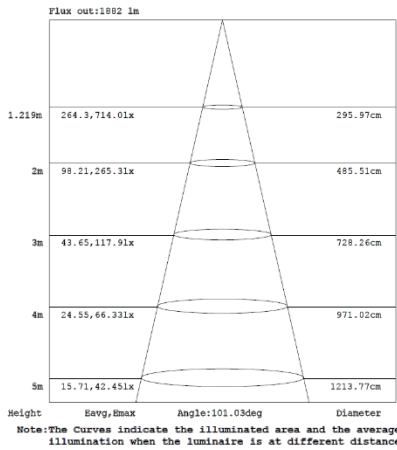
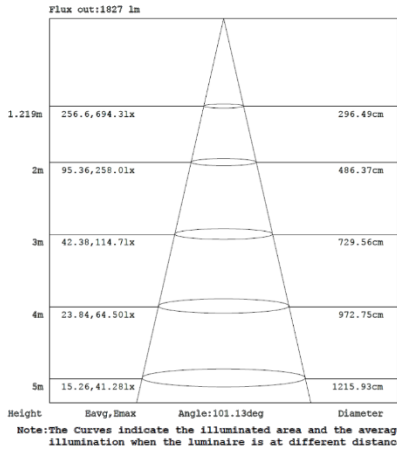

4FT 28W

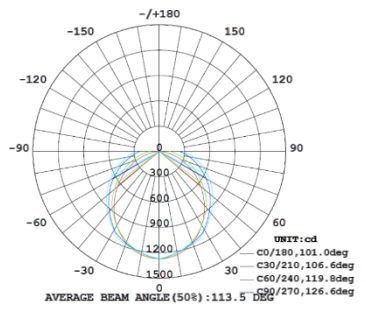

3,500K

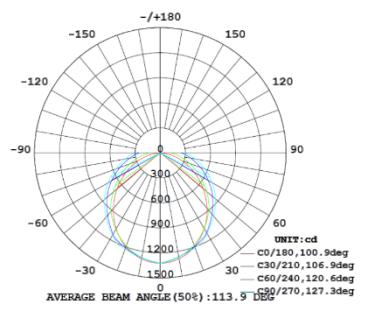

4,000K

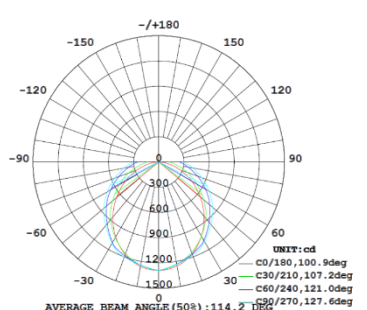

5,000K

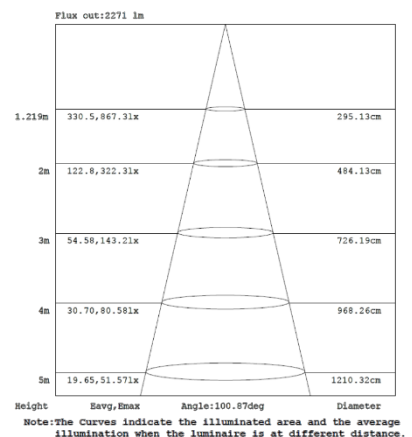
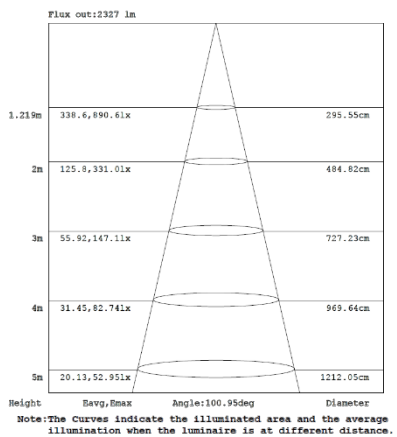
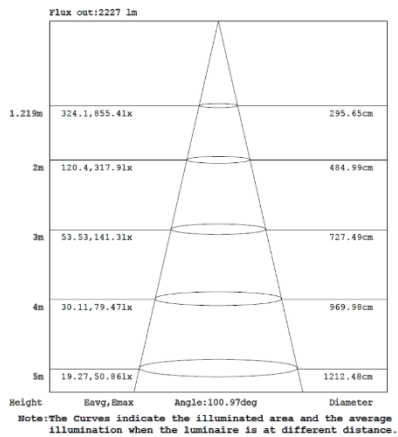

PHOTOMETRIC DATA

4FT 36W

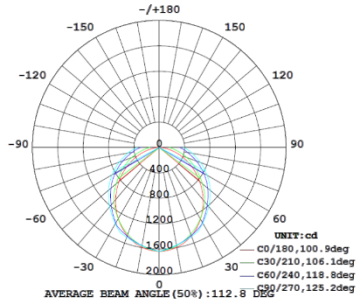

3,500K

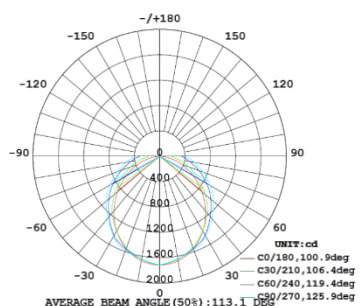

4,000K

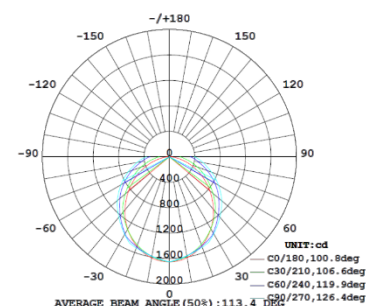

5,000K

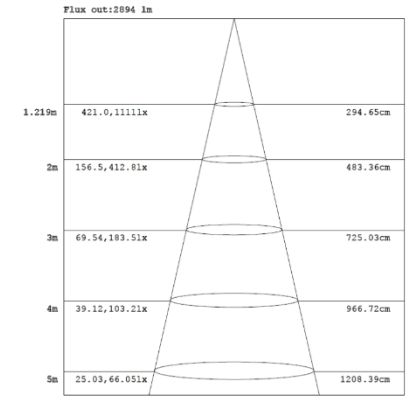
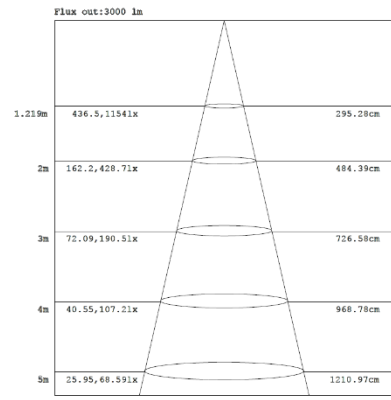
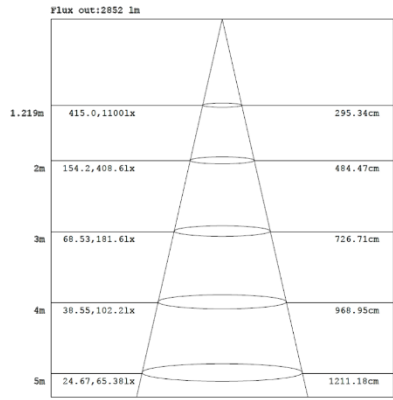

4FT 44W

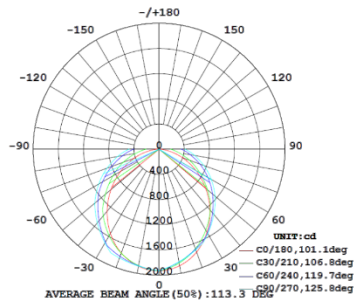

3,500K

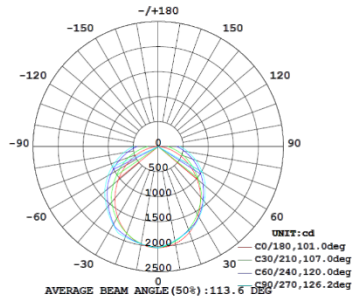

4,000K

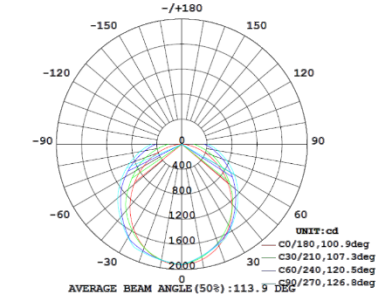

5,000K

