

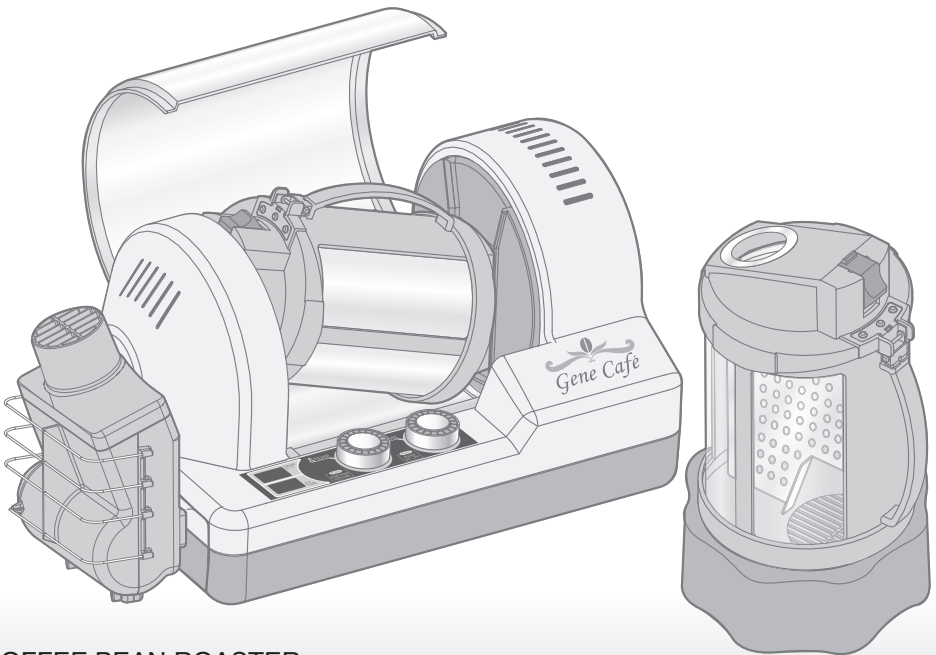

Gene Café

Owner's Manual
(Rev. 03)



COFFEE BEAN ROASTER
MODEL CBR-101
INNOVATIVE OFF - AXIS ROTATION

- To ensure Safety, trouble-free operation, please carefully read this manual
- Do not discard.





When using electrical appliances, basic safety precautions should always be followed, including the follow;

Warning!

**DO NOT LEAVE THIS OR ANY ROASTER UNATTENDED AT ANY TIME!
DO NOT PRE-HEAT THE ROASTER WITHOUT THE ROAST CHAMBER IN PLACE.**

1. Read all instructions.
2. Do not touch hot surfaces. Do not touch moving parts when machine is operating.
3. Roaster will stop automatically if system detects a problem or burnt chaff.
4. Use this roaster in a well-ventilated room, preferably under an exhaust hood.
5. To protect against risk of electrical shock, do not immerse this roaster, including the plug and cord, in water or any other liquid.
6. Always unplug the roaster from its electrical supply when not in use. Allow to cool completely before moving, storing or cleaning this roaster.
7. Do not operate roaster if it has been dropped or damaged in any manner or if roaster is malfunctioning. Return roaster to the nearest authorized service facility for examination, repair or adjustment.
8. Do not attempt to use any items which able to give harm and damage to the Gene Cafe Roaster!
9. Do not let cord touch hot surfaces or hang over the edge of the counter or table.
10. Do not place roaster on or near a hot gas or electric burner or in a heated oven.



11. Do not use outdoors.
12. Do not use roaster for any purpose other than roasting coffee beans.
13. Overfilling the roaster, inserting utensils, aluminum foil or metal packages may create a risk of fire or electrical shock.
14. Do not operate roaster close to curtains, draperies, walls or other flammable materials.
15. This roaster has a polarized plug (one blade is wider than the other). To reduce risk of electric shock, this plug should be into polarized outlet. If plug will not go into the outlet, reverse the plug. If the plug still does not fit, contact a qualified electrician. Do not attempt to modify the plug in any way.
(This article is for the roaster at 100V range, not 200V range)
16. Do not attempt to dislodge trapped beans when roaster is plugged in.
17. **Do not operate roaster unattended.**
18. **Keep pets & kids away from roaster when it is in operation.**
19. Never operate the roaster without the roasting chamber in place.



- Before using this roaster, please read the cautions carefully.
- This manual also contains warranty information. Please keep this owner's manual in a safe place.

1. Important Safeguards	1
2. Table of Contents	2-3
3. Introduction	4
4. Features	5
5. Configuration	6
6. Safety Precautions	7-9
7. Parts Name & Functions	7-11
8. Operation	12-16
1) Before Roasting	12
2) Power Supply and Timer Settings	14
3) Temperature Setting and Roasting	14
4) Cooling Start/Stop	15
5) Finishing the Roast	16
9. Cleaning & Maintenance	17
10. Roasting Guide	18
11. Troubleshooting	19
12. Error Messages and Emergent Measures	20
13. Notes	21-22
14. Warranty and Purchase Record	Back Cover



Thank you for purchasing the Gene Café CBR-101 coffee bean roaster.

The Gene Café CBR-101 is designed to be used as for a household coffee roaster. It incorporates state-of-the-art design, the highest quality materials and expert workmanship. Genesis Technology simplifies and automates the coffee roasting process.

Before using the Gene Café, read this manual carefully to learn how to use and maintain your roaster.

Specifications		
Name/Model	Gene Café CBR-101	
Mixing type	Vortex twisting (Off-axis rotation)	
Cooling	Ambient temperature forced ventilation (approx. 8 minutes)	
Heating	Indirect hot air (0~30 minutes)	
Temperature Control	0°F - 482°F / 0°C - 250°C	
Heater	1,300 Watts	
Power Supply	110V, 120V, 220V, 230V, 240V - 50/60Hz	
Power Consumption	1,300 Watts	
Chamber	Material	Heat resistant tempered glass tube (Pyrex®)
	Capacity	Max. 0.5LBs / 250g
Noise	65 dB	
Dimensions	19"x10"x9" / 490mm x 243mm x 229mm (Chaff Collector included)	
Net Weight	12.13 Lbs/5.5 kg	
Color	Black, Red	

Design and specifications subject to change without notice.
"Pyrex®" is a registered trademark of Corning Incorporated



6. Safety Precautions

* Please read the following information carefully before use.

Always follow safety precautions when operating your Gene Café roaster. Keep these very important cautions. Incorrect use of an electrical roaster may result in risk of electric shock or serious injuries as well as damage to the roaster.



Warning : It causes serious injuries unless reading these instructions carefully.

Warning

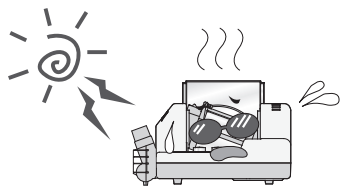

*To prevent damage, never use or store the Gene Café where it will be exposed to direct sunlight or other heating sources.

Warning

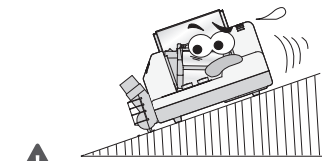

* Always use the Gene Café roaster on a level and stable surface.

Warning

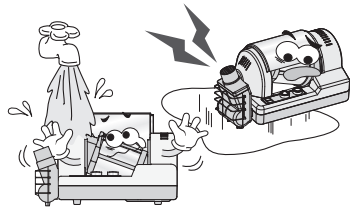

*Do not immerse the Gene Café in water and do not allow water or cleaning liquids to enter the roaster. Water and other liquids may create a safety hazard or damage the roaster.

Warning

* Do not operate Gene Cafe in wet places. It causes electric shock and damages.

* If water should penetrate into the Gene Café, disconnect it from the power supply and contact Customer Service.

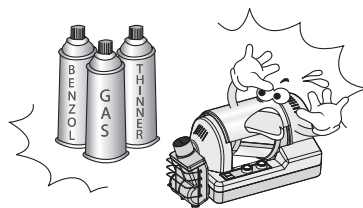

* Never operate the Gene Café near flammable substances such as oil, alcohol, benzene, gasoline or paint thinner.

Warning

* Do not use the Gene Café in a dusty environment or near flammable materials.

6. Safety Precautions

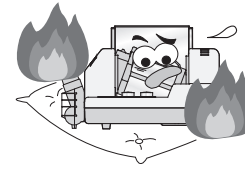

* Do not place Gene Café on a pad, cushion or electric blanket as a fire may result.

Warning

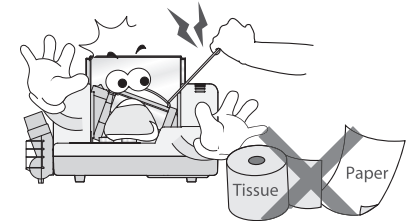

* Do not insert foreign objects, especially metal, into the Gene Café as it may cause deadly damages.

Warning

* Do not block Air-intake and Chaff Collector. It causes overheating and occurs fire.

* If a foreign object accidentally enters the Gene Café, immediately unplug the roaster. Do not attempt to disassemble Gene Cafe Roaster. Please contact the local seller(Distributor) !

* Unplug the power cord in case of emergency.

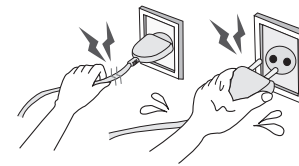

* To prevent short circuit, do not bend or force the power plug and do not tie the cord or disconnect the roaster from the wall outlet by pulling on the cord.

Warning

* Keep your hands dry always before operating the Gene Cafe.

* Disconnect the power plug when not using it.

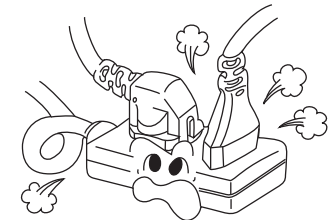

* You should insert the plug to the socket correctly. Otherwise it causes fire or short circuit troubles.

Warning

* If an extension cord must be used, be sure that it is a heavy-duty type with a rating at least equal to the power rating of the Gene Café.

* Please handle Power Plug gently !

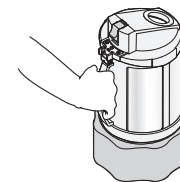

* Whenever the roasting chamber is not mounted in the Gene Café, place it in the chamber stand to reduce risk of tipping and breaking.

Warning

* The roasting chamber is not designed to stand upright without the aid of the chamber stand.



6. Safety Precautions

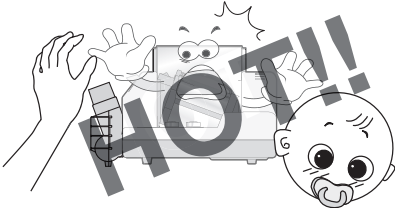

Warning * Please close the Safety Cover when operating Gene Cafe.
Keep the Gene Cafe away from the children and pets.

* Do not touch the roaster during operation.

* Please check and clean the chaff collector if you may not able to touch the surface by terribly hot.

* Do not preheat this product without coffee beans !

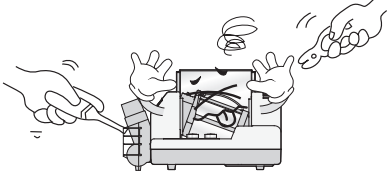

Warning * Please read Trouble Shooting Guide of this manual in cases of any malfunctions(Page 19~20).

* Do not attempt to disassemble the Gene Cafe Roaster on this kind of symptom.

* Please contact the seller for Customer Service.

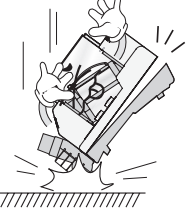

Warning * To prevent damage or safety issues, do not apply excessive pressure to the Gene Café or drop the roaster.

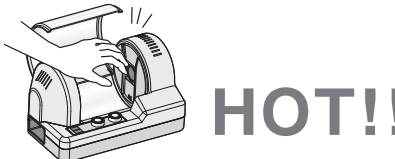

Warning * Please take a break to cool down the Gene Cafe if it is very hot to touch it.



NOTE !

Warning * Do not remove the blade ass'y of the separator ass'y. It causes the chamber glass broken without blade ass'y.



7. Parts Name & Functions

Main Body

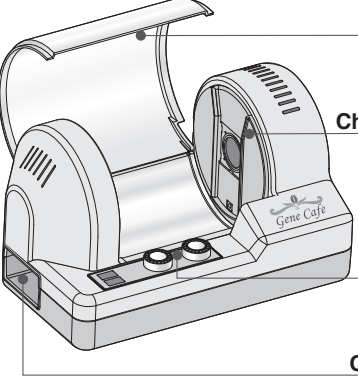

Safety Cover The Safety Cover can protect against burns and accidents. Please keep closing the safety cover.

Chamber Attachment The chamber meets this attachment area.

Control Panel Easy control to adjust Time & Temperature by Dial buttons.

Chaff Collector Port The chaff collector shall be assembled into this port.

Chaff Collector

Chaff Collector You may see the chaffs and coffee dusts on starting coffee roast. The Chaff Collector collects chaffs and dusts which shall be left in this collector and then smoke may go flying away.

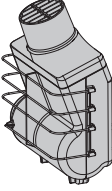
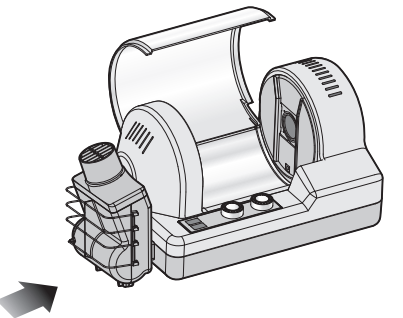
CHAFF COLLECTOR	ASSEMBLY
	



7. Parts Name & Functions

Chamber

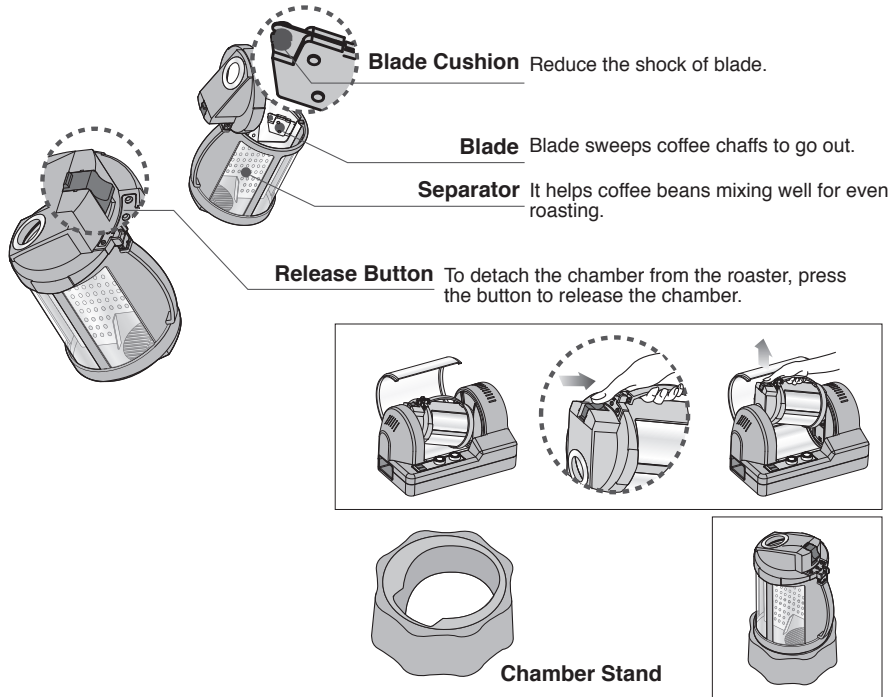

Control Panel

* For details about operations, refer to pages 14-15 in this manual.

Temperature (Start/Stop)

- (1) Roasting Temperature Control : Turn Right / Left (Up / Down)
- (2) Cooling Time : Press down this dial.
- (3) Emergency Stop : Keep pressing this dial for 3seconds. (You can use this function whenever you want to stop roasting immediately)

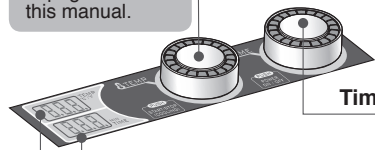

Timer (Power On/Off)

- (1) Roasting Time Control : Turn Right / Left (Up / Down)
- (2) Power On / Off : Press this dial.

Time Display

Temperature Display

8. Operation



Before Roasting 1

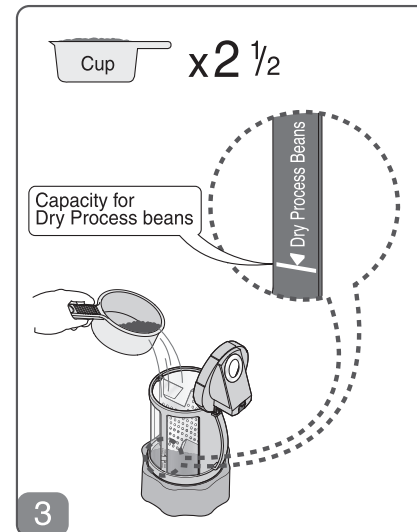
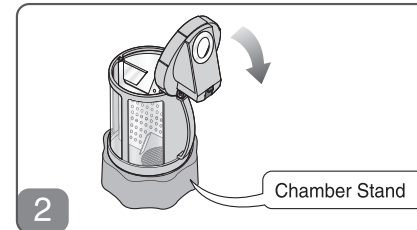
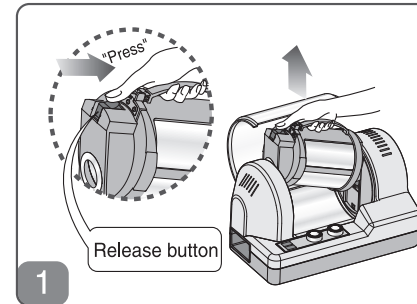

1. Open the safety cover, lift the chamber for coffee roast.

2. Gently place the roasting chamber on the chamber stand and open the lid.



* Please use the chamber stand for glass damages.

* Please be careful if you need to take the separator out by hands. (The Separator is sharp.)

3. Put the green beans.
One Full cup is 3.5oz(100g).

Do not exceed over the line indicates "Capacity for Dry Process Beans".



* Natural or Sun Dried Coffee beans have much more chaffs especially. Much amount of chaffs is hard to go out easily and it causes potential burn or fires.

* Do not put green beans more than 8oz(200g) such as Dry Processed or Peaberry Coffee Beans.

* Roasting coffee beans containing impurities or debris may cause a fire. Sort through the beans and remove any foreign material before placing beans in roaster.



8. Operation

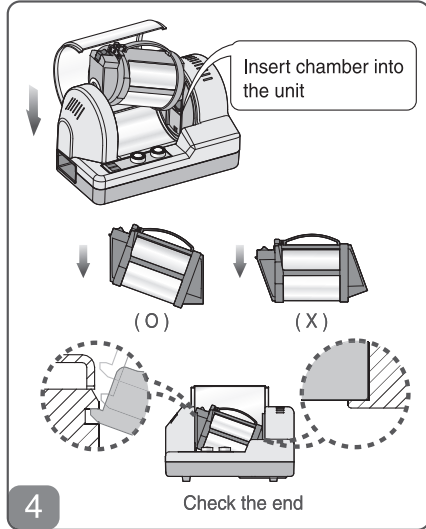

4. Insert the chamber gently into the main body as the left picture.

Warning * When installing the roasting chamber and body, make sure that the chamber cover faces to the left.

* Please check to see if the chamber is mounted in the middle of the roaster. Otherwise the chamber would not be rotated properly.

5. To ensure safe operation, close the safety cover and attach the chaff collector to the left side of the roaster before starting the machine.

Warning * Do not open the safety cover during roasting time.

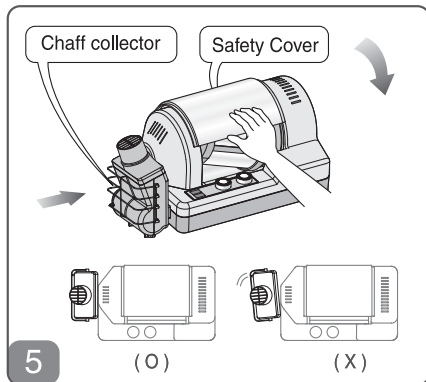

* **Do Not Operate the Gene Café without the chamber.**

* The Gene Café body and surrounding area becomes very hot when the roaster is in operation. **DO NOT LEAVE THIS OR ANY ROASTER UNATTENDED AT ANY TIME!**

* Please clean coffee chaff from the chaff collector before operating it.

Be careful of the hot surface.

Warning * Make sure that you should read this manual until you thoroughly understand operations and cautions.

- (1) Keep the chaff collector and metal filter(Bottom of the roaster) clean.
- (2) Keep any foreign objects away from the chamber and drum area.
- (3) Do not disturb the chamber rotation by any objects. It may cause some troubles on chamber rotation.
- (4) Operate the Gene Café at the flat place. We recommend that you use Gene Café under ventilation system.
- (5) Keep flammable agent away from the Gene Café.
- (6) Please operate the roaster near to the Fire Extinguisher.

8. Operation



Power Supply and Timer Setting 2

1. Insert the plug in the power supply as the left photo. Do not operate it with different power supply and different electric voltage. It may cause terribly troubles.



2. Power On/Off : Press the dial(blue) to turn on

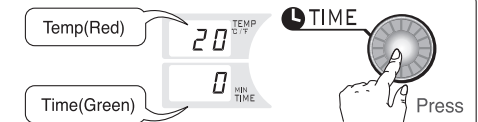

3. Time Control : Turn Left / Right (Time Adjustment)
- You can check the recommended roasting guide on page 14.
- Adjust Range is 0 ~ 30min.

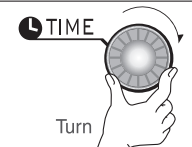

Temperature Setting and Roasting 3

1. Temperature (START/STOP) Control : Turn Left / Right (Temperature Adjustment)
- You can check the recommended roasting guide on page 14.
- Adjust Range is 482°F/0 - 250°C.

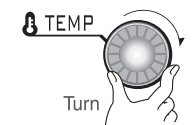

2. Start : Press the dial(Red) for adjusting temperature.

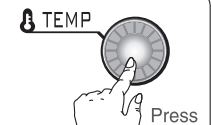

3. Time/Temp are always available during roasting time if necessary.

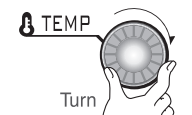



4 Cooling Start/Stop

1. If the roasting time is finished, the Cooling starts automatically.
You may listen Beep sound when the cooling finishes.
(Mostly the chamber temperature reaches at 140°F/60°C.)

2. Start Cooling :

Press the dial "TEMP" during roasting time.
The cooling cycle will stop on reaching at 140°F/60°C, regardless of remaining the roasting time.

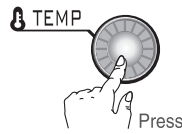

3. Stop Cooling during cooling cycle :

Press the dial "TEMP" again during the cooling cycle.

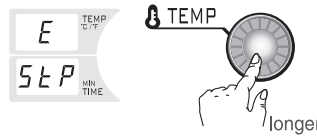

4. Stop Cooling during cooling cycle :

Press the dial "TEMP" again during the cooling cycle.

* Please take a break after operating it at few batches of roast.

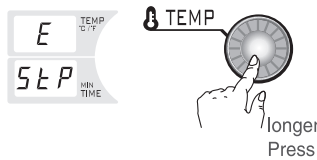

5. Continuous Roasting :

You can keep roasting coffee beans continuously by following and repeating the operational steps after finishing 1st batch of roast.

* This continuous roasting is usually designed for Coffee Shops or Restaurants.

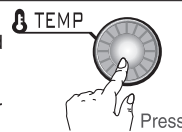

LED Display

Triple Digit
Double Digit
Single Digit

Temperature display alternately shows the current roasting temperature for two seconds, and then displays the set temperature for one second. This cycle repeats for the duration of the process.

Time display shows the time remaining during the roasting cycle, and the elapsed time, starting at zero, for the cooling cycle.

seconds
last digits in minutes
first digits in minutes

Set the timer at interval of six seconds.



Roasting finishes 5

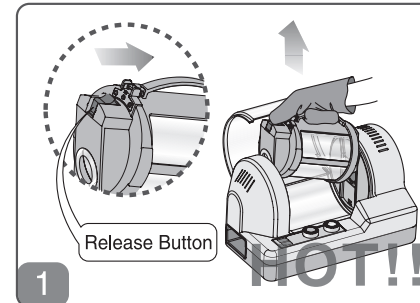

1. If the cooling is finished, the chamber will stop with beep sound.
Open the safety cover and take the chamber out to cool down.

Warning * Please wear oven mitts or gloves to handle the chamber.
Be careful of the chamber is very hot!



2. Open the chamber lid and pour the roasted beans.
Spread the beans evenly for cooling quickly.
We recommend that you use electric cooler or similar cooling fan.

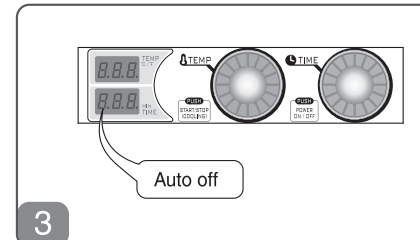

3. Automatically the Gene Cafe will be powered off with beep sound in one minute after the roasting is finished.

Warning * When installing the roasting chamber and body, make sure that the chamber cover faces to the left.

* Please check to see if the chamber is mounted in the middle of the roaster.
Otherwise the chamber would not be rotated properly.

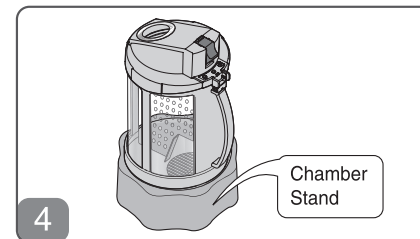

4. It is recommended for the users to clean the chamber periodically on the page 18th.



9. Cleaning & Maintenance

Roasting Chamber

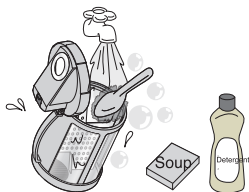

Oils and residual debris remaining from the roasting process will build up and adversely affect the taste of future batches. Clean the chamber using a dish washing brush, sponge and dish washing liquid. Dry the chamber completely before storing it away.

Warning *Wear the glove to prevent the damage.
*Be Careful of cleaning the separator and blade assembly.

Chaff Collector

Please clean the chamber periodically as the below instructions. Stacked chaffs have coffee oil and block the small holes inside of the chamber. If smoke is not going outside by stacked chaffs, you may be troubled of potential fire or too much smoke from inside. Remember to clean the mesh plate of the chaff collector after every 5 batches.

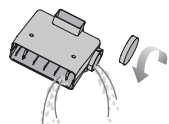

Please wear proper gloves on cleaning.

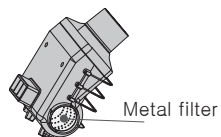

Clean the metal filter with a soft brush.

Warning Use a dishwashing brush to clean the outside metal filter and inside screens on the chaff collector

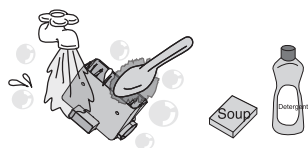

After cleaning, make sure to dry completely.

Warning When cleaning the Gene Cafe, be aware of sharp edges that may cause a cut.

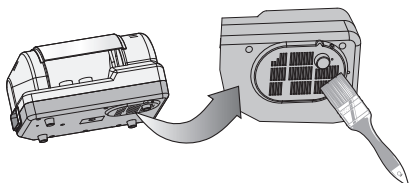

Remember to clean the mesh net at the bottom of the unit after every 10 batches.

Warning When cleaning the Gene Cafe, be aware of sharp edges that may cause a cut.

10. ROASTING GUIDE



About Coffee Roasting

Green unroasted beans have a very grassy fragrance and are essentially devoid of the flavor that we associate with coffee. Green coffee beans can last for several years when stored in a cool, dry place. Roasting the beans for between 12 and 23 minutes at a temperature of 392° – 482°F (200° – 250°C), develops the characteristic flavors that we associate with brewed coffee. During the roasting process, several changes take place to create a familiar coffee taste. As the beans start to turn brown, water content drops from 10% to 1%; fat increases from 12% to 16%; sugar decreases from 10% to 2%; chlorogenic acid is reduced from 7% to 4.5% and trigonelin lowers from 1% to 0.5%. Caffeine, cellulose, pectin and ash remain unchanged but the physical volume of the bean increase from 1.5 to 2.0 times while the bean's weight drops by 20%. As roasting time is increased, acidity is reduced and bitter notes become more pronounced. There are eight levels of roasting characteristics commonly associated with coffee.

Roasting Levels*

Roasting Level	Approximate Time*	Actual Temperature	Characteristics
Light Roast	12 minutes	446°F (230°C)	Strong acid, yellowish-brown color. Slight grain smell. Weak flavor
Cinnamon Roast	13 minutes	455°F (235°C)	American style. Slightly acidic. Cinnamon color.
Medium Roast	14 minutes	455°F (240°C)	Acidic characteristics and sweet flavors. Nut-like color. American style.
High Roast	15 minutes	464°F (245°C)	Bitter notes more pronounced than acid. Good for iced coffee.
City Roast	17 minutes	482°F (250°C)	Standard well-balanced taste and flavor. New York City origin.
Full City Roast	19 minutes	482°F (250°C)	Bitter characteristic slightly more assertive than acidity. Good for iced coffee.
French Roast	21 minutes	482°F (250°C)	Pronounced bitter notes; rich unique taste. European style. Good for iced coffee.
Italian Roast	23 minutes	482°F (250°C)	Strong and bitter but not acidic. Almost black in color. Good for espresso or cappuccino.

*Times given for roasting stages may vary depending on the type of green beans being roasted, household voltage and other variables



11. Troubleshooting

This troubleshooting guide can be used to diagnose common issues. If your problem is not covered here or cannot be resolved, contact Customer Service.

Symptom	Causes	Actions	Remarks
Unit does not work.	<ol style="list-style-type: none"> Power Cable is not connected well. Blown fuse or tripped circuit breaker. 	<ol style="list-style-type: none"> Connect the power cable to the outlet. Replace fuse or reset circuit breaker. Please try another outlet on a different circuit. Review instruction manual for proper operating procedure. Press TEMP again. Set the timer. 	
Roast is not available. Temperature does not reach to the target TEMP.	<ol style="list-style-type: none"> Unit is connected to a circuit delivering less voltage than required. Coffee Beans is overfilled. Improper roast level settings (time and/or temperature). Chaff collector is clogged. Fan filter is blocked. Other electric machine is used with the same power supply. 	<ol style="list-style-type: none"> Check rated voltage. Try using another circuit. Follow instructions for maximum amount of green coffee beans. Check and adjust roasting temperature if necessary. Increase roasting time. Clean the fan intake ports on the top of the roaster using a vacuum cleaner fitted with a brush attachment. Turn off other electric device. 	
Excessive smoke generated during roasting process.	<ol style="list-style-type: none"> Chaff collector inside metal filter is clogged. Incorrect roasting temperature selected. Roasting chamber overfilled. 	<ol style="list-style-type: none"> Empty the chaff collector. Clean the metal filter with water. Check temperature and time settings to prevent over-roasting. Use correct amount of green coffee beans. 	Maximum roasting amount per patch is 0.5Lbs (250g).
Vents blocked.	<ol style="list-style-type: none"> Roasting chamber overfilled. Some green beans have much more chaffs than common ones. 	<ol style="list-style-type: none"> Use proper amount of green coffee beans. If green coffee beans have thick skin, roast in smaller quantities. 	
Hard to detach/remove the chamber	<ol style="list-style-type: none"> Release button not fully depressed. 	Fully depress release button while lifting roasting chamber out of the roaster.	
Unable the chamber to insert properly.	<ol style="list-style-type: none"> Roasting chamber is being incorrectly inserted into the body. 	<ol style="list-style-type: none"> Please check the chamber lid is closed correctly. Please check the chamber is aligned properly. 	
Operation (rotation) does not stop.	<ol style="list-style-type: none"> Unit is not cooling down. 	<ol style="list-style-type: none"> The Gene Cafe does not stop automatically until it reaches at safe temperature. Press the dial "TEMP" for stopping it manually when it reaches at 212°F(100°C) 	<p>Safe Temperature is 140° F (60°C).</p> <p>Intermediate safety stop temperature is 212°F (100°C).</p>

12. Error Messages and Emergent Measures



Error Messages & Description

Error Message	E1	E2	E3	E4
Remarks	Temperature sensor 1 error	Precaution for the fires	Irregular rotation. Reed sensor error.	Heater disconnection. Fan or temperature sensor 2 error.

* Contact the distributor at the back cover if you see any of these error messages.

Emergent Measures

In the event that the Gene Café is turned off by mistake.

Please turn it on again. You can take the chamber out or keep going coffee roast.

In the event that a power failure interrupts the roasting process.

Please separate the Gene Cafe from the power supply. The chamber could start burning and then could make fire in some cases.

1st) Do not try taking the chamber out forcibly. Please turn it on again.
Please separate the chamber when the chamber is stopped.

In case of a fire

Firstly please use the fire extinguisher.
The chamber is extremely hot and it may cause ignite the fire.
Then please follow the below steps.

Do not leave until you finish the fire completely.

* Fire in roasting chamber

- Press the dial "TEMP" to stop the chamber.
- Please wear gloves or oven mitts before touching the Gene Cafe.
Firstly remove the chamber from the main body.
Secondly pour inner burnt beans from the chamber.

* Fire in the chaff collector

Firstly cool the chaff collector down completely then remove it from the main body for cleaning.
Silver Skins and Chaffs of Coffee Beans shall be burnt out easily.



Purchase Record

Product Name : *Gene Café*
Model Name : CBR-101
Date of Purchase : (mm/dd/yyyy)
Customer name :
Dealer :

Gene Café

- Contact the seller(distributor) for warranty or customer service request.
- Keep this manual.
- Warranty Period: One year from the purchase date.

Manufactured by **Genesis**

ADD : ZIP(426-220), Ansan Tekom-Gil 43, Sasa-Dong, Sangnok-Gu Ansan Si,
Gyeonggi-Do, Korea
Tel : 82 (0)31 415 6191 Web : www.genecafe.com