

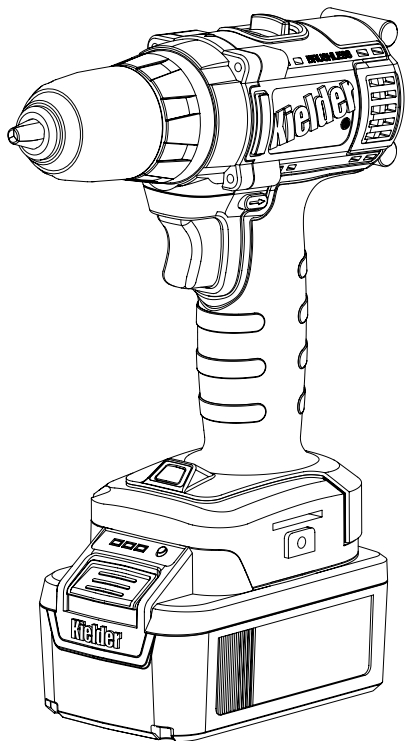

KWT-014



**Kielder**<sup>®</sup>  
18V CORDLESS COMBI DRILL

---

**ORIGINAL INSTRUCTION MANUAL**

For use with all variants of KWT-014 Cordless Combination Drill







## IMPORTANT!

Please read these operating and safety instructions carefully and completely. For your own safety, before using this equipment check that the voltage is correct and that all external parts are firmly secured and the machine in tact. If you are uncertain about any aspect of using this equipment, or require support please contact Kielder WT customer services and we'll be happy to help:

**Tel:** 0114 242 3794

**Email:** tools@kielder.co

### Intended Use

This tool can be used to tighten screws in screw mode, drill holes in wood & metal in drill mode and holes in masonry in hammer drill mode

### Plug Type

- The appliance is supplied with a moulded three pin mains plug for your safety and convenience.
- Only use this plug in the socket it is intended.
- A 3 amp fuse is fitted in this plug. Should the fuse need to be replaced please ensure that the replacement fuse has a 3 amp rating and it is approved by ASTA or BSI to BS1362.
- Check for the ASTA mark or the BSI mark on the fuse.
- If the plug contains a removable fuse cover, you must ensure that it is refitted when the fuse is replaced.
- If you lose the fuse cover the plug must not be used until a replacement cover is obtained.

### Contents

Safety Rules & Instruction	4
Product Overview Diagram	8
Specification Table	9
<b>Usage</b>	
<i>Combi Drill</i>	10
<i>Battery</i>	13
<i>Charger</i>	14
<i>Maintenance, LED Light &amp; Belt Clip</i>	16
<i>Warranty &amp; Support</i>	17

## EC - Declaration Of Conformity

We declare that under our responsibility the product under part number:

**KWT-014 18V Cordless Combi Drill** complies with the applicable EU directives:

2011/65/EU, 2004/108/EC, 2006/42/EC including the amendments and are manufactured in accordance following standards or standardised documents:

EN 60745-1:2009+A11

EN 60745-2-1:2010

EN 60745-2-2:2010

EN 55014-1:2006+A1:2009+A2:2011

EN 55014-2:1997+A1:2001+A2:2008

All documentation is held in KWT-014 Technical File and is available, on request for review.

Authorised Signatory:

Steven Bulloss

Director

Dated: 01/01/2020

Kielder WT Ltd, Unit 14 Carlisle Business Park,  
40 Chambers Lane, Sheffield S4 8DA

### Noise & Vibration Data

Acoustic Pressure: <81(A) K=3dB

Acoustic Power: <92dB(A) K=3dB

Maximum Vibration: <15.909m/s<sup>2</sup> / K = 1.5m/s<sup>2</sup>

Sound emission values determined according to EN60745-2-1. The declared vibration total value has been measured in accordance with a standard test method used to compare one tool with another and according to EN60745. Both sound and vibration values have an uncertainty factor of K. The declared total values may be used in a preliminary assessment of exposure.



## WARNING!

The vibration emission during actual use of the power tool can differ from the declared total value depending on the ways in which the tool is used. The need to identify safety measures and to protect the operator are based on an estimation of exposure in the actual conditions of use (taking account of all parts of the operating cycle, such as the times the tool is switched off, when it is running idle, in addition to trigger time). Identify additional safety measures to protect the operator such as proper maintenance of the tool, keeping hands warm and organisation of work patterns.



## WARNING!

This product uses Lithium Battery cells, do not use if the battery has been damaged in transit or becomes damaged during use. If Lithium-ion cells are damaged they present a flammable hazard.

### General Safety

**Warning:** When using electric tools, basic safety precautions should always be followed to reduce the risk of fire, electric shock and personal injury. Please read all of these instructions before attempting to operate this machine. Save this manual for future reference.

- Keep work area clear. Cluttered work areas invite accidents.
- Consider work area environment. Do not expose tools to rain. Do not use tools in damp or wet locations. Keep work area well lit. Never use tools near flammable liquids or gases.
- Protect yourself against electric shock. Avoid body contact with earthed or grounded surfaces.
- Keep other people away. Do not let others, especially children, come close to the work, and touch the tool or power cable. Keep them away from the work area.
- Store idle tools. When not in use, tools should be stored in a dry locked-up place, out of children's reach.
- Never force the tools. Your tools will be more efficient and safer when used at the rate for which they were intended.

### Personal Safety

- Stay alert, watch what you are doing and use common sense when operating a power tool. Do not use a power tool while you are tired or under the influence of drugs, alcohol or medication. A moment of inattention while operating power tools may result in serious personal injury.
- Use personal protective equipment. Always wear eye protection. Protective equipment such as dust mask, non-skid safety shoes, hard hat, hearing protection, anti-vibration gloves used for appropriate conditions will reduce personal injuries.
- Prevent unintentional starting. Ensure the switch is in the off-position before connecting to power source and/or battery pack, picking up or carrying the tool. Carrying power tools with your finger on the switch or energising power tools that have the switch on invites accidents.
- Remove any adjusting key or wrench before turning a power tool on. A wrench or a key left attached to a rotating part of the power tool may result in personal injury.
- Do not overreach. Keep proper footing and balance at all times. This enables better control of the power tool in unexpected situations.
- Dress properly. Do not wear loose clothing or jewellery. Keep your hair, clothing and gloves away from moving parts. Loose clothes, jewellery or long hair can be caught in moving parts.
- If devices are provided for the connection of dust extraction and collection facilities, ensure these are connected and properly used. Use of dust collection can reduce dust-related hazards.

## Safe Use Of Power Tools

Do not force the power tool. Use the correct power tool for your application. The correct tool will do the job better and safer at the rate for which it was designed.

- Do not use the power tool if the switch does not turn it on and off. Any power tool that cannot be controlled with the switch is dangerous and must be repaired.
- Disconnect the plug from the power source and/or the battery pack from the power tool before making any adjustments, changing accessories, or storing power tools. Such preventive safety measures reduce the risk of starting the power tool accidentally.
- Store idle power tools out of the reach of children and do not allow persons unfamiliar with the power tool or these instructions to operate the tool. Power tools are dangerous in the hands of untrained users.
- Maintain power tools. Check for misalignment or binding of moving parts, breakage of parts and any other condition that may affect the power tool's operation. If damaged, have the power tool repaired before use. Many accidents are caused by poorly maintained power tools.
- Keep cutting tools sharp and clean. Properly maintained cutting tools with sharp cutting edges are less likely to bind and are easier to control.
- Use the power tool, accessories and tool bits etc. in accordance with these instructions, taking into account the working conditions and the work to be performed. Use of the power tool for operations different from those intended could result in a hazardous situation.

## Battery & Charger

Recharge battery only with the charger specified by the manufacturer. A charger that is suitable for a certain type of battery pack may create a risk of fire when used with another battery pack.

- Use power tools only with specifically designated battery packs. Use of any other battery packs may create a risk of injury and fire.
- Keep battery pack and charger away from other metal objects, like paper clips, coins, keys, nails, screws or other small metal objects, that can make a connection from one terminal to another. Shorting the terminals together may cause burns or a fire.
- Under abusive conditions, liquid may be ejected from the battery; avoid contact. If contact accidentally occurs, flush with water. If liquid contacts eyes, additionally seek medical help. Liquid ejected from the battery may cause irritation or burns.

## Service

Have your power tool serviced or repaired by Kielder or a qualified technician using only identical replacement parts. This will ensure that the safety of the power tool is maintained.

## Additional Safety & Working Instructions



- Wear ear protectors. Exposure to noise can cause hearing loss.



- Wear eye protection to protect from loose particles which may be thrown up by the impact motion of the tool.



- Wear a dust mask if the work creates dust.

- Apply the power tool to the fastening only when it is switched off. Rotating tool inserts can slip.
- When storing or carrying the tool the Forward/Reverse lever should be set to the centre to lock the trigger and prevent the tool being started accidentally.
- Hold the machine with a firm grip. High reaction torque can occur while the tool is in drilling, or high torque driving mode.
- Secure the workpiece. A workpiece is held more securely in a vice than by hand.
- Always wait until the tool has stopped completely before setting it down.
- Hold the tool by the insulated gripping surface as the drill or driver bit may contact hidden wiring. Contact with a 'live' wire will make exposed metal parts of the tool 'live' and shock the operator.
- Be aware that this tool is always in an operating condition as it does not have to be plugged into an electrical socket.
- When drilling or driving into walls or floors, live electric wires may be encountered. **DO NOT TOUCH THE CHUCK OR ANY FRONT METAL PARTS OF THE DRILL.** Hold the tool only by the rubber handle to prevent an electric shock in case you drill into a live wire.
- If the bit becomes jammed, turn off the trigger switch to prevent an overload. This can damage the battery pack or motor. Use reverse motion to loosen jammed bits.
- **DO NOT** operate the Forward/Reverse lever when the trigger switch is on. The battery will discharge rapidly and may damage the tool.
- During charging the charger may become slightly warm. This is normal. **DO NOT** charge the battery for a long period.
- Do not strain the tool by holding the speed control trigger halfway so that the motor stops.
- Do not operate the speed selector switch (LOW/HIGH) while pulling the speed control trigger. This can cause the rechargeable battery to wear quickly or damage the mechanism of the motor.



## CAUTION!

This product is powered by a rechargeable battery system, please pay attention to these additional instructions:

- When the battery pack is not being used, the battery should be stored so that foreign substances like dust and water do not contaminate the terminals.
- When the battery pack is being charged, ensure that the terminals are free of dust and water. Clean the terminals before using the battery if any foreign substances are seen.
- The life of the battery pack may be adversely affected by dust or water during operation.
- If the motor or battery becomes hot, the protection function will activate and the motor or battery will stop operating.
- Before inserting the battery pack, always check to ensure that the tool is turned off.
- For safe use ensure that the battery pack is installed properly and securely to the main unit before operating.
- Do not use other than the Kielder battery packs that are designed for use with this rechargeable tool.
- Kielder is not responsible for any damage or accident caused by the use of recycled or counterfeit battery packs.



- Do not dispose of the battery pack in a fire or expose it to excessive heat.
- Do not attempt to dismantle or modify the battery pack.
- Do not subject the battery pack to shocks or drive nails or similar items into it.
- Do not allow metal objects to touch the terminals on the battery pack.
- Do not carry or store the battery pack in the same container as nails or small metal objects.



• Do not charge the battery pack in a high temperature location e.g. next to a fire or in direct sunlight. The battery may overheat, catch fire or explode.

- Do not use other than the dedicated charger to charge the battery pack as the battery may leak, overheat or explode.
- When removing the battery pack from the tool or the charger, always reattach the pack cover as the battery contacts could be shorted, leading to a risk of fire.
- When the battery pack has deteriorated replace it with a new one. Continued use of a damaged battery pack may result in heat generation, ignition or rupture of the battery.

### Collection And Disposal Of Old Equipment And Used Batteries:

These symbols on the products, packaging and accompanying documents mean that used electronic products and batteries should not be mixed with general household waste.



For proper treatment, recovery and recycling of old products and used batteries, please take them to applicable collection points, in accordance with the national legislation and the Directives 2002/96/EC and 2006/66/EC.

By disposing of these products and batteries correctly, you will help to save valuable resources and prevent any potential negative effects on human health and the environment which could otherwise arise from inappropriate waste handling.

For more information about collection and recycling of old products and batteries, please contact your local municipality, your waste disposal service or the point of sale where you purchased the items.

Penalties may apply for the incorrect disposal of waste in accordance with national legislation.

## PRODUCT OVERVIEW

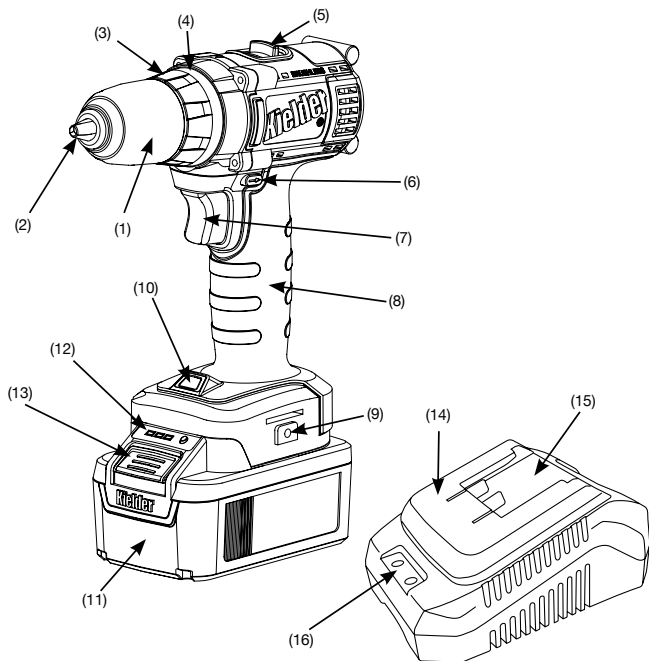

- |                                       |                                       |
|---------------------------------------|---------------------------------------|
| (1) Chuck Lock Collar Grip            | (9) Belt Clip Fitting                 |
| (2) Chuck Jaws                        | (10) LED Light                        |
| (3) Torque Selection Ring             | (11) Battery; <i>attached to tool</i> |
| (4) Function Selection Ring           | (12) Battery Charge Level Indicator   |
| (5) Speed Selection Switch            | (13) Battery Release Button           |
| (6) Forward / Reverse / Lock Selector | (14) Charger                          |
| (7) Trigger                           | (15) Battery Insert Slide             |
| (8) Hand Grip                         | (16) Charge Indicator                 |



# SPECIFICATIONS

## Main Unit

Model	KWT-014
Motor Voltage	18.0V - DC
Motor Type	Digital Brushless
Chuck Capacity / Type	13mm / Keyless 3 Jaw
Weight (with battery KWT-003-04 fitted)	1.4kg
Weight (without battery fitted)	1.1kg
No Load Speeds	0-400 min <sup>-1</sup> / 0-1600 min <sup>-1</sup>
Max Capacity Steel / Wood / Masonry	13mm / 38mm / 10mm
Max Torque	52Nm / 21 Positions + Drill + Hammer
Vibration: Driving / Drill / Hammer Drill*	<1.793m/s <sup>2</sup> / <2.371m/s <sup>2</sup> / <15.909m/s <sup>2</sup>
Battery Type	Lithium-ion

\*mean level during maximum capacity

## Battery Pack





Model	KWT-003-04 2.0AH (KWT-003-03 4.0Ah / KWT-003-25 5.0Ah: optional)
Cell Type	Lithium-ion
Battery Voltage	18.0V DC
Weight (KWT-003-04)	0.3Kg

## Battery Charger

Model	KWT-004
Ratings	See Rating Label on Base of Charger
Charge Time 2.0Ah (Useable charge from flat)	30 mins (KWT-003-04 / 2.0AH)
Charge Time 2.0Ah (Full charge from flat)	40 mins (KWT-003-04 / 2.0AH)
Weight	0.4Kg

Symbol	Meaning
V	Volts
===	Direct Current
min <sup>-1</sup>	Revolutions Per Minute
Ah	Electrical Capacity

	Read Instruction Manual Before Use
	Wear Hearing Protection
	Wear Safety Glasses
	Indoor Use Only

	Class II construction (double insulated)
	Conforms to CE standard
	Do not burn or incinerate
	Maximum safe ambient temperature for battery

## USAGE

### Fitting or Removing the Bit



### CAUTION!

When fitting or removing a bit, place the switch to the centre position (switch lock) or disconnect the battery pack from the tool.

This tool is equipped with a keyless drill chuck.

#### Attaching a Drill or Driver Bit

Insert the bit (A) into the centre of the 3 Jaws (B) in the chuck and turn the lock collar (C) clockwise (looking from the front), tighten firmly until the bit is fully secured by the jaws.

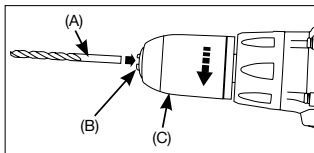

To optimise the grip from the chuck; the bit should be inserted well inside so the full length of the chuck jaws grip the shank (D), but without the end of the drill bit resting against chuck retaining screw (E).

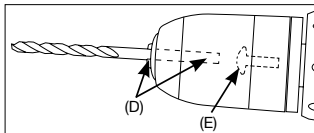

#### Removing a Drill or Driver Bit

Turn the lock collar (C) anticlockwise (looking from the front) then remove the bit (A).

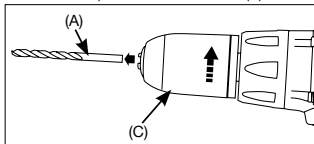

**Note:** If excessive play occurs in the chuck, secure the drill in place and open the chuck jaws and tighten the screw (E) with a screwdriver by turning it anticlockwise (looking from the front).

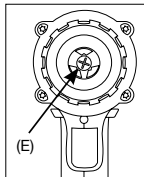

### Attaching or Removing the Battery Pack

#### Connect The Battery Pack:

Line up the alignment channels and slide on the battery pack.

Slide the battery pack until it locks into position with an audible "CLICK".

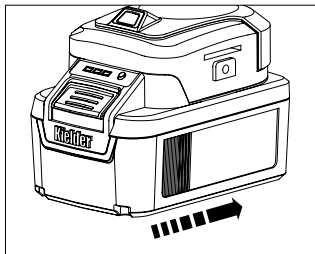

#### Remove The Battery Pack:

Depress the button (F) at the front of the battery indication panel and slide the battery pack out.

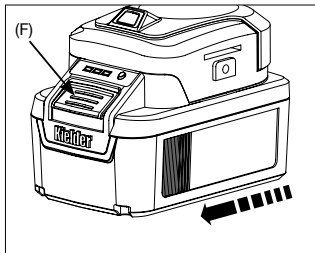

## Operating the Tool



### WARNING!

Do not operate the Forward/Reverse lever unless the tool is at a complete stop.

#### Forward Rotation (Clockwise)

- Push the lever into the forward rotation position (G).
- Depress the trigger (H) slowly to start the tool, check the direction of rotation is as required.
- The speed increases as the trigger is depressed further.
- The brake operates and tool stops immediately when the trigger is released.

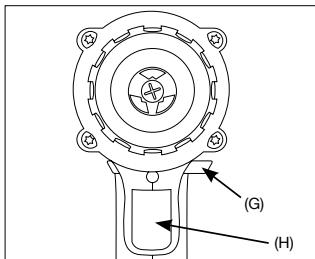

- After use, move the lever to the centre (I), this is the trigger lock position and how the tool should be stored.

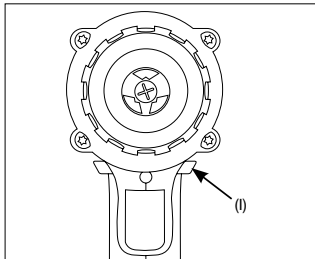

#### Reverse Rotation (Anti-Clockwise)

- Push the lever into the reverse rotation position (J).
- Depress the trigger (H) slowly to start the tool, checking the direction of rotation
- The speed increases as the trigger is depressed further.
- The brake operates and the socket stops immediately when the trigger is released.

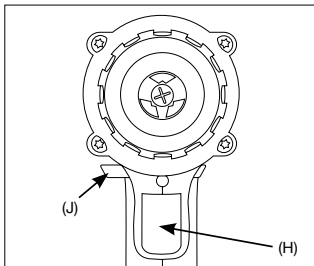

- After use, move the lever to the centre (I), this is the trigger lock position and how the tool should be stored.



### CAUTION!

Don't operate the tool continuously when switching battery packs. The tool requires time to cool down in between. In normal operating ambient temperatures this should take around 5 minutes, in hot working conditions allow a longer time for the tool to cool down.



**DO NOT** close up any of the vent holes on the sides of the main unit during operation. The machine function may be adversely affected.

**DO NOT** strain the motor as this may cause damage to the unit. When drilling allow the bit to do the work.

Ensure that the tool is used in such a way as to prevent the hot air from the vent holes being blown onto your skin as this may cause burns.

### Setting The Torque or Application

Engage the desired application by aligning the corresponding symbol on the function selection ring with the indicator arrow in the centre of the tool body (K).

Symbol	Function
	<b>Rotary-Drill Mode</b> Use for drilling applications in materials such as wood metal, or plastic.
	<b>Screw-Driving Mode</b> Adjust torque ring (L) to one of the 21 settings to limit the torque according to the fastening kind and/or material being screwed into. 1 is the lowest, 21 is the highest.
	<b>Hammer-Drill Mode</b> Masonry bits can be used to drill into concrete, brick or blockwork.
<b>NOTE:</b> If <b>Rotary-Drill Mode</b> or <b>Hammer-Drill Mode</b> is selected then the torque limiting clutch is 'locked' and full torque will be imparted.	

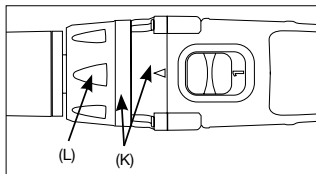

### Drill & Hammer-Drill Applications

Always allow the tool to do the work. When drilling masonry, using the hammer function; applying excess pressure to the rear of the tool actually slows down the drilling process. By only applying a modest amount of rear pressure to the tool, all internal components can operate freely and the hammer motion is more effectively transferred through the drill bit, thus speeding up how quickly a hole is drilled.



### CAUTION!

Check the gear selector switch before use. Use at low speed when high torque is required. (Using at high speed when high torque is needed may cause the motor to stall).

Do not operate the gear selector switch while the tool is running at full power. This may cause permanent damage to the tool and / or battery.

### Speed Selection

Slide the gear selection switch to choose a low (M) or high speed (N) to suit the work being undertaken. It is possible to fine tune either of the speed settings via the variable speed trigger, the more the trigger is depressed, the higher the speed.

When selecting a different speed it may be necessary to run the motor slowly, by partially depressing the trigger for the gears to properly align. Once the motor is slowly running apply pressure to the speed selector switch and the gear will engage.

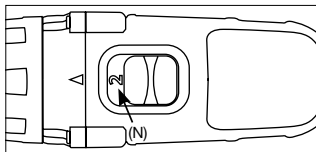
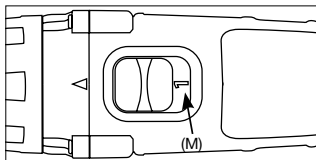



## CAUTION!

Don't operate the tool continuously when switching battery packs. The tool requires time to cool down in between. In normal operating ambient temperatures this should take around 5 minutes, in hot working conditions allow a longer time for the tool to cool down.

### Battery Level Indicator

• The Battery Level indicator is located on the front of the battery. To check the amount of power remaining, press and hold the small circular button (J) on the indication panel.

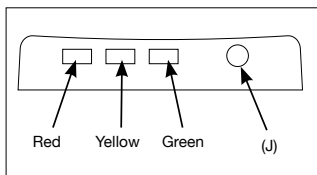

Take note of which of the three lights are illuminated.

**Red, Yellow & Green illuminated = High Charge**

**Red & Yellow illuminated = Medium/Low Charge**

**Red light illuminated = Low Charge/Empty**

If the battery is of low charge, it should be charged before further use.

The battery level indicator may be used with battery connected or disconnected to the tool.

• If the tool is started with little battery power remaining, it may stop operating after a short time. If this happens, check the battery power remaining by pressing the small circular button (J) on the indicator panel and charge the battery pack accordingly.

• Excessive discharging of lithium-ion batteries dramatically shortens their life. This tool includes a battery protection feature to prevent excessive discharging of the battery pack. If the tool is subject to a sudden load during use that causes the motor to lock, the over-discharge prevention sensor may trigger. If this happens, address the issue that caused the motor to lock and cycle the trigger.

#### NOTE:

The battery level indicator is a guide. The indication may change due to the condition of the battery or the ambient temperature.

## Battery Care

- If the tool is started with little battery power remaining, it may stop operating after a short time. If this happens charge the battery pack accordingly.
- Excessive discharging of lithium-ion batteries dramatically shortens their life. This tool includes a battery protection feature to prevent excessive discharging of the battery pack. If the tool is subject to a sudden load during use that causes the motor to lock, the over-discharge prevention sensor may trigger. If this happens, address the issue that caused the motor to lock and cycle the trigger.
- For optimum battery life, store the battery pack following use without charging it.
- Do not charge the battery pack when the temperature is below 0°C or above 40°C.
- When charging the battery pack ensure that the terminals on the battery charger are free of foreign objects such as dust and water. If any dirt is found on the terminals clean the terminals before charging the battery pack. The life of the battery pack terminals may also be affected by foreign objects during operation.
- Avoid storing the battery pack in a container with other metal objects such as nails, coins, etc. Metal objects can make a connection from one terminal to another and could short the battery terminals resulting in overheating and irreparable damage to the battery, sparks, burns or fire.
- Do not touch the terminals with any conductive material.
- When operating the battery pack, ensure that the work place is well ventilated.
- When the battery pack is removed from the main unit, store the battery in a location to prevent dust or dirt from contaminating the battery terminals which may cause a short circuit.

- Do not store the battery pack in locations where the temperature may reach or exceed 45°C
- Do not incinerate the battery pack even if it is severely damaged or is completely worn out. The battery pack can explode in a fire.
- Do not expose the battery pack to water or rain.
- Be careful not to drop, shake or strike the battery.

## Battery Pack Life

The rechargeable batteries have a limited life. If the operation time becomes short after recharging, replace the battery pack.



## ATTENTION! Battery Recycling

For environmental protection and recycling of materials, please ensure that the battery pack is disposed of at an officially assigned location

### Note:

The battery pack is not fully charged at the time of purchase. Be sure to charge the battery before use.

## Charging The Battery Pack

### CAUTION!



• The charger is designed to operate on standard domestic electrical power as shown on the rating plate. Charge only on the voltage indicated on the rating plate e.g. 230v/50Hz.

- Do not attempt to use it on any other voltage or frequency rating!
- If the temperature of the battery pack is extremely low, charging may automatically stop to prevent degradation of the battery.
- The ambient temperature range for charging is between 0°C and 40°C. The battery pack may not work if the temperature is outside these parameters.
- When charging a cool battery pack (below 0°C) in a warm place, leave the battery pack at the place and wait for more than one hour to warm up the battery to the ambient temperature.
- Allow the charger to cool in between charges, when charging more than two battery packs consecutively.
- Do not insert your fingers onto the contact area at any time.
- To prevent the risk of fire or damage to the battery charger, do not cover vent holes on the charger and the battery pack.
- Unplug the charger when not in use.
- Take care to ensure metal objects such as nails, coins etc are kept away from the charger. Metal objects can make a connection from one terminal to another and could short the charging unit.
- Ensure that the terminals on the charger are free of foreign objects such as dust and water. If any dirt is found on the terminals clean the terminals before charging the battery pack.

- When the charger is not in use, store in a location to prevent dust or dirt from contaminating the terminals which may cause a fault or short circuit.
- Position the charger on a work bench or similar in a well ventilated location and ensure that the charger cannot be covered by workshop cloths etc.
- Plug the charger into a suitable power socket. The green LED (O) will illuminate, the charger is now in standby mode and ready for a battery to be connected.

#### Note:

Sparks may be produced when the plug is inserted into the power supply but this isn't a problem in terms of safety.

- Connect the battery pack into the charger; line up the alignment channels on the battery (P) with the corresponding channels on the charger (Q) and slide the battery into place.

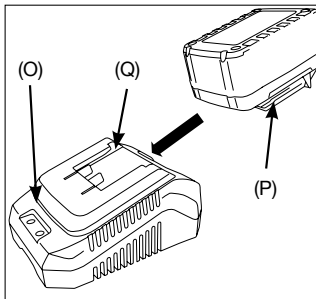

### WARNING!

When a battery becomes discharged due to prolonged use or exposure to direct sunlight or heat, always allow the battery pack to cool down before recharging. This will allow the battery to be recharged to its full capacity.

## Warranty & Support

### The Kielder 3 Year Warranty

To take advantage of the Kielder 3 year warranty the product **must be registered within 30 days of Purchase or Delivery.**

Please register your product by completing the online form at:  
**www.kielder.co**

...or call customer services on:  
**0114 242 3794**

#### Why is Registration a Requirement?

For Kielder to be able to fully support & service a product warranty over a 3 year period **it is imperative that the product is registered.** If the product hasn't been registered we're simply not able to fully administer a warranty of this duration and therefore can only offer a **standard 12 month guarantee for any unregistered product.**

***Note:** Batteries are excluded from the 3 Year Warranty. Battery packs are classed as being a consumable item and they have a separate fixed period warranty of 12 months.*

#### Warranty Statement

- Each Kielder product is thoroughly inspected during production and is guaranteed to perform as specified. The product will be free of defects, in both workmanship and materials, for the duration of the warranty from the date the product is purchased.
- The warranty becomes effective at the date of purchase (or the date of delivery if this is later).
- In the event that your machine needs repairing or replacing, you must provide proof of purchase/delivery before any work can be carried out on your machine. Without this, any work carried out may be chargeable.
- If your product requires attention from our engineers, we aim to have it collected & repaired within 7-10 working days.

- The repair or replacement of your machine under warranty will not extend the period of warranty.

- The warranty provides benefits which are additional to and do not affect your statutory rights as a consumer.

#### What is covered?

- The repair or replacement of your machine (at Kielder's discretion), if your machine is found to be defective due to faulty materials, workmanship or function within the warranty period (if any part is no longer available or out of manufacture, Kielder will replace it with a functional replacement part).
- Use of the machine in the UK only, overseas users should contact the official importer or retailer for that country.

#### What is not covered?

- Kielder does not guarantee the repair or replacement of a product incurred as a result of normal wear and tear. This includes any moving parts which are prone to wear and tear, over time; such as Jaws, Seals & Bearings.
- Usage of the product within a construction site environment.
- Accidental damage, faults caused by negligent use or care, misuse, neglect, careless operation or handling of the product which is not as instructed in Kielder's Instruction manual.
- Batteries are excluded from the 3 Year warranty.
- Use of parts which are not assembled or installed in accordance with the instructions of Kielder.
- Use of parts which are not Kielder genuine components.
- Faulty installation (except installation by Kielder).
- Repairs or alterations carried out by parties other than Kielder.

#### How to contact Kielder

If you have any queries over your product, please don't hesitate to contact us via:

**tools@kielder.co**

or call customer services on:

**0114 242 3794.**

...and we'll be happy to help.





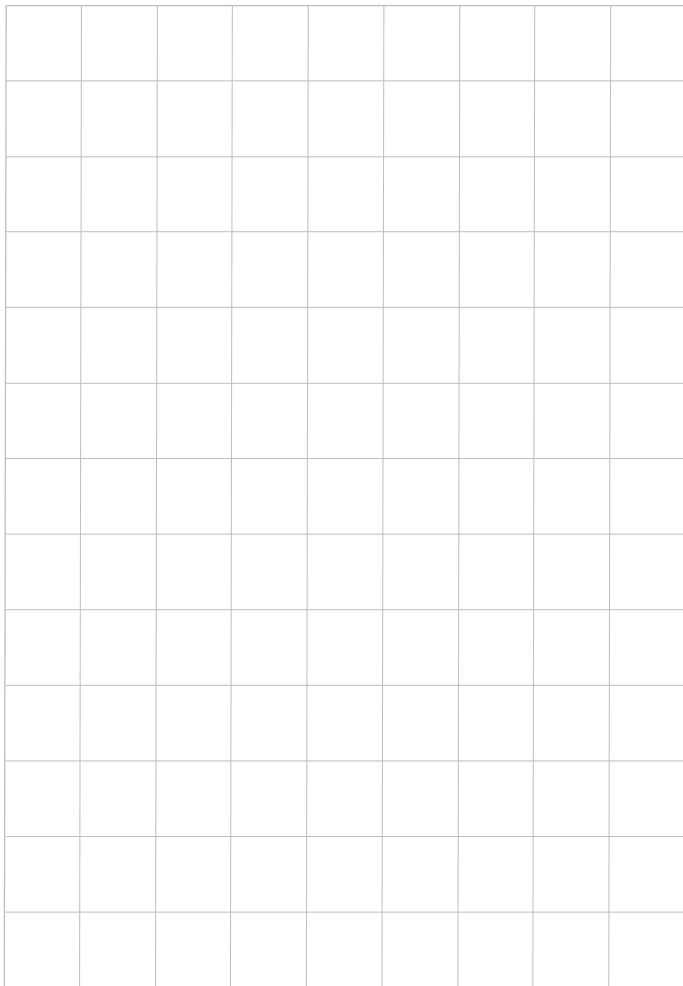



# KielderWT<sup>®</sup>

KIELDER WORKS TEAM

Kielder WT Ltd  
Sheffield, UK

**T:** +44 (0)114 242 3794

**E:** [tools@kielder.co](mailto:tools@kielder.co)

**W:** <http://www.kielder.co>

