



DIVISION ENVIRONNEMENT  
ENVIRONMENT DIVISION

À votre service depuis **1985**  
Serving you since

# KROKO



Catalogue 2007









[WWW.CANADATAG.COM](http://WWW.CANADATAG.COM)

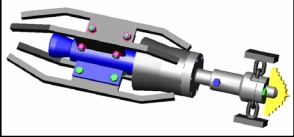
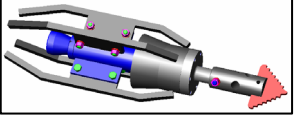
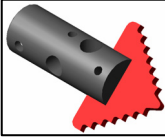

FABRIQUÉ AU CANADA  
MADE IN CANADA

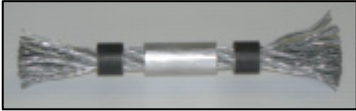
CATALOGUE 2007 CATALOG

[WWW.CANADATAG.COM](http://WWW.CANADATAG.COM)

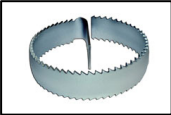
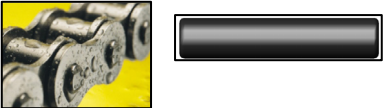
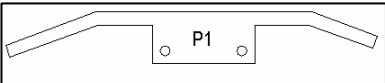
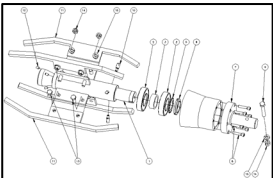
	<b>INDEX</b>	<b>PAGES</b>
	<b>PRÉSENTATION ET UTILISATIONS KROKO KROKO PRESENTATION AND USE</b>	<b>3-4 3-4</b>
	<b>VERSION DE BASE DU KROKO KROKO'S BASIC VERSION</b>	<b>5 5</b>
	<b>PORTE-OUTILS SPÉCIAUX SPECIAL HOLDERS</b>	<b>6 6</b>
	<b>PATINS, RALLONGES, POINTES PERÇANTES SKIDS, EXTENSIONS SKIDS, DRILL POINTS</b>	<b>7 7</b>
	<b>CÂBLES BROSSE D'ACIER STEEL WIRES BRUSH</b>	<b>8 8</b>
	<b>CÂBLES D'ACIER AVEC EMBOUTS WIRES WITH TIP</b>	<b>9 9</b>
	<b>CHAÎNES À ROULEAU ROLLER CHAINS</b>	<b>10 10</b>
	<b>CHAÎNES À MAILLES AVEC &amp; SANS EMBOUT PLAT MESH CHAINS WITH FLAT TIP &amp; WITHOUT TIP</b>	<b>11 11</b>
	<b>LAMES / SCIES CONCAVES CONCAVE BLADE SAWS</b>	<b>12 12</b>
	<b>APPLICATIONS SPÉCIALES SPECIAL APPLICATIONS</b>	<b>13 13</b>
	<b>UTILISATION DES PATINS &amp; RALLONGES SKIDS &amp; EXTENSIONS USE</b>	<b>14 14</b>
	<b>VUE EXPLOSIVE DES PIÈCES KROKO KROKO PARTS VIEW</b>	<b>15 15</b>

# KROKO



## VERSATIL TURBINE ROOT CUTTER

## COUPE-RACINES TURBINE VERSATILE Ø Raccord NPT : 1 NPT

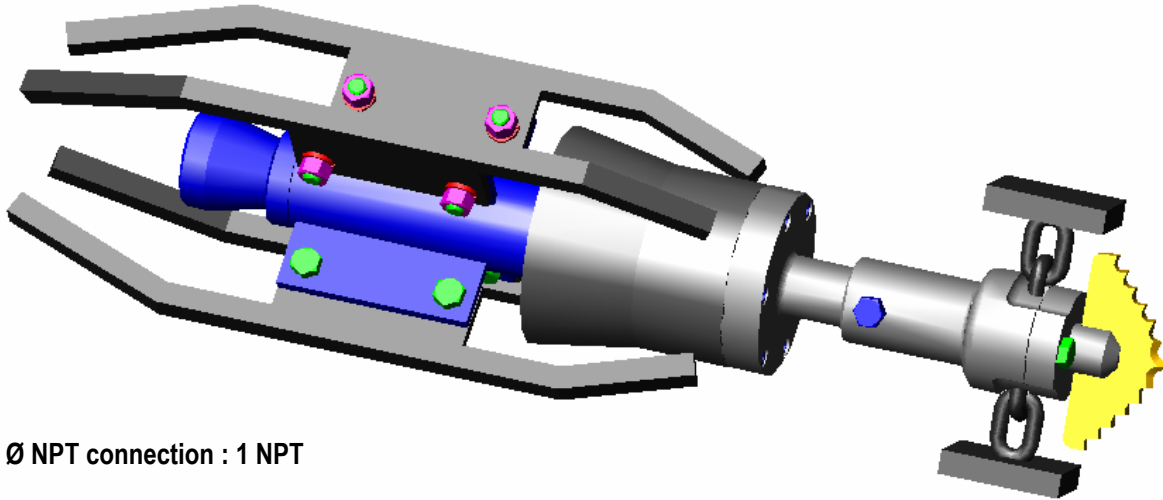

Ø NPT connection : 1 NPT

### FEATURES

- CUT : wood, roots, grease, deposit and more.
- SIZE: for 8" to 24" pipe diameter.
- Power assisted by a turbine.
- Rotating with 2 high quality bearings.
- High heat grease : **180 °C ( 356 °F)**
- Low maintenance, **no lubrication needed.**
- Low operation cost (chains and wires).
- Steel resistant construction.
- All jets are removable and made of stainless steel
- Operating 1800-3000 psi and 50-80 gpm.
- Depending on the various sizes of the chains, wires or cutters; the rotation achieve between 2500-4000 RPM, *comparatively to 500 RPM for the hydraulic root cutter.*
- Net weight : **25 Lbs (11.36 Kg).**
- Overall length with holder: 23 inch.
- **IMPORTANT:** Use "KROKO" with appropriate guides skids to diameter of pipe.

### AVANTAGES

- COUPE: bois, racines, graisse, dépôts et plus.
- Pour canalisation de 8" à 24" de diamètre.
- Puissance assistée par turbine.
- Rotation avec 2 roulements à billes hautes qualités
- Graisse haute teneur en chaleur : **180 °C ( 356 °F)**
- Maintenance minime, **sans lubrification.**
- Coût d'opération réduit. (chaînes, câbles d'acier)
- Construit d'acier résistant.
- Tous les jets sont fabriqués en acier inox et sont tous amovibles.
- Fonctionne de 1800-3000 psi et 50-80 gpm.
- Selon la longueur des chaînes ou câbles d'acier; la rotation varie entre 2500-4000 RPM, *comparativement à 500 RPM pour le coupe-racines hydraulique.*
- Poids net : **25 Lbs (11.36 Kg).**
- Longueur totale avec porte-outils : 23 po.
- **IMPORTANT:** Utiliser "KROKO" avec patins appropriés au diamètre du tuyau.

# KROKO



## VERSATILE TOOL

### YOU CAN USE:

MESH CHAINS WITH FLAT TIPS  
MESH CHAINS WITHOUT TIP  
WIRES WITH TIPS  
WIRES STEEL BRUSH  
CONCAVE BLADE SAWS 8" à 12"  
ROLLER CHAINS  
NYLON RODS FOR SPECIAL PIPES  
FOR WORKS IN STAINLESS PIPES  
SKIDS, CHAINS AND MORE  
ACCESORIES ARE AVAILABLE  
ON REQUEST.

## OUTIL VERSATILE

### VOUS POUVEZ UTILISER

CHAÎNES À MAILLES EMBOUTS PLATS  
CHAÎNES À MAILLES SANS EMBOUT  
CÂBLES D'ACIER AVEC EMBOUTS  
CÂBLES BROSE D'ACIER  
LAMES/SCIES CONCAVES 8" à 12"  
CHAÎNES À ROULEAUX  
TIGE DE NYLON POUR TUYAUX SPÉCIAUX  
POUR TRAVAUX DANS TUYAUX  
DE STAINLESS; PATINS, CHAÎNES ET  
AUTRES ACCESOIRES SONT  
DISPONIBLES SUR DEMANDE.

MESH CHAINS WITH FLAT TIPS / CHAÎNES À MAILLES EMBOUTS PLATS

**KCP**

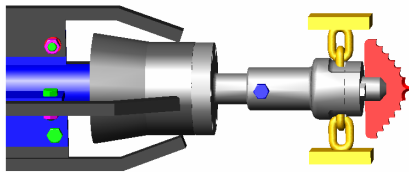

MESH CHAINS WITHOUT TIP / CHAÎNES À MAILLES SANS EMBOUT

**KCM**

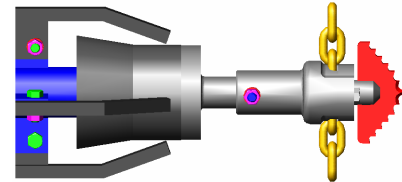

WIRES WITH TIP / CÂBLES D'ACIER AVEC EMBOUTS

**KWE**

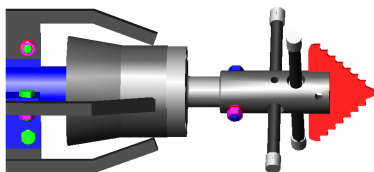

WIRES STEEL BRUSH / CÂBLES BROSE D'ACIER

**KWB**

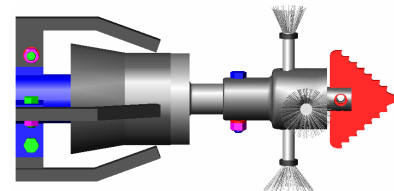

CONCAVE BLADE SAWS 8"to 12" / LAMES/SCIES CONCAVES 8"à 12"

**KLC**

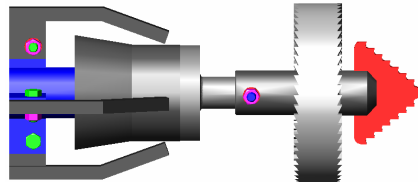
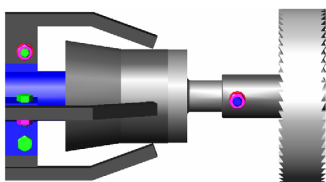

ROLLER CHAINS / CHAÎNES À ROULEAUX

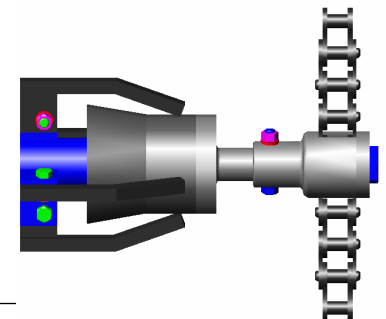



# KROKO



VERSATIL TURBINE ROOT CUTTER

COUPE-RACINES TURBINE VERSATILE

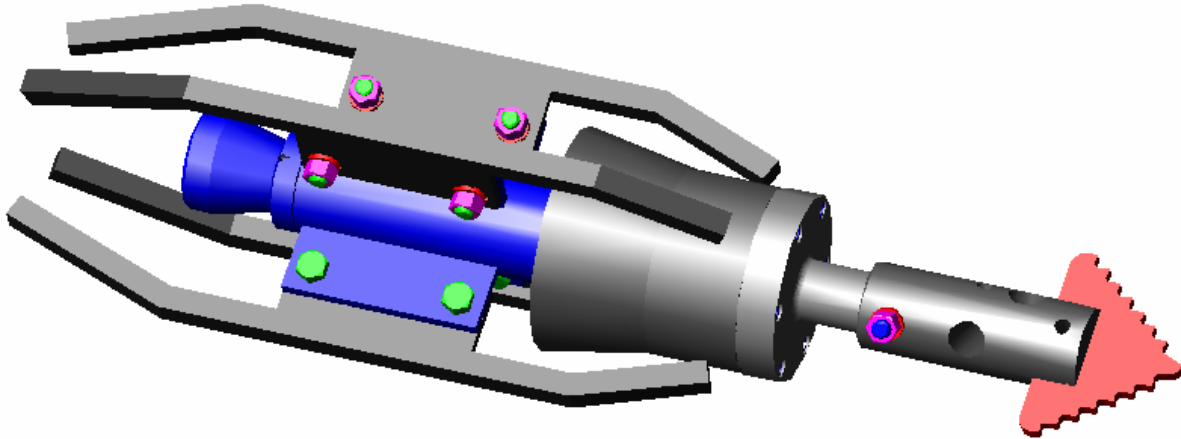

- THE KROKO PURCHASE INCLUDES THE  
**FOLLOWING EQUIPMENTS :**

- À L'ACHAT DU KROKO, LES **ÉQUIPEMENTS**  
**INCLUS** SONT LES SUIVANTS :

Qty	Item Code	Description
1	<b>KROKO</b>	Kroko versatil turbine root cutter
		<b>Equipment included:</b>
1	<b>KAC</b>	Chains Adaptor 5/16 inch + Drill point 4 inch
1	<b>KAWE</b>	Holder Wires with tips + Drill point 4 inch
1	<b>KPR824</b>	Skids kit & skids extension
1		2 metal trunks
2	<b>KWE8</b>	Steel wires with tips for pipes 8"
2	<b>KWE10</b>	Steel wires with tips for pipes 10"
2	<b>KWE12</b>	Steel wires with tips for pipes 12"
1	<b>KCP8</b>	Mesh Chains 5/16 with flat tips for pipes 8"
1	<b>KCP10</b>	Mesh Chains 5/16 with flat tips for pipes 10"
1	<b>KCP12</b>	Mesh Chains 5/16 with flat tips for pipes 12"
		<b>FORMATION WITH THE CUSTOMER</b>

Qté	Code item	Description
1	<b>KROKO</b>	Coupe-racines turbine versatile Kroko
		<b>Équipements inclus :</b>
1	<b>KAC</b>	Adapteur Chaînes 5/16 po. + pointe 4 po.
1	<b>KAWE</b>	Porte-Outil Câbles + Pointe perçante 4 po.
1	<b>KPR824</b>	Ensemble Patins & Rallonges
1		Ensemble de 2 coffres métalliques
2	<b>KWE8</b>	Câbles d'acier avec embouts pour tuyaux 8"
2	<b>KWE10</b>	Câbles d'acier avec embouts pour tuyaux 10"
2	<b>KWE12</b>	Câbles d'acier avec embouts pour tuyaux 12"
1	<b>KCP8</b>	Chaînes 5/16 avec embouts plats pour tuyaux 8"
1	<b>KCP10</b>	Chaînes 5/16 avec embouts plats pour tuyaux 10"
1	<b>KCP12</b>	Chaînes 5/16 avec embouts plats pour tuyaux 12"
		<b>FORMATION AVEC LE CLIENT</b>

MODEL NO# / MODÈLE NO#	PRICE / PRIX
<b>KROKO</b>	

# ACCESSORIES / ACCESSOIRES



## SPECIAL HOLDERS / PORTE-OUTILS SPÉCIAUX

PRODUCT / PRODUIT

MODEL / MODÈLE NO#

DESCRIPTION

PRICE / PRIX

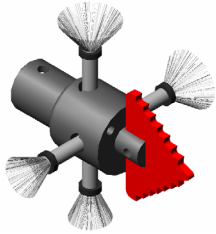

**KAWB**

WIRE BRUSH ADAPTOR (UNIVERSAL)  
ADAPTEUR CÂBLE BROSSE (UNIVERSEL)

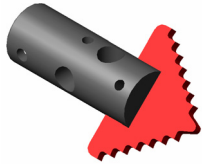

**KAWE**

WIRE ADAPTOR WITH TIPS (ONLY)  
ADAPTEUR CÂBLE AVEC EMBOUTS (SEULEMENT)

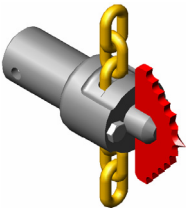

**KAC**

MESH CHAINS ADAPTOR  
ADAPTEUR CHAÎNES À MAILLES

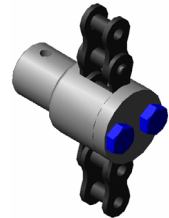

**KARC**

ROLLER CHAINS ADAPTOR  
ADAPTEUR CHAÎNES À ROULEAUX



**KASP**

SAWS ADAPTOR /BLADES WITH DRILL POINT  
ADAPTEUR LAMES/SCIES AVEC POINTE



**KAS**

SAWS/BLADES ADAPTOR  
ADAPTEUR LAMES/SCIES

# ACCESSORIES / ACCESSOIRES



## SKIDS & EXTENSIONS / PATINS & RALLONGES

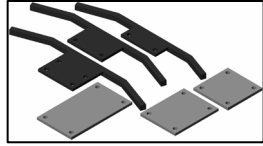

**COMPLETE KIT FOR 8" TO 24" PIPES**  
**ENSEMBLE COMPLET TUYAUX 8" À 24"**

**KPR824**

**PRICE / PRIX \$**

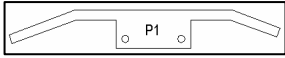

**P1 KIT (4 SKIDS INCLUDED)**  
**ENSEMBLE P1 (INCLUS 4 PATINS)**

**KP1**

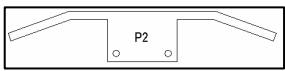

**P2 KIT (4 SKIDS INCLUDED)**  
**ENSEMBLE P2 (INCLUS 4 PATINS)**

**KP2**



**P3 KIT (4 SKIDS INCLUDED)**  
**ENSEMBLE P3 (INCLUS 4 PATINS)**

**KP3**



**R4 KIT (4 EXTENSIONS INCLUDED)**  
**ENSEMBLE R4 (INCLUS 4 RALLONGES)**

**KR4**

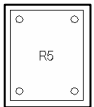

**R5 KIT (4 EXTENSIONS INCLUDED)**  
**ENSEMBLE R5 (INCLUS 4 RALLONGES)**

**KR5**

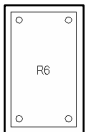

**R6 KIT (4 EXTENSIONS INCLUDED)**  
**ENSEMBLE R6 (INCLUS 4 RALLONGES)**

**KR6**

## DRILL POINTS / POINTES PERÇANTES

**DESCRIPTION**

**NUMBER / NUMÉRO#**

**PRICE / PRIX \$**



**4" REMOVABLE DRILL POINT**  
**POINTE PERÇANTE 4" AMOVIBLE**

**KDP4**

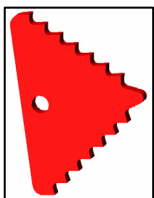

**4" REMOVABLE DRILL POINT**  
**POINTE PERÇANTE 4" AMOVIBLE**

**KDP6**

# ACCESSORIES / ACCESSOIRES



## WIRES / CÂBLES D'ACIER

### FEATURES

WIRES ARE SELF-RIGID, SO THAT DRIVINGS ARE EASIER INTO THE PIPES.

### AVANTAGES

LES CÂBLES D'ACIER SONT SEMI-RIGIDES, FACILITANT AINSI LES MANŒUVRES DANS LES CONDUITS.



### WIRES / CÂBLES D'ACIER BRUSH / BROSSSE



- FOR CLAY, PVC, STEEL AND CONCRETE PIPES.
- IDEAL FOR MINI ROOTS, GREASE DEPOSIT AND **FINISH CLEANING**.
- FOR STAINLESS PIPES, YOU MUST USE STAINLESS WIRES AND SKIDS TO AVOID ALL CONTAMINATION AND RUST OF PIPES. THESE ACCESSORIES ARE AVAILABLE ON REQUEST.

- POUR TUYAUX D'ARGILE, PVC, ACIER ET BÉTON.
- IDÉAL POUR MINI RACINES, GRAISSE, DÉPÔTS ET **FINITION**.
- POUR TUYAUX D'ACIER INOX, UTILISEZ DES CÂBLES ET PATINS EN INOX POUR ÉVITER TOUTE CONTAMINATION ET ROUILLE DES CANALISATIONS. CES ACCESSOIRES SONT DISPONIBLES SUR DEMANDE.

PIPE / TUYAU Ø	NUMBER / NUMÉRO #	PRICE / PRIX \$
8"	KWB8	
10"	KWB10	
12"	KWB12	
14"	KWB14	
15"	KWB15	
16"	KWB16	
18"	KWB18	
20"	KWB20	
21"	KWB21	
22"	KWB22	
24"	KWB24	

- **NOTE** : USE ONLY THE WIRE BRUSH HOLDER (UNIVERSAL) **KAWB**.

- **NOTE**: UTILISER SEULEMENT LE PORTE-OUTIL CÂBLE BROSSSE (UNIVERSEL) **KAWB**.



# ACCESSORIES / ACCESSOIRES

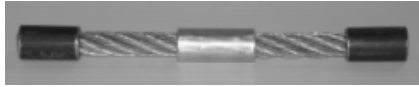

## WIRES / CÂBLES D'ACIER WITH TIPS / AVEC EMBOUTS

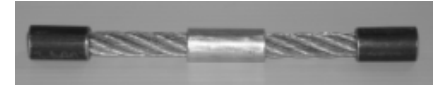

- STEEL TIP WIRES ARE EXTREMELY AGGRESSIVE, USE **ONLY** FOR SSTEEL AND CONCRETE PIPES.
- EXTREME SOLUTION FOR **GREASE AND WOOD PARTS**, WHILE USING THE DRILL POINT KDP4.

- LES CÂBLES D'ACIER AVEC EMBOUTS D'ACIER SONT D'UNE AGRESSIVITÉ EXTRÊME, UTILISER POUR TUYAUX D'ACIER OU BÉTON **SEULEMENT**.
- SOLUTION EXTRÊME POUR **GRAISSE ET PIÈCES DE BOIS** TOUT EN UTILISANT LA POINTE PERÇANTE KDP4.

PIPE / TUYAU Ø	NUMBER / NUMÉRO #	PRICE / PRIX \$
8"	KWE8	
10"	KWE10	
12"	KWE12	
14"	KWE14	
15"	KWE15	
16"	KWE16	
18"	KWE18	
20"	KWE20	
21"	KWE21	
22"	KWE22	
24"	KWE24	

- **NOTE** : USE ONLY THE FOLLOWING HOLDERS :

- WIRE WITH TIPS **KAWE**.
- WIRE BRUSH (UNIVERSAL) **KAWB**.

- **NOTE**: UTILISER SEULEMENT LES PORTE-OUTILS SUIVANTS :

- CÂBLE AVEC EMBOUTS **KAWE**.
- CÂBLE BROSSE (UNIVERSEL) **KAWB**.

# ACCESSORIES / ACCESSOIRES



## CHAINS / CHÂÎNES

### FEATURES

THE CHAINS ARE NOT RIGID, DURING THE KROKO ROTATION, THEY CONTINUALLY FIT TO THE PIPES.

### AVANTAGES

LES CHÂÎNES N'ÉTANT PAS RIGIDES, ELLES S'AJUSTENT CONTINUELLEMENT AUX TUYAUX LORS DU MOUVEMENT ROTATIF DU KROKO.



## ROLLER CHAINS / CHÂÎNES À ROULEAU



- NO DAMAGE FOR CLAY, PVC, STEEL AND CONCRETE PIPES.
- BEST FOR CRUSTS, SCALE, LIME, GREASE AND **FINISH CLEANING**.
- FOR STAINLESS PIPES, YOU MUST USE STAINLESS CHAINS AND SKIDS TO AVOID ALL CONTAMINATION AND RUST OF PIPES. THESE ACCESSORIES ARE AVAILABLE ON REQUEST.

- SANS DOMMAGE POUR TUYAUX D'ARGILE, PVC, ACIER OU BÉTON.
- IDÉAL POUR TUYAUX CROÛTÉS AVEC ÉCAILLES, GRAISSE, MATIÈRES VISQUEUSES ET **FINITION**.
- POUR TUYAUX EN INOX, UTILISER DES CHÂÎNES ET PATINS EN INOX POUR ÉVITER TOUTE CONTAMINATION ET ROUILLE DES CANALISATIONS. CES ACCESSOIRES SONT DISPONIBLES SUR DEMANDE.

PIPE / TUYAU Ø	NUMBER / NUMÉRO #	PRICE / PRIX \$
8"	KRC8	
10"	KRC10	
12"	KRC12	
14"	KRC14	
15"	KRC15	
16"	KRC16	
18"	KRC18	
20"	KRC20	
21"	KRC21	
22"	KRC22	
24"	KRC24	
KIT 10' (120")	KRC120	

- **NOTE<sup>1</sup>** : THE ROLLER CHAINS ARE AVAILABLES IN 10' LENGTH. CUT OFF THE DESIRED LENGTH.
- **NOTE<sup>2</sup>** : USE ONLY THE HOLDER ROLLER CHAINS **KARC**.

- **NOTE<sup>1</sup>** : LES CHÂÎNES À ROULEAU SONT DISPONIBLES EN LONGUEUR DE 10'. VOUS COUPEZ LES LONGUEURS DÉSIRÉES.
- **NOTE<sup>2</sup>** : UTILISER SEULEMENT LE PORTE-OUTILS CHÂÎNES À ROULEAUX **KARC**.

# ACCESSORIES / ACCESSOIRES



## MESH CHAINS / CHÂÎNES À MAILLES WITH FLAT TIP & / AVEC EMOBOUTS PLAT WITHOUT TIP & / SANS EMOBOUT



- FOR STEEL AND CONCRETE PIPES.
- IDEAL FOR **ROOTS**, **HARD DEPOSIT** AND CLEANING.
- THE FLAT TIP CHAINS ARE EXCELLENT FOR PIPES THAT ARE COMPLETELY BLOCKED BY **HARD DEPOSIT**.

- POUR TUYAUX ACIER ET BÉTON.
- IDÉAL POUR **RACINES**, **DÉPÔTS CALCAIRES** ET FINITION.
- LES CHÂÎNES AVEC EMOBOUTS PLATS SONT EXCELLENTES POUR LES TUYAUX COMPLÈTEMENT OBSTRUÉS DE **CALCAIRE**.

PIPE / TUYAU Ø	1 CHAIN WITH TIP 1 CHÂÎNE AVEC EMOBOUT PLAT	PRICE / PRIX \$	1 CHAIN WITHOUT TIP 1 CHÂÎNE SANS EMOBOUT	PRICE / PRIX \$
8"	KCP8		KCM8	
10"	KCP10		KCM10	
12"	KCP12		KCM12	
14"	KCP14		KCM14	
15"	KCP15		KCM15	
16"	KCP16		KCM16	
18"	KCP18		KCM18	
20"	KCP20		KCM20	
21"	KCP21		KCM21	
22"	KCP22		KCM22	
24"	KCP24		KCM24	

- **NOTE** : USE ONLY THE MESH CHAIN HOLDER **KAC**.

- **NOTE**: UTILISER SEULEMENT LE PORTE-OUTIL CHÂÎNE À MAILLES **KAC**.

# ACCESSORIES / ACCESSOIRES



## CONCAVE / LAMES-SCIES BLADE SAWS / CONCAVES

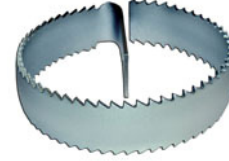

PIPE / TUYAU Ø	NUMBER / NUMÉRO #	PRICE / PRIX \$
8"	LC8	
10"	LC10	
12"	LC12	

- **NOTE** : USE ONLY THE FOLLOWING HOLDERS :

- SAWS/BLADES ADAPTOR **KAS**.
- SAWS/BLADES ADAPTOR WITH **KASP** DRILL POINT.

- **NOTE**: UTILISER SEULEMENT LES PORTE-OUTILS SUIVANTS :

- ADAPTEUR LAMES/SCIES **KAS**.
- ADAPTEUR LAMES/SCIES AVEC POINTE **KASP**.

# ACCESSORIES / ACCESSOIRES

## SPECIALS APPLICATIONS / APPLICATIONS SPÉCIALES

### FOR PVC OR PLASTIC PIPES POUR TUYAUX PVC OU PLASTIQUE

- BEST FOR PVC AND PLASTIC PIPES WITH **GREASE AND ROOTS**
- PLASTIC RODS AND SKIDS ARE AVAILABLES FOR YOUR WORKS, **ON REQUEST.**

 (418-838-2195)

- IDÉAL POUR TUYAUX DE PVC, PLASTIQUE CONTENANT **GRAISSE OU RACINES.**
- DES TIGES ET PATINS FABRIQUÉS DE PLASTIQUE SONT DISPONIBLES POUR VOS TRAVAUX, **SUR DEMANDE.**

 (418-838-2195)

### FOR STAINLESS PIPES POUR TUYAUX EN ACIER INOX



- BEST FOR **GREASE, ROOTS AND PAPER PASTES.**
- STAINLESS ROLLER CHAINS, MESH CHAINS, STAINLESS WIRES AND SKIDS ARE AVAILABLE FOR YOUR WORKS TO AVOID ALL CONTAMINATION AND RUST OF PIPES, **ON REQUEST.**

 (418-838-2195)

- IDÉAL POUR **GRAISSE, RACINES ET PÂTE DE PAPIER.**
- DES CHAÎNES À ROULEAUX, CHAÎNES À MAILLES, CÂBLES D'INOX ET PATINS FABRIQUÉS D'ACIER INOX SONT DISPONIBLES POUR VOS TRAVAUX AFIN D'ÉVITER CONTAMINATION ET ROUILLE DES TUYAUX, **SUR DEMANDE.**

 (418-838-2195)

### FOR BIG WORKS POUR GROS TRAVAUX

- FOR MANY WORKS IN OVER 24" PIPES, PLEASE CONSULT US.

 (418-838-2195)

- POUR DES TRAVAUX DANS DES TUYAUX DE PLUS DE 24", VEUILLEZ NOUS CONSULTER.

 (418-838-2195)



# SKIDS & EXTENSION SKIDS USAGE MÉTHODE D'UTILISATION DES PATINS & RALLONGES



## SKIDS PATINS

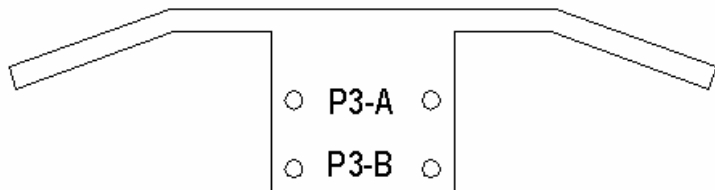
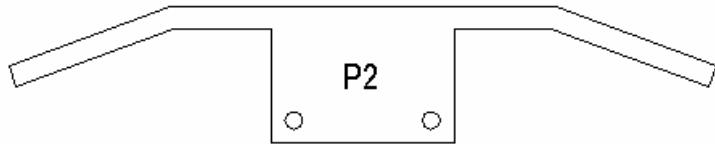
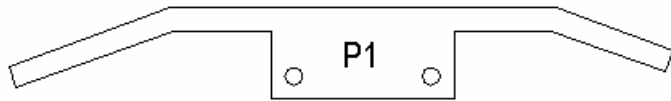

## EXTENSIONS RALLONGES

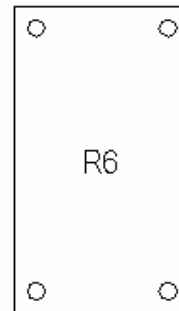
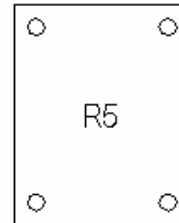
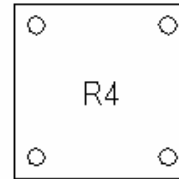

TUYAU Ø STD PIPE Ø STD	COMBINAISON COMBINATION
8"	P1
10"	P2
12"	P3-B
14"	(P1 + R4)
15"	(P3-A + R4)
16"	(P1 + R5) ou (P2 + R4)
18"	(P3-B + R4) ou (P2 + R5)
20"	(P1 + R6) ou (P3-B + R5)
21"	(P3-A + R6)
22"	(P2 + R6)
24"	(P3-B + R6)

# KROKO ROOT CUTTER PARTS VIEW VUE EXPLOSIVE DU COUPE-RACINES KROKO

**KROKO**

**NOMENCLATURE KROKO**

ITEM	QTÉ	NOM DE LA PIÈCE	NAME OF PIECE
1	1	CORPS	BODY
2	2	ROULEMENT À BILLES ÉTANCHE	SEALED BEARING
3	1	RONDELLE D'ESPACEMENT	SPACING WASHER
4	1	BARILLET	ROTOR
5	1	RONDELLE DENTELÉE	JAGGED WASHER
6	1	ÉCROU BARRURE CORPS	BODY LOCK NUT
7	1	BOUCHON ARBRE D'ENTRAÎNEMENT TRAINING SHAFT CAP	
8	6	VIS 1/4 - 20 SERRAGE BOUCHON	SCREW CAP LOCK
9	1	VIS HEXAGONE 3/8-16 X 2 1/4 INOX	HEX SCREW INOX 3/8-16 X 2 1/4
10	3	JET INOX 5/64	INOX JET 5/64
11	4	PATIN	SKID
12	3	JET INOX 3/32 ARRIÈRE	BACK INOX JET 3/32
13	16	VIS HEXAGONE 3/8-16 X 1 INOX	HEX SCREW INOX 3/8-16 X 1
14	17	ÉCROU HEXAGONE NYLON 3/8 - 16 INOX	NYLON NUT INOX 3/8-16
15	17	RONDELLE DE SERRAGE 3/8	LOCK WASHER 3/8

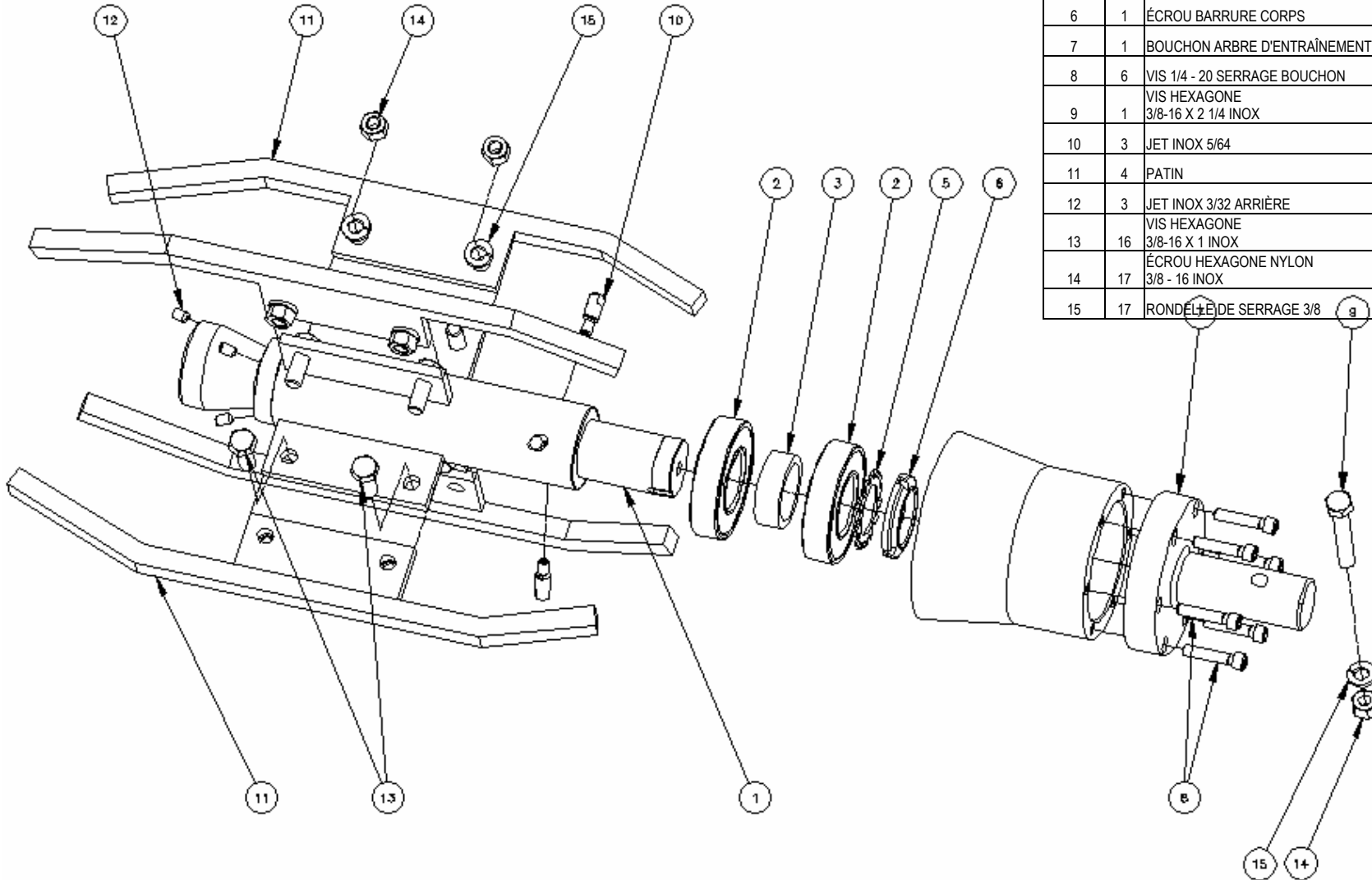

# Commande / Order

No commande / Order number: \_\_\_\_\_

Date: \_\_\_ / \_\_\_ / \_\_\_

Transporteur/Carrier:
No#:

ADRESSE FACTURATION BILLING ADDRESS
Nom/Name:
Rue/Street:
Ville/City:
C.P./Postal code:
De/From:
Courriel/E-mail:
Téléphone/Telephone:
Télécopieur/Fax:

ADRESSE LIVRAISON SHIPPING ADDRESS
Nom/Name:
Rue/Street:
Ville/City:
C.P./Postal code:
Responsable/ Person in charge:
Courriel/E-mail:
Téléphone/Telephone:
Télécopieur/Fax:

<b>IMPORTANT</b> : Pour vous assurer des « Buses » adaptées à vos besoins ! To make sure you get "Nozzles" that fits your need!	
Quel est votre consommation d'eau (pompe) Gallons/minute ? What is your water consumption (pump) Gallons/minute?	GPM
Quel est votre pression (pompe) ? What is your pressure (pump)?	PSI

Item #	Qté Qty	Code Item Item Code	Description	Prix unit. Unit Price	Total
<i>L'équipe TAG vous remercie</i> <i>Thanks from the TAG team!</i>				TPS/GST	
				TVQ/QST	
				TOTAL	