



watering systems

Growing within your grasp



# Welcome to AutoPot

From the greenhouse in your garden to acres of commercial glasshouses; AutoPot can provide any grower of any ability with a watering system, large or small, that will far exceed their expectations.

Thanks to the AQUAvalve technology; AutoPot is the only watering system in the world where each individual plant controls their own irrigation and receives fresh nutrient enriched water exactly when they need it.

By consistently meeting the plants requirements, growers using AutoPot achieve even growth across the entire crop.



## Why use our watering systems?

- ▶ Healthier, heavier yielding plants that receive fresh feed whenever they need it
- ▶ No more daily watering, the system can be left unattended for weeks
- ▶ All our systems operate without electricity, pumps, timers or mains water
- ▶ Proven to be one of the most water efficient irrigation systems worldwide
- ▶ Environmentally sustainable, no water is ever lost
- ▶ Can be used to grow any crop variety; edible or ornamental
- ▶ Adaptable and easily extended in minutes

AutoPot makes growing as simple as it can be... less effort bigger yields

## Contents

AQUAVALVE .....	4	1POT XL SYSTEMS .....	12 – 13	FEED / FITTINGS.....	21
NEW FOR 2017 .....	5	AQUAPLATE .....	14	SUBSTRATE GUIDE .....	22
EASY2PROPAGATE .....	6	WHITEPOTS .....	15	COCOMAT .....	23
EASY2GOKIT .....	7	FLEXITANKS .....	16	CASE STUDIES .....	24
1POT SYSTEMS.....	8 – 9	FLEXITANK PRO.....	17	LITTLE GROWERS .....	25
EASY2GROW SYSTEMS .....	10 – 11	AQUABOX .....	18 – 19	TOP TIPS.....	26 – 27
		AIRDOME .....	20		



For more information on system sizes visit [autopot.co.uk](http://autopot.co.uk)



3D

The AQUAvalve is supplied with every AutoPot Watering System. Once connected to the water supply, the AQUAvalve will control the flow of water to the plants by simple gravity pressure from a reservoir or tank of any size. No pumps, mains water pressure, electricity or timers are required.

Once connected to a reservoir the AQUAvalve will open and allow water to fill the tray to a pre-set level of 20mm. The AQUAvalve will not refill the tray until all the water has been used; this ensures that the plants are not constantly sat in water. Once all the water has been used by the plants the AQUAvalve will re-open and refill the tray.

The AQUAvalve is a simple and very effective watering device, so needs to be treated with care. Keep the AQUAvalve and the tray it sits in clean, free of obstructions, soil particles and it will feed and water your plants for many years.

## How the AQUAvalve works

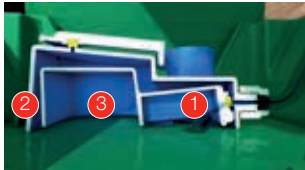

Once the tank is filled with water and liquid feed, it will begin to travel through the pipe from the tank. It will pass through the AQUAvalve nozzle (1) and into the tray. As the tray fills (2) with water air is trapped inside the main body and around the 'inner float' causing it to rise (3).

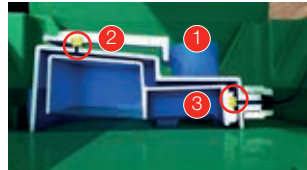

As the water level increases in the tray the 'top float' will rise (1). Releasing the trapped air inside the main body (2). This will in turn allow the 'inner float' to rise and shut off the supply (3). The water level is now 20mm.

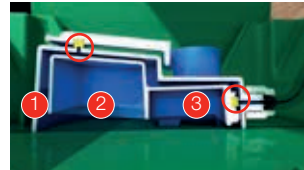

Potted plants in the tray will start to reduce the water level (1). As the water level reduces the 'top float' will close creating a vacuum inside the 'main body' of the AQUAvalve (2). This vacuum traps water inside the 'main body' and in turn keeps the 'inner float' up and the incoming water shut off (3).

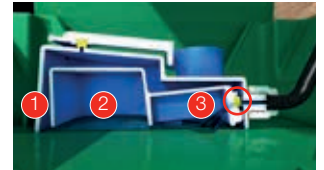

When the water level in the tray has run out completely (1) the surface tension around the main body of the AQUAvalve will break, this can take up to 30 minutes. As this happens all the water that is trapped inside the 'main body', keeping the 'inner float' up and the water supply shut off is released, allowing the 'inner float' (2) to drop and open the water supply (3).

## Tips

① When connecting 6mm or 16mm pipe always ensure that the end of the pipe is dipped in hot water first, this will soften the pipe and allow you to connect fittings with ease.

② When potting up, use a small brush to remove any soil stuck to the sides and bottom of the pots before you place them into the tray. This will ensure the tray and AQUAvalve are kept clean and free of floating growing medium.



## Propagate properly

easy2Propagate is the largest, most adjustable single piece propagator on the market. It's size and ventilation capacity make controlling your growing conditions simple and mean a vast range of climatic options are achievable.

For further details see page 6



## Strong, healthy plants on a plate

Grow free from substrate with AutoPot AQUAplate. The AQUAplate allows you to grow hydroponically with mesh pots in an AutoPot tray giving plants direct root access to nutrient rich water. AQUAplate is the ideal growing environment for quick to harvest plants.

For further details see page 14



## The revolution refined

FlexiTank Pro is yet another advance in our program to bring AutoPot Watering Systems to every kind of growing environment. A reflective, light-tight skin makes the FlexiTank Pro the perfect solution in bright, high temperature situations. Further enhancements come in the shape of internal capacity markings and an ultra-strong, anti-tip design.

For further details see page 17



# New for 2017

# easy2Propagate kit™



easy2Propagate's size and features deliver entirely new levels of growing potential and plant control.

A cavernous 200mm lid height offers your plants more headroom than any other single piece propagator lid available giving you greater choice as to when you transplant. Four large, fully adjustable vents allow growers unparalleled scope to fine-tune an environment in which young plants can thrive.

easy2Propagate ties together the proven growing technology of the AutoPot range. Fitted with four 6mm piping ports, it is designed to accommodate an AQUAvalve for easy integration with low maintenance AutoPot Watering Systems. The lid and kit contents slot together in minutes to create a stunningly effective propagator.

Available in four different kit configurations



easy2Propagate Complete



easy2Propagate Extension

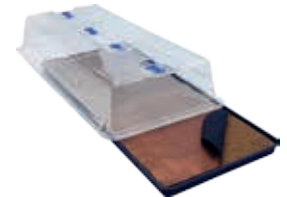

easy2Propagate Basic



easy2Propagate Lid

- ▶ Control your plants environment to accelerate rooting.
- ▶ Water young plants and cuttings with confidence.
- ▶ Increase strike rates with large volumes of young plants.
- ▶ All easy2Propagate kits and lids fully boxed.
- ▶ Ultra-strong lid easy to ship even as a single unit.

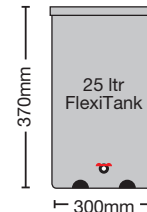
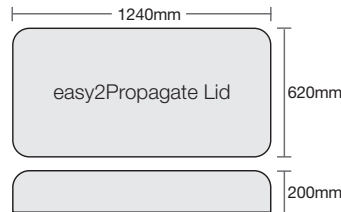

FlexiTank dimensions when filled with water

## Tips

- 1 Use heat pads under the tray or propagation lights above it to warm the water in the tray and create humidity.
- 2 We recommend a target temperature of 70-80°F / 25-30°C with minimum 80% humidity.
- 3 If you are using raised pots, such as terracotta pots or bonsai pots, a small length of capillary matting can be cut and pushed inside the hole at the bottom of the raised pot. The capillary matting will act as a wick.



The easy2GO Kit is the ultimate holiday watering kit for happy, healthy plants. By incorporating the AQUAvalve, the easy2GO Kit will keep your plants watered for weeks using a simple gardening tray and reservoir. The easy2GO Kit is placed directly onto the tray along with your potted plants and distributes water to the pots from below.

Unlike other holiday watering kits, the easy2GO Kit provides optimum levels of water to meet the plants requirements - without the need for timers or electricity - ensuring you return from holiday to plants that are thriving.

The easy2GO Kit can be installed anywhere, in the home, greenhouse, conservatory, patio or balcony and multiple kits can be linked together to keep larger volumes of plants watered while you're away.

This inexpensive, flexible system can be assembled in minutes and contains all fittings required to connect to a reservoir of your choice. You simply need a water container with a minimum 30 litre capacity and a flat based gardening tray with a minimum depth of 30mm.

3D

### easy2GO Kit in 4 simple steps

- 1 Connect reservoir to the easy2GO Kit
- 2 Place easy2GO Kit on a level tray
- 3 Place your plant pots in the garden tray
- 4 Fill reservoir with water and liquid fertiliser (if required)



### Tips

- 1 Use the spirit level on the easy2GO Kit to ensure the tray is level.
- 2 Place washed gravel / clay pebbles or similar in the bottom of each pot, to aid drainage.
- 3 For the best results, we recommend mineral fertilizers. Do not use organic fertilizers, as they have a tendency to block small pipe work.
- 4 Always place easy2GO Kit directly on the trays surface, never sit it on capillary matting.

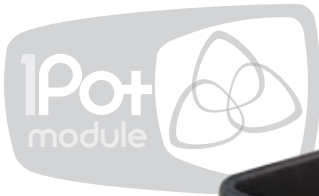

The 1Pot module is the number one best seller for AutoPot in the UK and performs extremely well in both national and international horticultural markets.

Whatever medium you choose the 1Pot system enables gardeners and growers of all abilities to achieve incredible yields from their plants. The 1Pot System is easily extended and many 15L pots can be linked to a single reservoir. The pots and trays are modular and can be easily spaced apart as plants grow. Once assembled, the reservoir is filled with water and liquid fertiliser (if required), the system will completely take care of all your plant's feeding requirements, providing them with fresh, balanced feed throughout their entire life cycle.

This versatile system can be used in the home, greenhouse, poly-tunnel or garden to feed and water your plants and offers an easy and efficient watering system for all manner of crops whether edible or ornamental.

3D

## Accessories + fittings



## Dimensions

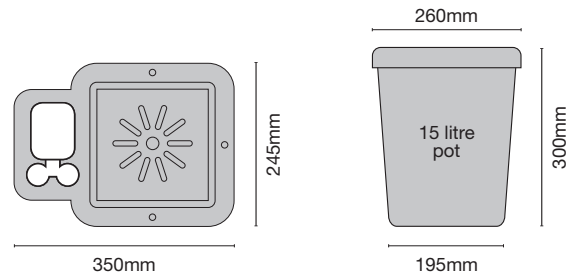

## 😊 Tips

- 1 The 15 litre pots used in the 1Pot module and the 8.5 litre pots used in the easy2grow system are interchangeable and can be used in either tray design.
- 2 We recommend using four 1Pot modules per square metre of growing space.

- 3 To ensure even better growing results it is highly recommended to place 1" (25mm) of washed gravel or pH stable clay pebbles in the bottom of each pot. Then place your substrate of choice on top, pot up and water through.



4Pot System  
with retail box



24Pot System



80Pot System



100Pot System



## 1Pot System™ layouts

1Pot Systems are available in a range of size layouts including

1 2 4 6 8 12 24 36 48 60 80 100 1,000 10,000

The 1Pot System™  
will just keep extending

**It does not stop at 100 pots**



3D

## Accessories + fittings



## Dimensions

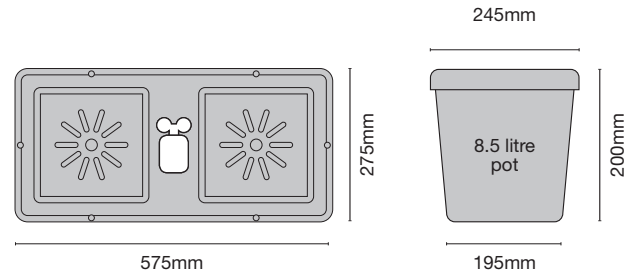

## Tips

- 1 Raise your reservoir to a minimum of 150mm above the highest AQUAvalve and re-fill the tank when there is approximately a 1/3 of solution left. This will keep the valves working effectively.
- 2 We recommend using three easy2grow modules (6 plants) per square metre of growing space.

- 3 To ensure even better growing results it is highly recommended to place 1" (25mm) of washed gravel or pH stable clay pebbles in the bottom of each pot. Then place your substrate of choice on top, pot up and water through.

easy2grow kit



easy2grow 40



easy2grow 80



easy2grow 100



## easy2grow System™ layouts

easy2grow Systems are available in a range of size layouts including

2 4 6 12 16 20 24 40 48 60 80 100 1,000 10,000

easy2grow System™  
will just keep extending

It does not stop at 100 pots

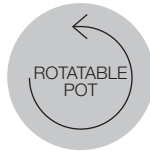
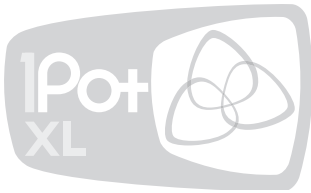

3D

Developed by AutoPot to meet the demands of the ambitious gardener, featuring a MASSIVE 25 litre growing capacity the 1Pot XL is perfect for growers looking to cultivate BIG plants and achieve even BIGGER yields.

This original design has a clam shaped tray that accommodates the large volume 25 litre XL pot. The round based pot enables the grower to easily rotate a big plant while the pot is still in the tray.

Ideal for large specimen plants, such as Blueberry bushes or Japanese Maples, the 1Pot XL can be used as a single unit system or linked to larger reservoirs to create huge systems of any size or configuration.

The 1Pot XL is supplied with all necessary connections and the AQUAvalve that controls the water supply to each and every plant in the system, delivering fresh, balanced feed throughout their entire life cycle.

## Accessories + fittings



## Dimensions

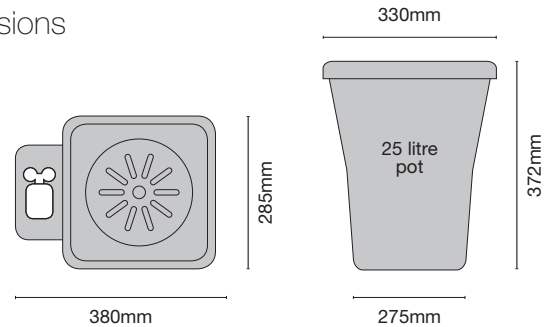

## 😊 Tips

- ① Growing over 6 plants? Increase the size of your reservoir and pipe, use 16/6mm crosses and tees to connect your AQUAvalves to the 16mm supply pipe.
- ② We recommend using two 1Pot XL modules per square metre of growing space.
- ③ To ensure even better growing results it is highly recommended to place 1" (25mm) of washed gravel or pH stable clay pebbles in the bottom of each pot. Then place your substrate of choice on top, pot up and water through.

8Pot XL System



24Pot System



80Pot XL System



100Pot XL System



## 1Pot XL System™ layouts

1Pot XL Systems are available in a range of size layouts including

1 2 4 6 8 12 24 48 60 80 100 1,000 10,000

The 1Pot XL System™ will just keep extending

**It does not stop at 100 pots**

# AQUAplate



AQUAplate simply brings a whole new dimension to your AutoPot Watering System. Everything you need to adapt an AutoPot tray for pure hydroponic growing is contained within the kit. The seamless integration that AQUAplate affords you saves time, expense and allows you to grow in our proven, highly efficient, low-maintenance irrigation system.

Collar and mesh pot your plants, slot them into the plate and drop into your AutoPot tray and you're growing hydroponically!

In an AutoPot system with AQUAplate plants thrive through only ever receiving fresh irrigation and nutrients unlike recirculating systems.



- ▶ Grow free from substrate
- ▶ Give plants direct root access to nutrient rich water
- ▶ Encourage faster, stronger root development
- ▶ Contains all you need to adapt your existing AutoPot system for AQUAplate growing
- ▶ Includes PotSock for superior root control
- ▶ Simply drops into an AutoPot tray



AQUAplate Circle fits an XL Tray



AQUAplate Square fits 1Pot or easy2grow trays



## Tips

- 1 Add an airstone to the tray for supercharged growing.
- 2 AQUAplate is the ideal growing environment for quick to harvest plants such as leafy greens.



## WhitePots - Happy Roots, Bigger Fruits!

Protect your plant's root system from high or shifting temperatures with AutoPot WhitePots. The WhitePot reflects extremes of heat away from the root system. By shielding the roots in this way WhitePots help prevent the adverse effects of hot or varying temperatures on a plants growth management.

Growing in WhitePots is a simple and effective way to maintain constant temperatures for your roots allowing your plants to steadily thrive.

- ▶ Reflects light and heat
- ▶ Specially designed for use in hot environments
- ▶ Helps reduce root temperatures



As well as assisting with root temperature stability for European growers WhitePots are currently in full commercial use in a number of locales with extreme climates. WhitePots have proven a huge success in Thailand, Saudi Arabia, the US and the Pacific Islands.



WhitePot 25L fits an XL Tray



WhitePot 15L fits a 1Pot or easy2grow Tray



WhitePot 8.5L fits a 1Pot or easy2grow Tray

## Dimensions

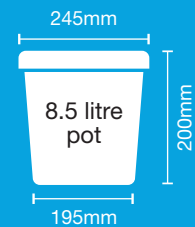



Struggling to fit a plastic reservoir into your car or home is now a thing of the past! The FlexiTank range is available in a variety of sizes and revolutionises water storage for every gardener, whether on a domestic or commercial scale. FlexiTanks reduce storage and shipping costs and take minutes to assemble, no tools required.

Everything a gardener needs in one compact box.

It really couldn't be simpler.



3D

### FlexiTank features

- ▶ Fully collapsible
- ▶ Fold away into one compact box
- ▶ Lightweight and durable
- ▶ Easy to ship and store
- ▶ No tools required for assembly
- ▶ Fits where other reservoirs cannot go



The 25 and 50 litre FlexiTanks allow you to grow almost anywhere. Perfect for hobby and small-scale growers these additions to the FlexiTank range mean that almost no space is now too small for a system.

### Dimensions (when filled with water)



Box size and weight:  
36 x 16 x 13cm/1.3kg



Box size and weight:  
52 x 16 x 13cm/1.8kg



Box size and weight:  
73.5 x 18 x 12.5cm/1.8kg



Box size and weight:  
78.5 x 18 x 12.5cm/2.7kg



Box size and weight:  
112 x 18.5 x 12.5cm/4.8kg



Box size and weight:  
119 x 18 x 14 cm/6.25kg

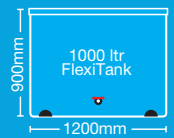

Box size and weight:  
89 x 20 x 16 cm / 7.30kg





The Revolution Refined: the FlexiTank Pro offers even greater scope for growing with AutoPot Watering Systems in extreme climates. The elegance of FlexiTank Pro's reflective and light-tight skin is the embodiment of form and function combined.

The FlexiTank Pro's skin beautifully disguises an extremely rugged, fully collapsible design within. Concealed tank supports and internal capacity markings add neat edges to the proven, ultra-strong, ultra-practical FlexiTank design.

- ▶ Reflective and light tight
- ▶ Ultra-strong, anti-tip design
- ▶ Internal capacity markings
- ▶ Simple assembly in minutes
- ▶ All fittings included
- ▶ Attractive retail box packaging

### Accessories + fittings

FlexiTank and FlexiTank Pro utilise the same accessories and fittings for easy integration with existing AutoPot Watering Systems



### Dimensions (when filled with water)

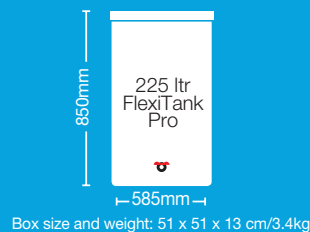



## the concept



3D

The AQUAbox incorporates the AQUAvalve technology used throughout the AutoPot range and expands it to irrigate a large growing area rather than a single plant pot. Ideal for raised beds, large planters, grow bags and allotments the AQUAbox is placed directly in the ground and distributes water and nutrient to the surrounding soil using capillary matting.

The AQUAbox ensures your plants are watered for days or weeks at a time making it the perfect irrigation solution for weekends away, holidays or year-round watering. They require no electricity, pumps, timers, mains water to operate and are ideal for use in allotments or home gardening. A connection to a reservoir is all that is needed. Water from the reservoir is simply supplied by gravity to the AQUAbox.

We are confident that there is nothing available worldwide that offers such versatility for direct soil watering whilst maintaining AutoPot's efficiency and simplicity.

**There are two products in the AQUAbox range;**

AQUAbox Straight is designed for narrow raised beds and grow bags.

AQUAbox Spyder is designed for larger raised beds and allotments.



AQUAbox Straight



AQUAbox Spyder

### Tips

- 1 Ensure the AQUAbox is level in the soil by using the circular spirit level in the lid.
- 2 Connect multiple AQUAbox Straights or Spydres to one water supply to irrigate a larger area.

## AQUAbox growing in 5 easy steps

- 1 Simply place the AQUAbox and capillary matting into the ground.
- 2 Connect to a tank or reservoir.
- 3 The capillary matting pulls the water from the AQUAbox and distributes it into the soil below.
- 4 The roots of your plants head to the water source and attach to the capillary matting.
- 5 Top up the tank or reservoir with water and liquid fertiliser (if required).

## How the AQUAbox works

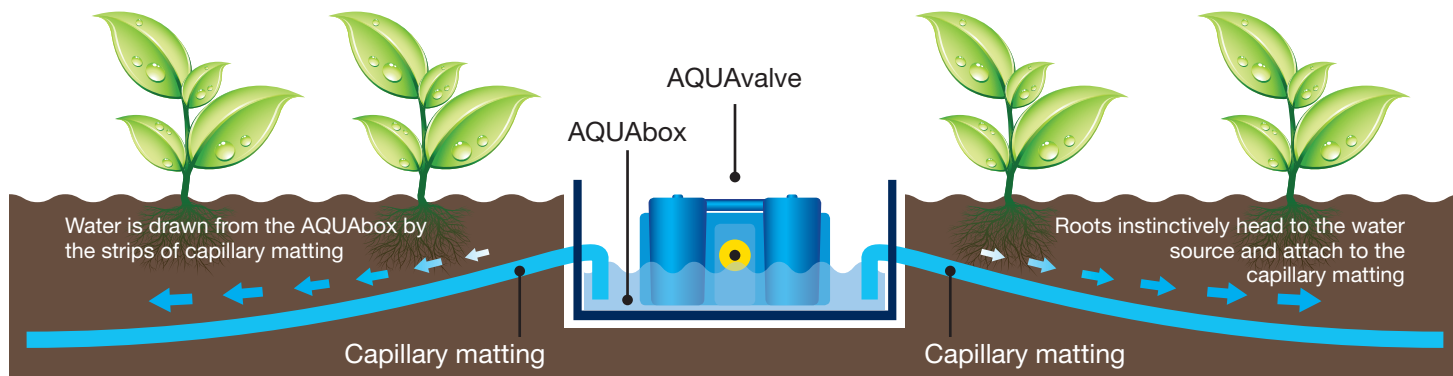

## Retail unit



## Tips

- 1 Ensure each strip of capillary matting slopes away from the AQUAbox at a slight downward gradient.
- 2 Roots will attach themselves to the matting. For best results, replace capillary matting every season.



3D

## AirDome features

- ▶ Healthier roots
- ▶ Greater uptake of water & nutrient
- ▶ Faster growth rates
- ▶ Bigger yields

Supercharge your plants! The AirDome has been designed to boost growth and yields by increasing the oxygen content in the pot. More oxygen means a healthier root zone and greater uptake of water and nutrient; your plants will grow bigger and yield significantly more.

In AirDome trials with Luffa plants we achieved an increase in yield of 130%! For more common varieties of fruiting plants, you can expect an increase in yields of up to 30%!

The Domes are very simple to use and take less than 30 seconds to assemble. The AirDome is placed at the bottom of the pot, covered with compost and then connected to an air pump.

can increase yields by up to **130%**\*



Place the AirDome in the bottom of the pot and connect to an air pump



The plant grows faster due to the abundance of air around the root zone

## 😊 Tips

- 1 To maximize the effectiveness of the AirDome use a 'fluffy' mix, such as 50% good quality compost and 50% perlite. Avoid peat based compost as this will compress, reducing the effectiveness of the AirDome.

\*increases vary according to plant type and conditions

- 2 If using AirDomes with large systems, consider using larger pumps that allow you to connect 16mm pipe (standard hosepipe). Mirror your water supply and reduce the pipe to 6mm at each AirDome connection, using AutoPot fittings. Never blow cold air into the root zone, only warm air.



The easy2grow liquid feed has been specially formulated to be used with all the AutoPot products. During recent trials it outperformed all the rest. easy2grow liquid feed is perfect for use with all kinds of vegetables, fruit and plants.

- ▶ Simple to use 1 part feed, for all plant types and stages of growth
- ▶ Added seaweed
- ▶ Minimal sediment build up, ensuring clean lines and piping
- ▶ Dilutes extremely well in water
- ▶ Remains mixed and does not separate

easy2grow liquid feed is available in these sizes (Litres)

---

0.25                                  1    5    20

---

## Fittings

AutoPot provide a wide range of fittings for our products to enable you to create a system to fit your growing space. We provide 16mm and 6mm fittings, filters, grommets for tanks, taps and pipe. Everything you need to set up a complete system of any size.



6mm golf filter



16mm - 6mm tee connector



16mm - 6mm cross connector



16mm inline filter



16mm - 6mm inline filter



Grommets 19mm / 16mm / 6mm

# SUBSTRATE GUIDE



Soil/Perlite  
50 / 50 mix

AutoPot Watering Systems are extremely versatile and can be used with the growing medium / substrate of your choice. Whether growing in soil, coco or hydroponically our systems exceed all expectations.

An ideal substrate for use in AutoPot systems is a 50% mix of perlite with either soil or coco. In growing trials we have cultivated plants in a vast range of substrates from coral to denim and even pumice stone! We are now successfully trialling the systems without media for aeroponic plant growth.

Which ever substrate you decide to use make sure the blend of substrates are capillary active and have the ability to hold plenty of air within the structure.

We are now successfully trialling the systems without media for aeroponic plant growth.



Growstones/Coco  
50 / 50 mix



Soil/Clay Pebbles  
50 / 50 mix



Coco/Perlite  
50 / 50 mix



Coco/Clay Pebbles  
50 / 50 mix



Rockwool/Clay Pebbles  
50 / 50 mix

## ☺ Tips

- 1 Always use a good quality soil or coco from a reputable brand.
- 2 AutoPot strongly recommends that Growstones, washed gravel or pH stable clay pebbles **should** be used at the bottom of each pot to a depth of 1 (25mm), to aid drainage.'
- 3 Peat based composts will compress when used in the systems, reducing the oxygen content in the root zone. Mix in perlite or clay pebbles to lighten the compost and improve aeration.
- 4 If using clay pebbles, whether at the bottom of the pot as additional drainage or as part of a mix, they **MUST** be pH stable. Be aware that certain brands are **NOT** pH stable and will increase the pH of the water in the tray; this will negatively affect plant growth.

# COCOMAT



CocoMat is the ideal addition for growers seeking a low maintenance irrigation system. The coco fibres and natural latex in a CocoMat wick all the moisture and nutrients a plant requires! Fill your tray just once and CocoMat will water the plants for up to ten days.

To use simply place the CocoMat into a propagation tray. Lay a Root Control Sheet onto the mat and sit small pots or seed trays on top. CocoMats can be cut to fit any size of tray.

CocoMat is available as:



51cm x 30cm x 3cm  
with Root Control Sheet



58cm x 51cm x 3cm  
without Root Control Sheet

## CocoMat in 3 easy steps

- 1 Simply place your CocoMat into a tray
- 2 Fill the tray with water
- 3 Place your seed tray on top and grow!

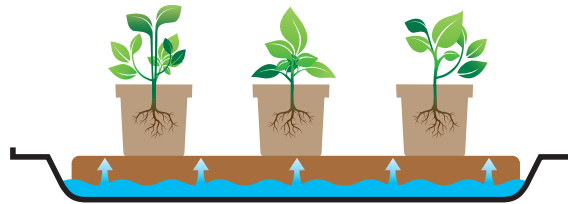

The CocoMat controls watering by holding and gradually wicking the water to the plants via capillary action.

## 😊 Tips

- 1 Irrigate larger trays using multiple CocoMats and Root Control Sheets. CocoMats and Root Control Sheets can be cut to fit any size of tray
- 2 Team you CocoMat with an AutoPot easy2GO to create an automated watering kit!
- 3 If you are using raised pots, such as terracotta pots or bonsai pots, a small length of capillary matting can be cut and pushed inside the hole at the bottom of the raised pot. The capillary matting will act as a wick.

# CASE STUDIES

## Brill View Farm UK

Last growing season we grew over 2000 plants at our facility Brill View Farm, Oxfordshire. Plant varieties included Thai Aubergines, Sweet Peppers, Thai Basil, Vietnamese Coriander and several types of Tomato and Chillies. All cultivated in AutoPot Watering Systems.



## Harvest on the Hill Farm, Barbados

Harvest on the Hill Farm in Barbados has installed 2700 AutoPot easy2grow systems on site, with plants growing in three 4000 square foot poly tunnels. They produce a continuous harvest of between 800 to 1600 lbs of Cucumbers per week which are distributed to local hotels, supermarkets and visiting cruise ships.

## Kennesaw, USA

Kennesaw State University in Georgia, USA are cultivating fresh produce for their population of 25,000 students. They are using several large easy2grow systems to grow tomatoes on a commercial scale and are converting further greenhouses to produce a wide variety of edible crops.



## Valley Grown Salads, UK

Following independent horticultural trials undertaken by Valley Grown Salads - a major supplier of Peppers and Salads to UK supermarket chains Waitrose and Co-Op - conclusive results showed that AutoPot Watering Systems reduced water and fertiliser usage by 45% compared to traditional irrigation methods.



## AutoPot are the proud and long standing sponsors of Little Growers

Little Growers provides horticultural equipment, advice and support to schools across the UK and now worldwide, encouraging children and communities to grow, learn and work together for a healthier and greener future. Little Growers offer a range of horticultural equipment to schools.

### United Kingdom

Little Growers now has over 100 school projects across the UK working with children of all ages and abilities. Little Growers UK has a vast range of projects, from 60ft greenhouses to 40 square metre plots of raised beds where the children grow a variety of produce throughout the year.

### Japan

Little Growers now has three schools in Japan using both the easy2grow system and the AQUAbox products with great success.

### Maldives

Little Growers now has five schools in the Maldives using the easy2grow system and AQUAbox Spyders. The children grow a range of produce which is then sold to hotel chains for use in their restaurants.

# TOP GROWING TIPS

1

The Root Control Discs (RCD) & Marix Discs work in the following configurations;

- a) Black Marix Disc in the pot, RCD in tray gold face up
- b) RCD in pot gold face down
- c) RCD in pot gold face down & RCD in tray gold face up.

2

To ensure excellent growing results it is highly recommended to place 1 (25mm) of Growstones, washed gravel or pH stable clay pebbles in the bottom of each pot. Then place your substrate of choice on top, pot up and water through.

3

If using AirDomes with large systems, consider using larger pumps that allow you to connect 16mm pipe (standard hosepipe). Mirror your water supply and reduce the pipe to 6mm at each AirDome connection, using AutoPot fittings. Never blow cold air into the root zone, only warm air.

4

Growing more than six plants - consider using a larger reservoir and supply the water via 16mm pipe (standard hosepipe) reducing the pipe to 6mm at each AQUAvalve connection, using AutoPot fittings.

5

Always clean the side and bottom of each pot before you place in the tray, this will remove any soil particles and ensure your system is clean. In turn ensuring your AQUAvalve is kept clean.

6

Always use a good clean liquid/powder mineral fertiliser. DO NOT use liquid Organic fertilisers, thick boosters or additives, if unsure mix a small amount in a glass of water overnight. If the following day the mixture has separated then it is not suitable for AutoPot, as it will separate in the pipework too, potentially causing blockages.



7

Allowing your plants to establish once they have been potted up, watered through and placed in the tray is very important before you turn your system on. The amount of time it takes depends on many factors, plant type, temperature, humidity, size of plant. This is generally 5-21 days dependant on pot size but if you are unsure simply feel the weight of the pot, if heavy there is plenty of moisture in the pot, if light simply turn the system on.

8

Never place an air stone in your reservoir as this can increase the pH of the water, a small water pump will work better but neither is essential.

---

9

To help keep your pipe work free of sediment build up, ensure you have a tap at the end of your pipework, this should be opened regularly every few weeks and the water allowed to drain into a jug or similar for 30 seconds to 1 minute.

---

10

Always raise your reservoir to a minimum of 150mm (6") above the floor, re-fill your reservoir when there is a 1/3 of the water left... Never let your reservoir run empty.

---

11

Always use a filter with every reservoir, filters should be checked once a month and cleaned if necessary.

---

12

Always ensure your AQUAvalve is secured to the tray to prevent it from floating as the water floods the tray, if using AutoPot designed trays simply position the half-moon of the AQUAvalve over the Tee section in the tray and push down firmly. If using the AQUAvalve in a garden tray place the newly designed AQUAvalve Cover MK2 over the AQUAvalve.

---

13

Placing trays on cold concrete floors is not advisable, the water in the tray will be chilled from below and will effect plant growth, consider placing polystyrene, cardboard or similar under each tray to ensure the water temperature in the tray is not affected. Trays can also be raised above the floor if required.

---

14

Flushing is not necessary with AutoPot, simply re-fill your reservoir with water only and pH balance if necessary and allow the plants to drink water only. This can be undertaken 7-14 days prior to picking your crops.

---

15

Placing small seedlings directly into the pots is not advisable. Only pot up suitably established plants.



---

16

Consider placing a humidity dome/lid over each plant when the plants are small and exposed, this will maintain the humidity around the plant speeding up growth.

---

17

In extreme circumstances of over feeding; pour several litres of pH balanced water into the pot and allow it to drain. Restart feeding with half strength nutrient for the 1st week.



watering systems

AutoPot Global Ltd  
Unit 5, 108 Hawley Lane, Farnborough  
Hampshire GU14 8JE  
UNITED KINGDOM

Tel: +44 (0)844 8581520  
Fax: +44 (0)870 3836953

Email: [mail@autopot.co.uk](mailto:mail@autopot.co.uk)  
Web: [www.autopot.co.uk](http://www.autopot.co.uk)

Your local distributor / retailer:

## Available worldwide



Manufacturer  
Email: [mail@autopot.co.uk](mailto:mail@autopot.co.uk)  
Web: [www.autopot.co.uk](http://www.autopot.co.uk)



Distributor  
Email: [info@autopot.fr](mailto:info@autopot.fr)  
Web: [www.autopot.fr](http://www.autopot.fr)



Distributor  
Email: [info@autopot.asia](mailto:info@autopot.asia)  
Web: [www.autopot.asia](http://www.autopot.asia)



Distributor  
Email: [info@autopot.nl](mailto:info@autopot.nl)  
Web: [www.autopot.nl](http://www.autopot.nl)



Distributor  
Email: [info@autopot-brasil.com](mailto:info@autopot-brasil.com)  
Web: [www.autopot-brasil.com](http://www.autopot-brasil.com)



Distributor  
Email: [info@autopot-usa.com](mailto:info@autopot-usa.com)  
Web: [www.autopot-usa.com](http://www.autopot-usa.com)

Bhut Jolokia chillies in AutoPot 1Pot Systems at Plantasia, Brill View Farm  
Image used with kind permission from Garden Culture