

NIECE

2017

ELECTRIC WATER CANNON MANUAL

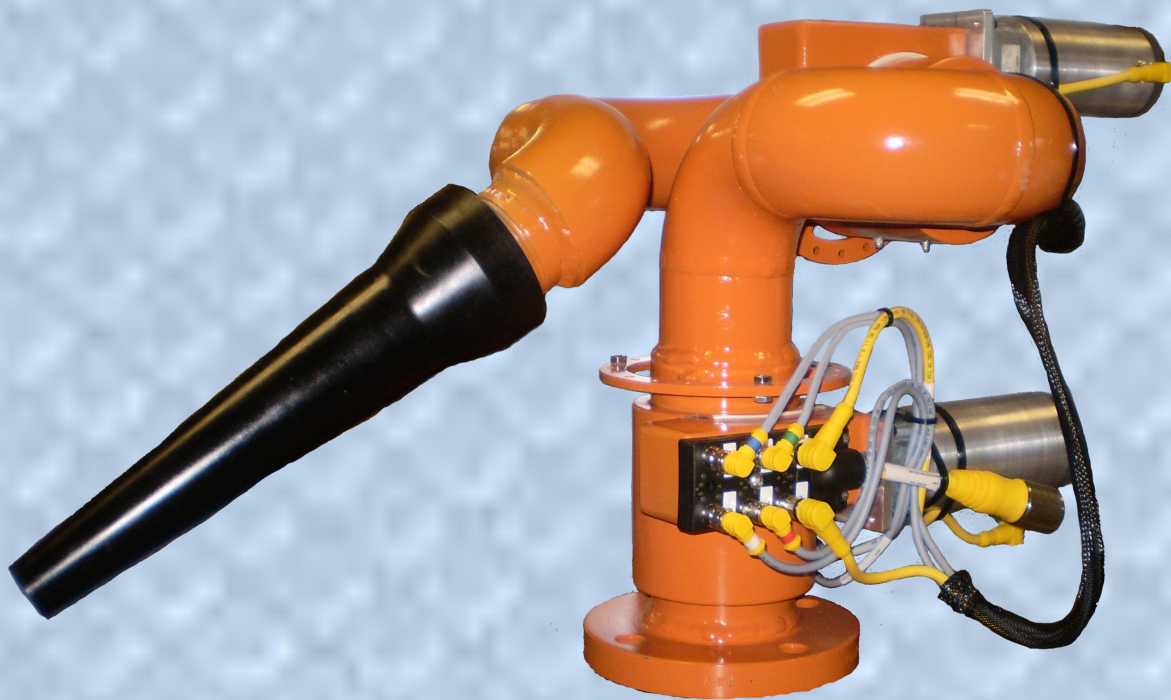

12 VOLT AND 24 VOLT COMPLETE KITS

CONTACT US:

TEXAS 512-252-3808

KANSAS 620-223-0340

EMAIL: info@nieceequipment.com

WEBSITE: nieceequipment.com



PAGE INTENTIONALLY LEFT BLANK



Niece production plant in Fort Scott Kansas

Toll Free 800-252-6618 Local 620-223-0340

NEW WEBSITE: www.nieceequipment.com



Niece production plant in Buda Texas

Toll Free 888-643-2372 Local 512-252-3808

NEW WEBSITE: www.nieceequipment.com

ITEM	FEATURES	PART NUMBER
<p>WATER CANNON 12 VOLT</p> 	<p>FULL 3" WATER FLOW CONSTRUCTION</p> <p>HEAVY DUTY SWIVELS</p> <p>HIGH TORQUE 12 VOLT GEAR MOTORS</p> <p>ADJUSTABLE ROTATION STOPS</p> <p>3" FLANGE MOUNT WATER INLET</p> <p>2-1/2" MNPT NOZZLE MOUNT</p>	<p>34051482</p>
ITEM	FEATURES	PART NUMBER
<p>WATER CANNON 24 VOLT 3" INLET BASE</p> 	<p>FULL 3" WATER FLOW CONSTRUCTION</p> <p>HEAVY DUTY SWIVELS</p> <p>HIGH TORQUE 24 VOLT GEAR MOTORS</p> <p>ADJUSTABLE ROTATION STOPS</p> <p>3" FLANGE MOUNT WATER INLET</p> <p>2-1/2" MNPT NOZZLE MOUNT</p>	<p>34050776</p>
ITEM	FEATURES	PART NUMBER
<p>WATER CANNON 24 VOLT 4" INLET BASE</p> 	<p>FULL 3" WATER FLOW CONSTRUCTION</p> <p>HEAVY DUTY SWIVELS</p> <p>HIGH TORQUE 24 VOLT GEAR MOTORS</p> <p>ADJUSTABLE ROTATION STOPS</p> <p>4" FLANGE MOUNT WATER INLET</p> <p>2-1/2" MNPT NOZZLE MOUNT</p>	<p>34057452</p>

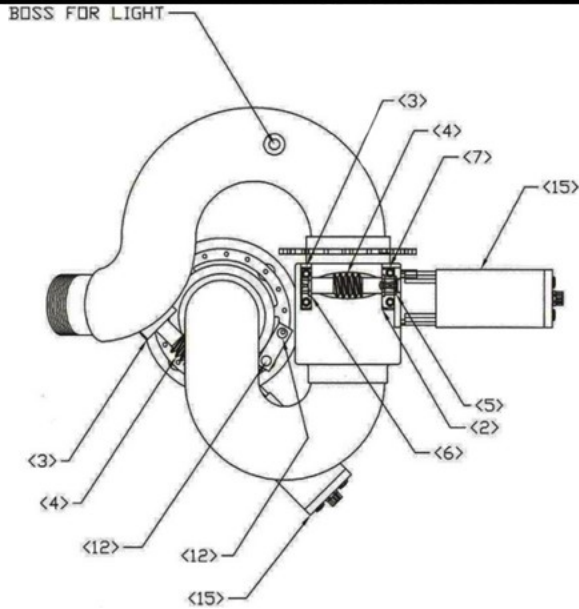

WATER CANNON 12 VOLT 3" BASE Part Number 34051482

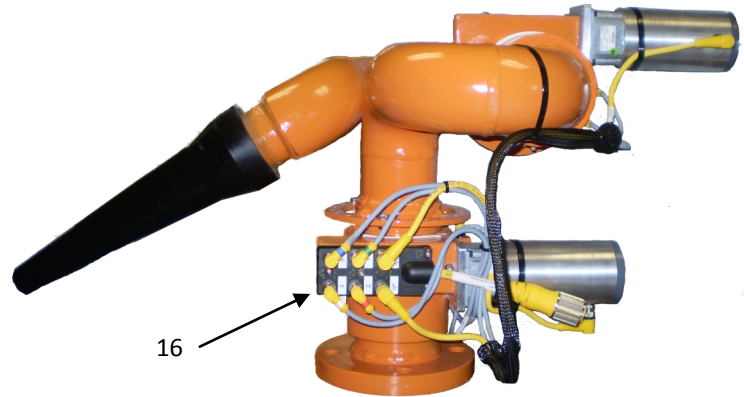

ITEM	DESCRIPTION	QTY	PART NUMBER
1	TURRET ASSEMBLY 3" BASE	1	34053026
2	LARGE WORM SUPPORT	2	05050779
3	SMALL WORM SUPPORT	2	05050778
4	WORM GEAR SHAFT	2	34050789
5	SUPPORT BEARING LARGE	2	04050783
6	SUPPORT BEARING SMALL	2	04050784
7	SOCKET HEAD CAP SCREW	4	15051382
8	LOWER GEAR COVER	1	90010810325
9	UPPER GEAR COVER	1	07055973
10	1/4" SOCKET HEAD CAP SCREW	8	15053025
12	PROXIMITY SWITCH	4	14053796
13	BULKHEAD CONNECTOR PROXIMITY SWITCHES	4	14053795
14	BULKHEAD CONNECTOR 12 PIN	1	14053791
15	MOTOR ASSEMBLY 4 PIN 12 VOLT	2	27058083
16	NEW STYLE JUNCTION PORT	1	60000810022
17	CABLE .5 METER ROTATION PROXIMITY	2	60000810018
18	CABLE 1 METER UP/DOWN PROXIMITY	2	60000810019
19	UP/DOWN MOTOR CABLE .9 METER	1	60000810021
20	RIGHT/LEFT MOTOR CABLE .4 METER	1	60000810020
21	CONTROL CABLE 30 FEET 12 PIN	1	14053790
22	BULKHEAD CONNECTOR 4 PIN MOTOR	2	14053799
23	CONTROL PANEL 12 VOLT	1	11056007
24	HEX HEAD BOLT POSITION STOP	4	15030808
25	HEX NUT POSITION STOP	4	15031152

BOSS FOR LIGHT

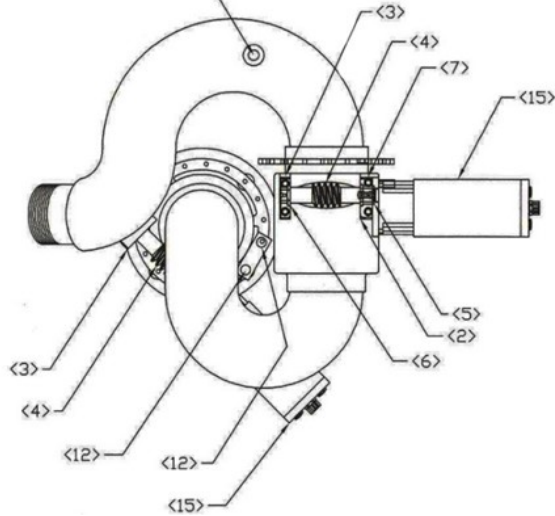

WATER CANNON 24 VOLT 3" BASE Part Number 34050776

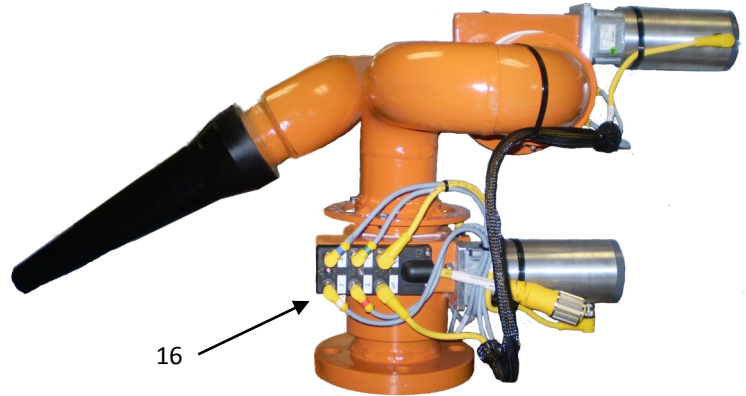



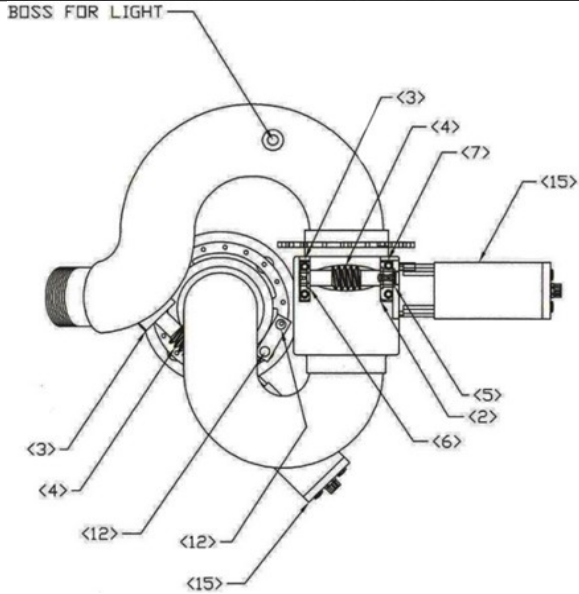

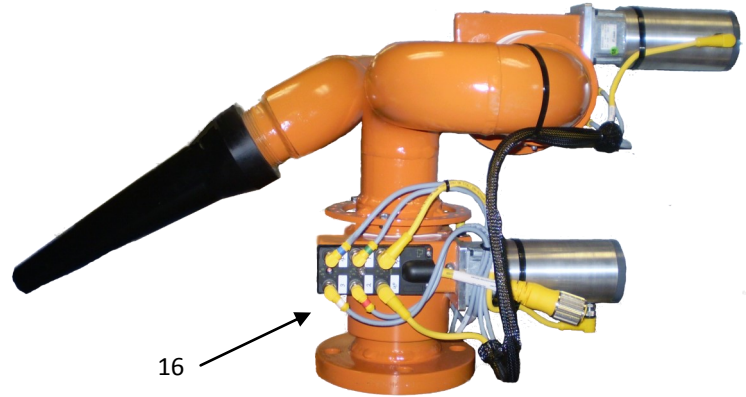

ITEM	DESCRIPTION	QTY	PART NUMBER
1	TURRET ASSEMBLY 3" BASE	1	34053026
2	LARGE WORM SUPPORT	2	05050779
3	SMALL WORM SUPPORT	2	05050778
4	WORM GEAR SHAFT	2	34050789
5	SUPPORT BEARING LARGE	2	04050783
6	SUPPORT BEARING SMALL	2	04050784
7	SOCKET HEAD CAP SCREW	4	15051382
8	LOWER GEAR COVER	1	90010810325
9	UPPER GEAR COVER	1	07055973
10	1/4" SOCKET HEAD CAP SCREW	8	15053025
12	PROXIMITY SWITCH	4	14053796
13	BULKHEAD CONNECTOR PROXIMITY SWITCHES	4	14053795
14	BULKHEAD CONNECTOR 12 PIN	1	14053791
15	MOTOR ASSEMBLY 4 PIN 24 VOLT	2	27052998
16	NEW STYLE JUNCTION PORT	1	60000810022
17	CABLE .5 METER ROTATION PROXIMITY	2	60000810018
18	CABLE 1 METER UP/DOWN PROXIMITY	2	60000810019
19	UP/DOWN MOTOR CABLE .9 METER	1	60000810021
20	RIGHT/LEFT MOTOR CABLE .4 METER	1	60000810020
21	CONTROL CABLE 30 FEET 12 PIN	1	14053790
22	BULKHEAD CONNECTOR 4 PIN MOTOR	2	14053799
23	CONTROL PANEL 24 VOLT	1	11056001
24	HEX HEAD BOLT POSITION STOP	4	15030808
25	HEX NUT POSITION STOP	4	15031152



WATER CANNON 24 VOLT 4" BASE Part Number 34057452



ITEM	DESCRIPTION	QTY	PART NUMBER
1	TURRET ASSEMBLY 4" BASE	1	34057451
2	LARGE WORM SUPPORT	2	05050779
3	SMALL WORM SUPPORT	2	05050778
4	WORM GEAR SHAFT	2	34050789
5	SUPPORT BEARING LARGE	2	04050783
6	SUPPORT BEARING SMALL	2	04050784
7	SOCKET HEAD CAP SCREW	4	15051382
8	LOWER GEAR COVER	1	90010810325
9	UPPER GEAR COVER	1	07055973
10	1/4" SOCKET HEAD CAP SCREW	8	15053025
12	PROXIMITY SWITCH	4	14053796
13	BULKHEAD CONNECTOR PROXIMITY SWITCHES	4	14053795
14	BULKHEAD CONNECTOR 12 PIN	1	14053791
15	MOTOR ASSEMBLY 4 PIN 24 VOLT	2	27052998
16	NEW STYLE JUNCTION PORT	1	60000810022
17	CABLE .5 METER ROTATION PROXIMITY	2	60000810018
18	CABLE 1 METER UP/DOWN PROXIMITY	2	60000810019
19	UP/DOWN MOTOR CABLE .9 METER	1	60000810021
20	RIGHT/LEFT MOTOR CABLE .4 METER	1	60000810020
21	CONTROL CABLE 30 FEET 12 PIN	1	14053790
22	BULKHEAD CONNECTOR 4 PIN MOTOR	2	14053799
23	CONTROL PANEL 24 VOLT	1	11056001
24	HEX HEAD BOLT POSITION STOP	4	15030808
25	HEX NUT POSITION STOP	4	15031152

ITEM	FEATURES	PART NUMBER
CONTROL PANEL 12 AND 24 VOLT 	SIMPLE INSTALLATION COMPACT DESIGN ARTICULATED MOVEMENTS IN TWO AXIS AT A TIME SWIVEL MOUNTING BRACKET FUSED SYSTEM FOR SYSTEM PROTECTION CIRCUIT BOARD CONSTRUCTION	12 VOLT #11056007 24 VOLT #11056001
		CIRCUIT BOARDS 12 VOLT #14062447 24 VOLT #14060870
		JOYSTICK PART #14051187
ITEM	FEATURES	PART NUMBER
CONNECTING CABLE 	WEATHER TIGHT CONNECTORS UV RAY RESISTANT 15 AND 30 FEET LENGTHS 12 CONDUCTOR CABLE 12 PIN WEATHER TIGHT CONNECTIONS	14053790
ITEM	FEATURES	PART NUMBER
WATER CANNON NOZZLE 	URETHANE CONSTRUCTION 2-1/2" FNPT MOUNTING OPTIONAL STREAM STRAIGHTENER	35057421
ITEM	FEATURES	PART NUMBER
STREAM STRAIGHTENER 	URETHANE CONSTRUCTION DESIGNED TO SHAPE WATER STREAM IN NOZZLE	35056665
ITEM	FEATURES	PART NUMBER
RAM MOUNTING BRACKET 	RADIAL ADJUSTMENTS COMPACT MOUNTING BRACKET ADJUSTABLE FOR EACH OPERATOR	05061220
ITEM	FEATURES	PART NUMBER
TURRET MOTOR 	SEALED ALUMINUM HOUSING SHEAR PIN TO AVOID DAMAGE TO MOTOR HIGH TORQUE GEAR DRIVE MOTOR DESIGNED FOR HEAVY DUTY SERVICE	12 VOLT 27058083 24 VOLT 27052998
		DRIVE PIN PART #29061795

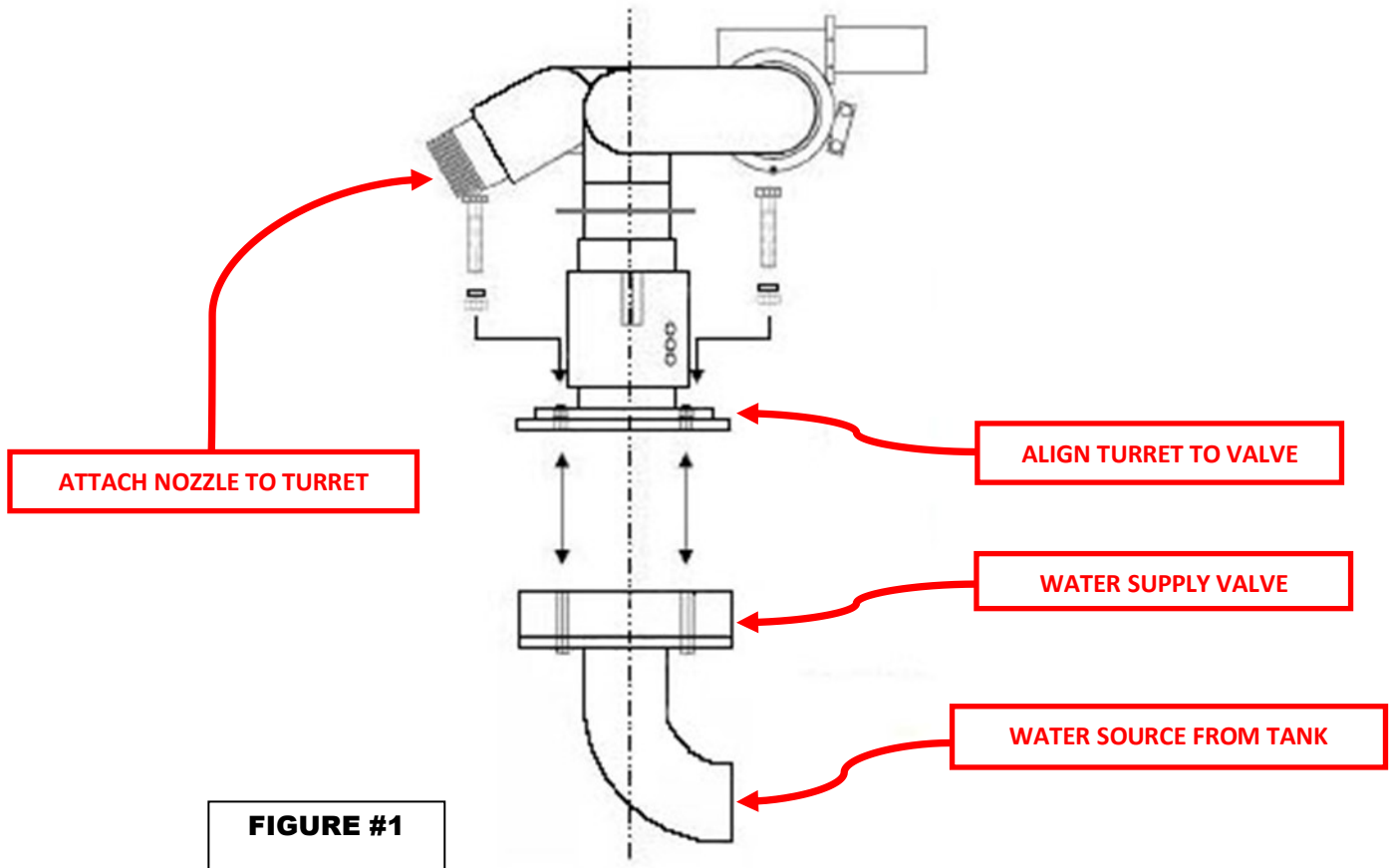

TURRET INSTALLATION	
1	Remove Turret from shipping container, check that all components are in container: Turret, Control Panel, Nozzle and Interconnecting Cable.
2	Mount Turret as shown in Figure #1 on Pipe Flange from Tank Piping.
3	Locate the Control Panel in the cab where operator can access the controls easily.
4	Attach power cable from Control Panel to proper power source.
5	Connect Interconnecting Cable to Control Panel and route the Cable to Turret and connect.
6	Turn on Main Power Source to Control Panel and switch on the Power Switch on the Control Panel. Have someone watch Turret movement while the Joystick on the Control Panel is moved to check movement of Turret in all directions, so Stop Bolts on the Turret can be adjusted to stop Turret to avoid hitting any obstructions during operation of Turret.

TURRET DETAIL

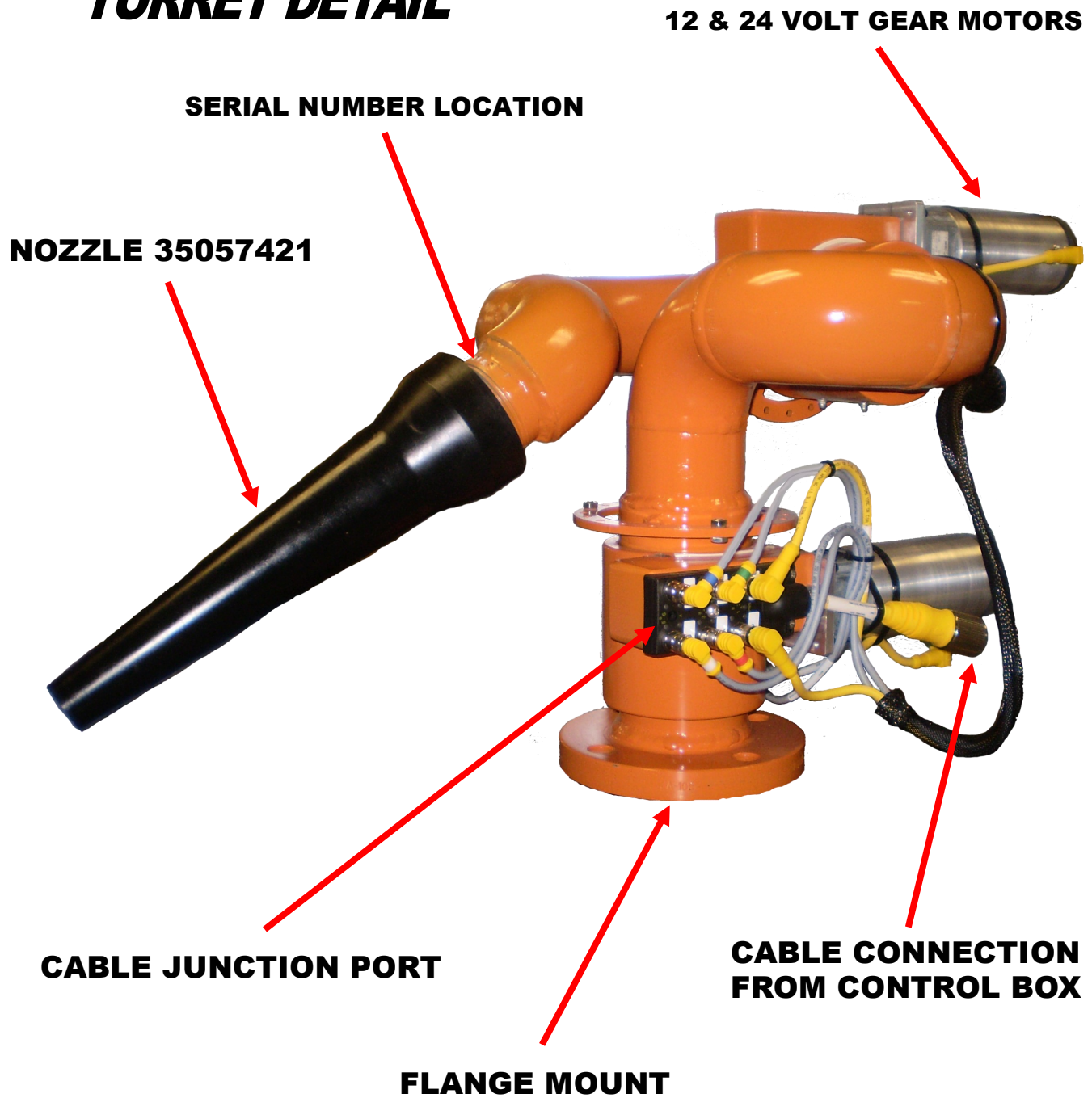

**WATER CANNON UPGRADE
NEW CABLE JUNCTION PORT
PART #91000470003-KIT WITH WIRING HARNESS**

TURRET DETAIL

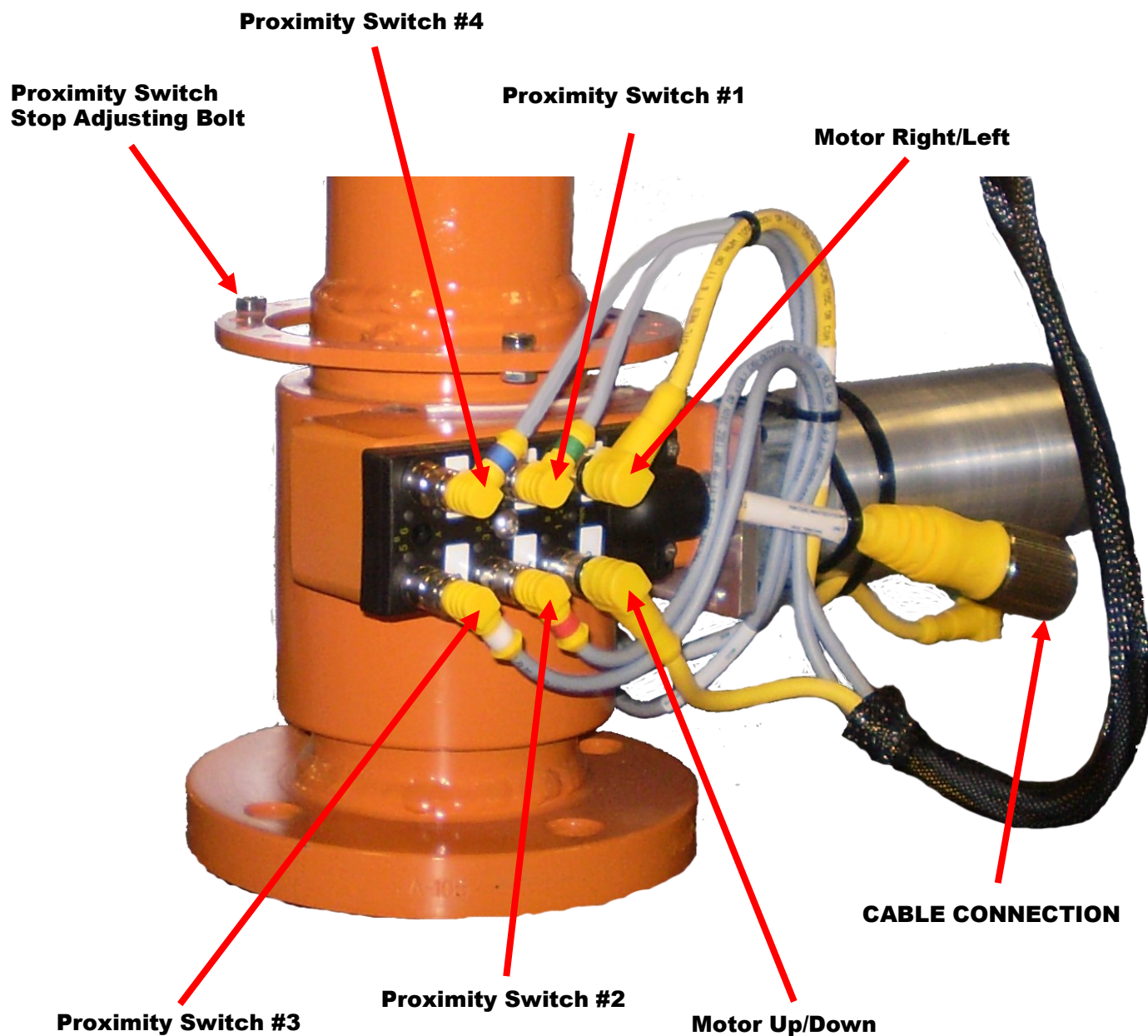

TURRET DETAIL

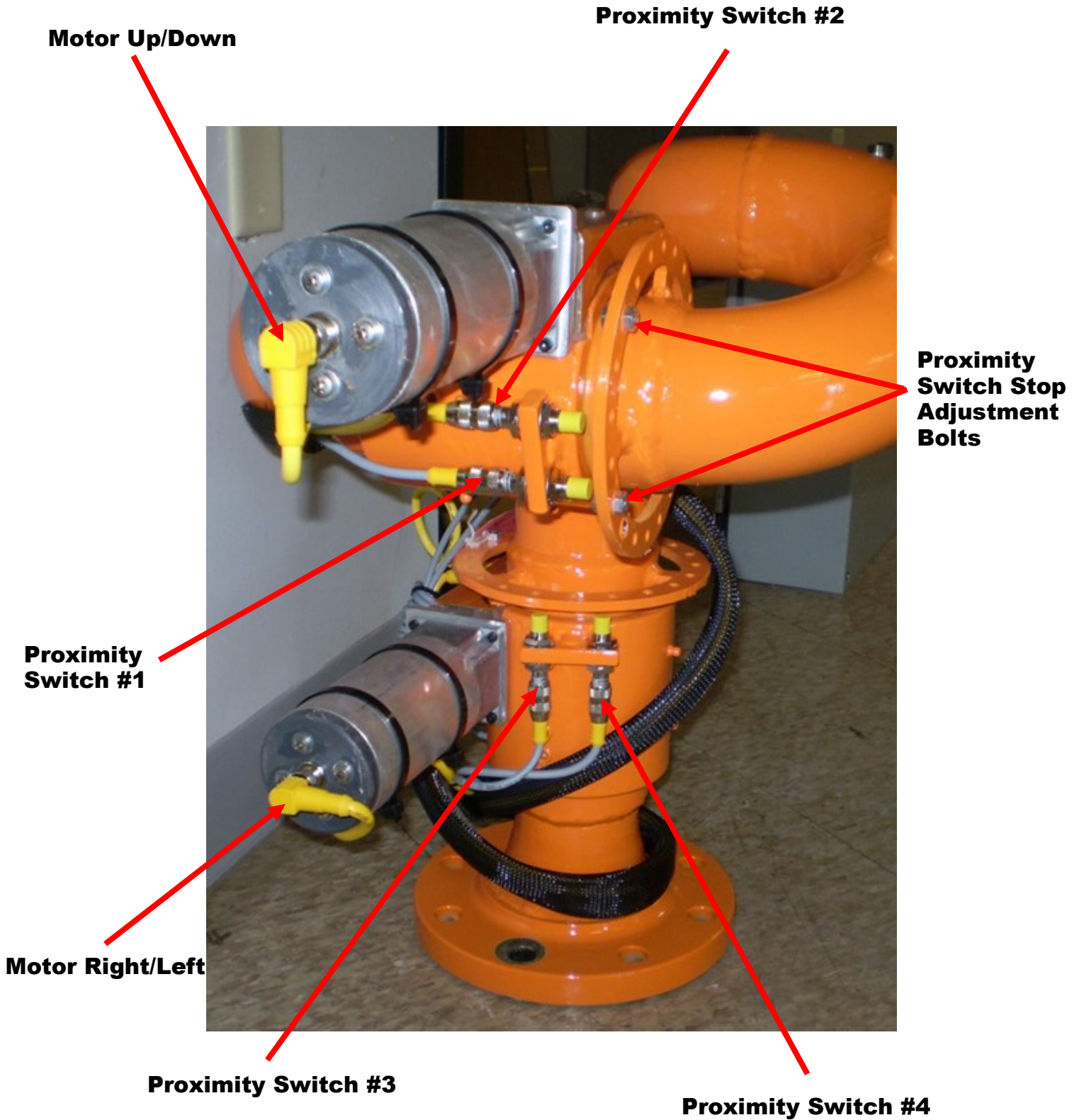

ADJUSTING THE WATER CANNON

CHECK TURRET ROTATION IN ALL DIRECTIONS TO BE SURE TURRET STOPS ARE SET SO TURRET WILL NOT COME IN CONTACT WITH ANY OBJECTS OR WATER FLOW WILL NOT AFFECT ANYTHING

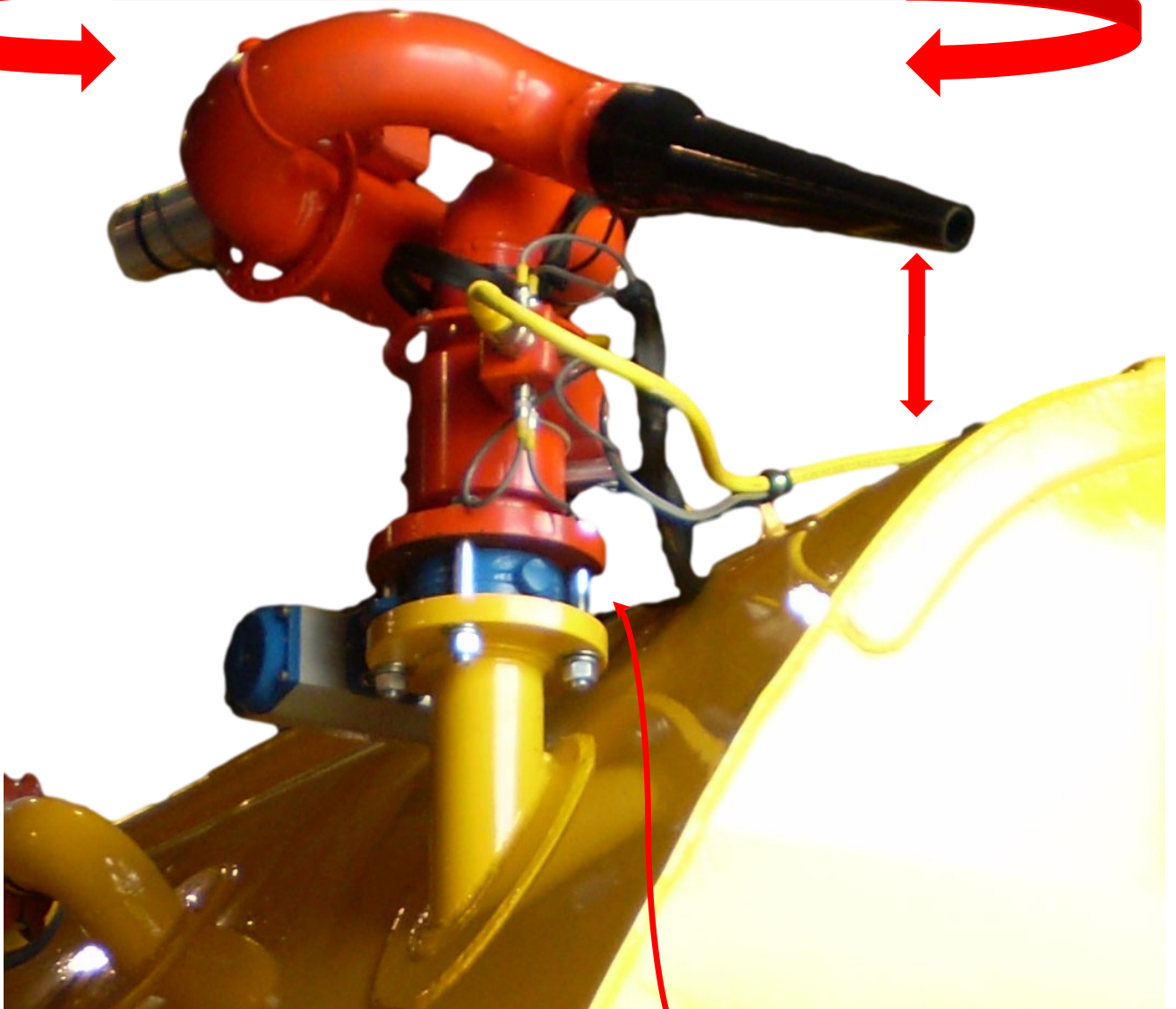

AFTER USE THIS VALVE CLOSES AND WILL TRAP WATER IN THE TURRET. IT MUST BE REOPENED WITH WATER PUMP OFF TO DRAIN WATER FROM TURRET SO WATER WILL NOT FREEZE IN TURRET.

WATER CANNON MAINTENANCE

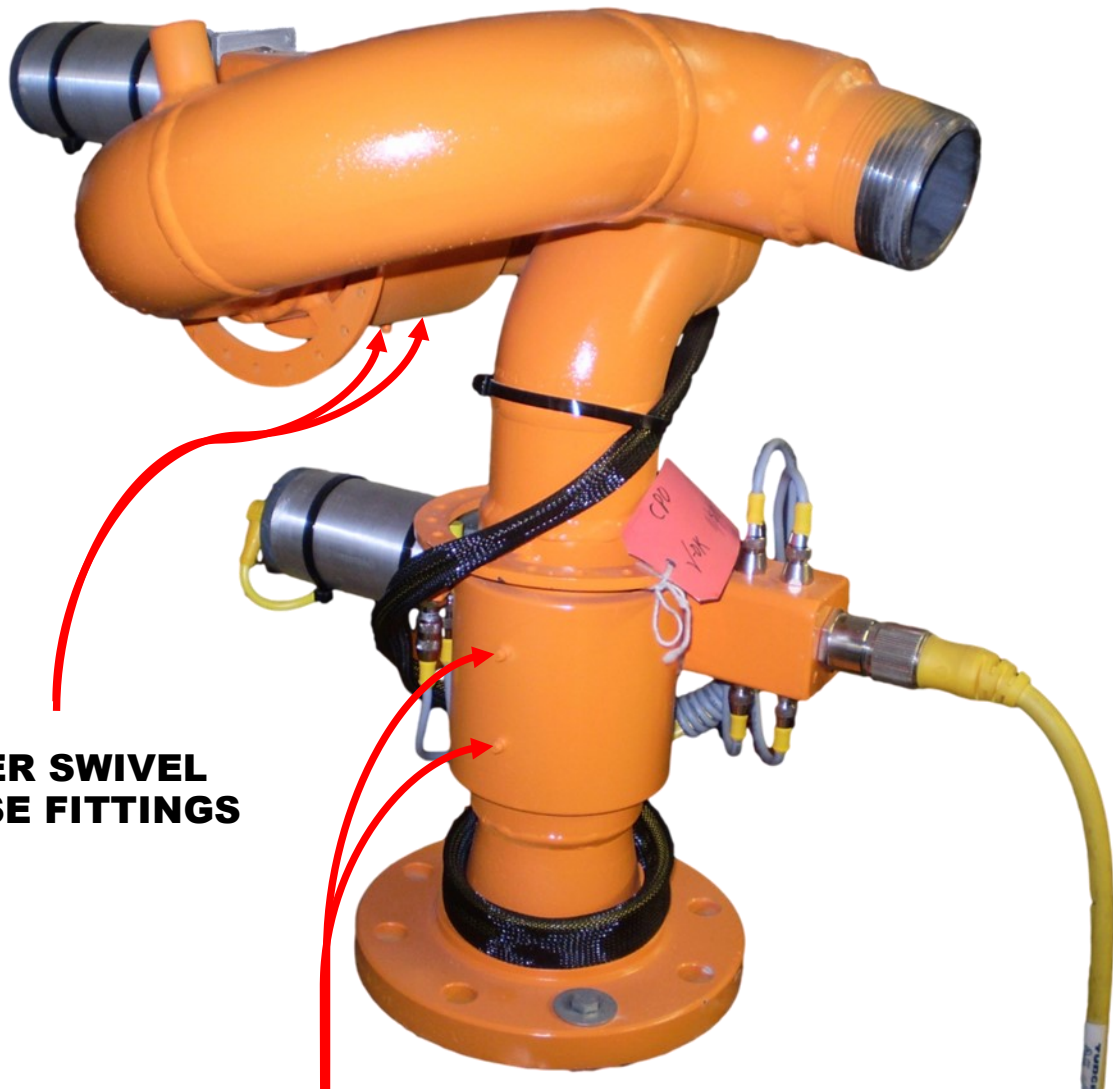

**UPPER SWIVEL
GREASE FITTINGS**

**LOWER SWIVEL
GREASE FITTINGS**

**GREASE TURRET MONTHLY WITH PROPER GREASE
RECOMMENDED GREASE LUBRIPLATE 1200-2 WHITE LITHIUM GREASE**

CONTROL PANEL DETAIL

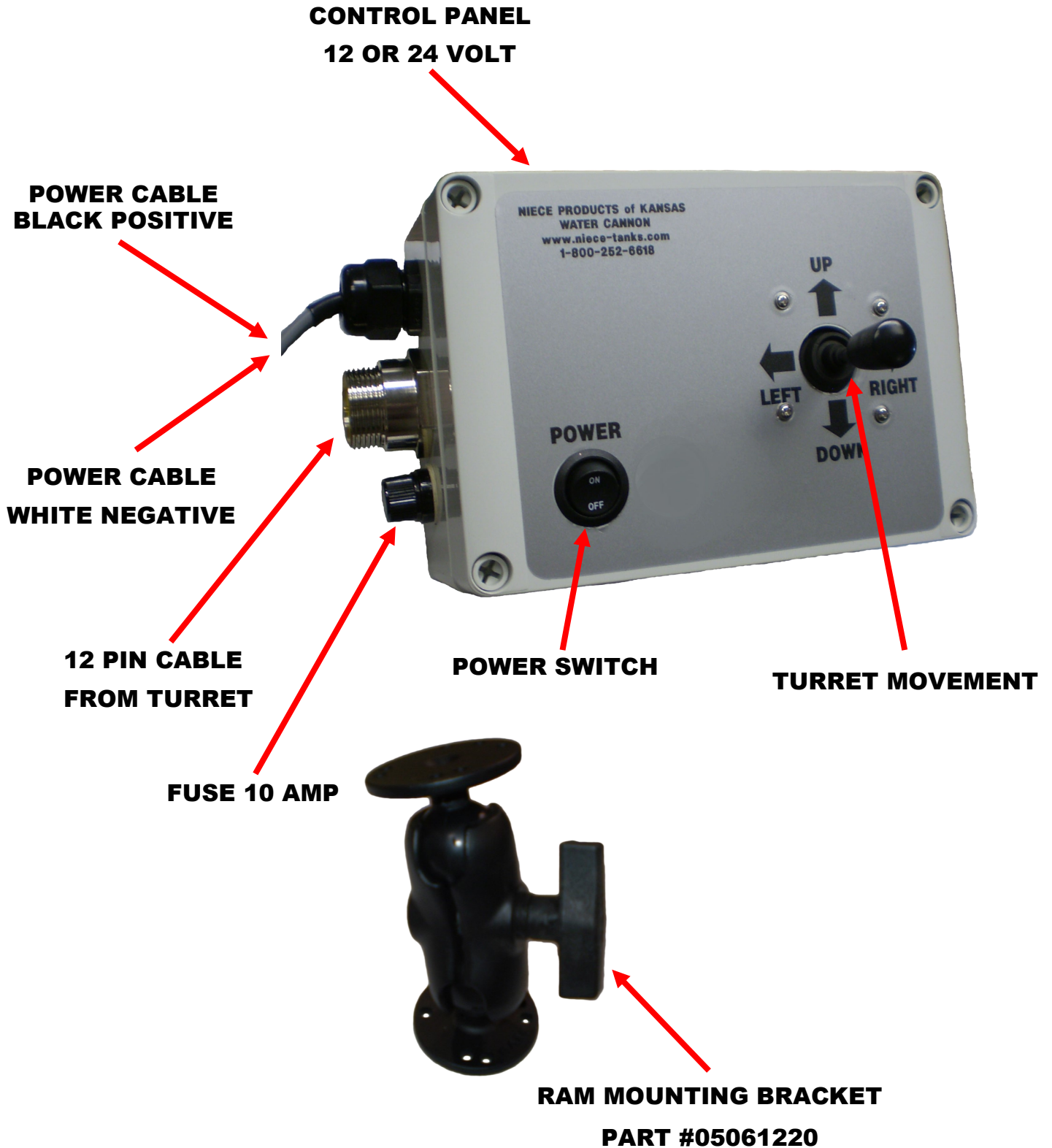

Control Box Wiring

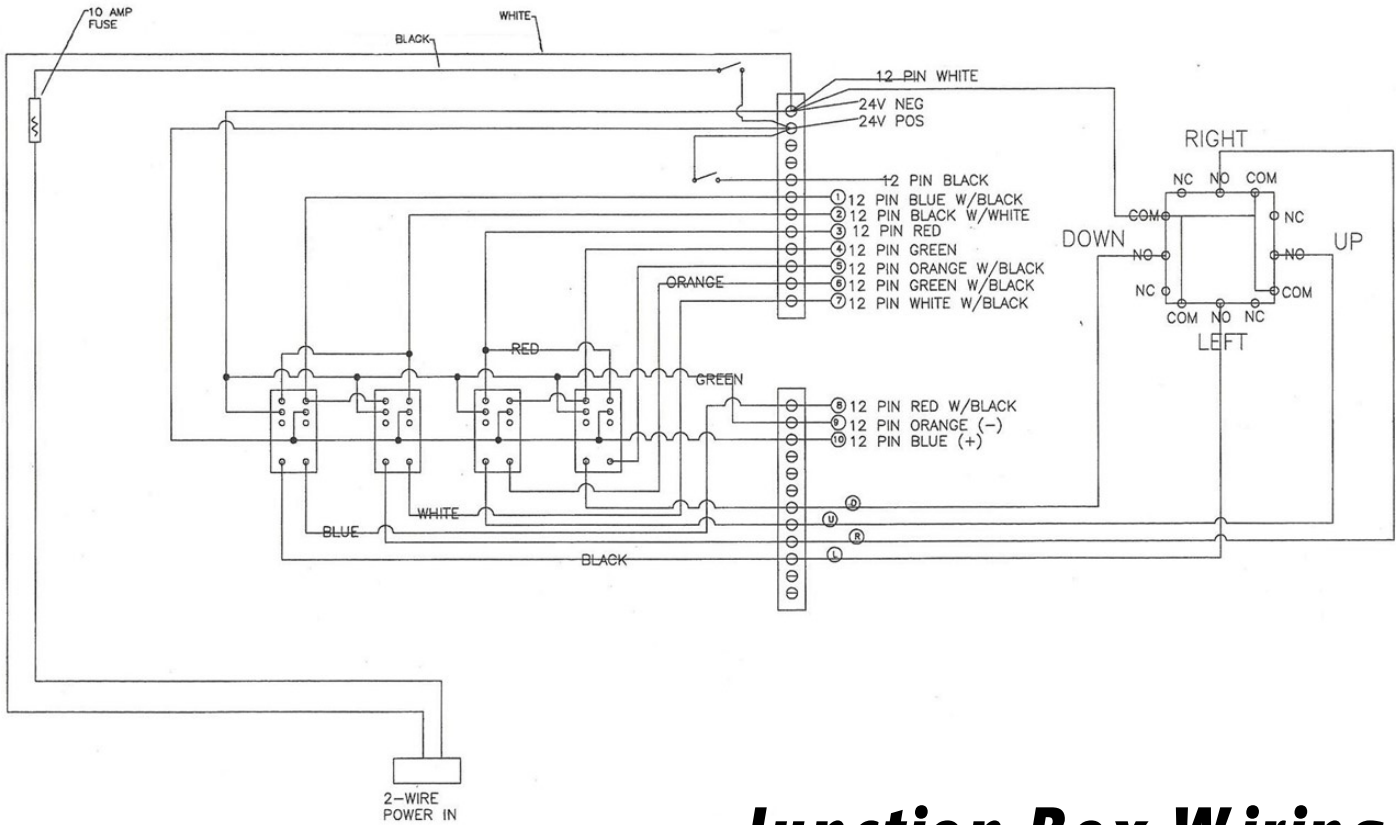

Junction Box Wiring

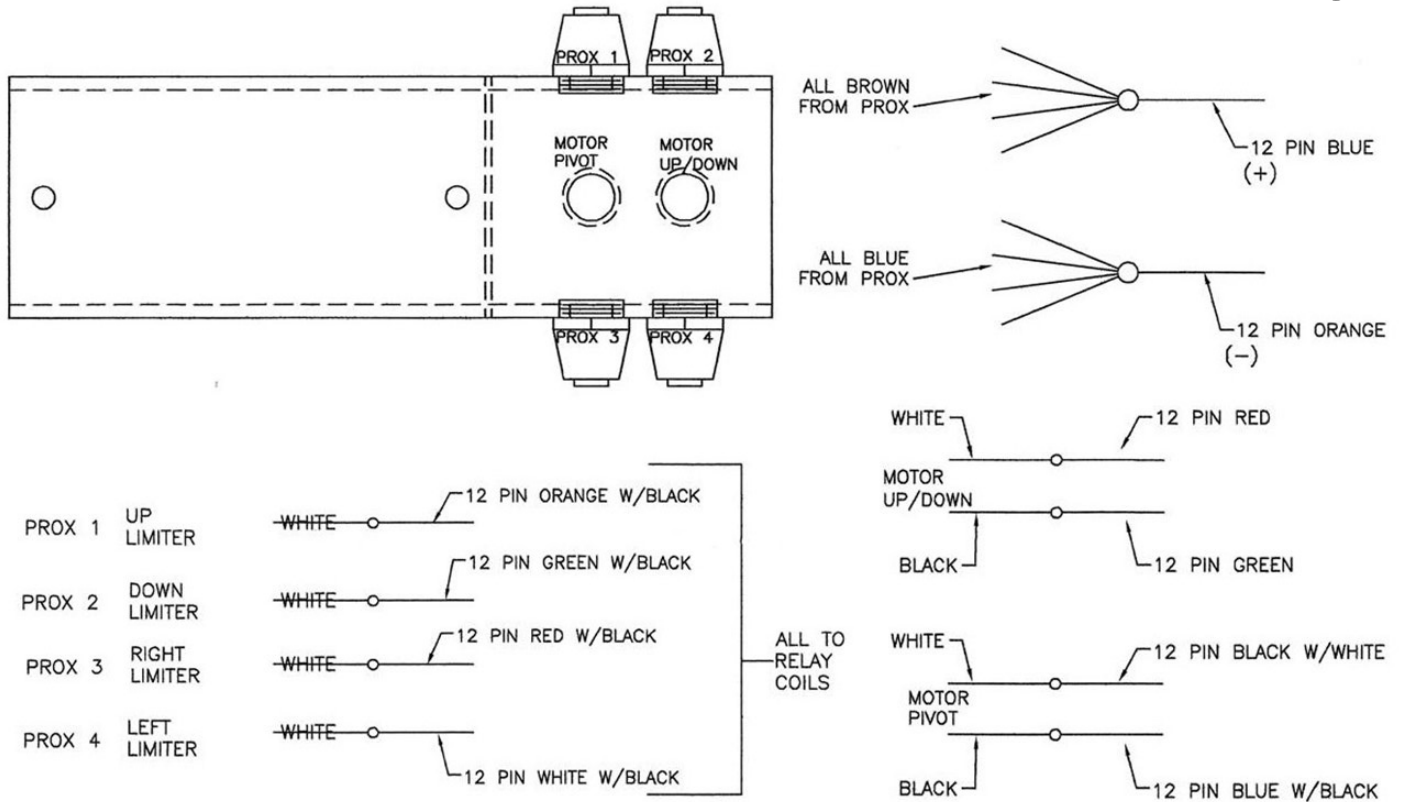

WATER CANNON	TROUBLESHOOTING	
SYMPTOM	CAUSES	FIXES
CONTROL PANEL NOT OPERATING	A) NO POWER B) BLOWN FUSE C) CABLE CONNECTIONS D) NO OPERATING SOUNDS FROM CONTROL PANEL	A) TURN ON POWER SWITCH CHECK MAIN POWER SOURCE B) REPLACE FUSE IN CONTROL PANEL C) CHECK ALL CABLE CONNECTIONS FOR DAMAGE OR TIGHTENING
JOYSTICK CONTROL NOT OPERATING	A) CONTROL PANEL NOT OPERATING (SEE ABOVE) B) JOYSTICK WILL NOT WORK	A) SEE FIXES FOR CONTROL PANEL B) CALL SERVICE LINE (800-252-6618)
TURRET NOT FUNCTIONING	A) CONTROL PANEL NOT WORKING B) BAD CABLE CONNECTIONS C) PROXIMITY SWITCHES NOT WORKING	A) CHECK CONTROL PANEL FIXES B) CHECK ALL CABLES FOR DAMAGE OR BAD CONNECTIONS C) CHECK PROXIMITY SWITCHES WITH FLAT BLADE SCREW DRIVER OR SIMILAR MADE OF METAL BY TOUCHING TOP OF EACH SWITCH TO SEE IF AMBER LED LIGHT ON SWITCH COMES ON, IF NOT REPLACE PROXIMITY SWITCH
TURRET MOVEMENT NOT FUNCTIONING IN UP/DOWN AND/OR RIGHT/LEFT MOVEMENT	A) MOTOR NOT WORKING B) MOVEMENT SLOW AND JERKY	A) REMOVE MOTOR AND CHECK SHEAR PIN, REPLACE IF BAD. IF SHEAR PIN IS GOOD, RECONNECT CABLE TO MOTOR AND MOVE JOYSTICK CONTROL IN THAT AXIS TO SEE IF MOTOR RUNS. IF NOT REPLACE MOTOR WITH THE OPPOSITE MOTOR ON TURRET TO CHECK TO SEE IF THAT MOTOR WILL RUN WITH THAT SAME CABLE. If SECOND MOTOR RUNS REPLACE FIRST MOTOR WITH NEW MOTOR. IF NEITHER MOTOR WILL RUN REPEAT "TURRET NOT FUNCTIONING SYMPTOM". B) REMOVE MOTORS AND WORM SHAFT AND MANUALLY MOVE SWIVEL JOINTS TO CHECK TIGHTNESS. IF SWIVEL MOVEMENT IS TIGHT OR JERKY GREASE SWIVEL UNTIL GREASE COMES OUT OF SWIVEL THROUGH WORM DRIVE OPENING, GREASE UNTIL ALL BAD GREASE IS REMOVED. USE RECOMMENDED WATER PROOF GREASE MONTHLY.

Niece Parts Return Policy

We understand that sometimes there is a need to return a part that is either ordered or shipped in error. It is our intention to make this process as fast and accurate as possible to ensure complete customer satisfaction. To aid in the return process it is most helpful to have the following information at hand:

Your purchase order number, (if applicable)

Niece Invoice number

To return a part, contact the Niece Parts Department via our toll free phone number at 1-800-252-6618; contact us via e-mail at Niece don@niecekansas.com.

Niece will issue you a Return Materials Authorization (RMA) number of which is to be printed on your return shipment package. The RMA will be valid for 30 days from date of issue. Returned parts will not be accepted for credit after the RMA expiration date. Return freight charges are the responsibility of the purchaser.

The return shipment should be sent to the following address:

Niece Products of Kansas, Inc.

3904 Liberty Bell Road

Fort Scott, KS 66701

Returned Parts must meet the following criteria:

Parts must be linked to a sales order or invoice that is within 90 days purchase date

All returned parts must be in acceptable (like new) condition – *Niece reserves the right to refuse return of any part deemed unusable*

No rubber parts or rubber containing parts may be returned

No special order or custom made parts may be returned

Returned parts not included on the RMA will not be accepted or credited

The purchase price of acceptable parts will be refunded as a credit to your account or credit card. Freight charges are not eligible for credit. Credits for acceptable returned parts will be issued within 30 days of receipt of the part.

A 20% restocking fee will be charged for parts returned due to incorrectly ordered parts or parts returned for general reasons. No restocking fee is charged on parts returned due to a misinterpretation made by Niece.

NIECE WEBSITE: www.nieceequipment.com



***Niece Products of Kansas, Inc.
3904 Liberty Bell Road
Fort Scott, Kansas 66701
Toll Free 800-252-6618
don@niecekansas.com***

***Niece Equipment
17401 IH 35 — PO Box 277
Buda, TX 78610
Toll Free 888-643-2372
gilbert@nieceequipment.com***

QUALITY EQUIPMENT FOR ALL YOUR NEEDS

