

MLRK1-DRX

INSERT INSTRUCTIONS

The Command Access MLRK1 is a field installable motorized latch-retraction kit for:

- MRLK1-DRX - Dorex 9500 series devices

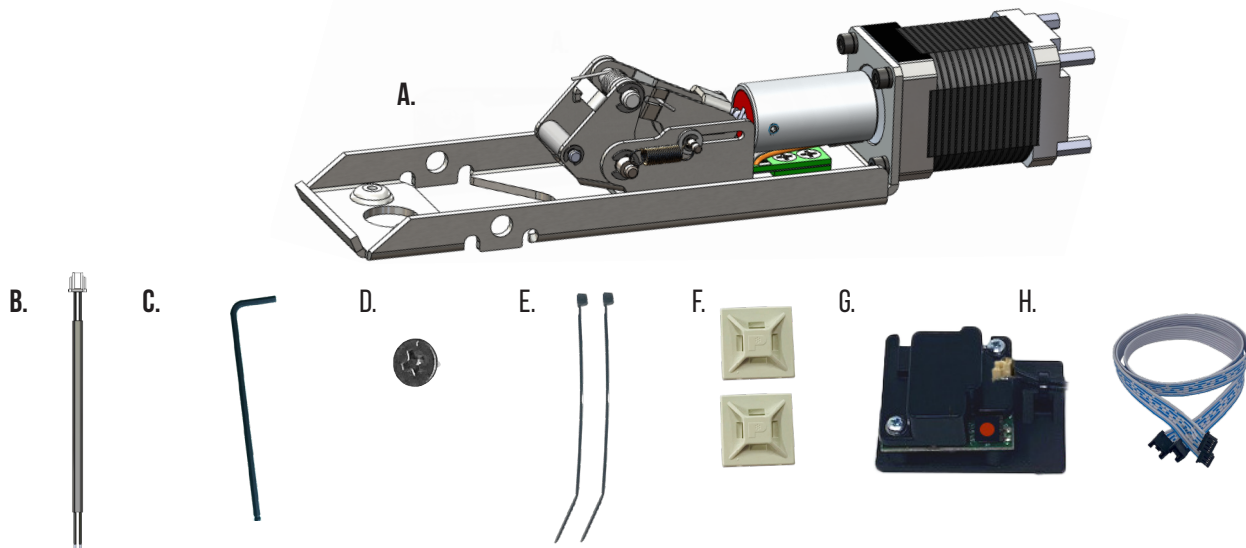

KIT INCLUDES

- | | |
|--------------------------------|---------------------------------------|
| A. 1- MOTOR MOUNT | F. 2- 40059 - MOUNTING PAD |
| B. 1- 50944 - MOLEX PIGTAIL | G. 1- 60373/51186 - REMOTE MM5 MODULE |
| C. 1- 10017 5/64" ALLEN WRENCH | H. 1- 51198 - REMOTE MODULE CABLE |
| D. 2- 40064 - PHILLIPS SCREWS | |
| E. 2- 40060 - CABLE TIE | |



INSTALLATION VIDEO

SPECIFICATIONS

- INPUT VOLTAGE: 24VDC +/- 10%
- AVERAGE LATCH RETRACTION CURRENT: 900 MA
- AVERAGE HOLDING CURRENT: 215 MA
- WIRE GAUGE: MINIMUM 18 GAUGE
- DIRECT WIRE RUN - NO RELAYS OR ACCESS CONTROL UNITS IN-BETWEEN POWER SUPPLY & MODULE

RECOMMENDED POWER SUPPLIES: USE A POWER LIMITED CLASS 2 POWER SUPPLY

ALL COMMAND ACCESS EXIT DEVICES & FIELD INSTALLABLE KITS HAVE BEEN THOROUGHLY CYCLE TESTED WITH COMMAND ACCESS POWER SUPPLIES AT OUR FACTORY. IF YOU PLAN ON USING A NON-COMMAND POWER SUPPLY IT MUST BE A FILTERED & REGULATED LINEAR POWER SUPPLY.

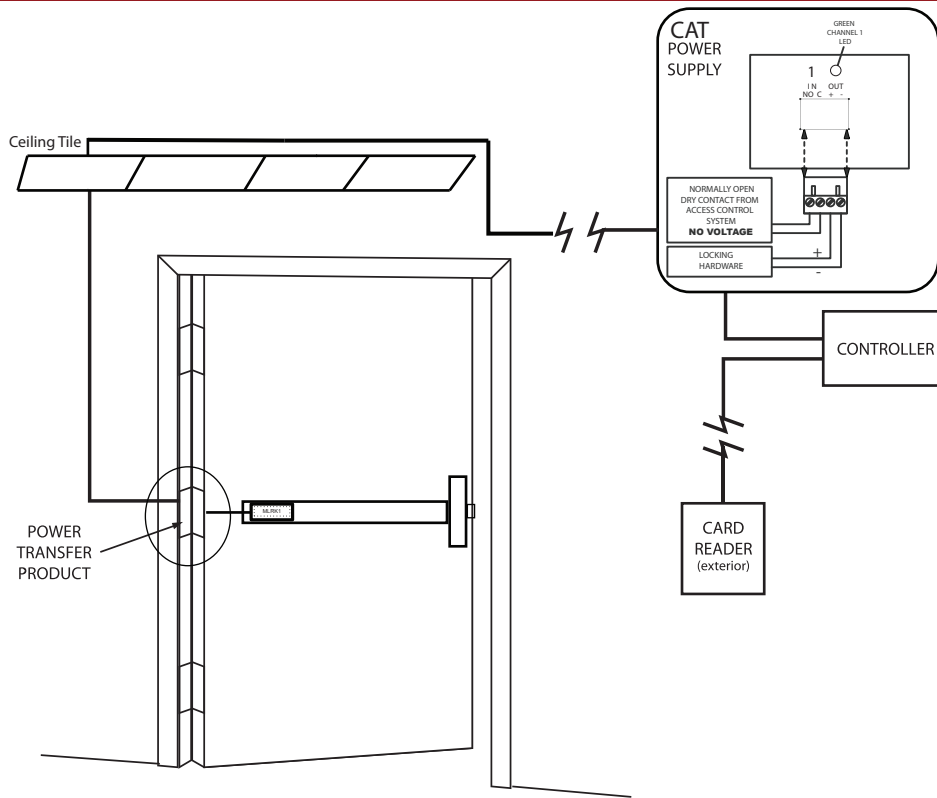

SETTING PUSH TO SET (PTS)

→ **MAKE SURE TO SET PTS BEFORE FINISHING INSTALLATION** ←

- STEP 1 -** TO ENTER PTS MODE: DEPRESS MM5 BUTTON & APPLY POWER. THE DEVICE WILL EMIT 1 SHORT BEEP. THE DEVICE IS NOW IN PTS MODE.
- STEP 2 -** WHILE DEPRESSING THE PUSH PAD, APPLY POWER. (I.E. PRESENTING THE CREDENTIAL TO THE READER).
- STEP 3 -** CONTINUE TO KEEP PAD DEPRESSED, THE DEVICE WILL EMIT 1 LONG BEEP. AFTER THE BEEP HAS STOPPED, RELEASE THE PAD AND NOW THE ADJUSTMENT IS COMPLETE. TEST THE NEW LOCATION, IF NOT TO YOUR LIKING REPEAT THE 3 STEPS.

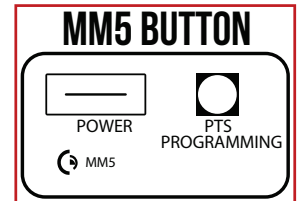

TROUBLESHOOTING & DIAGNOSTICS

BEEPS	EXPLANATION	SOLUTION
2 BEEPS	OVER VOLTAGE	> 30V UNIT WILL SHUT DOWN. CHECK VOLTAGE & ADJUST TO 24 V.
3 BEEPS	UNDER VOLTAGE	< 20V UNIT WILL SHUT DOWN. CHECK VOLTAGE & ADJUST TO 24 V.
4 BEEPS	FAILED SENSOR	VERIFY ALL 3 SENSOR WIRES ARE INSTALLED CORRECTLY. REPLACE SENSOR IF PROBLEM PERSISTS BY CONTACTING OFFICE.
5 BEEPS	RETRACTION OR DOGGING FAILURE	<p>AFTER 1ST FAIL: 5 BEEPS THEN IMMEDIATELY ATTEMPTS TO RETRACT AGAIN.</p> <p>AFTER 2ND FAIL: 5 BEEPS WITH PAUSE IN-BETWEEN FOR 30 SECONDS THEN DEVICE ATTEMPTS TO RETRACT AGAIN.</p> <p>AFTER 3RD FAIL: 5 BEEPS EVERY 7 MINUTES, DEVICE WILL NOT ATTEMPT TO RETRACT.</p> <p>TO RESET: DEPRESS BAR FOR 5 SECONDS AT ANY TIME.</p>

INSTALLATION INSTRUCTIONS

1. Flip over device & remove (4) screws securing push pad assembly to housing.

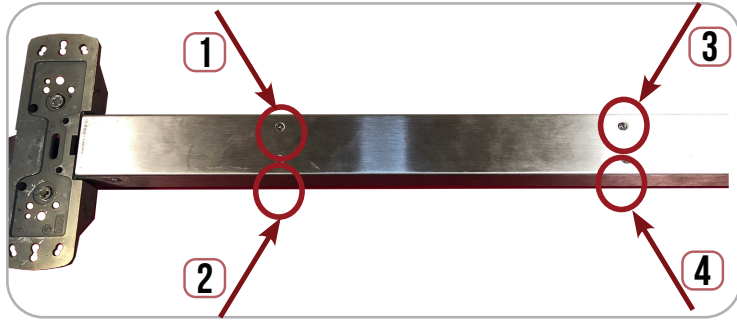

2. Slide Push Pad off Exit Device Housing.

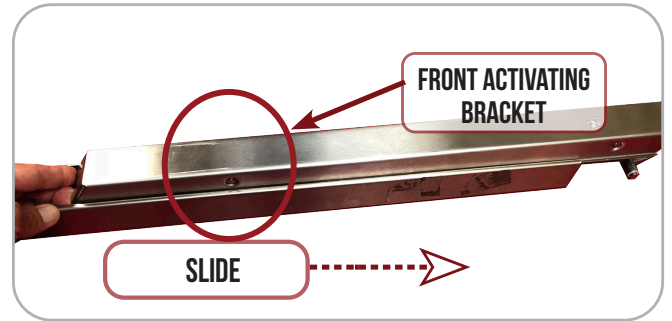

3. Locate the FRONT Activating Bracket. Remove original mounting bracket by pushing out PIN.

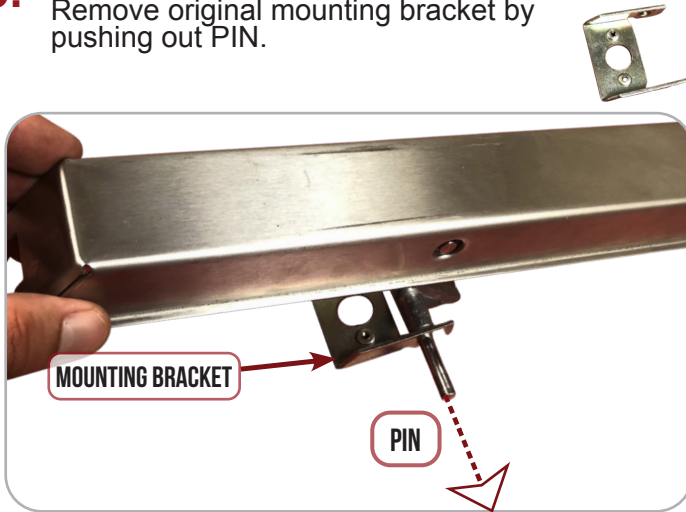

4. Install Point of Front Activating bracket into opening of motor's attaching bracket. It should rest on top of the nylon roller.

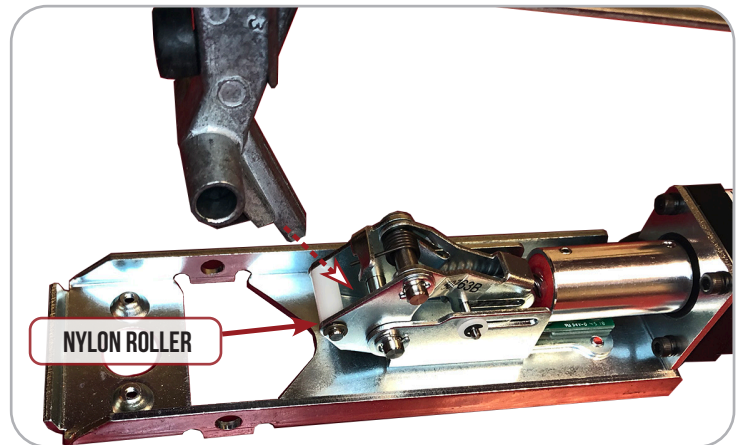

5. Once the point is in the opening, depress the push pad until the holes on the activating bracket & motor mount line up. Re-install factory pin.

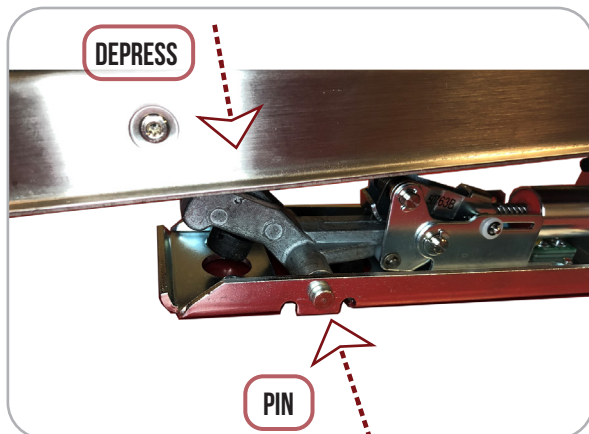

6. Connect MM5 Cable to back of motor's (3) Pin & (4) Pin connectors.

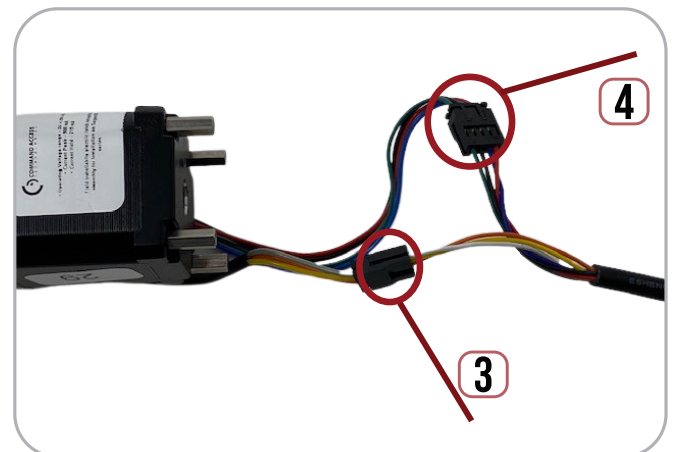

INSTALLATION INSTRUCTIONS

- 7.** Slide Push Pad & Motor Kit back into housing. Be cautious of MM5 cable wires.

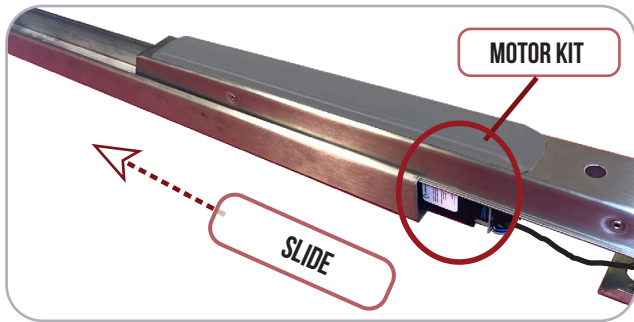

- 8.** Flip Baserail/Pushpad over, holding motor kit in place so it stays attached. **Secure** Motor Kit with (2) M4 Screw provided.

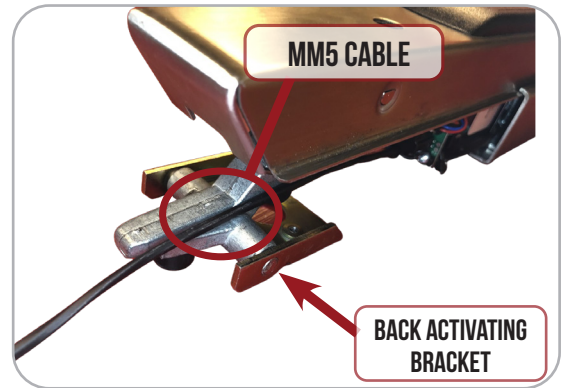

- 9.** Plug-in cable's (4) Pin TOP port & (3) Pin BOTTOM port into MM5 ports.

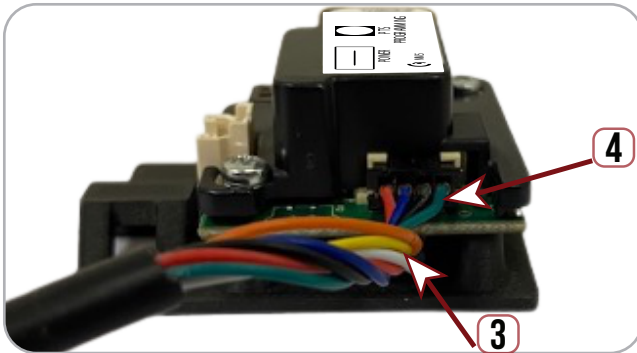

- 10.** Using double sided tape, **secure MM5** to inside of the back of exit device housing. Connect Molex Pigtail. **Add Mounting Pad & cable tie** to secure cable wires.

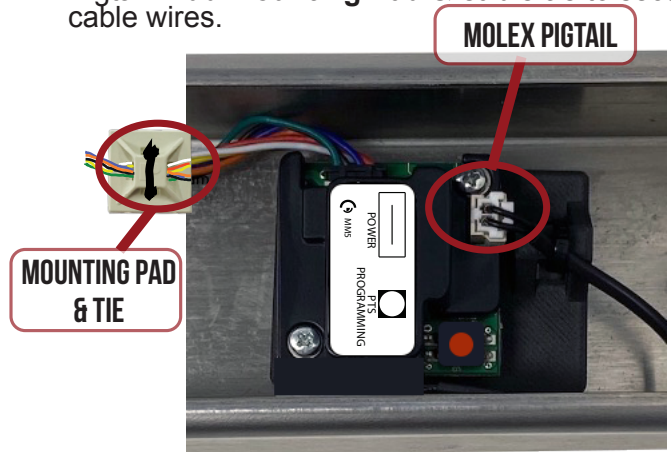

- 11.** Set the "Push to Set Adjustment" following the steps below.



SETTING PUSH TO SET (PTS)

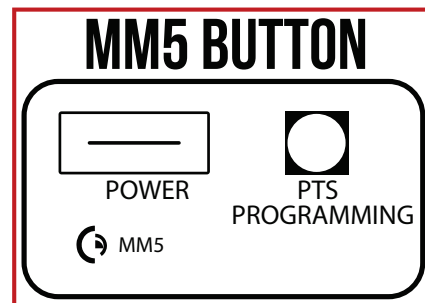

- STEP 1 -** TO ENTER PTS MODE: DEPRESS MM5 BUTTON & APPLY POWER. THE DEVICE WILL EMIT 1 SHORT BEEP. THE DEVICE IS NOW IN PTS MODE.
- STEP 2 -** WHILE DEPRESSING THE PUSH PAD, APPLY POWER. (I.E. PRESENTING THE CREDENTIAL TO THE READER).
- STEP 3 -** CONTINUE TO KEEP PAD DEPRESSED, THE DEVICE WILL EMIT 1 LONG BEEP. AFTER THE BEEP HAS STOPPED, RELEASE THE PAD AND NOW THE ADJUSTMENT IS COMPLETE. TEST THE NEW LOCATION, IF NOT TO YOUR LIKING REPEAT THE 3 STEPS.