

AIPHONE

JOS-1A, JOS-1V, JOS-1F

**HANDS-FREE COLOR VIDEO INTERCOM
 INTERPHONE VIDEO COULEUR MAINS LIBRES
 INTERCOMUNICACIÓN CON VÍDEO A COLOR MANOS LIBRES
 HANDENVRIJE KLEURENVIDEOFONIE
 VIDEOCITOFONO A COLORI A VIVAVOCE
 FREISPRECH-FARBVIDEO-SPRECHANLAGEN-HAUPTSTELLE**

INSTALLATION & OPERATION MANUAL
 MANUEL D'INSTALLATION ET D'UTILISATION
 MANUAL DE INSTALACIÓN Y OPERACIÓN
 INSTALLATIE- EN BEDIENINGSHANDLEIDING
 MANUALE D'INSTALLAZIONE E USO
 INSTALLATIONS- UND BEDIENUNGSANLEITUNGHANDBUCH

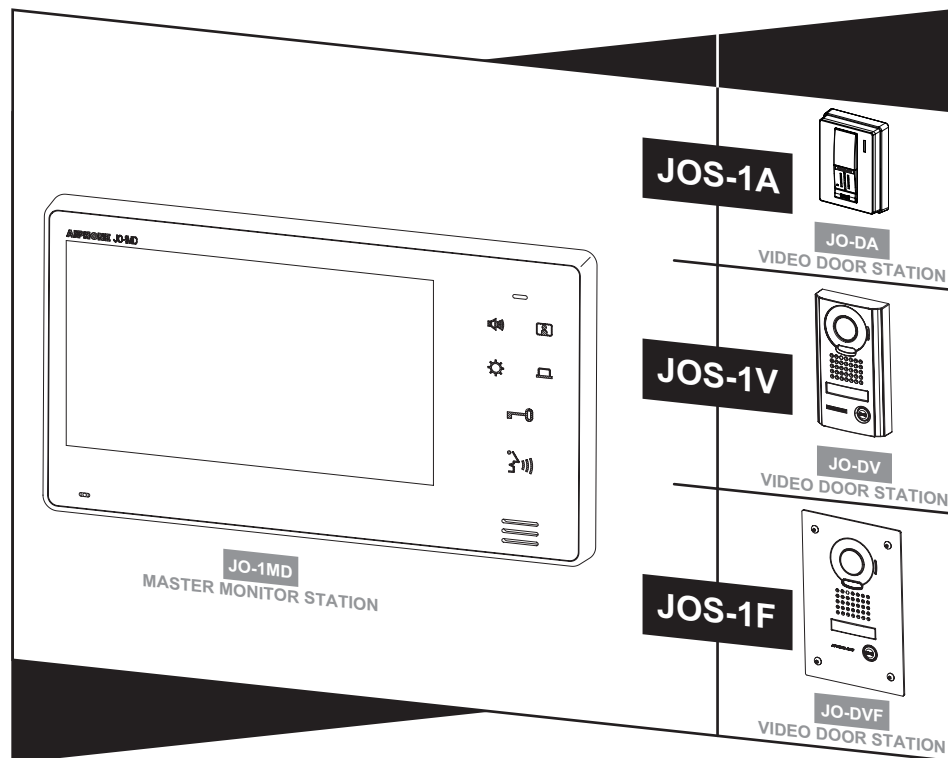

Thank you for selecting Aiphone for your communication and security needs. Please read this manual carefully for proper system operation. For future reference, keep manual in a safe place.

PRECAUTIONS

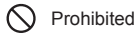

Prohibited



Do not dismantle unit



Keep unit away from water



General precautions

⚠ WARNING

Negligence could result in death or serious injury.

1. Do not dismantle or alter the unit. Fire or electric shock could result.
2. Keep the unit away from water or any other liquid. Fire or electric shock could result.
3. High voltage is present internally. Do not open the case. Electric shock could result.
4. Do not connect any non-specified power source to the +, - terminals. Also, do not install two power supplies in parallel to a single input. Fire or damage to the unit could result.
5. Do not use power supply with a voltage other than specified. Fire or electric shock could result.
6. Do not put any metal or flammable material into the unit through the openings. Fire, electric shock, or unit trouble could result.
7. The unit must be installed and wired by a qualified technician.

⚠ CAUTION

Negligence could result in injury or damage to property.

1. Do not install or make any wire terminations while power supply is plugged in. It can cause electrical shock or damage to the unit.
2. When mounting the unit on a wall, install the unit in a convenient location, but not where it could be jarred or bumped. Injury could result.
3. Before turning on power, make sure wires are not crossed or shorted. Fire or electric shock could result.
4. Do not install the unit in locations subject to frequent vibration or impact. It may fall or tip over, resulting in damage to the unit or personal injury.
5. For power supply, use Aiphone power supply model specified for use with system. If non-specified product is used, fire or malfunction could result.
6. Do not put anything on the unit or cover the unit with cloth, etc. Fire or unit trouble could result.
7. Do not install the unit in any of the following locations. Fire, electric shock, or unit trouble could result.
 - * Places under direct sunlight or near heating equipment that varies in temperature.
 - * Places subject to dust, oil, chemicals, hydrogen sulfide (hot spring).
 - * Places subject to moisture and humidity extremes, such as bathrooms, cellars, greenhouses, etc.
 - * Places where the temperature is quite low, such as inside a refrigerated area or in front of an air conditioner.
 - * Places subject to steam or smoke (near heating or cooking surfaces).
 - * Where noise generating devices such as dimmer switches or inverter electrical appliances are closeby.
 - * Locations subject to frequent vibration or impact.
8. Do not apply high pressure on the screen. If fractured, injury could result.
9. If the LCD is punctured, do not allow skin contact with the liquid crystal inside. Inflammation could result.
 - * If liquid crystal is ingested, immediately gargle with water and seek medical attention.
 - * If contact with the eyes or skin occurs, clean with pure water and seek medical attention.

GENERAL PRECAUTIONS







1. Keep the unit more than 1m (3.3') away from radio or TV set.
2. Keep the intercom wires more than 30cm (12") away from AC 100-240V wiring. AC induced noise and/or unit malfunction could result.
3. Comply with all third party manufacturing specifications that will be used with this system (sensors, door releases, etc.).
4. If the unit is down or does not operate properly, unplug the power supply.
5. When wall-mounted, the top of the unit may darken. This does not indicate a malfunction.
6. The unit case may become warm with use, but this is not a unit malfunction.

7. If the unit is used near a cellular phone, the unit may malfunction.
8. The unit can be damaged if dropped. Handle with care.
9. The unit will not work during power failure.
10. In areas where broadcasting station antennas are close by, the intercom system may be affected by radio frequency interference.
11. All the units, except for door stations, are designed for indoor use only. Do not use at outdoor locations.
12. This product, providing door release, should not be used as a crime prevention device.
13. Please note the LCD panel, though manufactured with very high precision techniques, inevitably will have a very small portion of its image elements always lit or not lit at all. This is not considered a unit malfunction.
14. Environmental sound around the unit may hinder smooth communication, but this is not a malfunction.
15. At night, due to reduced lighting on the object, the screen sees more noise and faces become more difficult to see, but this is not a malfunction.
16. For hands-free communication: If you stand too far away, it may be difficult for the other person to hear the communication.
17. If there are loud noises around the unit (such as music playing or children crying), the sound may break up and be difficult to hear.
18. During communication, if you speak before the other person has finished talking, your voice may not come through clearly. Communication will proceed smoothly if you wait until the other person has finished before speaking.
19. At a gate or porch illuminated by a fluorescent lamp, the image may vary, but this is not a malfunction.
20. The outline of video images displayed by the video door station may differ from that of the actual person(s) or background, but this is not a malfunction.
21. If the surface of a video door station freezes during wintertime, the image may become difficult to see or the call button may not move, but this is not a malfunction.
22. Warm-color lighting shining on the video door station may change the tint of the image on the screen.
23. When outside temperature lowers sharply after rainfall, etc., the inside of the camera may fog up slightly, causing a blurry images, but this is not a malfunction. Normal operation will be restored when moisture evaporates.
24. When the unit's screen is illuminated with strong light, the image looks white or silhouetted, but this is not a malfunction.

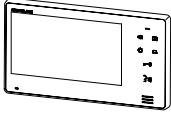
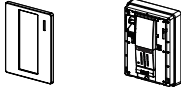
NOTICES

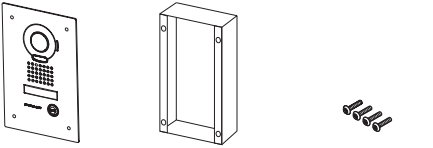
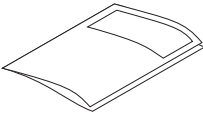
- * We will under no conditions be liable for damage occurring due to the inability to communicate due to malfunctions, problems, or operational errors in this product.
- * We will under no conditions be liable for any damages or losses resulting from this product's contents or specifications.
- * This manual was created by Aiphone Co., Ltd., all rights reserved. Copying, in part or in whole, this manual without prior permission from Aiphone Co., Ltd. is strictly forbidden.
- * Please note that images and illustrations depicted in this manual may differ from the actual ones.
- * Please note that this manual may be revised or changed without prior notice.
- * Please note that product specifications may be changed for the sake of improvement without prior notice.
- * This system is not intended for life support or crime prevention. It is a supplementary means of conveying information. Aiphone will under no conditions be liable for loss of life or property which occurs while the system is being operated.
- * Lighting adjustments are made automatically by the door station. Adjustment results may vary depending on installation environment.

PACKAGE CONTENTS

	JOS-1A	JOS-1V	JOS-1F
 JO-1MD	✓	✓	✓
 Front panel Main unit JO-DA	✓		
 JO-DV		✓	
 Flush mount back box Special screw x4 JO-DVF			✓
 Manual	✓	✓	✓
 Special screwdriver		✓	
 Special screwdriver (Hexagonal wrench)			✓
 Transparent name plate x2		✓	✓

NOTES:

- Mounting and Wood mounting screws not included
- For details on the power supply, see the installation manual separately.

English

Français

Español

Nederlands

Italiano

Deutsch

PART NAMES

Remove protective film before use.

JO-1MD

Color LCD screen

Displays camera images during door station call-ins, communication with door station, and door station monitoring

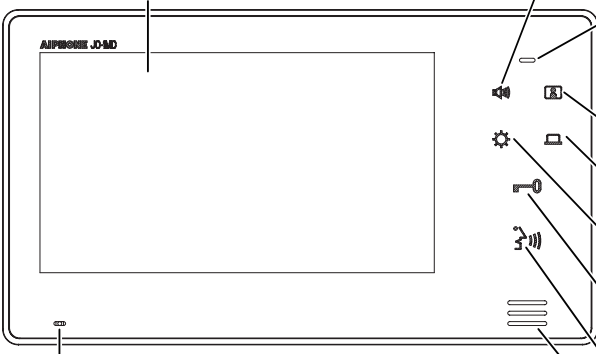

Microphone

Sends sounds from this station to other stations.

RESET button

Press this button to reboot this station when it is not responding.

Volume control button

[During standby]
Adjust the calling volume.
Volume adjustment range: (mute), [During communication or monitoring]
Adjust the communication volume.
Volume adjustment range:

Status LED (orange)

Indicates the current status of this station by lighting up or blinking.
On: During communication sending, while the door release button is being pressed, or while the option button is being pressed
Flashing: During communication reception in the PTT mode, during short detection or during mute

Monitor button

Monitor a door station

Option button

To activate/trigger external device

Screen brightness control button

Adjusts LCD screen brightness
Brightness adjustment range:

Door release button

Unlocks door

Talk/off button

Starts or ends communication.

Speaker

Call tones, sounds from a door station.

[Bottom View]

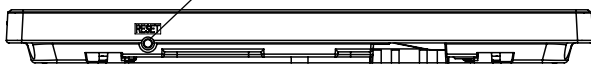

Camera-angle adjustment switch

The camera-angle adjustment switch is behind the panel. Pushing the button changes the angle of the camera.

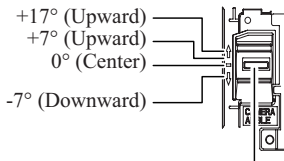

Camera-angle adjustment switch

JO-DA

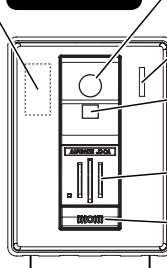

Drainage holes

These are for discharging rain water inside the unit.
Do not obstruct these holes.

Camera

Captures images to display on the screens of the master and expansion monitor station.

Microphone

Sends sounds from the door station to the master and expansion monitor station.

Illumination sensor

Detects outside illuminance to recognize whether it is daytime or nighttime.

Speaker

Outputs sounds from the master or expansion monitor station.

Call button with white light LED

Calls the preset master and expansion monitor station.
Lights up automatically when it gets dark around this station.

JO-DV

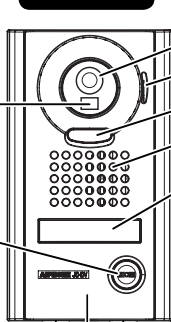

Vandal resistant front panel

Camera

Microphone

White light LED

Speaker

Name plate (with backlight)

The backlight is always lit while the power is on.

Call button

Drainage holes

JO-DVF

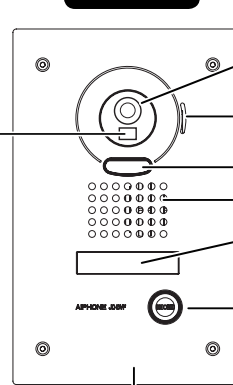

Vandal resistant front panel

Camera

Microphone

White light LED

Speaker

Name plate (with backlight)

Call button

English

Français

Español

Nederlands

Italiano

Deutsch

INSTALLATION

Cable

Use PE (polyethylene)-insulated PVC jacket cable. Parallel or jacketed 2-conductor, mid-capacitance, non-shielded cable is recommended.



Never use individual conductors, twisted pair cable, or coaxial cable.

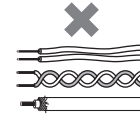

Wiring method, wiring distance

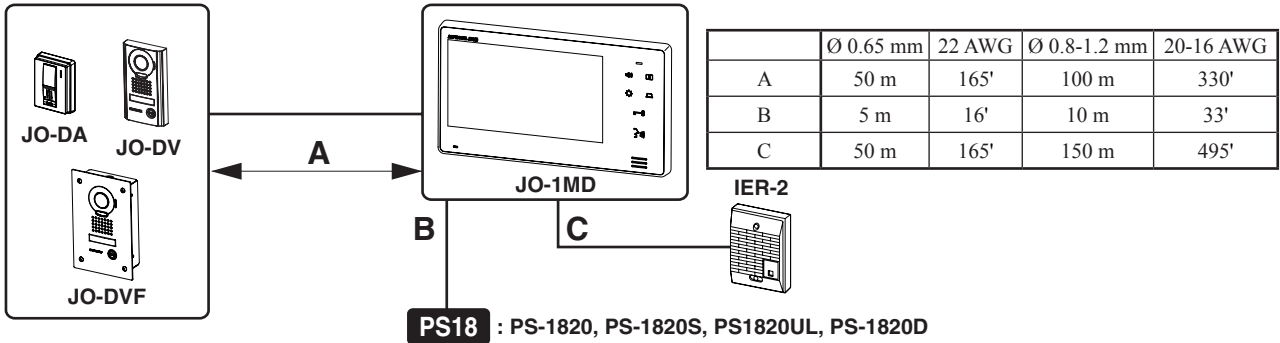

Mounting locations

Do not install door station and master monitor station in any of the following locations where lighting or the ambient environment could impact the display on the video monitor.

JO-DA, JO-DV, JO-DVF

a In direct sunlight

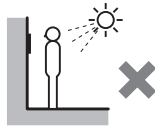

b Under street lights or door lights

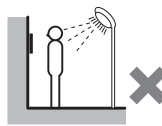

c Other locations subject to strong lighting or backlighting conditions

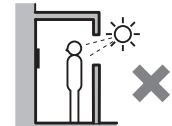

JO-1MD

a In direct sunlight



b Avoid installing the master monitor station in a concave space of a wall to prevent disconnection of communication



c Allow at least 15 cm (6") above and 25cm (9") below center of the mounting bracket for installation of the station

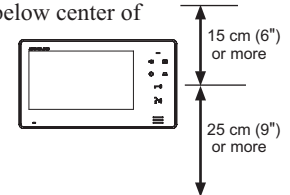

Mounting positions and image view area

JO-DA, JO-DV, JO-DVF

JO-DA: Refer to below diagrams when the camera angle is changed with the adjustment switch.

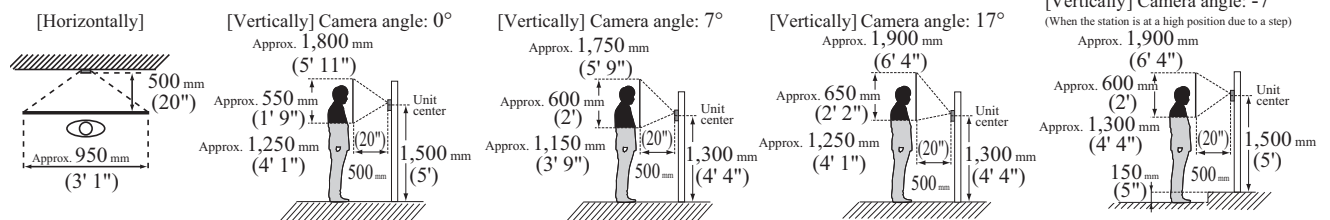

MOUNTING

JO-1MD

<Back wiring>

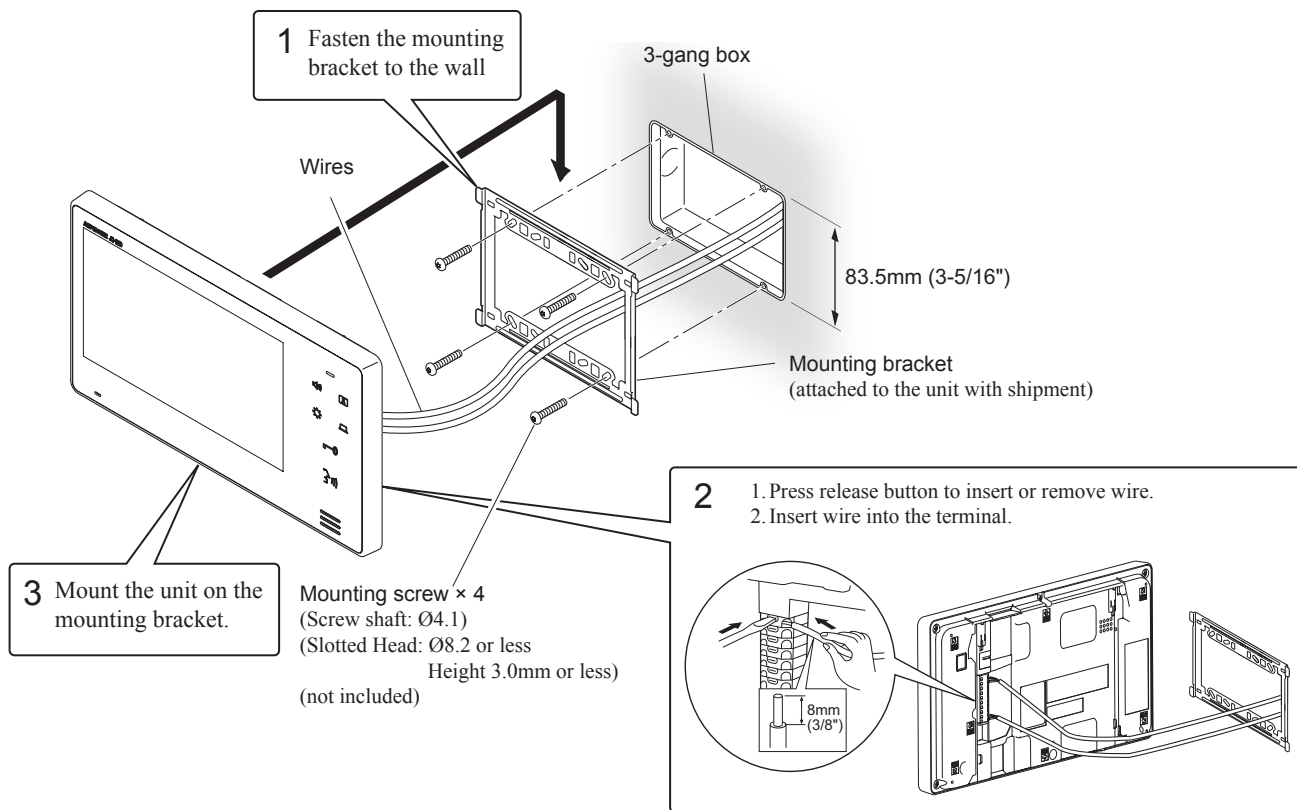

<Surface wiring>

When the wiring is not coming through the wall, the wires can be routed to the top or bottom of the unit. Remove cable inlet plate on the upper part of the unit to allow passage of the wiring into the unit.

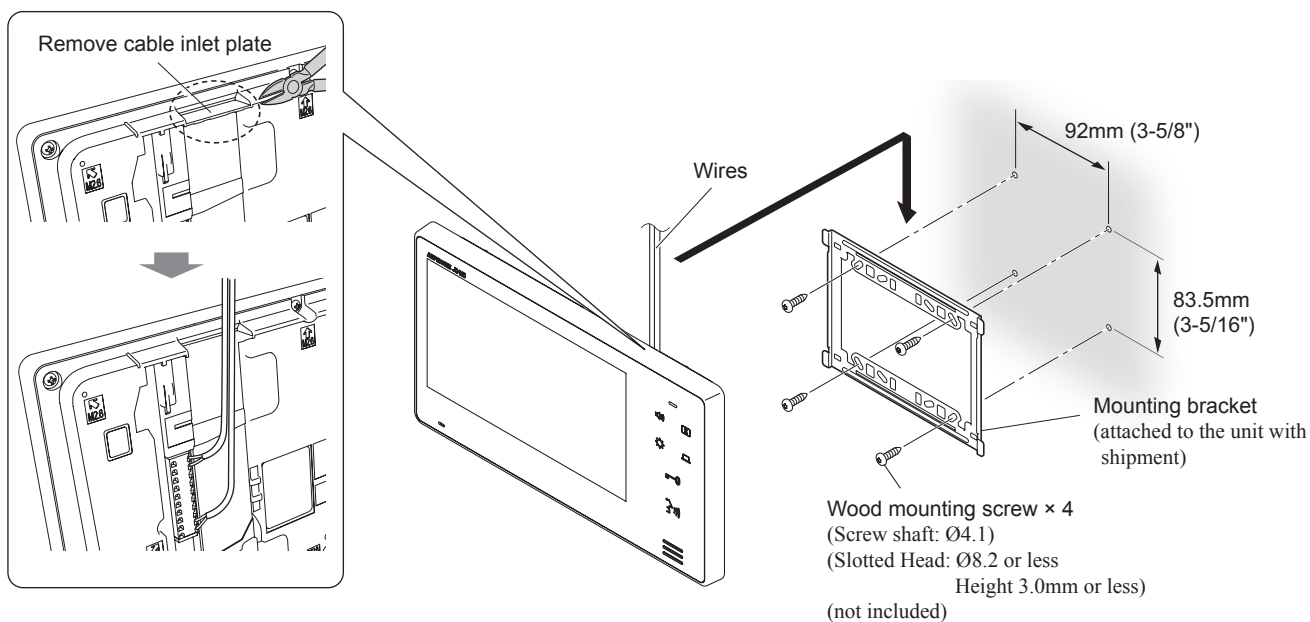

English

Français

Español

Nederlands

Italiano

Deutsch

JO-DA

- 1 Remove the main unit from the mounting frame by loosening the locking screws

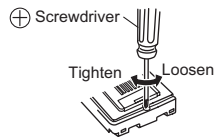

<Back wiring>

Mounting screw x 2
(Screw shaft: Ø4.1)
(Slotted Head: Ø8.2 or less
Height 3.0mm or less)

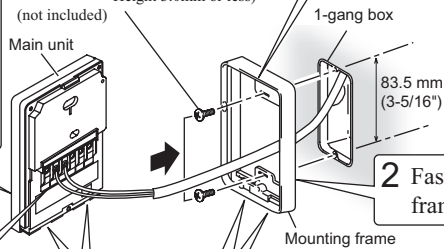

Mount the main unit on the mounting frame, and fit the front panel on.

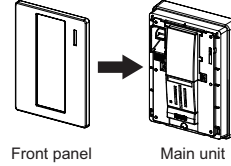

Removing the front panel

<Bottom surface>

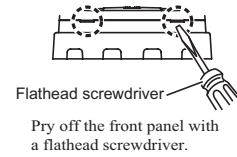

- 2 Fasten the mounting frame to the wall.

Mounting screw x 2
(Screw shaft: Ø4.1)
(Slotted Head: Ø8.2 or less
Height 3.0mm or less)
(not included)

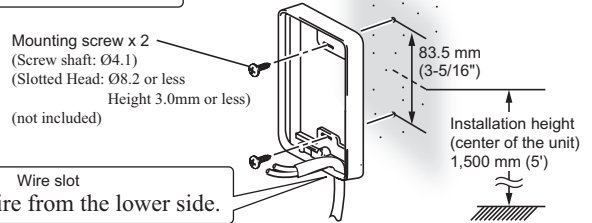

<Surface wiring>

- 3 Connect wires.

Drainage hole
Do not block the holes.

JO-DV

- 4 Fasten the unit to the mounting surface.
*Use board anchors or concrete plugs as needed.

- 1 Loosen the special screw with the special screwdriver, and remove the front panel.

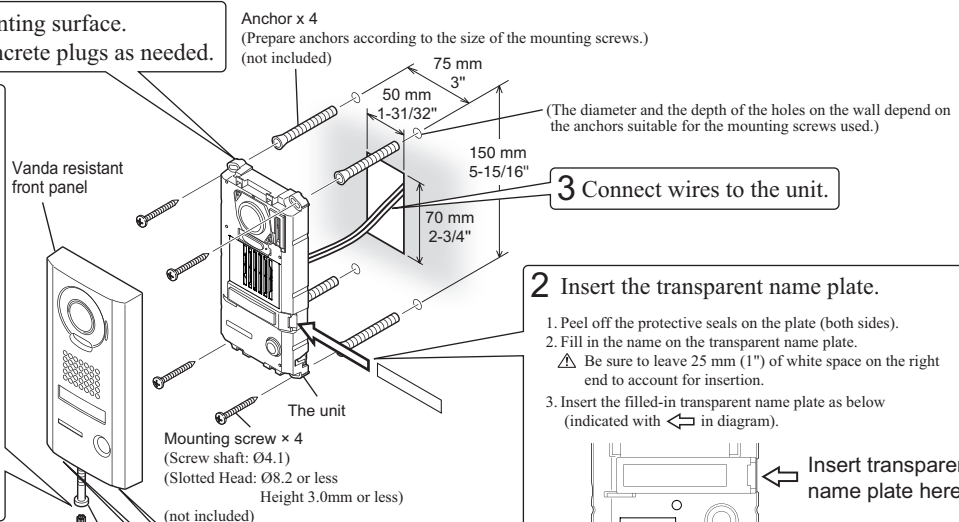
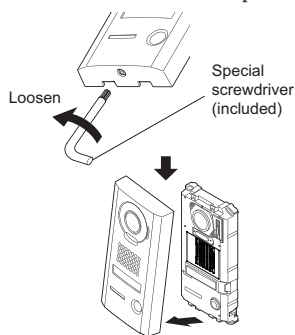

- 3 Connect wires to the unit.

- 2 Insert the transparent name plate.

1. Peel off the protective seals on the plate (both sides).
2. Fill in the name on the transparent name plate.
△ Be sure to leave 25 mm (1") of white space on the right end to account for insertion.
3. Insert the filled-in transparent name plate as below (indicated with ← in diagram).

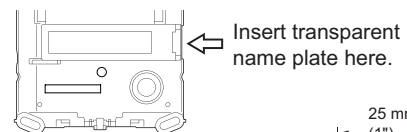

Insert transparent name plate here.

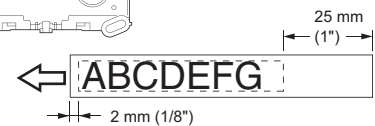

- 5 Replace face plate and tighten special screw with included special screwdriver.

Drainage hole
Do not block the holes.

JO-DVF

- 3 Fasten the front panel to the back box with the special screws.

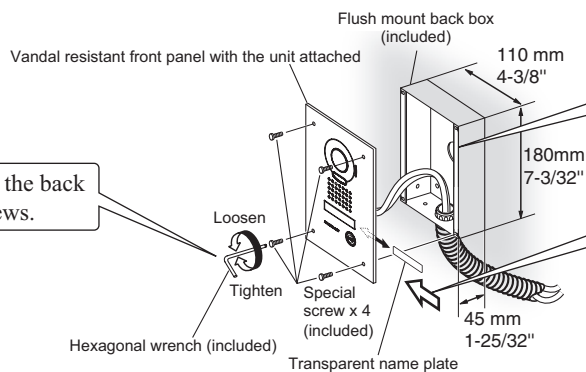

- 1 Install the flush mount back box in the wall, and then connect the wires to the unit with the terminal cover open.

- 2 Insert the transparent name plate.
*See above JO-DV for details.

WIRING

Insert wires securely into each terminal as shown.

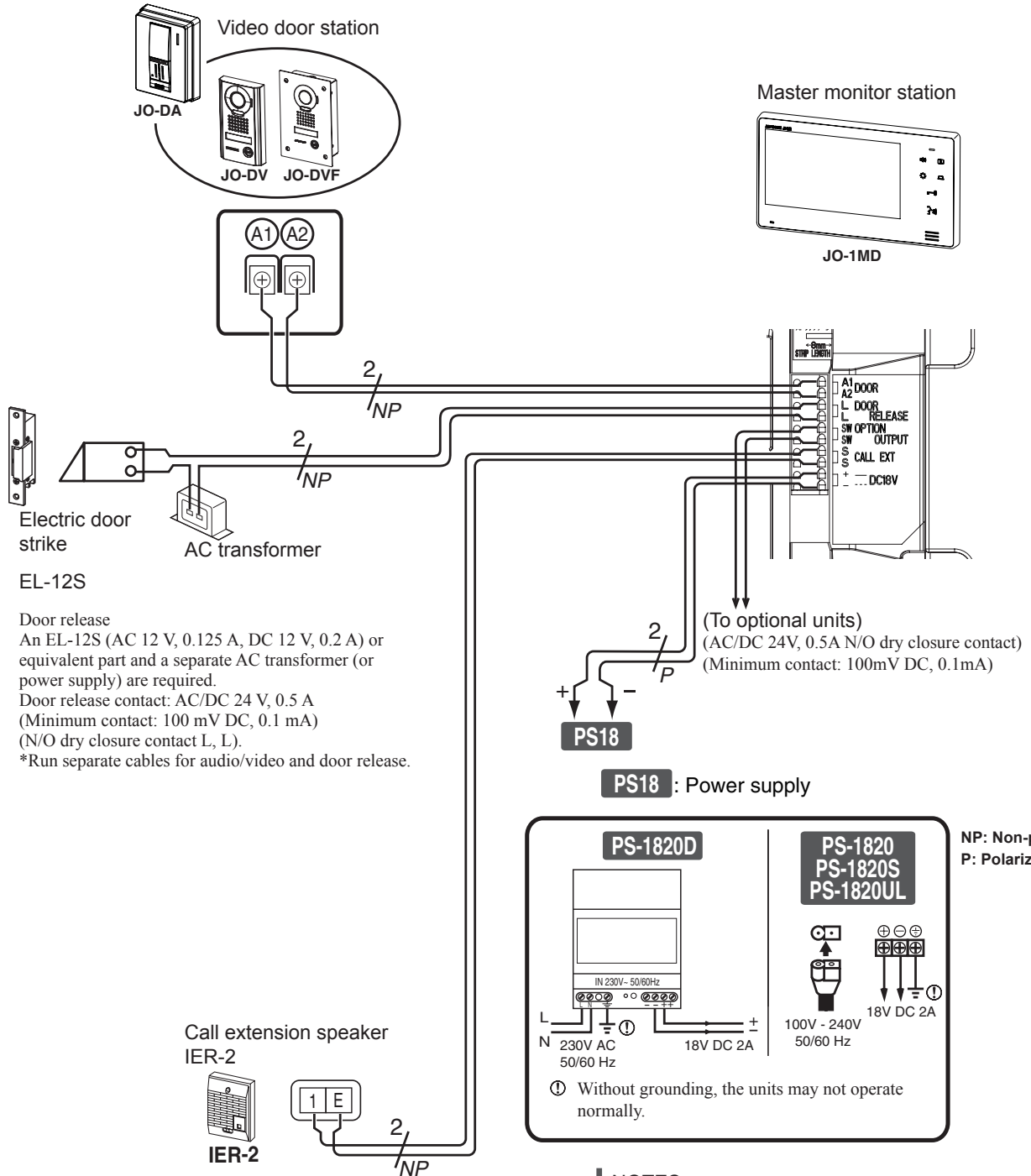

Presence of sound from IER-2
 Call tone from door station.



NOTES:

- To add an expansion monitor station, see the installation manual of the expansion monitor station.



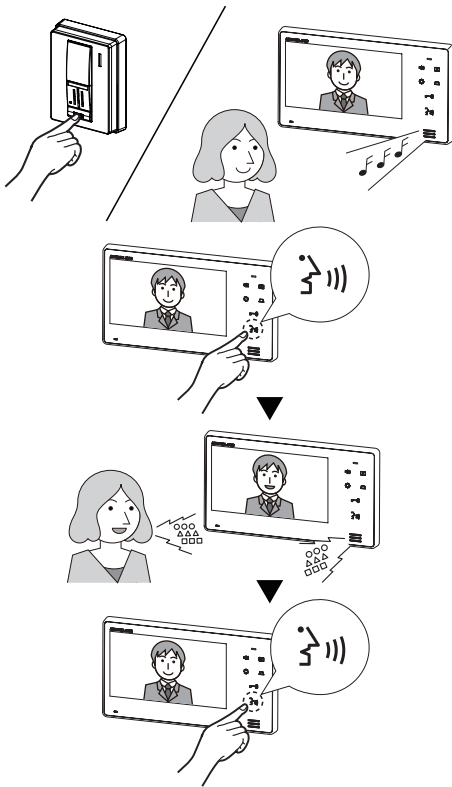

OPERATIONS

Answering a door call



- 1 Push Call button.
- 2 The call tone sounds, an image appears on screen.
 - The screen turns off after approx. 45 seconds if not answered.
- 3 Push , and after the beep, communicate hands-free (hands-free mode).
- 4 After finishing communication, push  and communication will end after the beep.





NOTES:

- Communication ends automatically after approx. 1 minute.
 - The communication volume can be adjusted during the monitoring or the communication by pressing .
- There are three communication volume settings to cycle through: [] (Minimum), [] (Medium), and [] (Maximum). The current volume level is displayed on the screen and disappears in approx. 5 seconds. The default setting is [] (Medium).

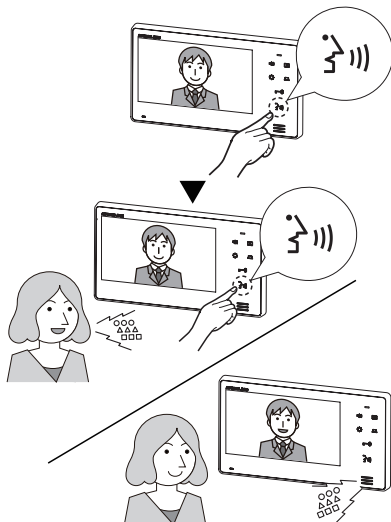
 For loud outdoor areas, use Press-to-Talk mode (PTT)

After 2 seconds or more





- 1 Press and hold  for 2 seconds or more. After approx. 2 seconds beep sounds, PTT mode is engaged.
 - If  is pressed briefly, PTT mode is not engaged.
- 2 When communicating, keep  pressed. To hear the caller's voice, release . Status LED lights when you talk, and flashes slowly as you listen to caller (or hear outside sounds).

NOTES:

- It is not possible to switch back to hands-free mode (from PTT mode during communication).

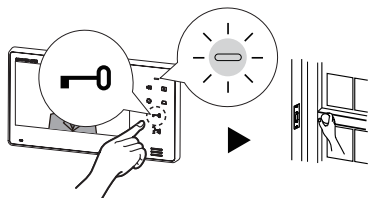
Activating door release



- 1 Press .
- 2 Door release is activated and door can be opened. During release: Status LED lights.

Monitoring door station

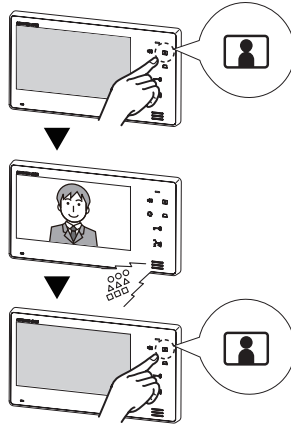

- 1 Push in standby mode.
- 2 The video image from the door station and the incoming audio is heard. If you do not push , the caller will not hear sounds from the inside station.
- 3 Push to end monitoring.

NOTES:

- To talk to door station during monitoring, momentarily push . This allows communication with the door station.
- The monitoring turns off automatically after approx. 1 minute.

Adjust call tone volume

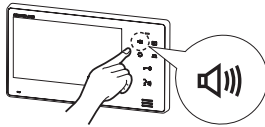

- 1 Push in standby mode to adjust call tone volume and display the volume level.
- 2 Push until the desired call tone volume level is heard.

NOTES:

- There are four call tone volume settings to cycle through: [] (Mute), [] (Minimum) - [] (Maximum). The current volume level is displayed on the screen and disappears in approx. 5 seconds. The default setting is [] (Medium).

Night illumination

At night, the door station White light LED lights up during calling or monitoring door station.

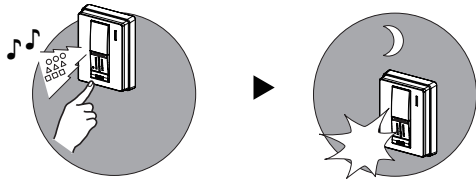

<When a call is made from the door station>

If Call button is pushed, the White light LED lights up.
When communication ends, the White light LED will turn off.

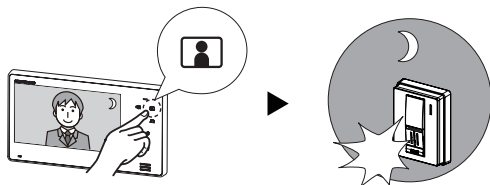

<When the white light LED is lit up during monitoring door station>

When is pushed during monitoring door station, the White light LED will light up.

When monitoring door station ends, the White light LED will turn off.

NOTES:

- The door station evaluates lighting conditions to automatically turn on the white light LED when necessary.

Adjust screen brightness

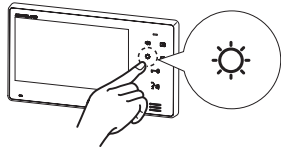

- 1 Push when the screen is difficult to see. The screen brightness changes from [] (the darkest) to [] (the brightest) during communication or monitoring.

NOTES:

- The current brightness level is displayed on the screen and disappears in approx. 5 seconds.
- The default setting is [].

Activating/Triggering external devices (if installed)

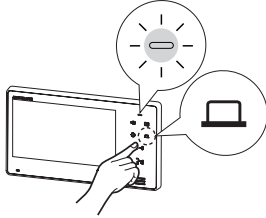

- 1 Press to operate to the unit's option output.

NOTES:

- Optional devices must be installed and connected properly. The can control lights, secondary doors, garages, etc.
- While the button is pressed, the N/O dry closure contact signal is kept being output.

TECHNICAL PRECAUTIONS

Cleaning:

- Clean all units with a soft cloth and gentle cleaner. Do not spray cleaner directly on unit. Do not use an abrasive cleaner or cloth.
- Door stations are weather resistant.

Wiring:

- When a short is detected between A1 and A2 of the door station, the unit stops functioning and the Status LED flashes rapidly until the short is removed. Check the wires.
- If noise is heard from the master monitor station, the wiring is disconnected between the video door station and the master monitor station.

Trouble:

- If the station does not respond, reboot this station by pressing the RESET button.
- When the power supply is turned off, power failure, or the RESET button is pressed, the setting of brightness, communication volume, and call tone volume are returned to the default setting.

SPECIFICATIONS

JO-1MD (Master monitor station)

Power supply	DC 18V (from power supply)
Current consumption	(standby) 24mA (max) 410mA
Communication	Hands-free: Auto-voice actuation PTT: Press-to-talk, release to listen
Ambient temperature	0 - 40°C (+32°F - +104°F)
Monitor	7 inch color LCD screen
Mounting	Wall-mount
Electrical box	3-gang box
Material	Flame resistant ABS resin
Color	White
Dimension	130 (H) x 230 (W) x 21 (D) (mm) 5-1/8 (H) x 9-1/16 (W) x 13/16 (D) (inches)
Weight	Approx. 470g (1.04 lbs.)

JO-DA/JO-DV/JO-DVF (Video door station)

Camera unit	1/4 - inch color CMOS
Ambient temperature	-20 - 60°C (-4°F - +140°F)
Minimum illumination	Approx. 5 lux at 50 cm (1'6") distance
Dimensions	(JO-DA) 129 (H) x 97 (W) x 36 (D) (mm) 5-3/32 (H) x 3-27/32 (W) x 1-13/32 (D) (inches)
	(JO-DV) 173 (H) x 98 (W) x 27 (D) (mm) 6-13/16 (H) x 3-7/8 (W) x 1-3/8 (D) (inches)
	(JO-DVF) 209 (H) x 135 (W) x exposed area 3.5 (D) (mm) 8-1/4 (H) x 5-5/16 (W) x 5/16 (D) (inches)
	(Flush mount back box for JO-DVF) 180 (H) x 110 (W) x 45 (D) (mm) 7-3/32 (H) X 4-3/8 (W) X 1-25/32 (D) (inches)
Weight	(JO-DA) Approx. 200 g (0.44 lbs.) (JO-DV) Approx. 650 g (1.43 lbs.) (JO-DVF) Approx. 580 g (1.27 lbs.)
	(Flush mount back box for JO-DVF) Approx. 550 g (1.2 lbs.)
IP rating	IP54 (JO-DA / JO-DV / JO-DVF)
IK rating	IK08 (JO-DV) IK07 (JO-DVF)

WARRANTY

English

Aiphone warrants its products to be free from defects of material and workmanship under normal use and service for a period of two years after delivery to the ultimate user and will repair free of charge or replace at no charge, should it become defective upon which examination shall disclose to be defective and under warranty. Aiphone reserves unto itself the sole right to make the final decision whether there is a defect in materials and/or workmanship; and whether or not the product is within the warranty. This warranty shall not apply to any Aiphone product which has been subject to misuse, neglect, accident, power surge, or to use in violation of instructions furnished, nor extended to units which have been repaired or altered outside of the factory. This warranty does not cover batteries or damage caused by batteries used in connection with the unit. This warranty covers bench repairs only, and any repairs must be made at the shop or place designated in writing by Aiphone. This warranty is limited to the standard specifications listed in the operation manual. This warranty does not cover any supplementary function of a third party product that is added by users or suppliers. Please note that any damage or other issues caused by failure of function or interconnection with Aiphone products is also not covered by this warranty. Aiphone will not be responsible for any costs incurred involving on site service calls. Aiphone will not provide compensation for any loss or damage incurred by the breakdown or malfunction of its products during use, or for any consequent inconvenience or losses that may result.

The object area of  is the EU.

GARANTÍA

Español

Aiphone garantiza que sus productos están libres de defectos de material y mano de obra, en uso y servicio normal, por un período de dos años después de la entrega final al último usuario y reparará sin costo, o reemplazará sin cargo, si llegara a resultar defectuoso, mediante una inspección que determine que efectivamente está con defecto y en garantía. Aiphone se reserva para sí la facultad única de tomar la decisión final para juzgar si existe una falla en materiales y/o mano de obra, y si el producto está o no cubierto por la garantía. Esta garantía no se aplicará a ningún producto Aiphone que haya sido sometido a maltrato, negligencia, accidente, sobrecarga de energía o que haya sido usado de manera diferente a las instrucciones proporcionadas, o bien por las unidades que hayan sido reparadas o alteradas fuera de fábrica. Esta garantía no cubre baterías o daños causados por baterías usadas en conjunto con la unidad. La garantía cubre solo las reparaciones efectuadas en la mesa de trabajo y cualquier reparación debe ser efectuada en el taller o lugar designado por escrito por Aiphone. Esta garantía se limita a las especificaciones estándar indicadas en el manual de funcionamiento. Esta garantía no cubre ninguna función adicional de un producto de terceros que haya sido añadido por los usuarios o proveedores. Tenga en cuenta que los daños u otros problemas causados por un fallo de funcionamiento o por la interconexión con los productos de Aiphone tampoco están cubiertos por la garantía. Aiphone no se responsabilizará por costos incurridos en cualquier llamada de servicio al sitio mismo en que se presente el defecto. Aiphone no indemnizará por ninguna pérdida o daño en que se incurra debido a la avería o falla de sus productos durante su uso, ni por ningún inconveniente o pérdida que se produzca como consecuencia.

El área de objeto de  es la UE.

GARANTIE

Français

Aiphone garantit que ses produits ne sont affectés d'aucun défaut de matière ni de fabrication, en cas d'utilisation normale et de réparations conformes, pendant une période de deux ans après la livraison à l'utilisateur final, et s'engage à effectuer gratuitement les réparations nécessaires ou à remplacer l'appareil gratuitement si celui-ci présente un défaut, à la condition que ce défaut soit bien confirmé lors de l'examen de l'appareil et que l'appareil soit toujours sous garantie. Aiphone se réserve le droit exclusif de décider s'il existe ou non un défaut de matière et/ou de fabrication et si l'appareil est ou non couvert par la garantie. Cette garantie ne s'applique pas à tout produit Aiphone qui a été l'objet d'une utilisation impropre, de négligence, d'un accident, d'une surtension ou qui a été utilisé en dépit des instructions fournies ; elle ne couvre pas non plus les appareils qui ont été réparés ou modifiés en dehors de l'usine. Cette garantie ne couvre pas les piles ni les dégâts infligés par les piles utilisées dans l'appareil. Cette garantie couvre exclusivement les réparations effectuées en atelier. Toute réparation doit être effectuée à l'atelier ou à l'endroit précisé par écrit par Aiphone. Cette garantie est limitée aux spécifications standard répertoriées dans le manuel d'utilisation. Cette garantie ne couvre pas les fonctions supplémentaires d'un produit tiers ajouté par les utilisateurs ou fournisseurs. Veuillez noter que les dommages ou autres problèmes causés par l'échec de fonction ou interconnexion avec les produits Aiphone ne sont pas non plus couverts par cette garantie. Aiphone décline toute responsabilité en cas de frais encourus pour les dépannages sur site. Aiphone n'indemniserà pas le client en cas de pertes, de dommages ou de désagréments causés par une panne ou un dysfonctionnement d'un de ses produits lors de l'utilisation, ou pour toute perte ou tout problème qui peut en résulter.

La zone d'application de  est l'UE.

WAARBORG

Nederlands

Aiphone waarborgt zijn producten tegen materiaal- en fabricagefouten bij normaal gebruik en onderhoud gedurende een periode van twee jaar na levering aan de eindgebruiker, en zal het product kosteloos herstellen of vervangen indien na onderzoek blijkt dat het toestel een defect heeft dat onder de waarborg valt. Aiphone behoudt zich het recht voor als enige definitief te bepalen of er al dan niet sprake is van een materiaal- en/of fabricagefout en of het product nog onder waarborg is. Deze waarborg geldt niet voor ieder Aiphoneproduct dat is blootgesteld aan verkeerd gebruik, verwaarlozing, een ongeval, stroomstoten, of verkeerde bediening en evenmin voor toestellen die buiten de fabriek zijn hersteld of aangepast. Deze waarborg geldt niet voor batterijen of schade veroorzaakt door batterijen die in het toestel zijn uitgebreid. Deze waarborg dekt uitsluitend werkbankherstellingen en iedere herstelling moet worden uitgevoerd in een schriftelijk door Aiphone aangewezen winkel of werkplaats. Deze waarborg beperkt zich tot de standaardspecificaties die in de bedieningshandleiding staan vermeld. Deze waarborg beslaat geen enkele aanvullende functie van een product van een externe partij dat door gebruikers of leveranciers wordt toegevoegd. Gelieve op te merken dat schade of andere problemen die het gevolg zijn van storing bij gebruik of verbinding met producten anders dan die van Aiphone, eveneens niet door deze waarborg worden gedekt. Kosten die gepaard gaan met herstellingen ter plaatse kunnen niet worden verhaalbaar op Aiphone. Er kan geen schadeloosstelling van Aiphone worden geëist voor enig verlies of schade als gevolg van een defect of storing tijdens het gebruik van zijn producten, of voor enig ongemak of verlies dat hieruit voortvloeit.

Het toepassingsgebied van  is de EU.

GARANTIE

Deutsch

Aiphone garantiert, dass seine Produkte frei von Material- oder Verarbeitungsfehlern sind bei normalem Gebrauch für die Dauer von zwei Jahren nach der Auslieferung an den Endnutzer und wird kostenlose Reparaturen oder Austausche vornehmen, sollte das Gerät einen Defekt aufweisen, der nach eingehender Überprüfung innerhalb der Garantie liegt. Aiphone behält sich das alleinige Recht vor, endgültige Entscheidungen zu treffen, ob ein Defekt am Material und/oder in der Verarbeitung vorliegt, und ob das Produkt innerhalb der Garantie liegt. Diese Garantie trifft auf kein Aiphone-Produkt zu, welches Gegenstand von Missbrauch, Fahrlässigkeit, Unfall und Stromüberladung gewesen ist oder in Verletzung geltender Vorschriften genutzt wurde, und wird nicht auf Geräte ausgeweitet, die außerhalb des eigenen Werks repariert oder verändert wurden. Die Garantie deckt keine Batterien oder Schäden, die durch Batterien in Verbindung mit dem Gerät verursacht wurden, ab. Die Garantie deckt nur Werkstattreparaturen ab und alle Reparaturen müssen in den von Aiphone schriftlich vorgesehenen Geschäften oder Orten durchgeführt werden. Die Garantie ist auf die im Betriebshandbuch angegebenen Standardspezifikationen beschränkt. Die Garantie deckt keinerlei ergänzenden Funktionen von Drittanbieter-Produkten, die vom Nutzer oder Händler hinzugefügt wurden, ab. Beachten Sie, dass jegliche Schäden oder andere Probleme, die durch eine Verwendung des Geräts mit anderen Produkten als Aiphone-Produkten entstehen, nicht von der Garantie abgedeckt sind. Aiphone ist für alle anfallenden Kosten hinsichtlich örtlicher Service-Anrufe nicht verantwortlich. Aiphone bietet keinerlei Kompensation für jegliche Verluste oder Schäden, die aufgrund eines Ausfalls oder einer Fehlfunktion seines Produkts verursacht wurden, noch für etwaige Unannehmlichkeiten oder Verluste.

Das Anwendungsgebiet von  ist die EU.

GARANZIA

Italiano

Aiphone garantisce che i suoi prodotti sono privi di difetti nei materiali o nella lavorazione, in condizioni di utilizzo normali e per un periodo di due anni dalla consegna all'utente finale. Aiphone eseguirà la riparazione o la sostituzione gratuita del prodotto qualora tale prodotto risulti difettoso e la garanzia sia applicabile al difetto rilevato. Aiphone si riserva il diritto esclusivo di stabilire in via definitiva se sono presenti difetti nei materiali e/o nella lavorazione e se il prodotto è coperto dalla garanzia oppure no. La presente garanzia non è applicabile ad alcun prodotto Aiphone che sia stato sottoposto ad uso improprio, negligenza, incidente, sovraccorrente o che sia stato utilizzato in violazione alle istruzioni fornite, né può essere estesa alle unità che sono state riparate o manomesse al di fuori della fabbrica. Questa garanzia non copre le batterie né i danni causati dalle batterie usate in connessione con l'unità. Questa garanzia copre solo le riparazioni del prodotto consegnato presso il punto designato. Le eventuali riparazioni devono essere eseguite presso il punto vendita o il luogo designato per iscritto da Aiphone. Questa garanzia è limitata alle specifiche che standard elencate nel manuale d'uso. Questa garanzia non copre le funzioni supplementari di prodotti di altre aziende aggiunti dagli utenti o dai fornitori. Eventuali danni o altri problemi causati da problemi di funzionamento o interconnessione con prodotti Aiphone non sono coperti da questa garanzia. Aiphone non potrà essere ritenuta responsabile di eventuali costi sostenuti in caso di chiamata per l'assistenza sul posto. Aiphone non offrirà alcun compenso per gli eventuali danni o perdite subiti a causa della rottura o del guasto dei suoi prodotti durante l'uso, o per qualsiasi disagio o perdita conseguente che si dovesse verificare.

L'area oggetto di  è l'UE.

 **AIPHONE**®
Providing Peace of Mind
<http://www.aiphone.net/>

AIPHONE CO., LTD., NAGOYA, JAPAN

Printed in Thailand